

Searching for invisible particles@ LHC

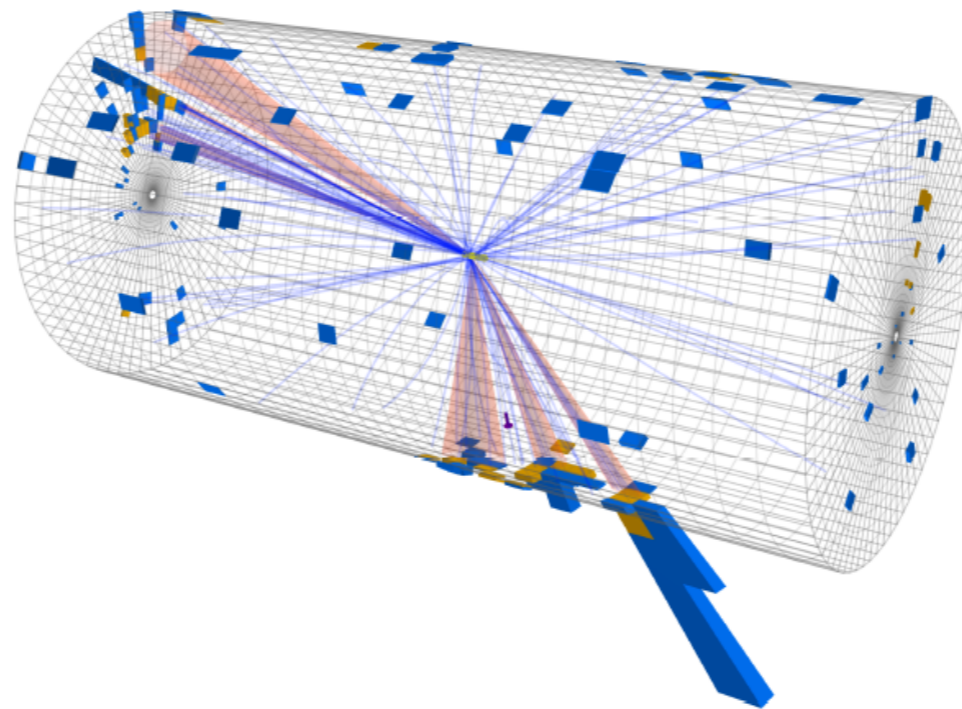

Giorgos Anagnostou,
Institute Of Nuclear & Particle Physics

Outline

- Why do we think that there is dark matter
- How to search it (indirect, direct, mainly colliders)
- How this is done @ the LHC
- A new method to search for dark matter at the LHC

Why search in final states with missing energy @ the LHC?

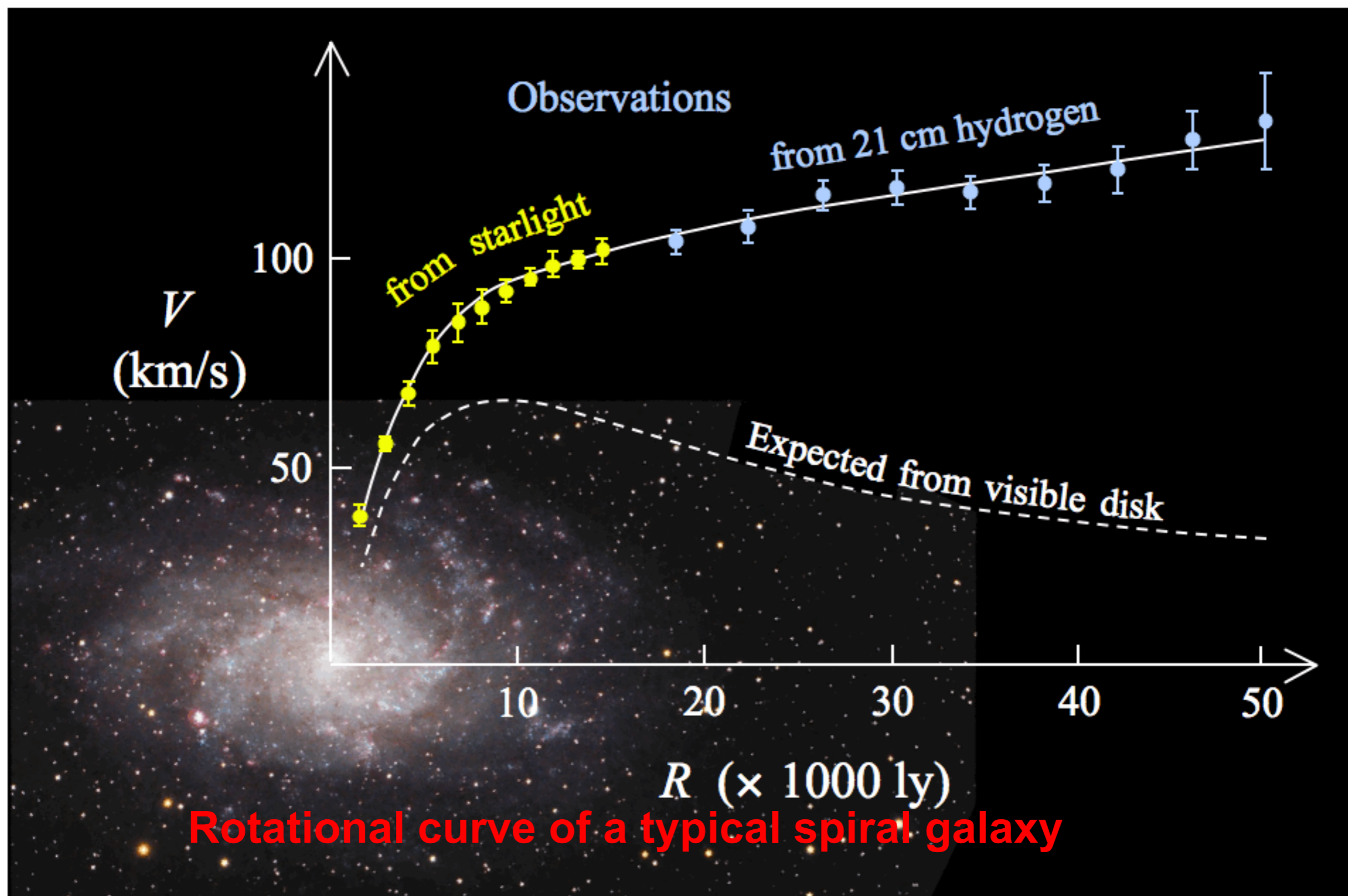

Can we perform a bump hunting for dark matter @LHC?

Instead perform bump hunting by reconstructing events with 2 invisible particles

Anagnostou, G. Searching in 2-Dimensional mass space for final states with 2 invisible particles. J. High Energ. Phys. 2021, 112 (2021)

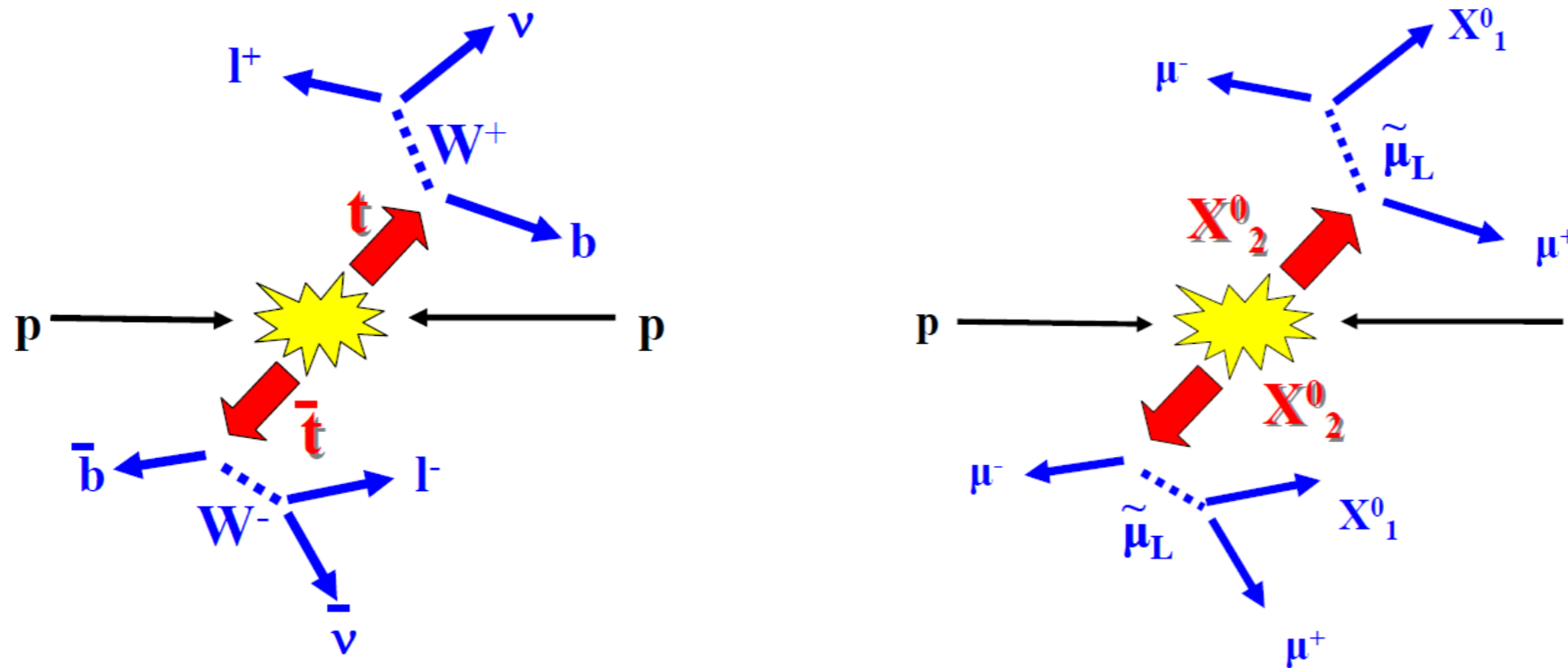

Proof of principle dilepton top pairs (left), as they have very similar topology with dark matter searches with two invisible particles (right).

How can we search for dark matter @ the LHC?

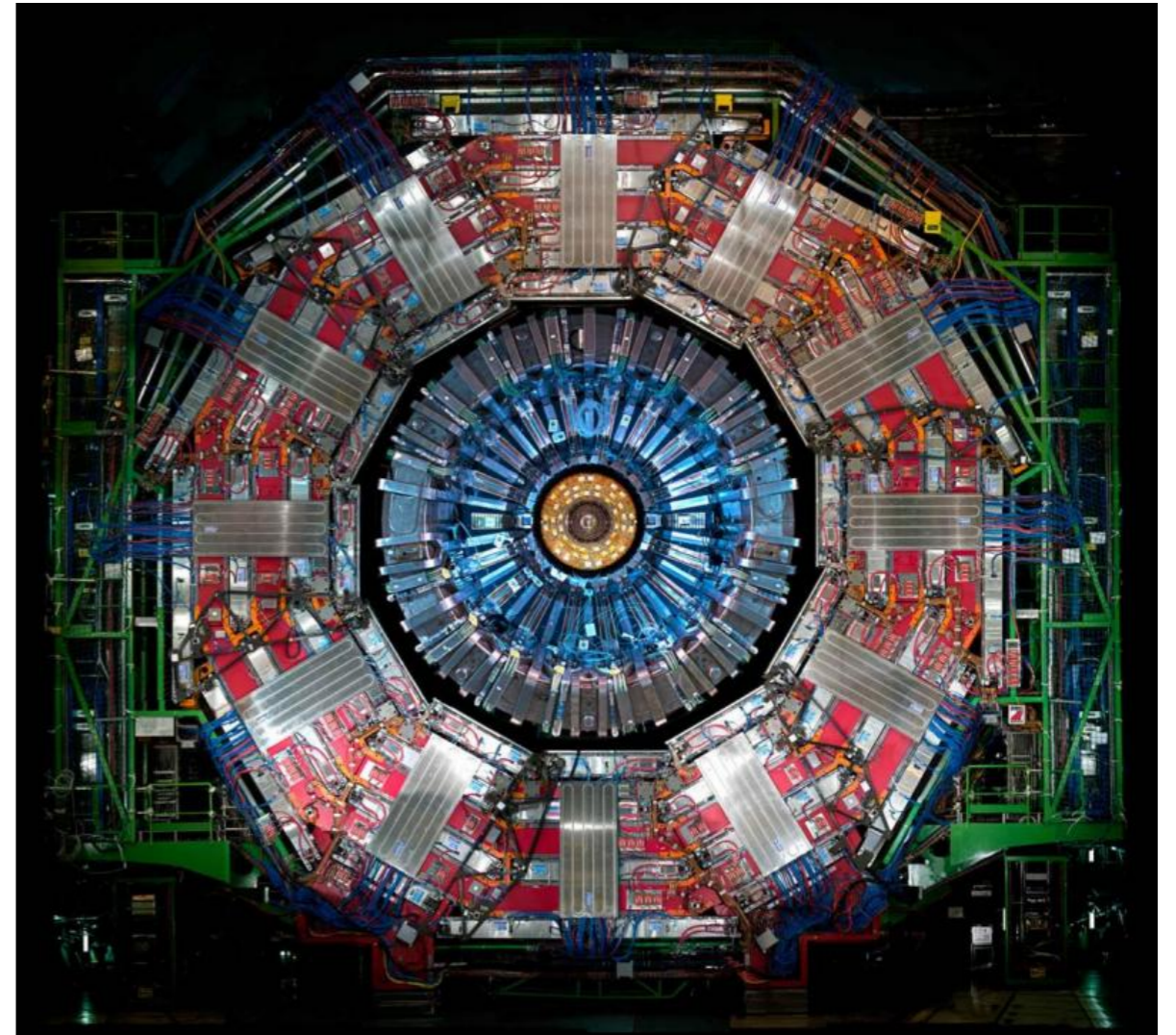

What is the signature of possible DM particles @ LHC?

How to search for dark matter @ the LHC?

Higgs discovery “easy”: mass peaks at predicted region:

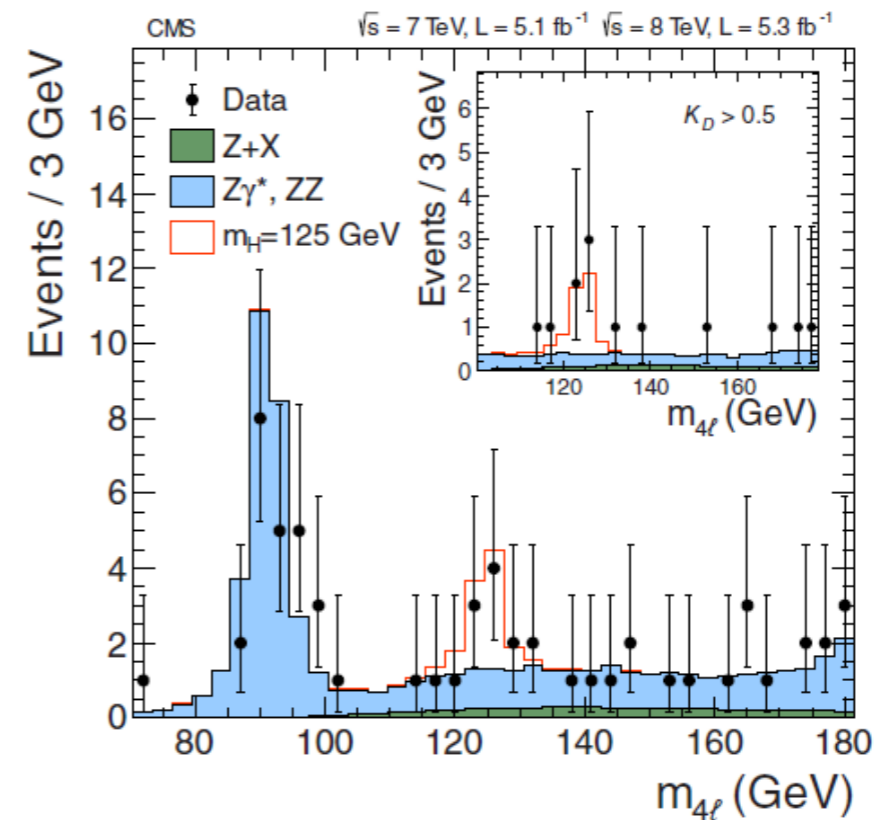
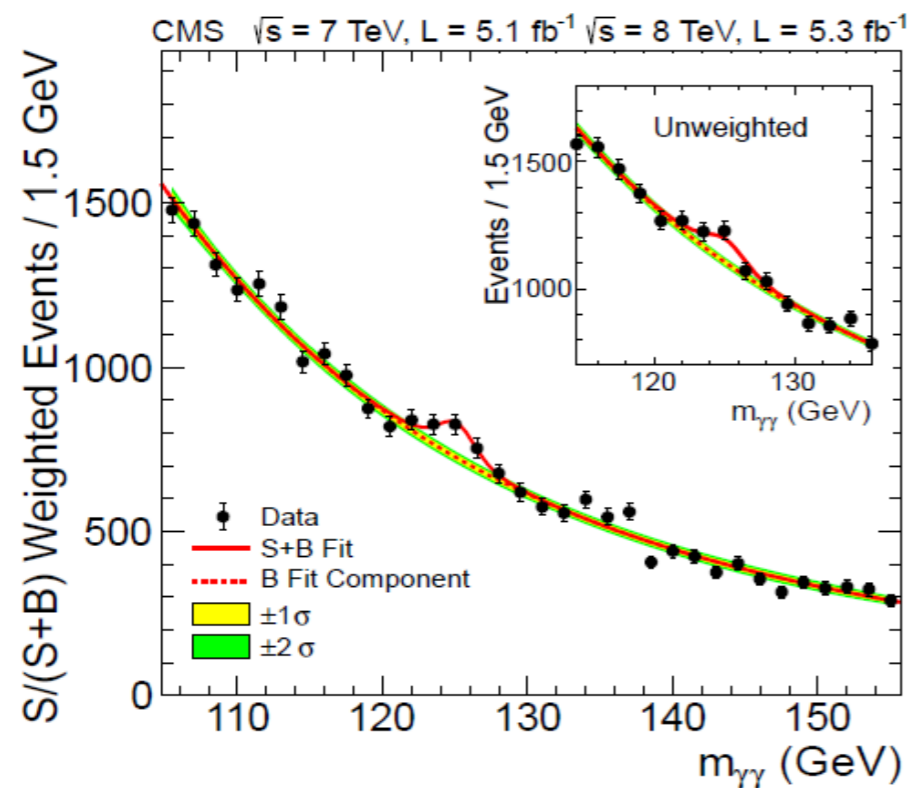

Many models with dark matter particles (e.g. susy) have **at least 2 invisible (undetectable) particles**



use missing energy – like observables.

How to search for dark matter @ the LHC?

Discovery with missing energy difficult to be established (tail of a rapidly falling distribution).

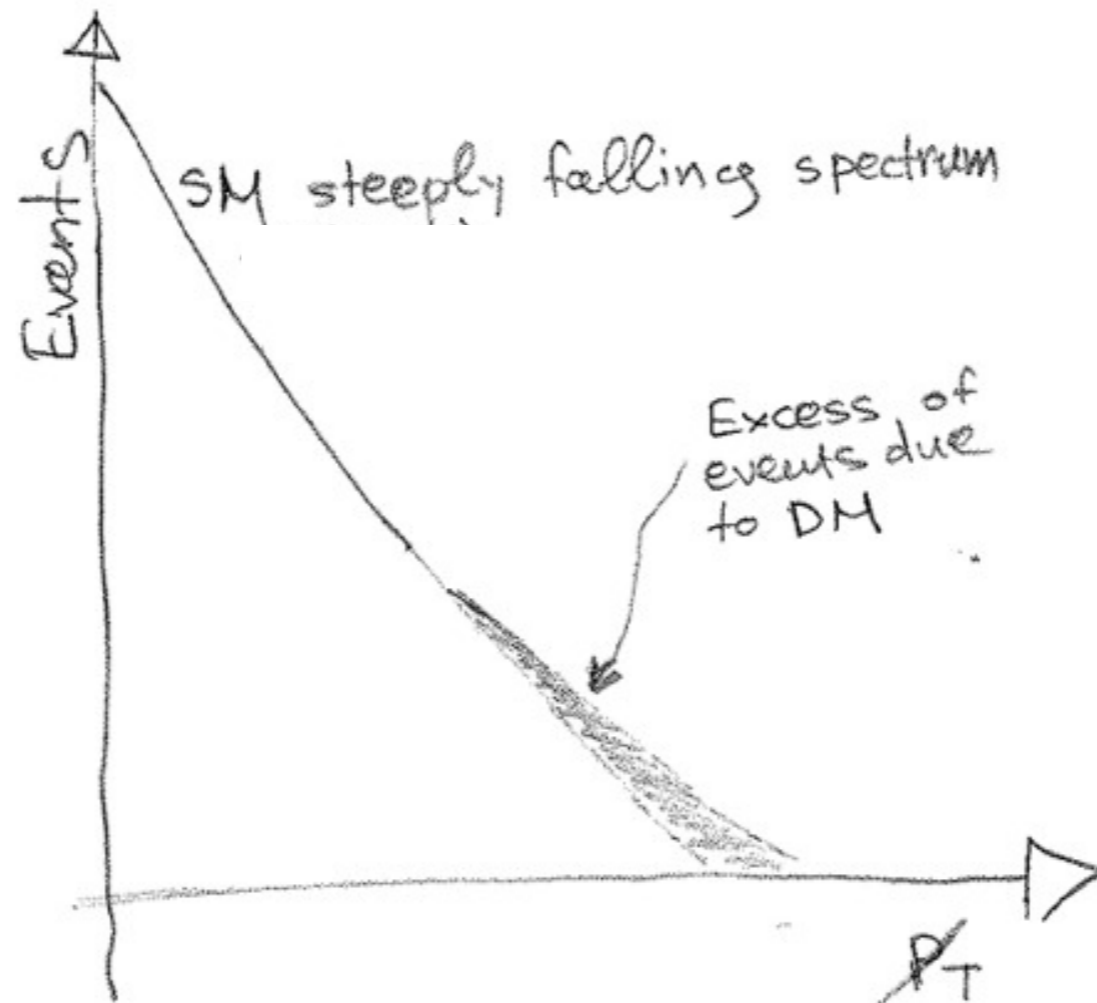

Even if established what can we say about the model?

Is there an optimum parameter space? 1-Dimension

Let's assume a model with 1 New Particle X decaying to visible particles
The experimental observables would be M_X, Γ_X, σ_X

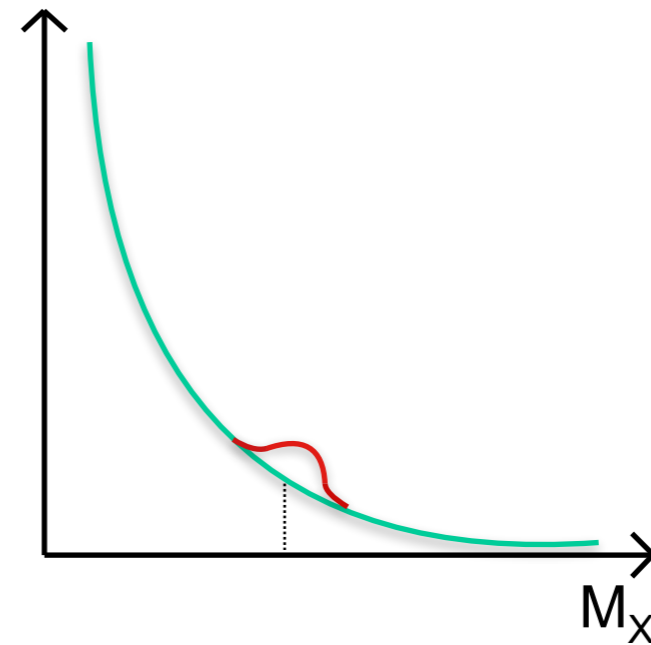
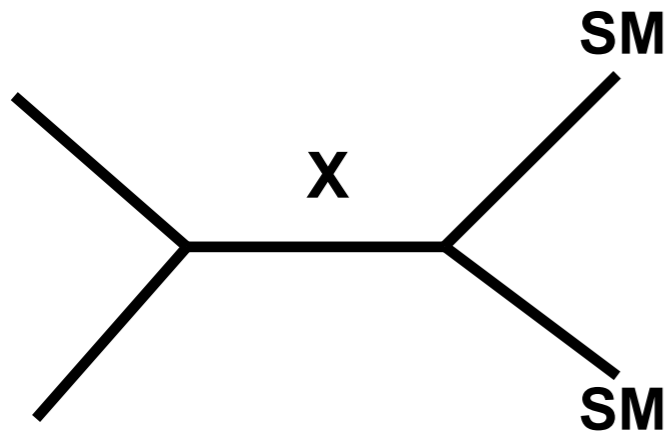

What about Signal to Background ratio? Particle X is concentrated around M_X

As SM has no such particle, the background has no reason to prefer M_X region.
It is actually a decreasing function $f(M_X) \rightarrow 0$ for higher M_X .

S/B is maximized around M_X . The M_X is the optimum single observable to search X

2-Dimensional Mass Space

Model with 2 New Particles X, Y.

The experimental observables would be $M_X, \Gamma_X, \sigma_X, M_Y, \Gamma_Y, \sigma_Y$.

Signal is concentrated in 2-Dimensional mass space around (M_X, M_Y) point.

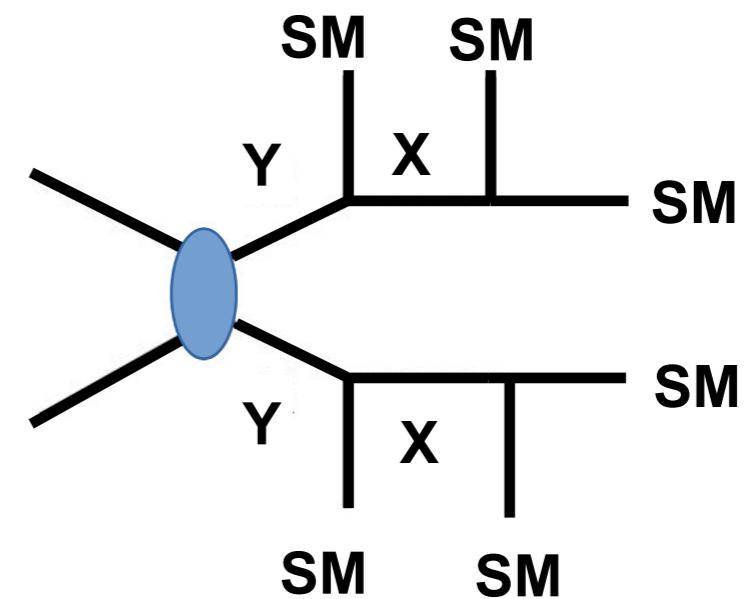
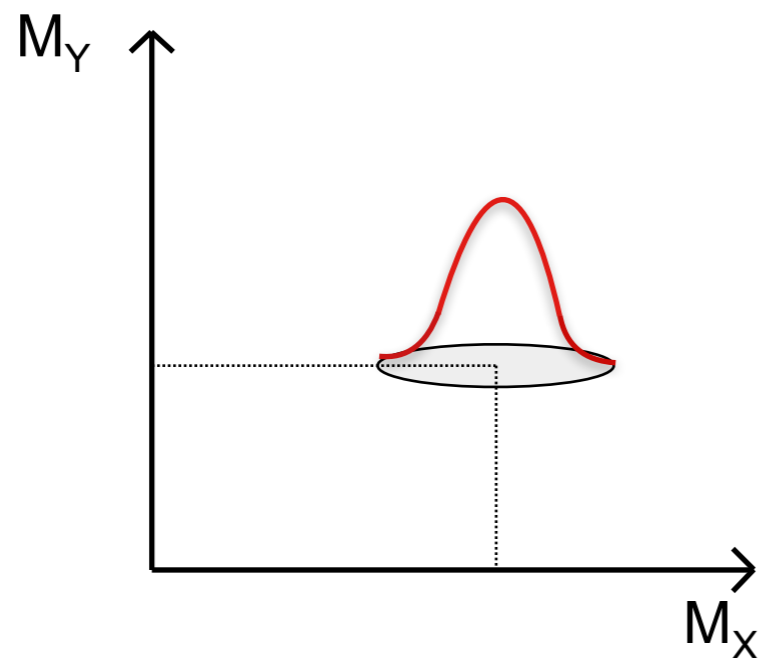

As SM has no X,Y resonances, the background has no reason to prefer the same region.

S/B is maximized around (M_X, M_Y) point.

What about invisible particles?

What if we have in the end of each decay chain an invisible particle (N)?
What can we do?

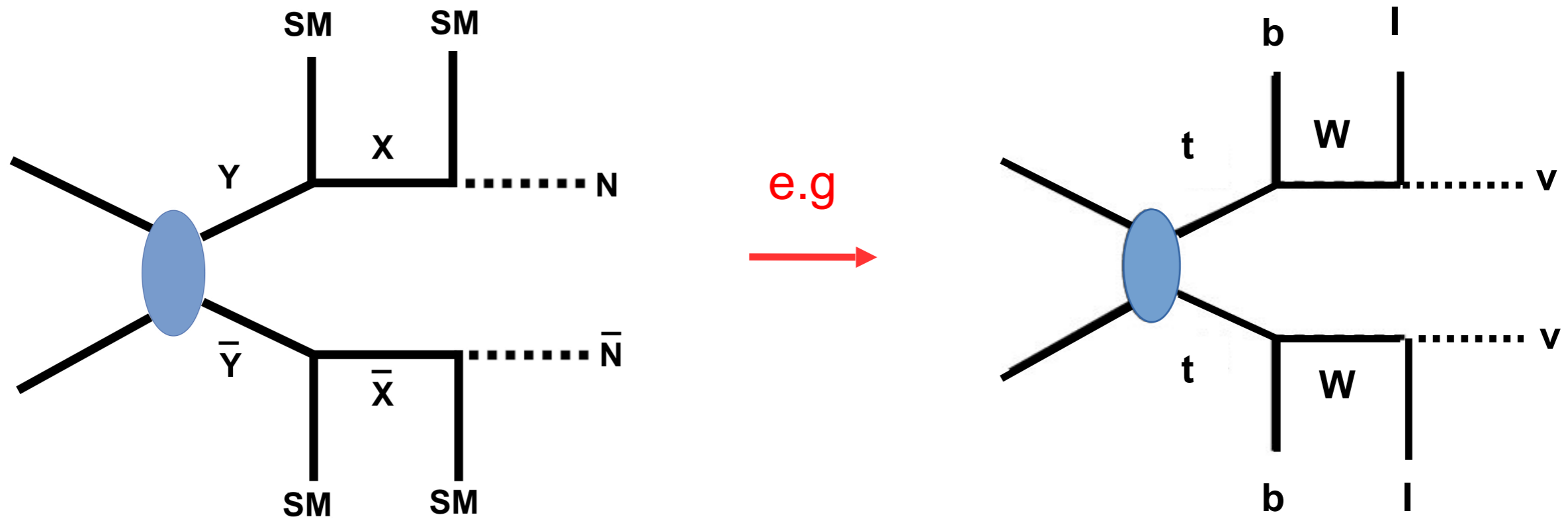

2-D mass reconstruction for final state with 2 invisible particles - What is it? [[hep-ph/2009.10032](https://arxiv.org/abs/hep-ph/2009.10032)]

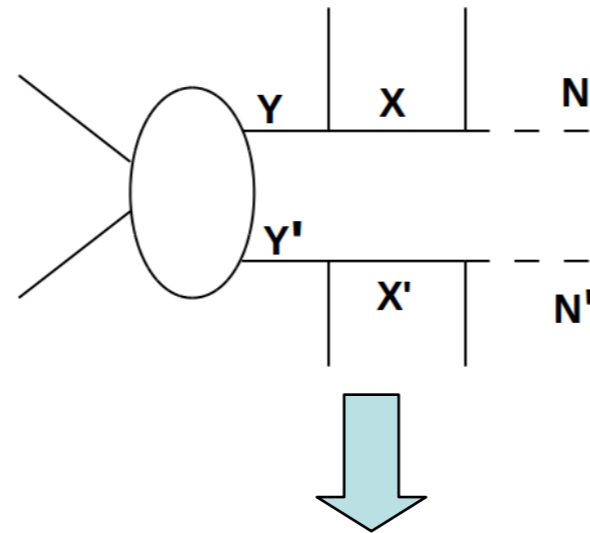

Topology

MET+
Visible particles
momenta

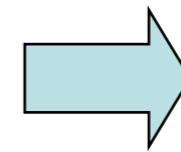
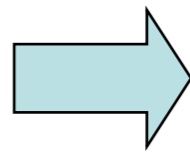

2 unknown masses
 M_X & M_Y per event

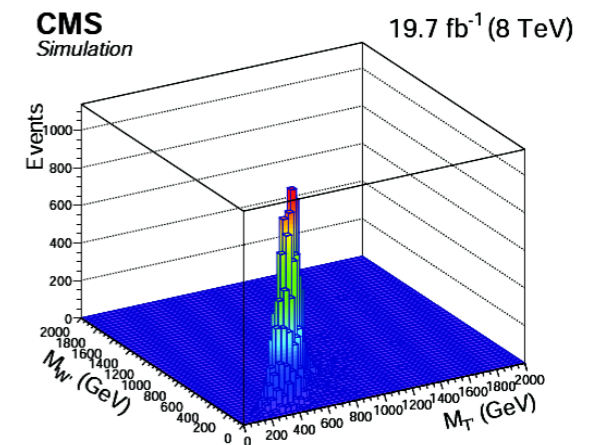

- Needs the solvable topology
- 2 invisible particles

Can we perform a bump hunting for dark matter @LHC?

Already applied in a [CMS search for heavy top partners](#) in Run1, search for ttH in Run2 and 2 [PhD thesis](#).

Possible other applications:

- Search for heavy top partner
- Dark matter @ LHC
- Dihiggs physics

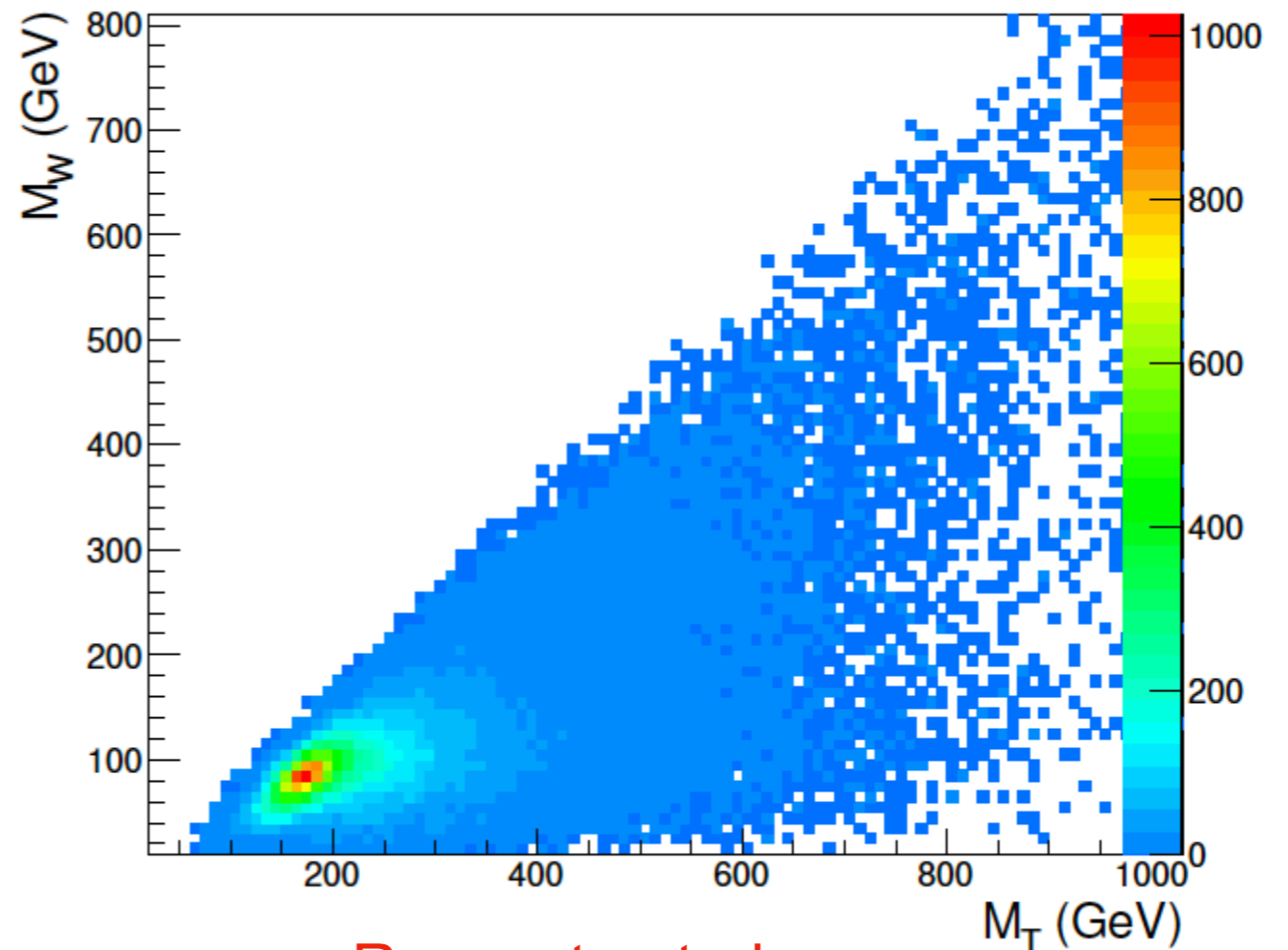

Reconstructed masses
of both top quark and W boson

Search for stop quark pairs

Massive invisible particles

Analytical solution **still works**:
given the masses for stop, charging and neutrino one gets the correct sneutrino momenta

But the extra mass makes system **under-constrained**.

Apply 2-D mass reconstruction method assuming $M_{\tilde{\nu}}=0$
(this is also the way out in e.g MT2)

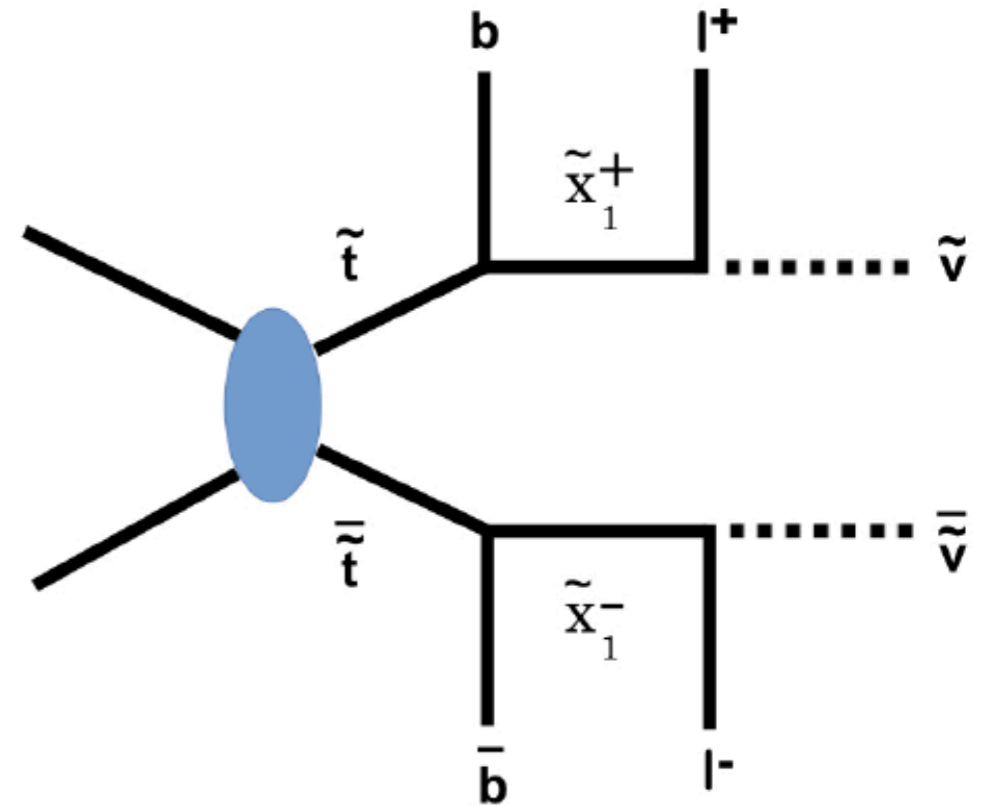

Search for stop quark pairs: 2D mass reconstruction

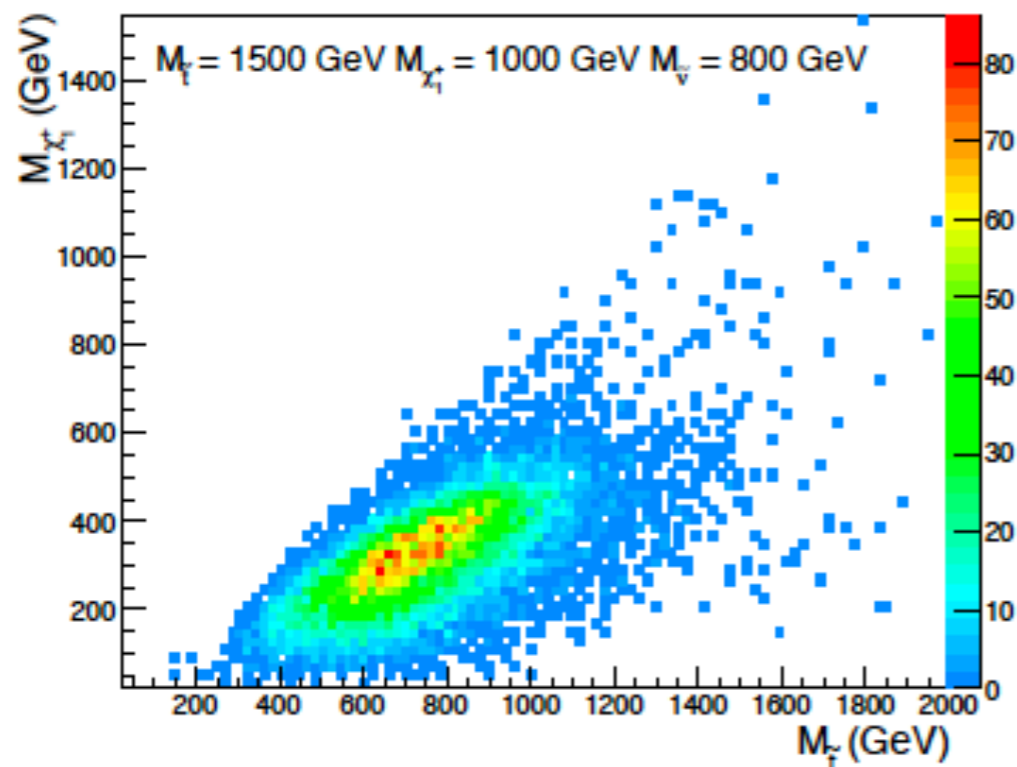

signal for $M_{\tilde{\nu}} = 0$

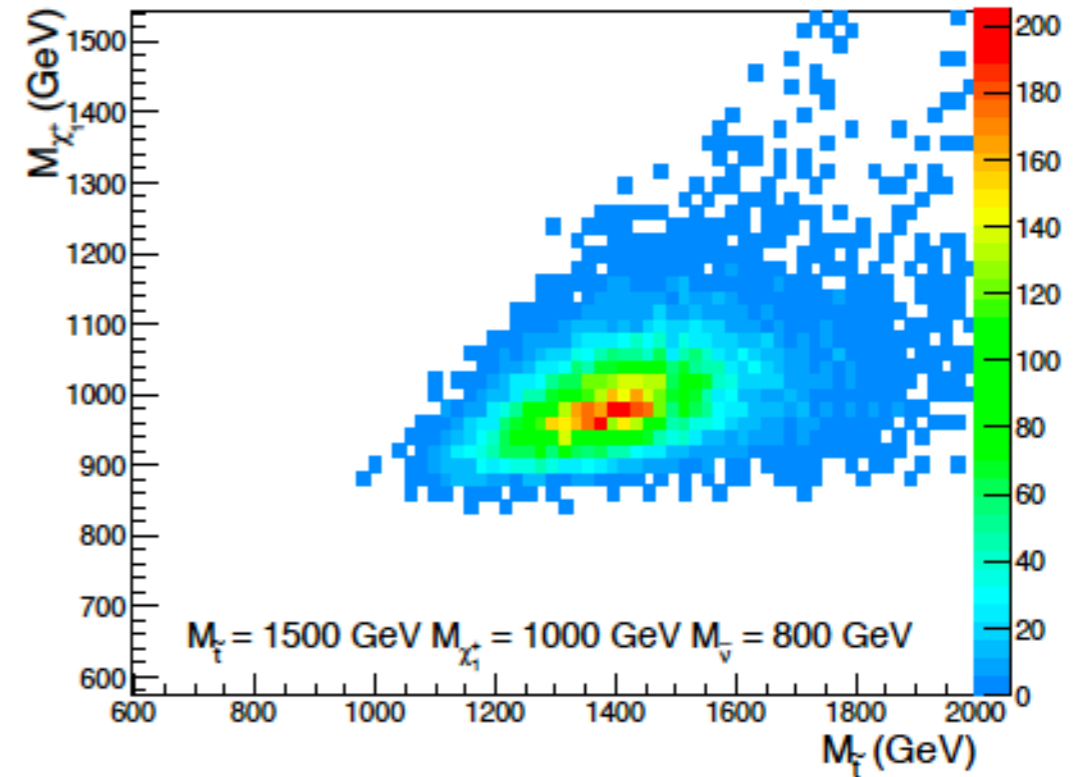

signal for $M_{\tilde{\nu}} = \text{true}$

Still a 2-D bump with a single entry per event!

Masses displaced to lower values

2 Masses (stop & chargino) reconstructed in the true region given the 3rd mass ($M_{\tilde{\nu}}$)

Search for stop quark pairs: bump hunting

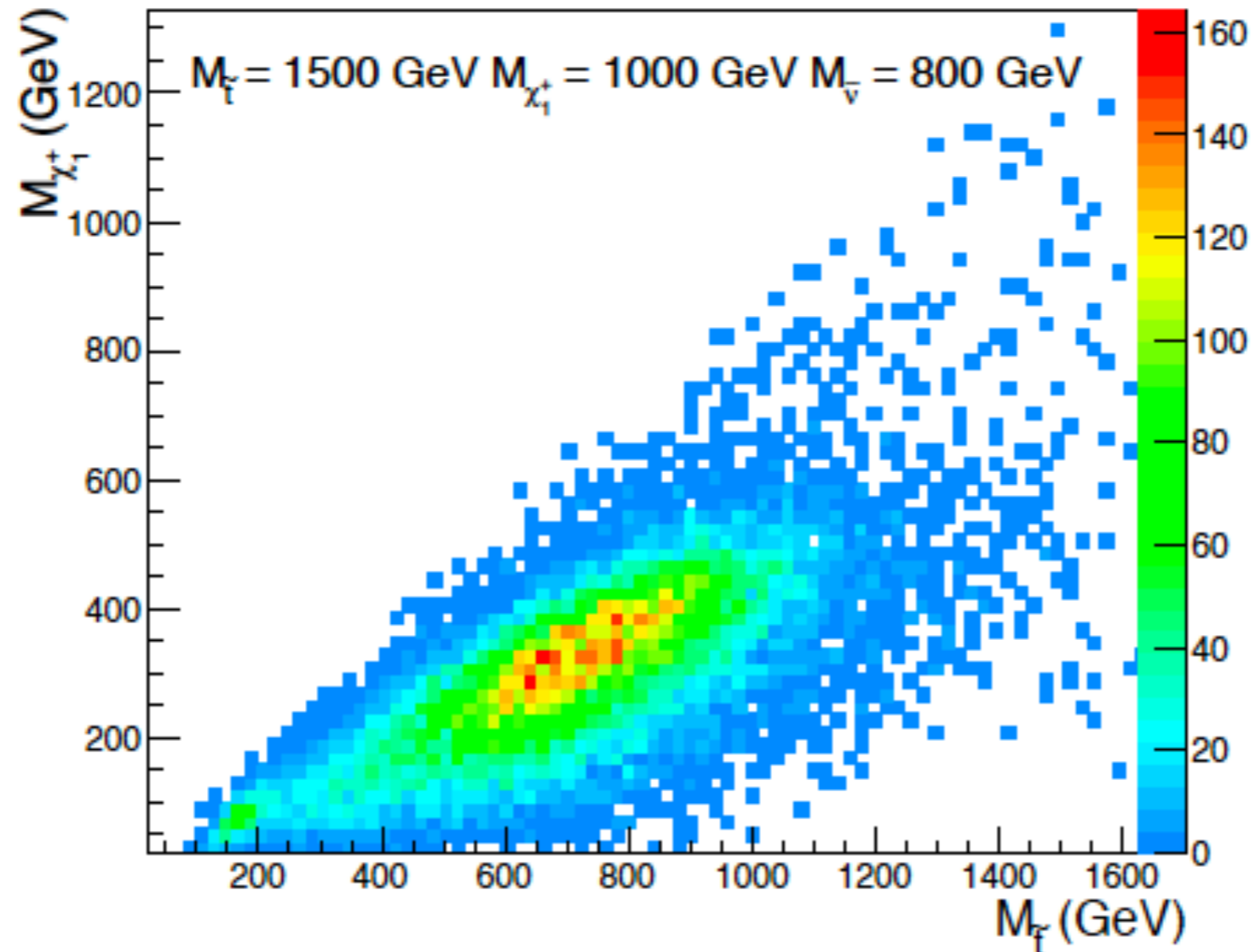

signal (stop pairs)+ SM background (top pairs)

Search can be a bump hunting with a single entry per event

Back-up

How to search for dark matter?

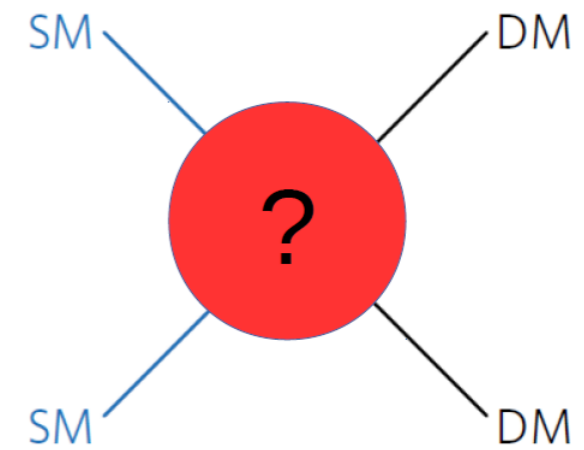
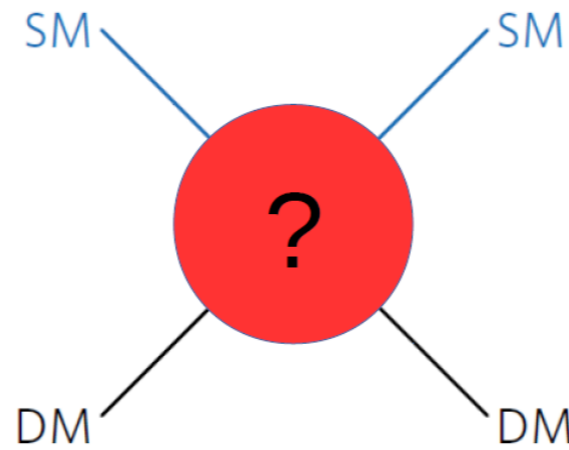
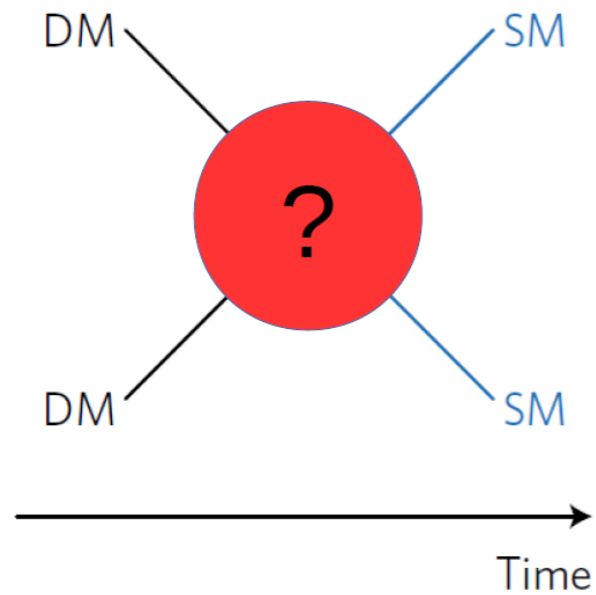

Indirect searches,
annihilation of DM into SM



Direct searches,
DM scattering from SM



Collider searches,
SM collisions to DM

WIMP miracle

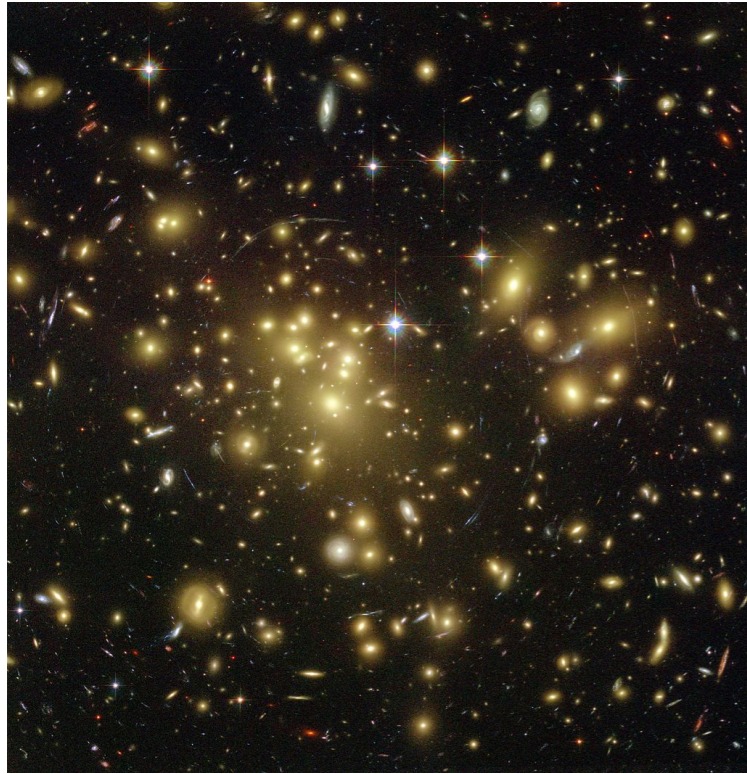

Gravitational lensing

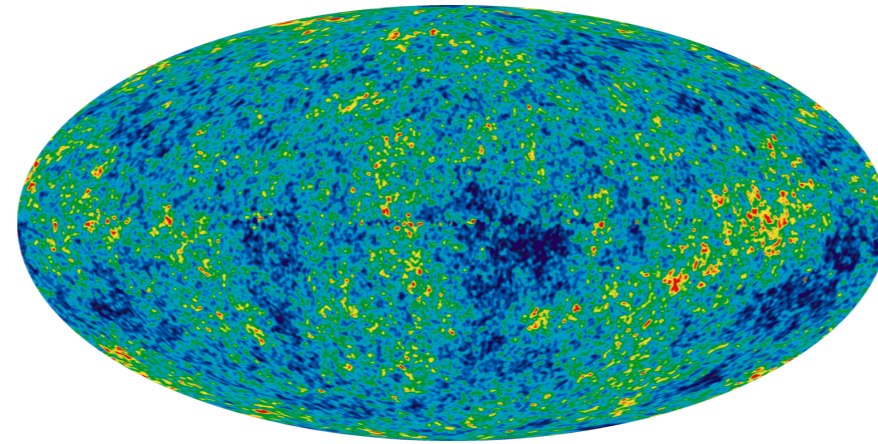

Cosmic Microwave Background

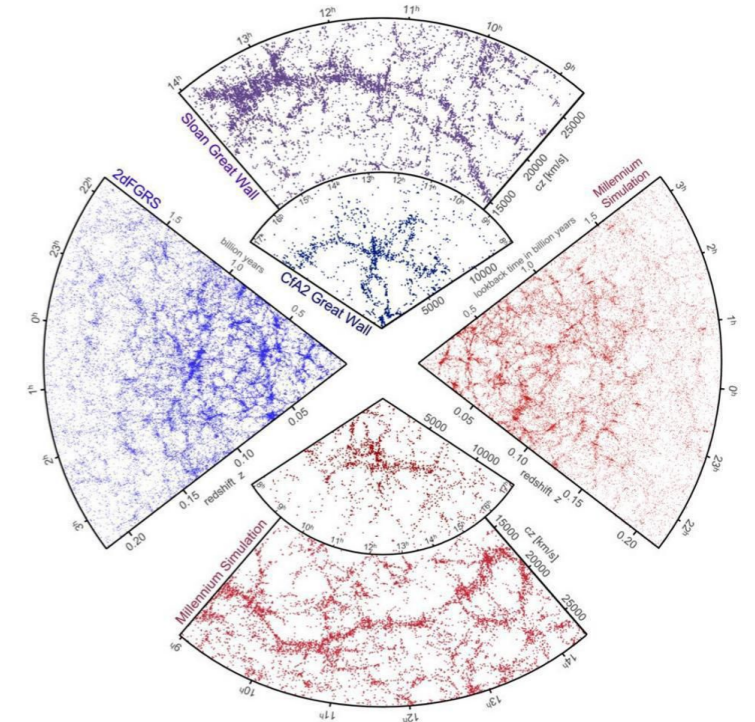

Large structure formation

if the DM mass is around the weak scale (similar to the massive particles found in the SM) and if DM particles couple with SM particles with a strength similar to that of the SM electroweak interactions, this simple scenario approximately predicts the correct observed DM relic abundance – WIMP miracle !!

Weakly Interacting Massive Particles @ the LHC reach !

Why search in final states with 2 invisible particles @ the LHC?

Optical images from the Magellan telescope with overplotted contours of spatial distribution of mass, from gravitational lensing

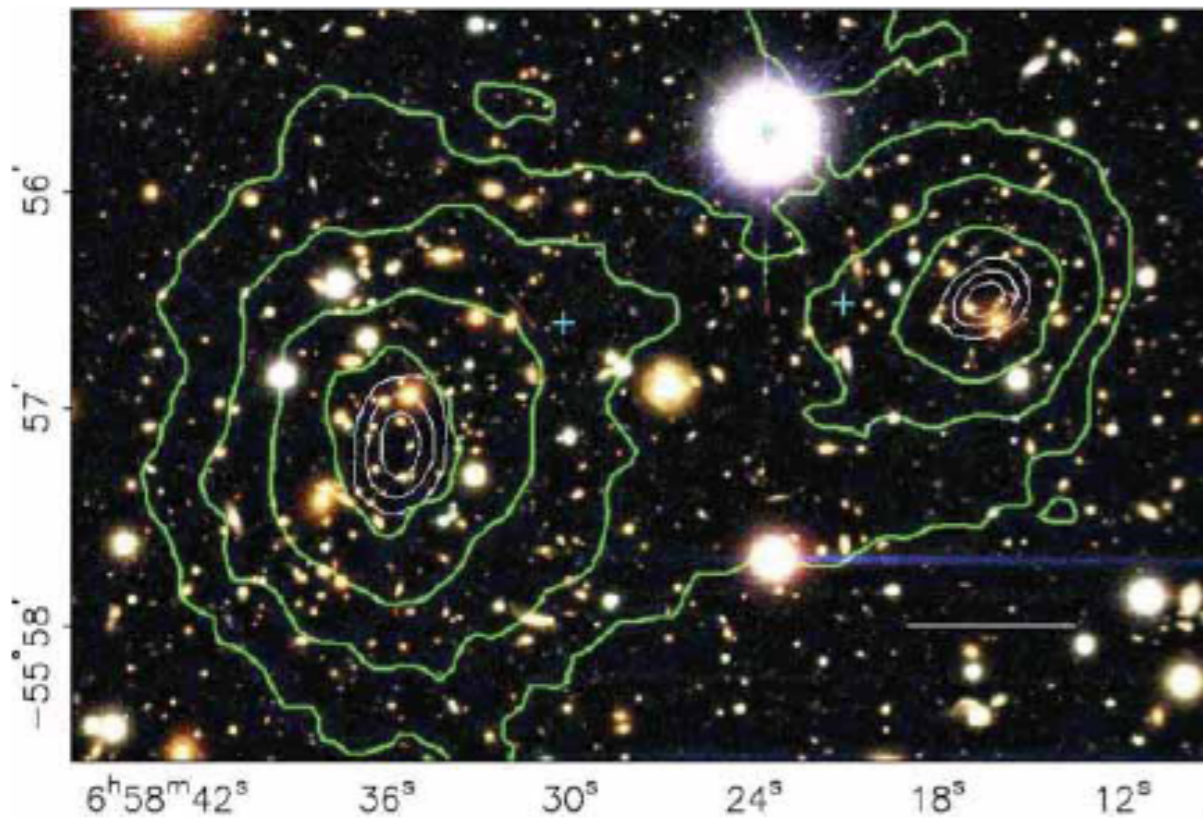

Bullet cluster - Magellan

The same contours overplotted over Chandra x-ray data that traces hot plasma in a galaxy.

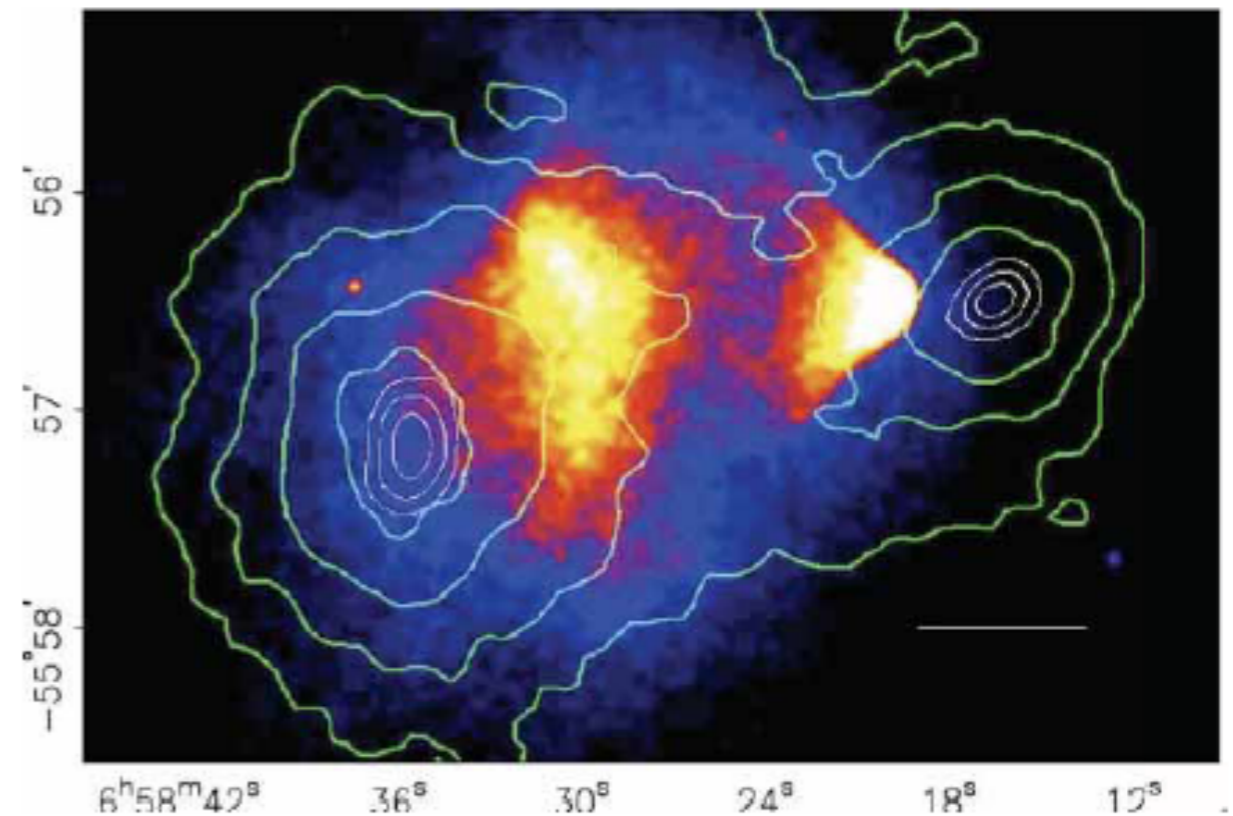

X-ray from Chandra telescope

- most of the matter resides in a location different from the plasma
- plasma underwent frictional interactions during the merger and slowed down