

# ISOLDE @ CERN

Anastasios Lagoyannis  
Tandem Accelerator Laboratory  
Institute of Nuclear and Particle Physics  
N.C.S.R. “Demokritos”

# Why RIB's ?

## Chart of Nuclei

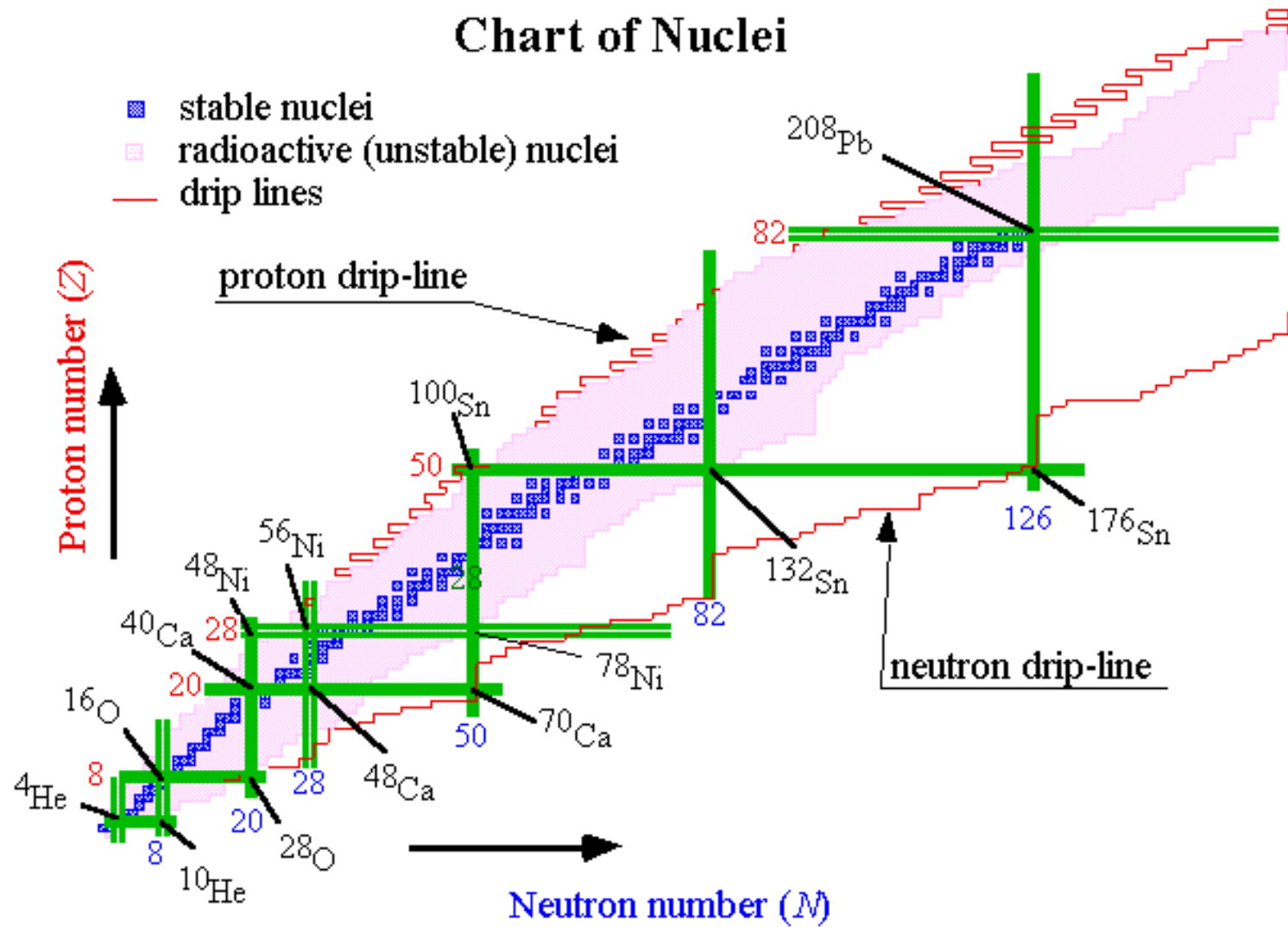

# Production of RIB

## Projectile Fragmentation

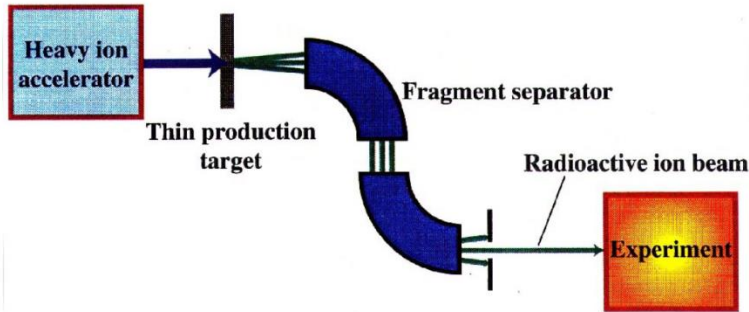

- Time limit  $\sim 1 \mu\text{s}$
- High luminosity
- High energy beam  $>100 \text{ MeV/u}$
- No chemistry

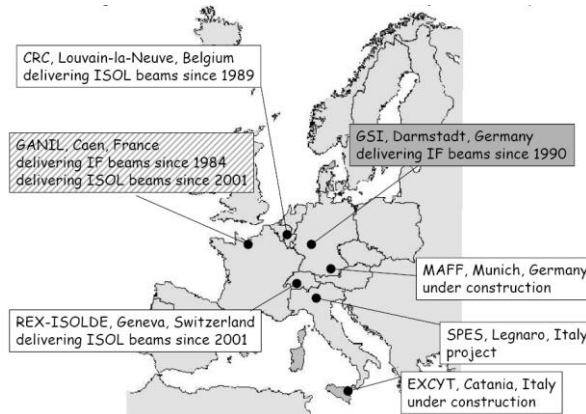

## ISOL

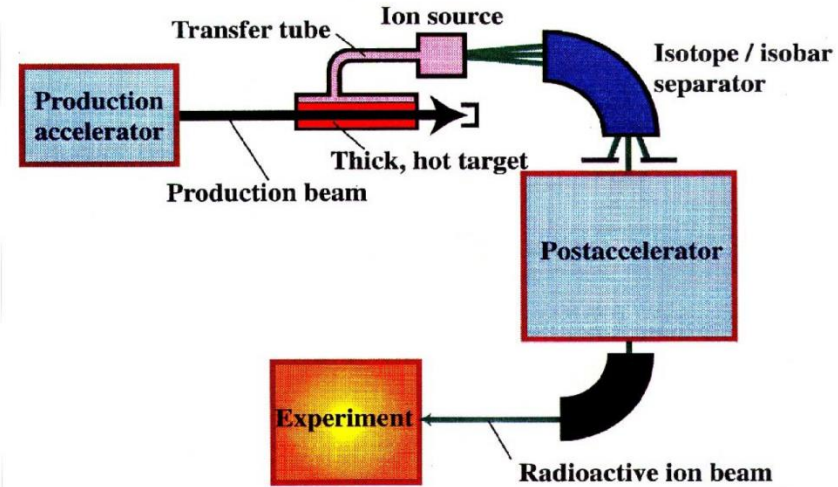

- Time limit  $\sim 10\text{-}100 \text{ ms}$
- High beam intensity close to stability
- Better beam quality (purity, optics ...)
- Nuclei produced at rest



# CERN

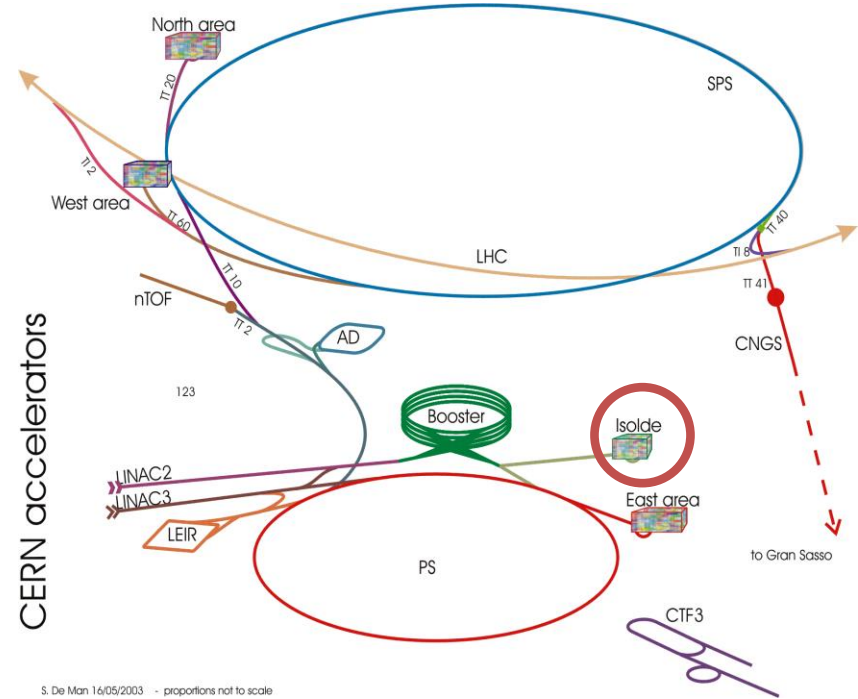



# ISOLDE

## Resonance Ionization Laser Ion Source

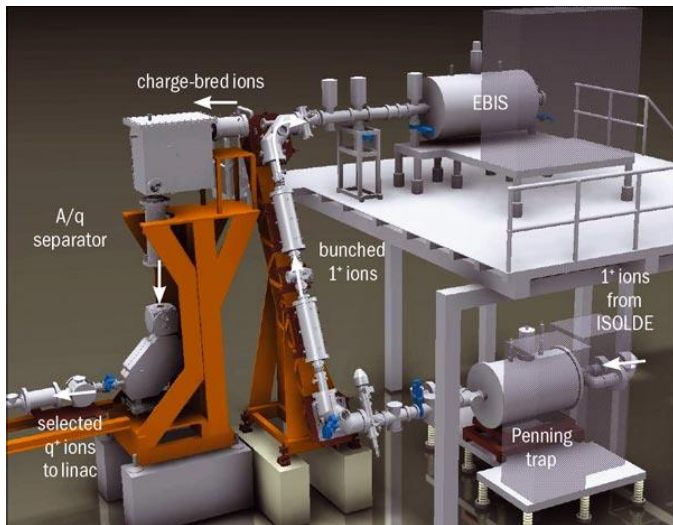
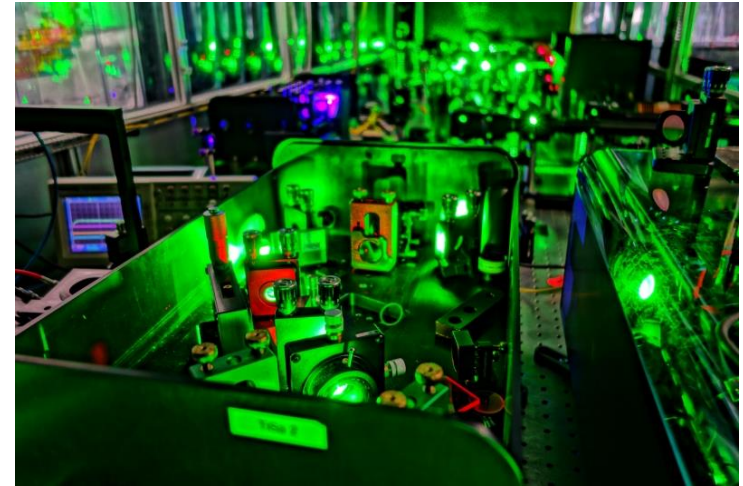
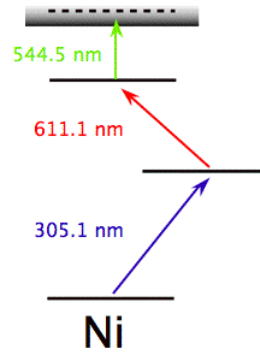
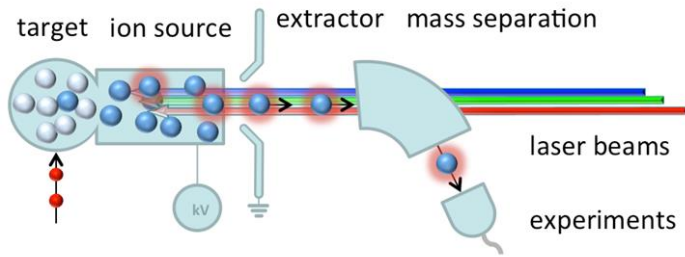

**REXTRAP**

Penning trap, slowing down ions, accumulation and bunching

**REXEBIS**

Electron Beam Ion Source  
Charge breeding

**Mass separator**

$A/q < 4.5$





# Yields

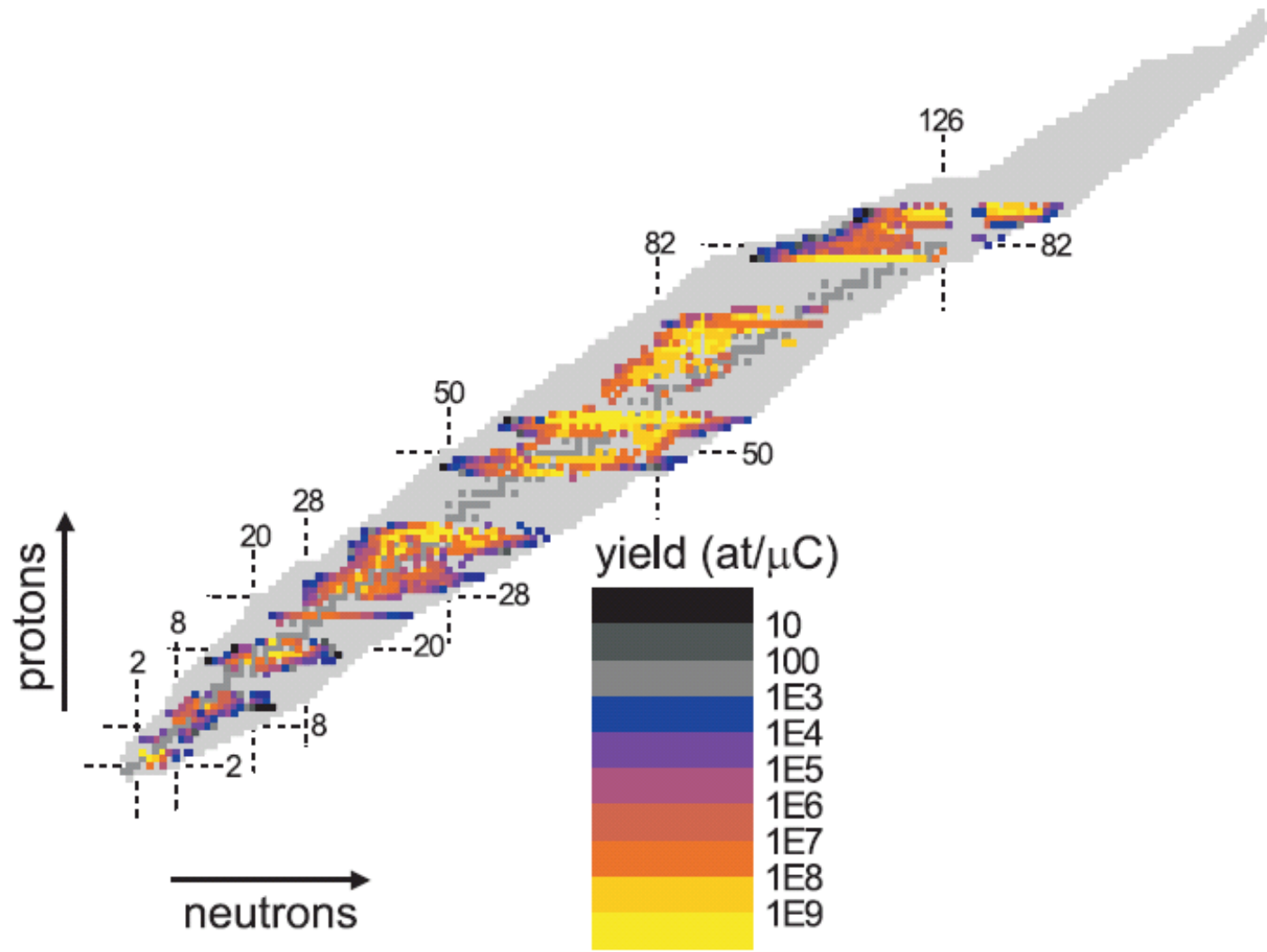

# Physics case: $^{68}\text{Ni}$

## Is the nature of the N=40 subshell closure understood?

- First excited state  $0^+$  at higher energies
- The  $2^+$  state at larger excitation energy
- Small  $B(E2, 0^+ \rightarrow 2^+)$
- No irregularity at the  $S_{2n}$  or at the binding energies
- Fragile nature of the N=40 subshell closure
- Other reasons for the small observed  $B(E2, 0^+ \rightarrow 2^+)$

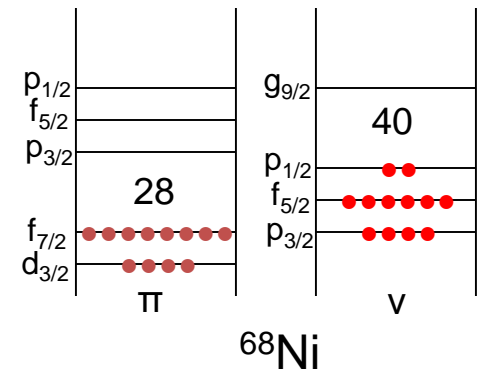
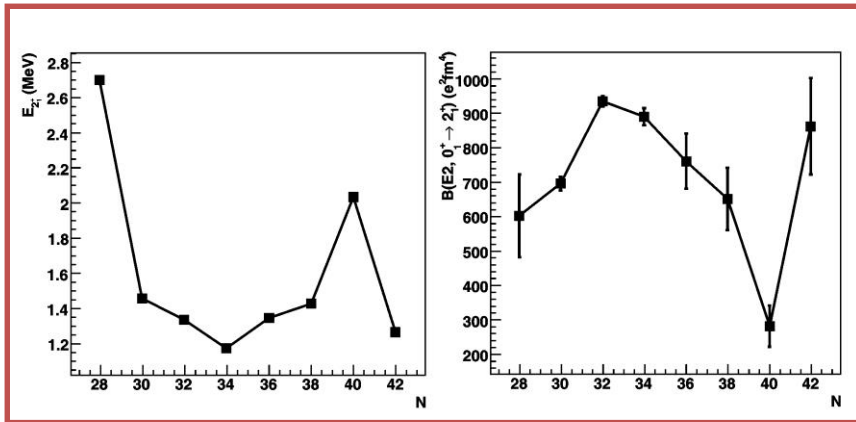
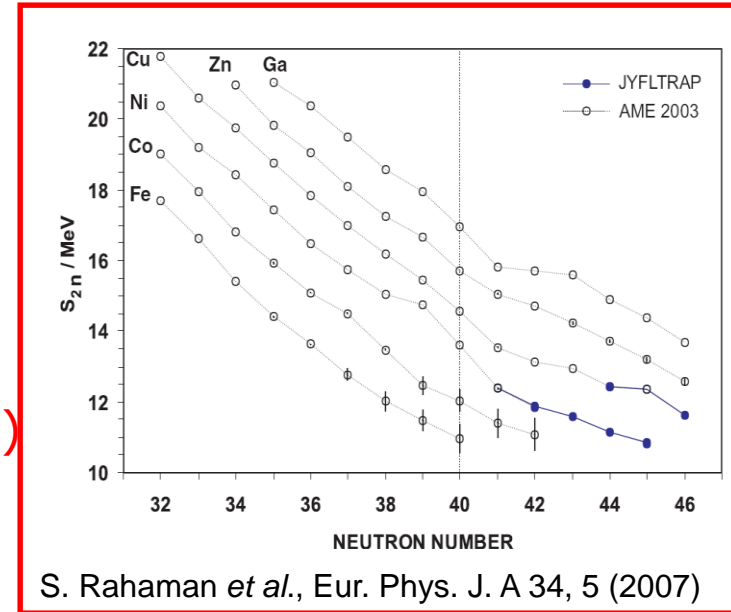



# Physics case: $^{68}\text{Ni}$

## Study of the single particle character of the neutron rich Ni isotopes

Physics case:  $^2\text{H}(^{66}\text{Ni},p)^{67}\text{Ni}$ ,  $Q = 3.583$  MeV

- $^{67}\text{Ni}^9$  one hole state of the  $^{68}\text{Ni}$
- g factor exp. value smaller by a factor of 2 than the expected for  $1g_{9/2}$
- Unambiguous determination of the spin and parities of the the first excited states - one more state  $v_{3/2}$  not yet observed
- Single particle character of the states of  $^{67}\text{Ni}$  (relative SF's)
- A good starting point as to determine the single particle character of the Ni isotopic chain – single particle systematics

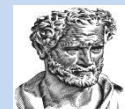
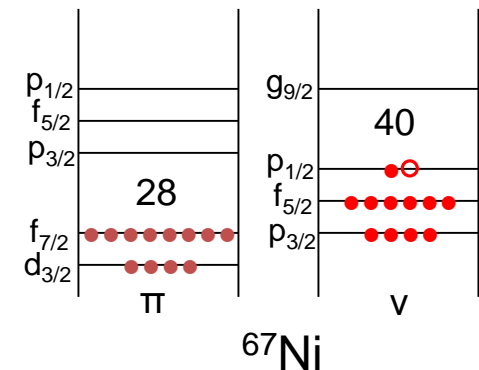
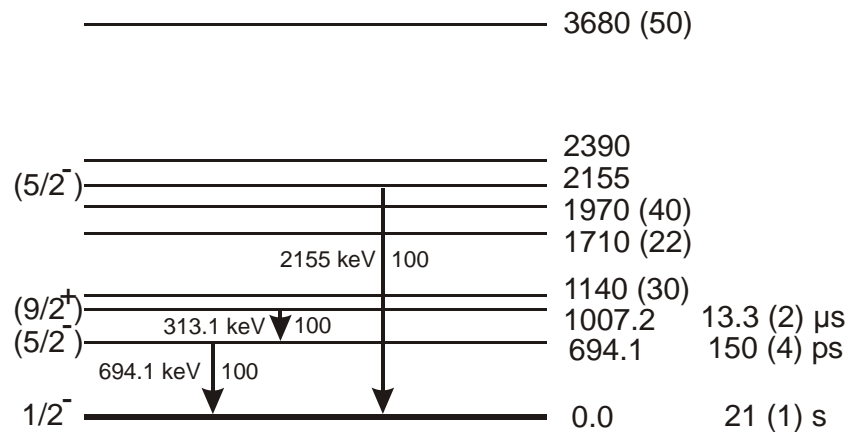

# Experimental Setup

- “Thick”  $\text{CD}_2$  target measurement ( $1\text{ mgr/cm}^2$ )
  - ⊕ Spectroscopic information for the excited states up to 3 MeV.
  - ⊕ Coincidences with  $\gamma$
- “Thin”  $\text{CD}_2$  target measurement ( $100\ \mu\text{gr/cm}^2$ )
  - ⊕ Spectroscopic information for the ground and the second excited state.
  - ⊕ Singles: only backward angles

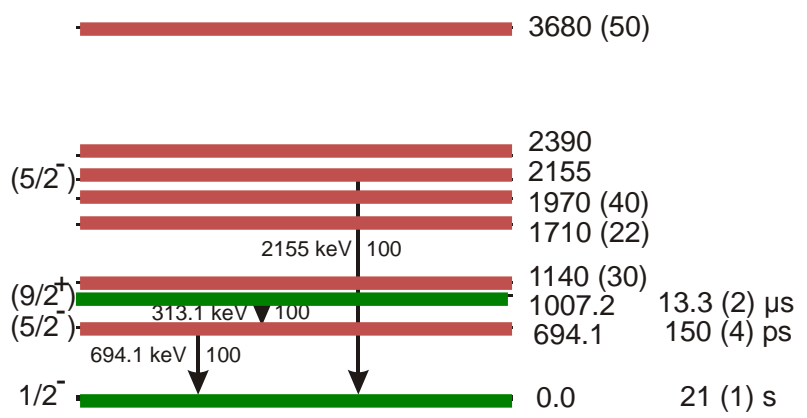
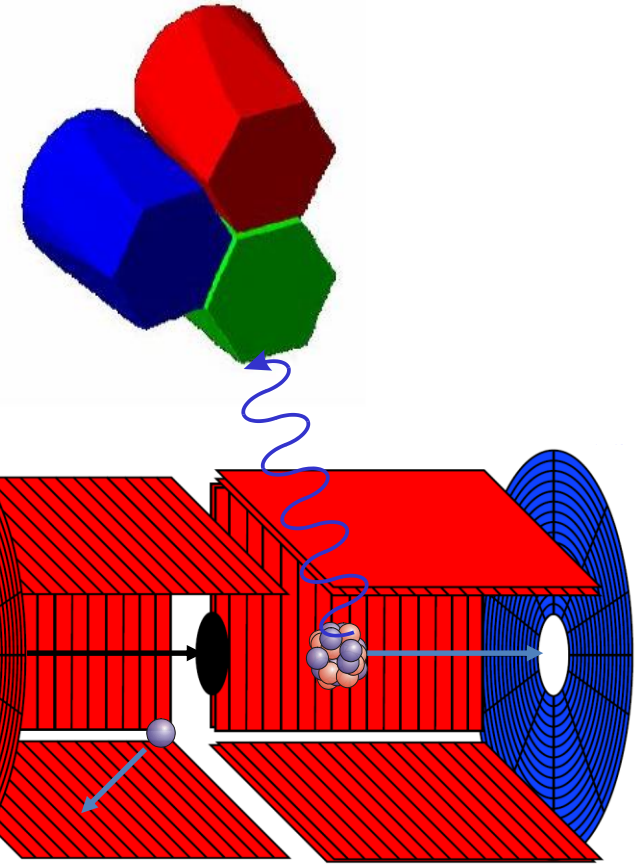

# Miniball

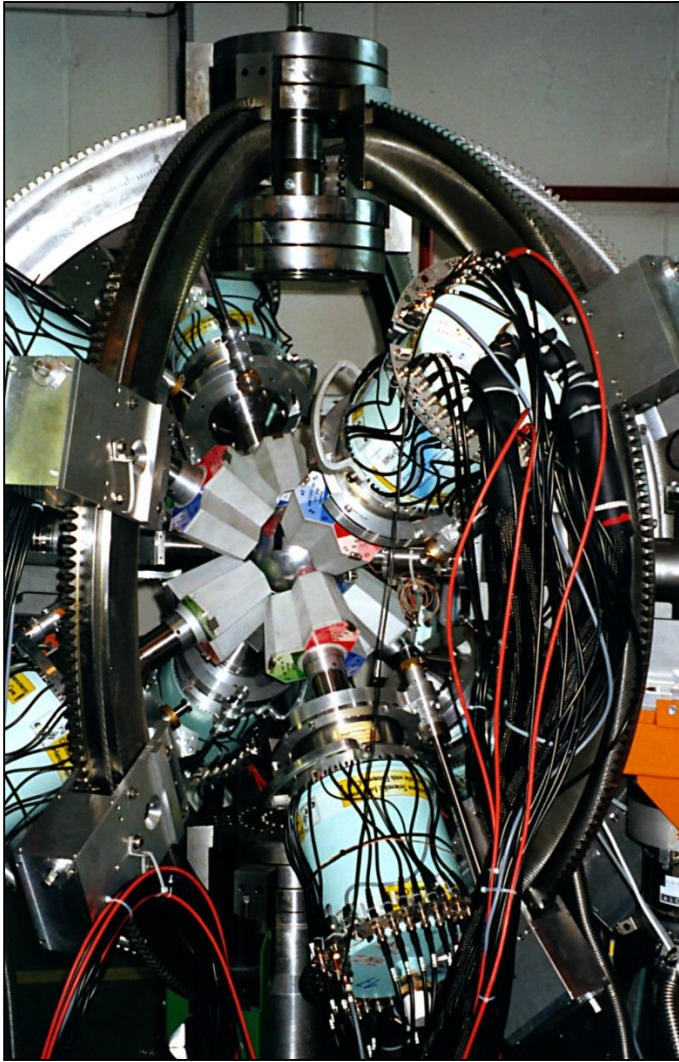

8 x



= 168 channels

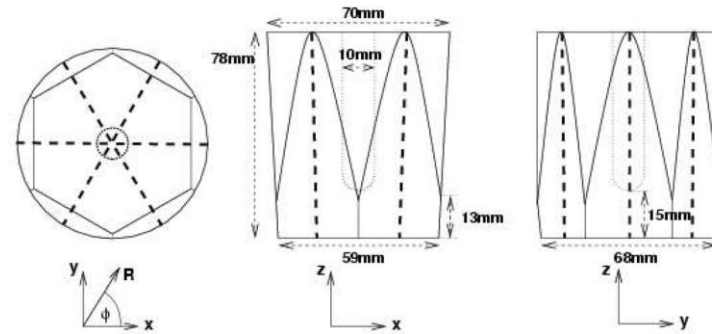

$\epsilon = 10\% @ 1 \text{ MeV}$





# Silicon Barrel

| Detector                    | Angles  | Thickness         | Segmentation                                      |
|-----------------------------|---------|-------------------|---|
| Forw. CD ( $\Delta E$ )     | 8-30    | 300 $\mu\text{m}$ | 16 annular x 24 radial                            |
| Forw. CD (E)                | 8-30    | 1.5 mm            | no  |
| Forw. Barrel ( $\Delta E$ ) | 30-75   | 140 $\mu\text{m}$ | 16 stripes $\perp$ beam + ch. Div resistive layer |
| Forw. Barrel (PAD)          | 30-75   | 1 mm              | no  |
| Back. Barrel                | 104-152 | 500 $\mu\text{m}$ | 16 stripes $\perp$ beam + ch. Div resistive layer |
| Back. CD                    | 152-172 | 500 $\mu\text{m}$ | 16 annular x 24 radial                            |

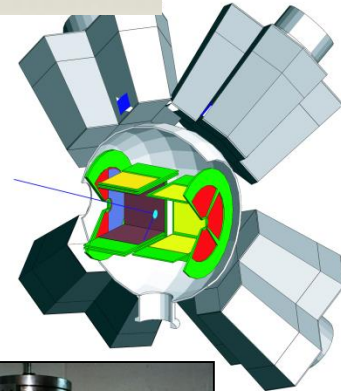
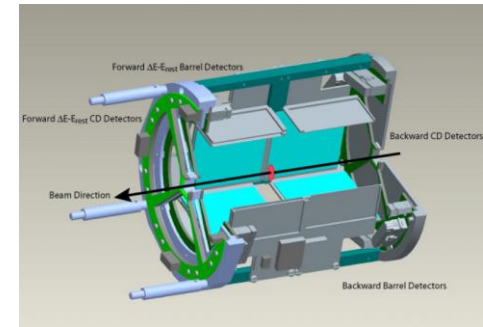

**Particle detector: 464 channels**

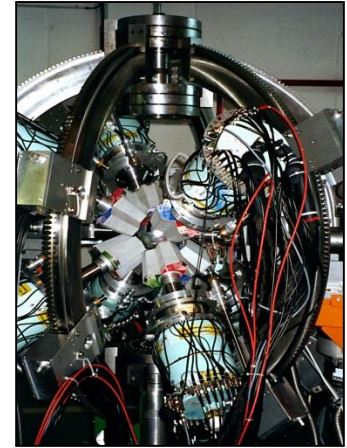
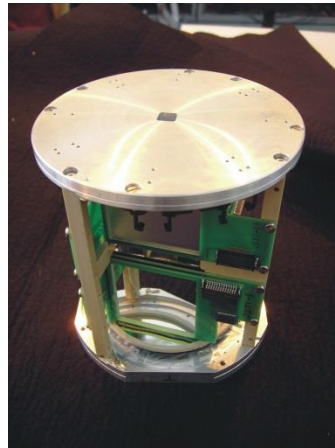
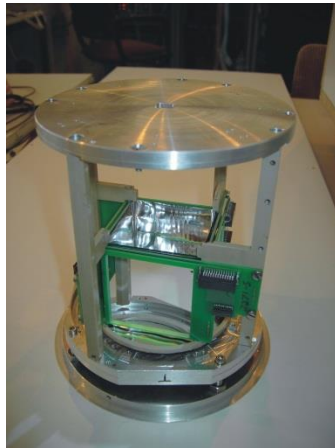

# HIE - ISOLDE

- Intensity
- Energy
  - Coulex for all RIB
  - Transfer reactions
- Efficiency low energy + accelerated
- Selectivity
- Beam “quality”
  - Reduced phase space
  - Bunching
- Polarization .....

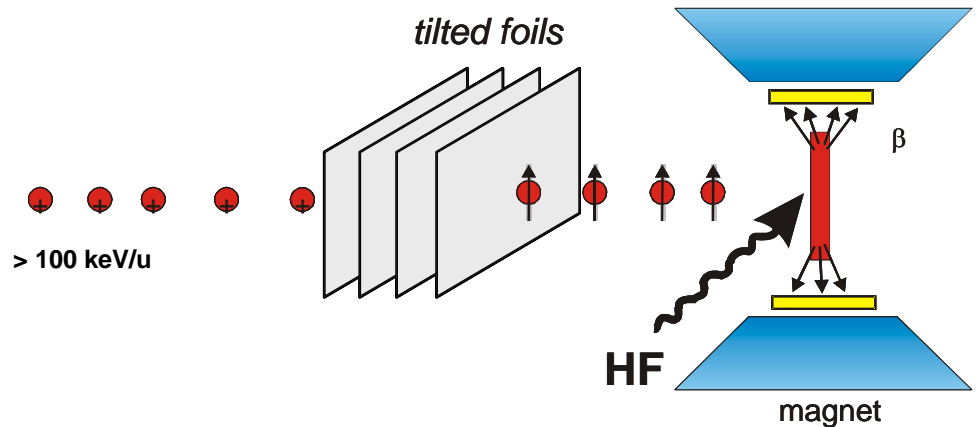
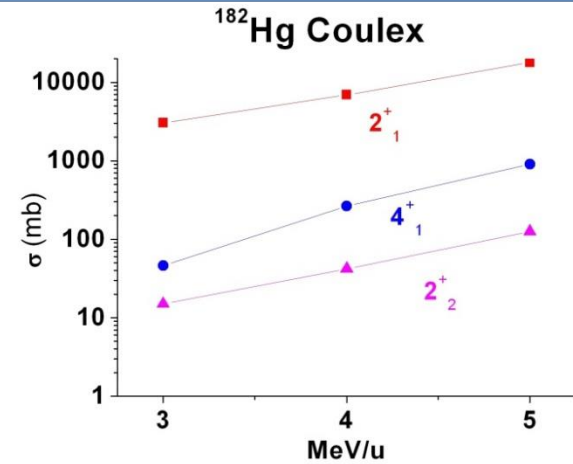



# HIE - ISOLDE

Increase in REX energy from 3 to 10 MeV/u  
(first step an increase to 5.5 MeV/u)

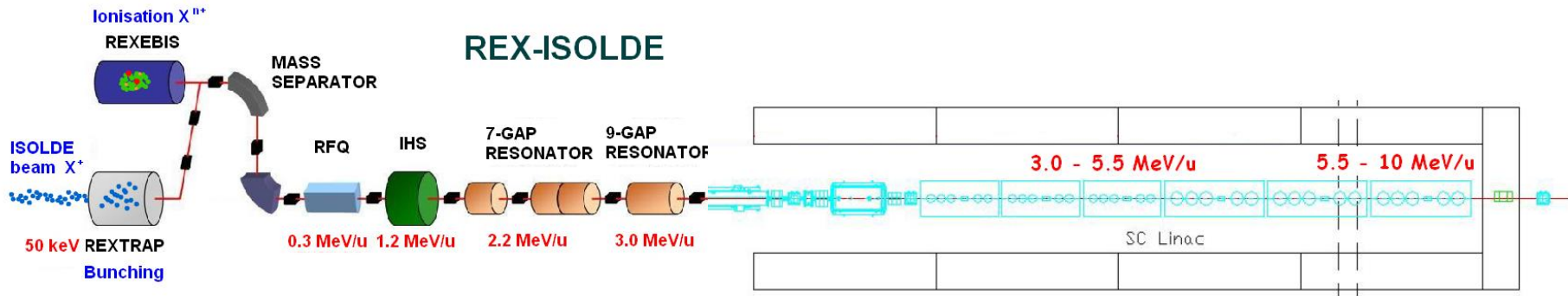

**Increase proton intensity 2 → 6  $\mu$ A (LINAC4, PSB upgrade) - target and front-end upgrade**

RFQ cooler, REX-TRAP, REX-EBIS REX-ECR upgrades

Super-HRS for isobaric separation  
RILIS upgrade & LIST

