

Giovanni Maria Piacentino, G. Di Sciascio, A. Gioiosa, D.S
Hajdukovic, L.Latronico, A. Palladino, G.Tassielli, G. Venanzoni.

Presented by G.M. Piacentino

TeV PARTICLE ASTROPHYSICS

Measuring gravitational effects on antimatter in space

AUGUST 7-11

2011

PPDA

COLUMBUS, OH

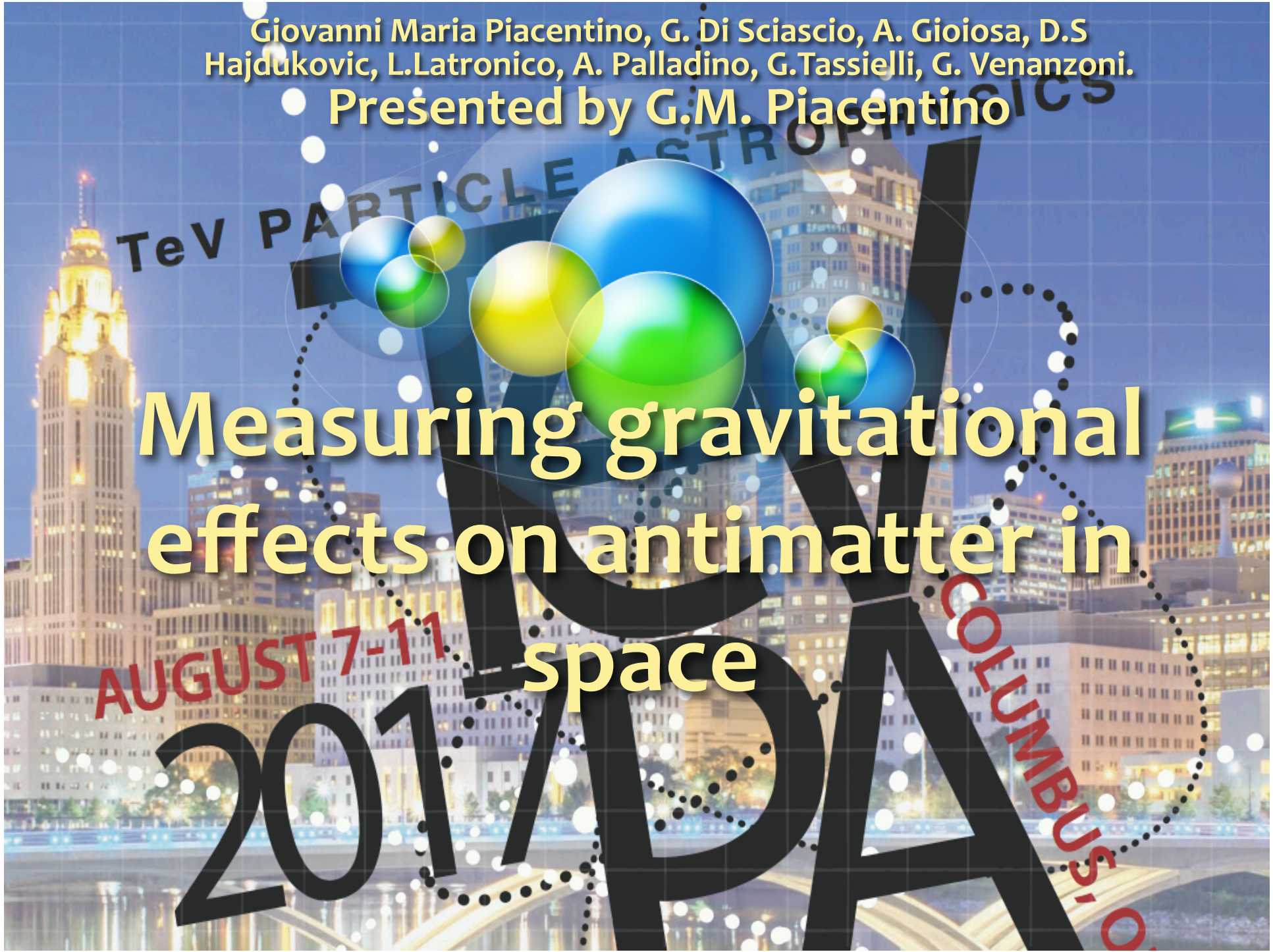

Open problems in Astrophysics and Cosmology

- i. In the observed Universe the matter prevails on antimatter even if both are always created together;
- ii. CMB is not anisotropic nor inhomogeneous enough to be compatible with the Big Bang model without the introduction of a still unknown interaction driving the inflation;
- iii. Given the gravity we expect a negative acceleration of the expansion. On the contrary that seems to accelerate;
- iv. The gravitational field of Galaxies, clusters and even of the Solar system seems much stronger the one due to the visible matter.

Present state of Possible solutions

- i. The mechanism suggested by Sakharov for matter/antimatter asymmetry is connected to CPV but experimentally this phenomenon is far too weak;
- ii. Models have been proposed to justify inflation by supersymmetric vacuum energy and SSB but at present no evidence for supersymmetry has been found yet;
- iii. Dark Energy has been introduced by hand in order to give a motivation to the accelerated expansion of the Universe;
- iv. Dark Matter has been introduced in order to give a motivation to the observed discrepancies between theory and measurements of the orbital speed of the stars of the external part of the galaxies.

WHY SO MANY DIFFERENT MOTIVATIONS?

From the point of view of the elegance the situation is far from being satisfactory:

- i. As many hypothesis as problems;
- ii. Most of them just put by hand into the theory;
- iii. Dark Matter and Dark Energy hypotheses are artificial.

Ockham's razor

- 🌐 This “lex parsimoniae” is due to the English Franciscan Scholar William of Ockham (1287-1347), who inspired the character of William of Baskerville in the Umberto Eco’s novel “The name of the Rose₁”. It can be presented as:
- 🌐 If there are several competing Hypotheses in order to explain a phenomenon or create a theory, The one that needs the fewest assumptions and parameters should be selected
- 🌐 1) *Le cose e i loro nomi*, Toraldo Di Francia [Laterza, 1986](#)

Can we master all the problems with a single Hypothesis?

 Let's start from Matter Antimatter symmetry:

- i. Matter is always produced with the corresponding antimatter;
- ii. Matter seems to dominate the landscape of the Universe;
- iii. No stable Antimatter seems to populate our Galaxy nor the Universe in general.

Strong, Weak and electromagnetic Interactions are limited in range

- 🌐 At the scale of 10^6 m even the electromagnetic interaction is mostly screened and the only residual interaction is the gravity;
- 🌐 At this scale no significant presence of antimatter can be found;
- 🌐 Is there any connection between absence of antimatter and presence of gravitation?

Repulsion?

- Antimatter particles correspond to negative energy solution;
- Could this correspond to a negative gravitational mass and to a consequent gravitational repulsion between matter and antimatter?

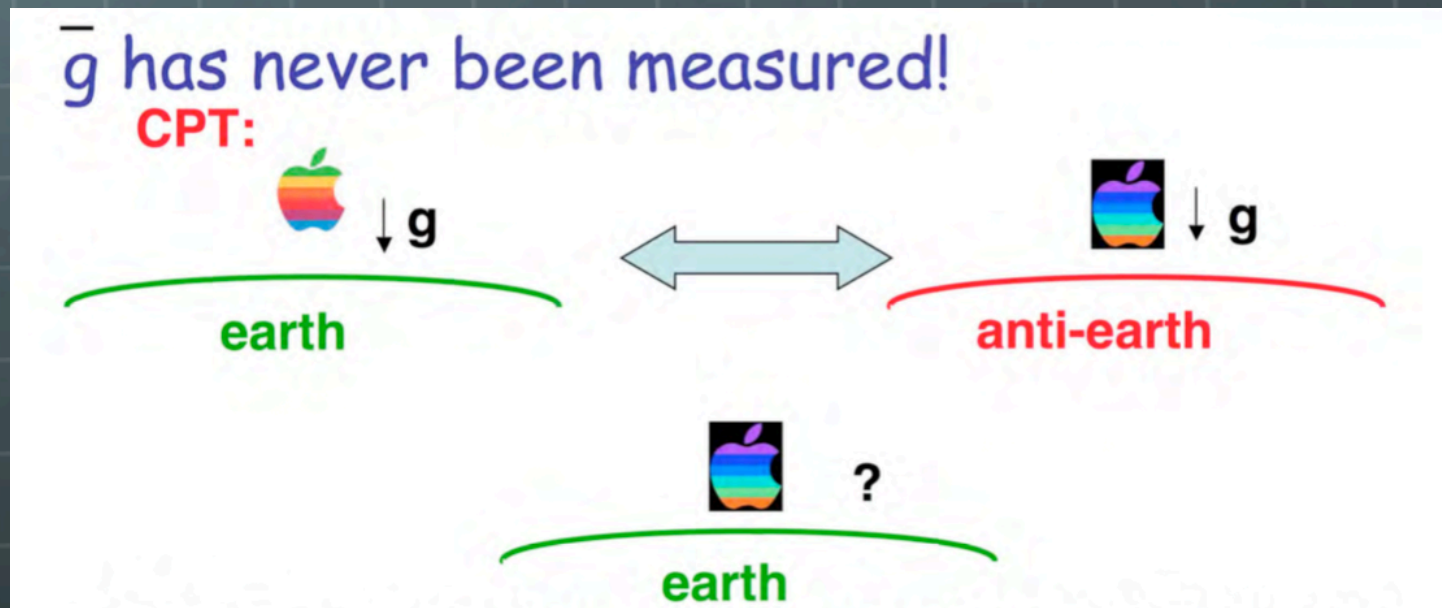

Suppose that gravitational interaction between matter and antimatter is repulsive

- 🌍 This could explain matter antimatter asymmetry;
- 🌍 This could be the nature of Dark Energy;
- 🌍 Repulsion could have powered the Inflation;
 - 🌍 An equal mix of matter and antimatter would give a net repulsive force
 - 🌍 This could even be the nature of the Dark Matter

Antimatter gravitational experiments

- 🌐 Witteborn & Fairbanks attempt to measure gravitational force on positrons
- 🌐 Los Alamos-led team proposed (1986) to measure gravitational force on antiprotons at the CERN Low Energy Antiproton Ring (LEAR)
- 🌐 Projects ended inconclusively
- 🌐 too various to describe here...
- 🌐 Many \bar{H} efforts in progress at CERN AD (ALPHA, ATRAP, ASACUSA, AEGIS, GBAR)

World leader: ALPHA* at CERN Antiproton Decelerator

- They make antihydrogen from p^- and e^+ in an octupolar trap then shut the magnet and see whether antihydrogen annihilate on the top or at the bottom.

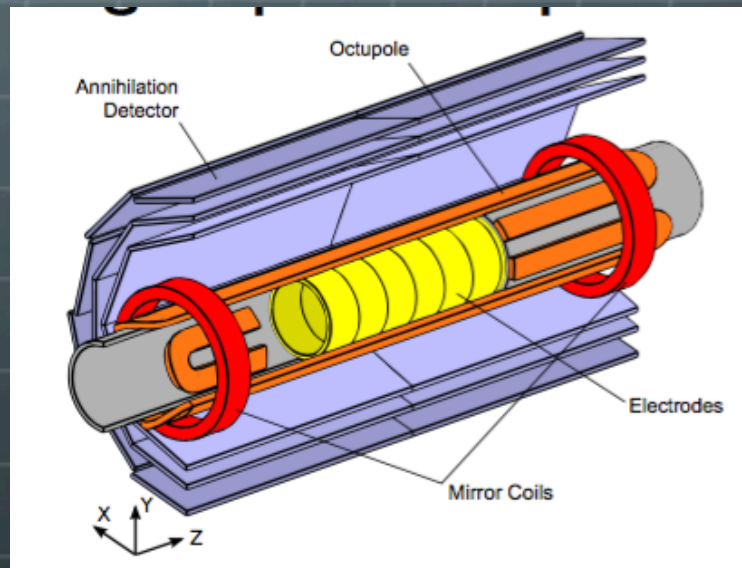

Interference, at CERN (AEgIS) and proposed at Fermilab (Phillips)

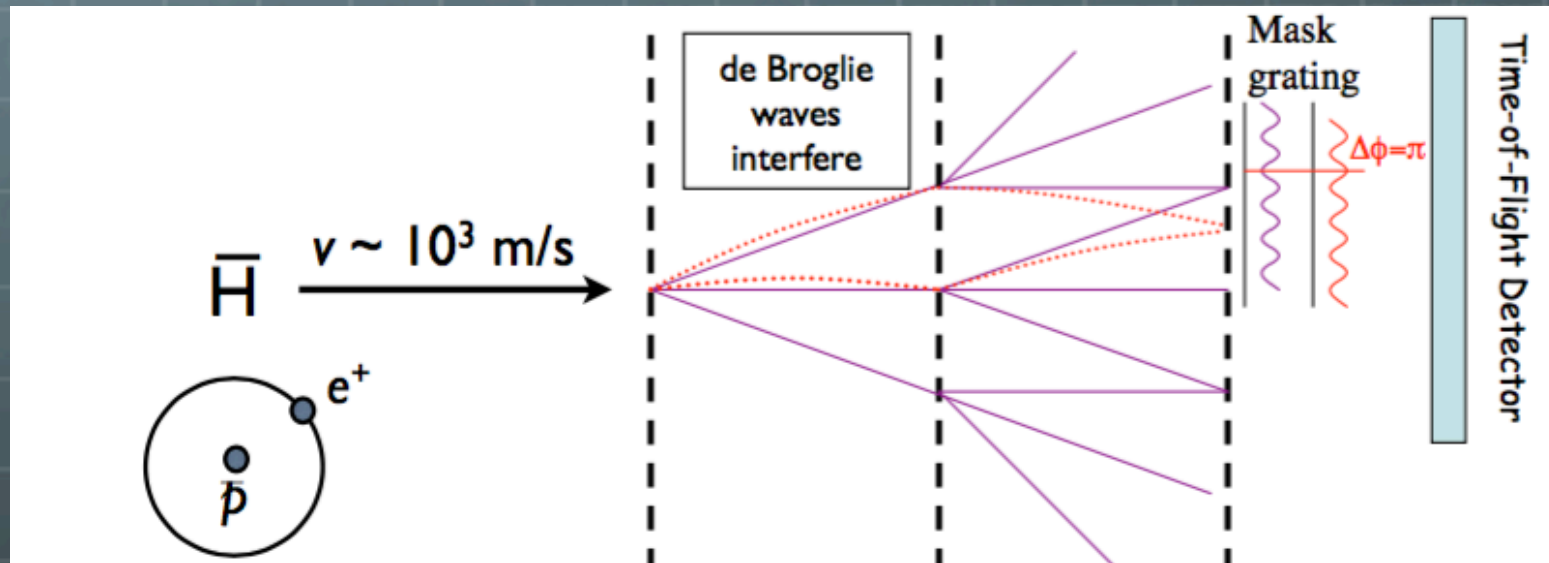

Testing Gravity with Muonium

K. Kirch*

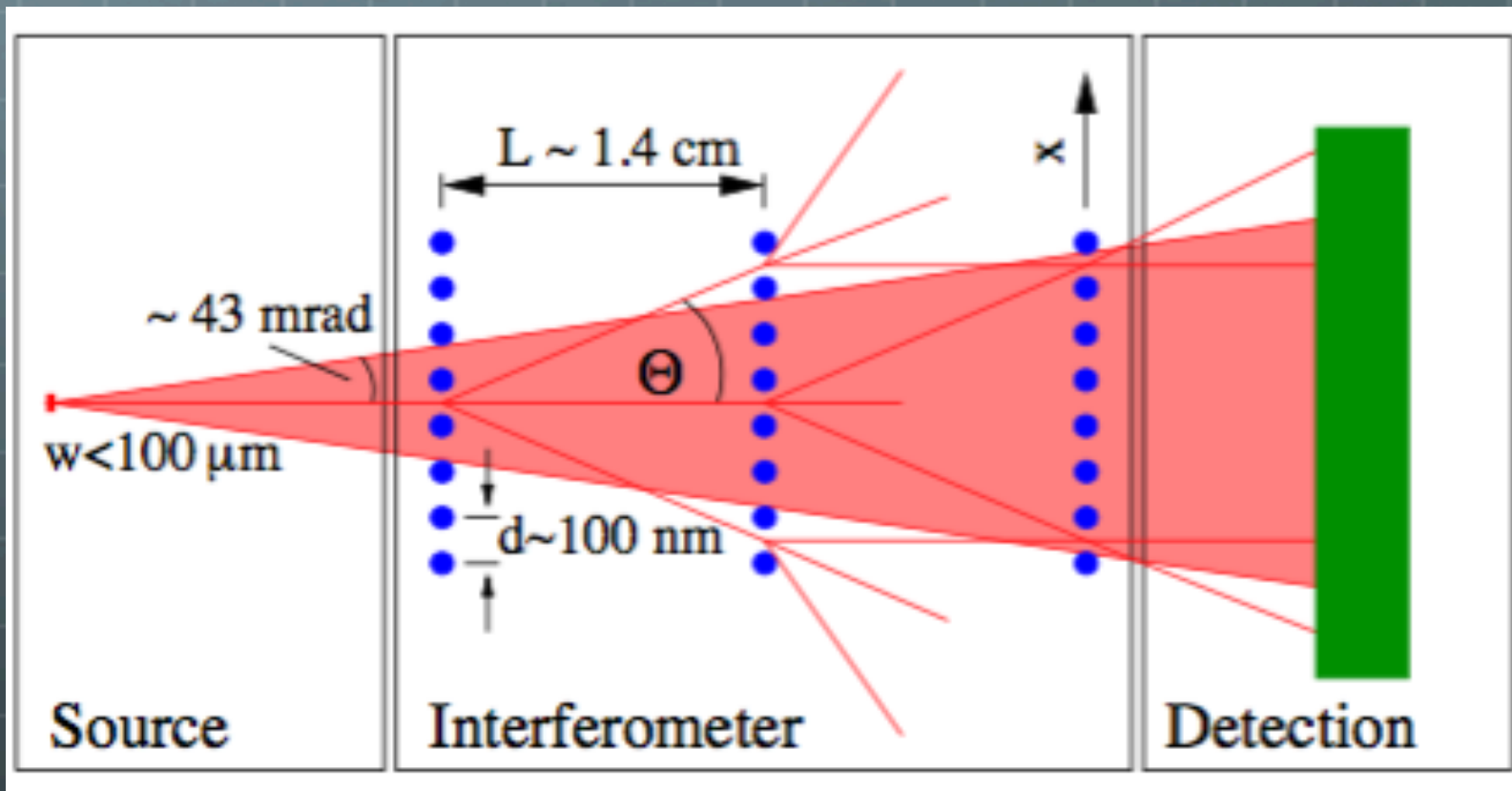

Paul Scherrer Institut (PSI), CH-5232 Villigen PSI, Switzerland



Antigravity and CPV from P. d. G.

 “Despite the phenomenological success of the KM mechanism, it fails (by several orders of magnitude) to accommodate the observed asymmetry [21]. This discrepancy strongly suggests that Nature provides additional sources of CP violation beyond the KM mechanism.”

CPV and Gravity

-  In the 1958, eight years before the discovery of CPV, Philip Morrison published on the American Journal of Physics a paper showing that a strong difference in the gravitational interaction for matter and antimatter could generate a CPV in neutral Kaons system.
-  **The CPV in neutral Kaons has been discovered 8 years later !!**

Let us restrict to CPV in the K_S - K_L system

Consider an indirect CPV:

- Indirect CP:

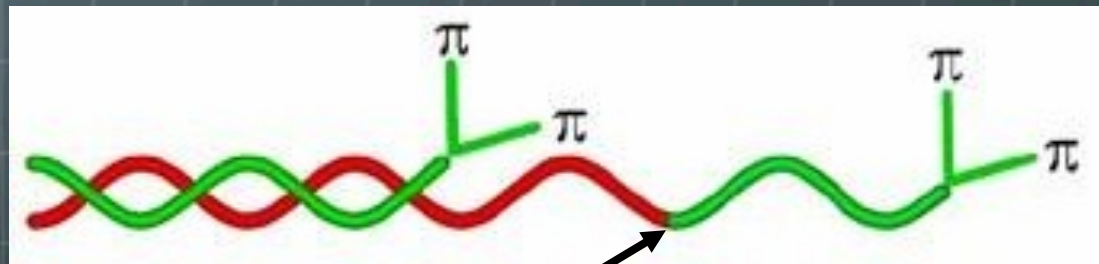

K_L 'mixes' to K_S before
decay **INDIRECT**

The gravitational field is described by the acceleration g so the components of antimatter and matter of a meson are divided by a distance growing with the time that can be written as:

$$\Delta \zeta = gt^2$$

The time useful for the phenomenon is a fraction $\Omega^{-1/2}$ of the mixing time $\Delta\tau$ where:

$$\Delta\tau = \frac{\pi\hbar}{\Delta mc^2} \approx 5.9 \times 10^{-10} \text{ s} \approx 6\tau_s$$

Where τ_s is the life time of K_s

The dimension of a K meson
is about 0.5 fm or:

$$\Delta L_k = \frac{\hbar}{m_k c}$$

The ratio:

$$\frac{\Delta \zeta}{\Delta L_k}$$

Is the adimensional
constant that
characterizes the
phenomenon

So we have:

$$\Omega \frac{g \frac{\pi^2 \hbar^2}{\Delta m^2 c^4}}{\frac{\hbar}{m_k c}} = \Omega \frac{\pi^2 \hbar g m_k}{\Delta m^2 c^3} = \Omega \times 0.88 \times 10^{-3}$$

And obtain the CPV parameter as:

$$\varepsilon = \Omega \frac{g \frac{\pi^2 \hbar^2}{\Delta m^2 c^4}}{\frac{\hbar}{m_k c}} = \Omega \frac{\pi^2 \hbar g m_k}{\Delta m^2 c^3} = \Omega \times 0.88 \times 10^{-3}$$

**This means that gravity could
be responsible for some of
the CPV in the neutral K seen
on the Earth**

CPV and Gravity

i. In 1992 Gabriel Chardin showed that gravity on Earth has the right intensity to generate CPV in the mixing of the neutral K and B mesons;

 He also demonstrated that the phenomenon of antigravity for antimatter could be compatible with the General Relativity and that it could be the motivation of an instability of quantum vacuum in the presence of strong gravitational fields, mimic of the Hawking radiation.

CPV and Gravity

- i. On a circular LEO at 500 Kilometers, gravity is about 10% less than on Earth. On a GEO orbit the intensity of the of the Earth's gravitational field is of the order of few percent. This is likely to cause a large fluctuation of any gravitational contribution to the CPV in the 2-state system of the neutral K mesons. • Furthermore in orbit, a large flux of energetic protons is present and is only mildly modulated by the Earth's magnetic field.

AMS

Primary proton spectrum. Data collected during the three periods with different zenith pointing criteria are combined. Kinetic energy is in GeV, flux in $(\text{m}^2 \text{sr s MeV})^{-1}$, ϵ_{stat} stands for the statistical error and $\epsilon_{\text{sys}(1,2,3)}$ for the systematic errors

Kinetic energy	Flux $\pm \epsilon_{\text{stat}} \pm \epsilon_{\text{sys}(1)} \pm \epsilon_{\text{sys}(2)} \pm \epsilon_{\text{sys}(3)}$
0.22 - 0.31	$(154. \pm 1.6 \pm 5.9 \pm 4.0 \pm 1.9) \times 10^{-2}$
0.31 - 0.44	$(156. \pm .99 \pm 6.0 \pm 3.8 \pm 1.3) \times 10^{-2}$
0.44 - 0.62	$(143. \pm .59 \pm 6.0 \pm 3.6 \pm 1.0) \times 10^{-2}$
0.62 - 0.85	$(120. \pm .39 \pm 4.6 \pm 3.1 \pm .82) \times 10^{-2}$
0.85 - 1.15	$(966. \pm 2.6 \pm 37. \pm 24. \pm 6.7) \times 10^{-3}$
1.15 - 1.54	$(738. \pm 1.8 \pm 28. \pm 18. \pm 5.1) \times 10^{-3}$
1.54 - 2.02	$(533. \pm 1.2 \pm 20. \pm 13. \pm 3.4) \times 10^{-3}$
2.02 - 2.62	$(372. \pm .80 \pm 14. \pm 8.9 \pm 2.7) \times 10^{-3}$
2.62 - 3.38	$(247. \pm .53 \pm 9.5 \pm 5.8 \pm 1.8) \times 10^{-3}$
3.38 - 4.31	$(161. \pm .33 \pm 6.2 \pm 3.7 \pm 1.3) \times 10^{-3}$
4.31 - 5.45	$(101. \pm .20 \pm 3.9 \pm 2.3 \pm .74) \times 10^{-3}$
5.45 - 6.86	$(630. \pm 1.3 \pm 24. \pm 14. \pm 5.2) \times 10^{-4}$
6.86 - 8.60	$(378. \pm .84 \pm 14. \pm 8.6 \pm 3.3) \times 10^{-4}$
8.60 - 10.7	$(226. \pm .54 \pm 8.7 \pm 5.2 \pm 2.0) \times 10^{-4}$
10.7 - 13.3	$(135. \pm .36 \pm 5.2 \pm 3.1 \pm 1.5) \times 10^{-4}$
13.3 - 16.5	$(786. \pm 2.3 \pm 30. \pm 18. \pm 10.) \times 10^{-5}$
16.5 - 20.5	$(449. \pm 1.5 \pm 17. \pm 11. \pm 6.6) \times 10^{-5}$
20.5 - 25.3	$(266. \pm .98 \pm 10. \pm 6.4 \pm 4.3) \times 10^{-5}$
25.3 - 31.2	$(148. \pm .61 \pm 5.7 \pm 3.7 \pm 2.7) \times 10^{-5}$
31.2 - 38.4	$(856. \pm 4.0 \pm 33. \pm 22. \pm 16.) \times 10^{-6}$
38.4 - 47.3	$(496. \pm 2.7 \pm 19. \pm 13. \pm 9.2) \times 10^{-6}$
47.3 - 58.2	$(284. \pm 1.8 \pm 11. \pm 7.9 \pm 5.7) \times 10^{-6}$
58.2 - 71.5	$(154. \pm 1.2 \pm 5.9 \pm 4.4 \pm 3.0) \times 10^{-6}$
71.5 - 87.8	$(86.2 \pm .80 \pm 3.3 \pm 2.4 \pm 1.7) \times 10^{-6}$
87.8 - 108.	$(49.4 \pm .55 \pm 1.9 \pm 1.3 \pm .94) \times 10^{-6}$
108. - 132.	$(29.0 \pm .40 \pm 1.1 \pm .78 \pm 1.1) \times 10^{-6}$
132. - 162.	$(16.4 \pm .27 \pm .63 \pm .44 \pm .80) \times 10^{-6}$
162. - 199.	$(9.39 \pm .18 \pm .36 \pm .25 \pm 1.0) \times 10^{-6}$



CPV and Gravity

- 🌐 On a square target of 70 cm of side, about 1.4×10^4 protons per second will impact, The energy of the cosmic protons ranges from a few MeV to ~ 200 GeV with the maximum flux around 1 GeV and several smaller local maxima at 5, 13, and 31 GeV. This spectrum can produce the neutral Kaons. The total number of K mesons decays over a space mission lifetime (> 2 years) will yield the required physical measurement.

A dedicated Satellite

- 🌐 WE suggest the use of a dedicated Satellite
- 🌐 Our payload is aimed at performing a particle physics experiment in orbit with active target, magnetic spectrometer, tracker and calorimeter
- 🌐 Active Target: We simulated the production of the K_L “long” (long decay neutral mesons) and K_S (“short”) mesons by the cosmic protons on an appropriate target

Active Target

Tracker Layers

RICH

ECAL 28

Permanent Magnet

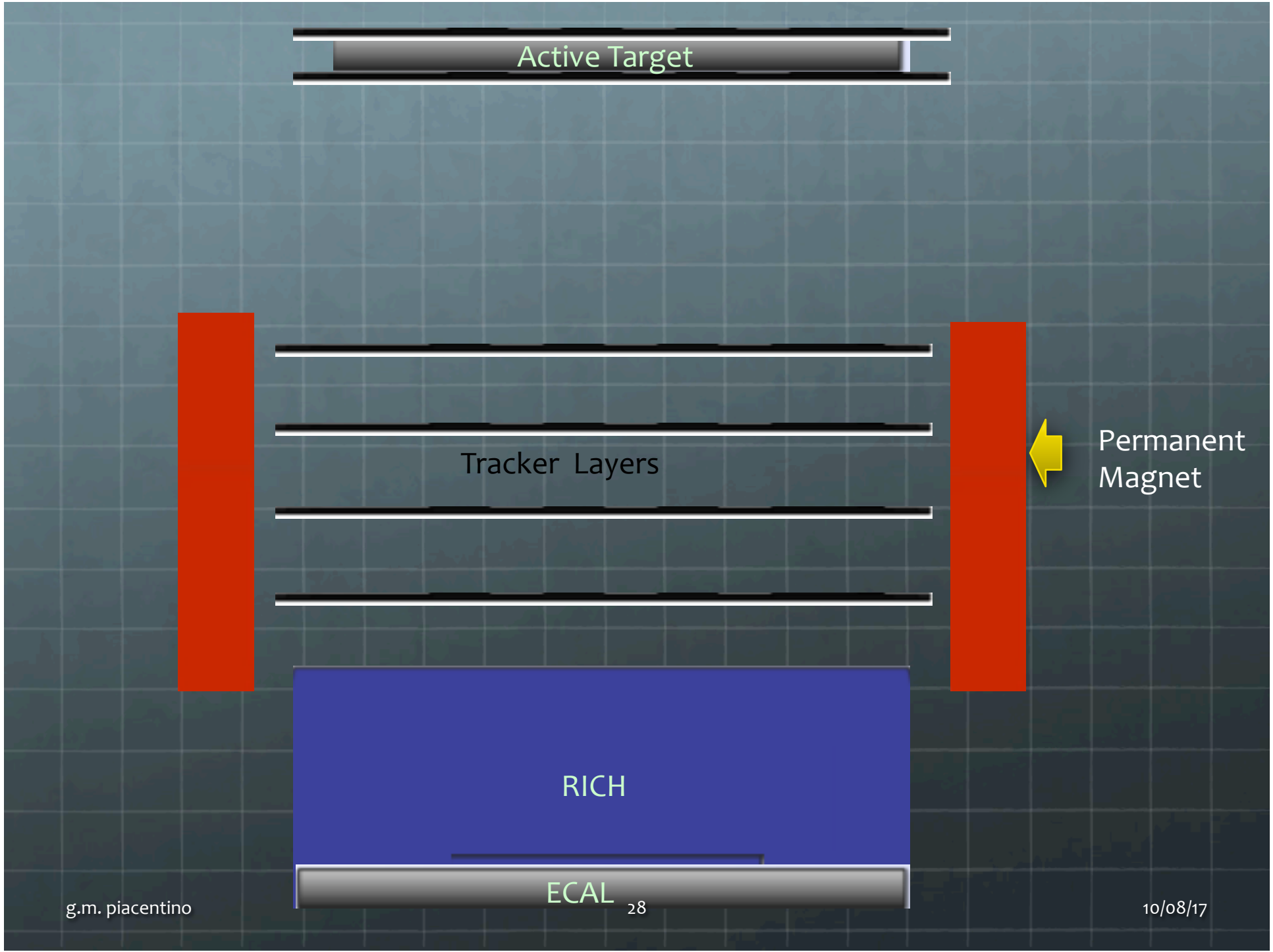

K_{long} production

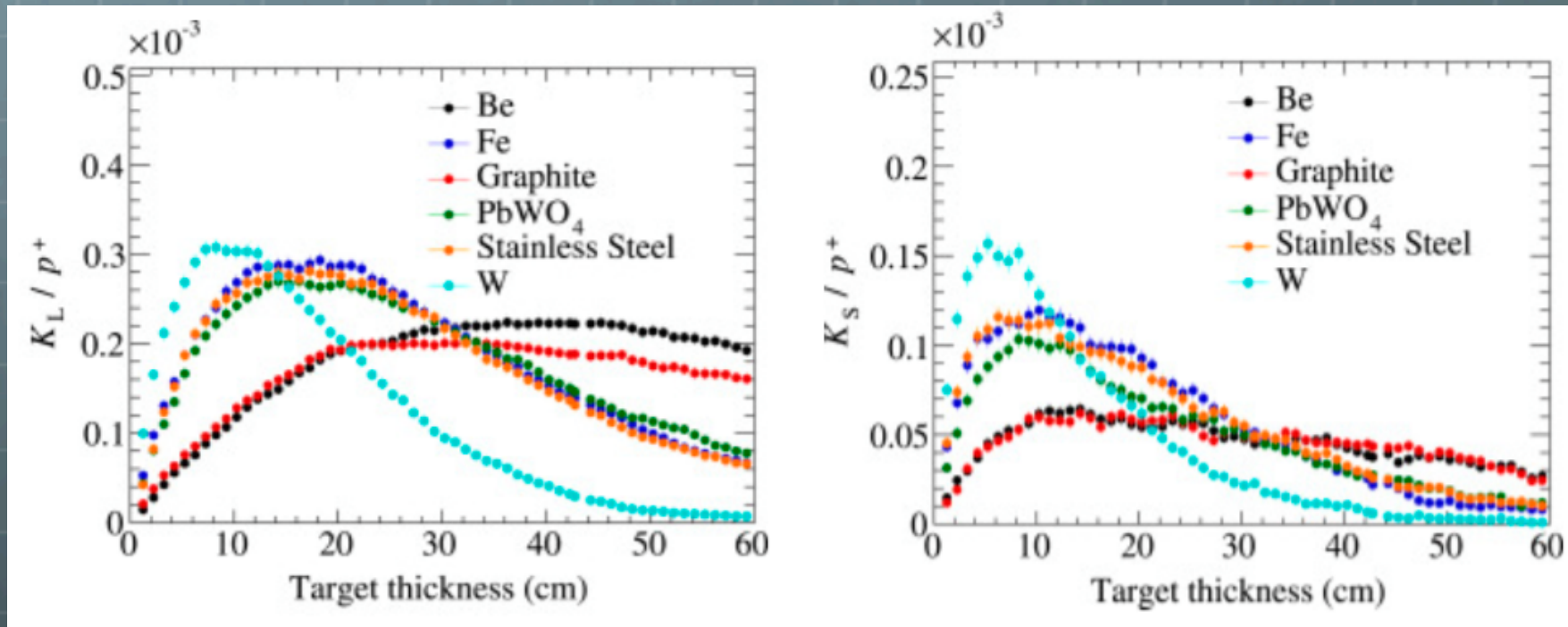

- 🌐 G. M. Piacentino, A. Palladino and G. Venanzoni, "Measuring gravitational effects on antimatter in space,"
- 🌐 Phys. Dark Univ. **{\bf 13}** (2016) 162.

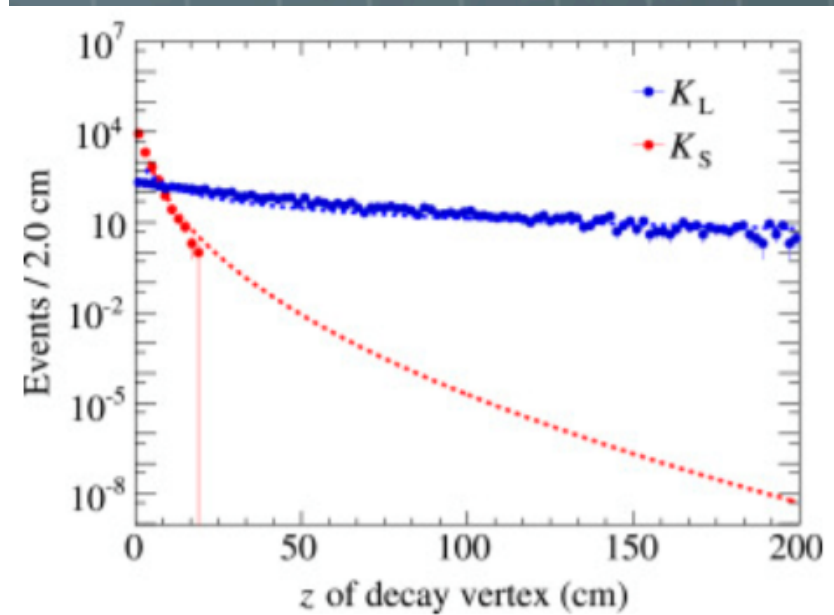
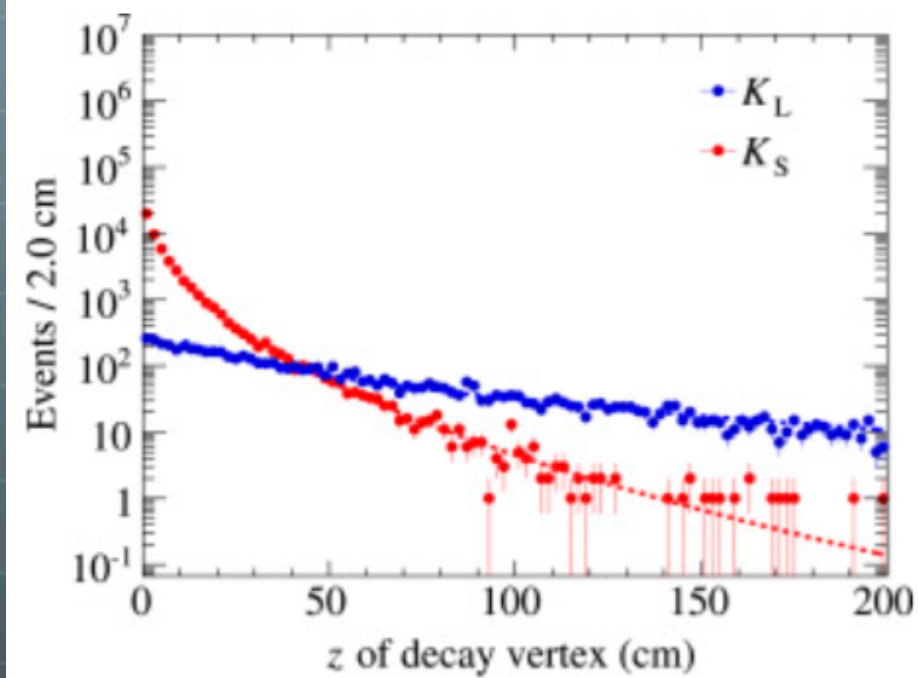

- 🌐 G. M. Piacentino, A. Palladino and G. Venanzoni, "Measuring gravitational effects on antimatter in space,"
- 🌐 Phys. Dark Univ. **13** (2016) 162

conclusions

- 🌍 We have proposed a possible test of the gravitational behavior of antimatter by measuring the rate of the CP violating decay in space. We estimate that:
- 🌍 5σ measurement of a possible change in the CP violation parameter ϵ could be obtained within some years, depending on the detection efficiency, if one places a detector with a 9 cm thick tungsten target, a 1 m diameter by 1 m deep tracking region, a magnetic field for charged-particle identification, time-of-flight counters, and electromagnetic calorimeters for energy measurements, on a Leo or better on Geostationary orbit. Any difference between the amount of CP violation in orbit with respect to the level CP violation on the Earth's surface would be an indication of the nature of the gravitational interaction between matter and antimatter. A positive result may offer an explanation for the cosmic baryon asymmetry and may offer a contribution to the observed effects thought to come from dark matter and dark energy