

2023/01/24

Advances in Astroparticle Physics and Cosmology (AAPCOS-2023)



# Direct Detection of Dark Matter at SNOLAB

---

**Jeter Hall**

SNOLAB/Laurentian University



# Outline

---

- **Few words about dark matter**
- An introduction to SNOLAB
- A tour of the 9 active/under construction/under design direct detection experiments



# The evidence for dark matter are unambiguous

Mario De Leo/wikipedia

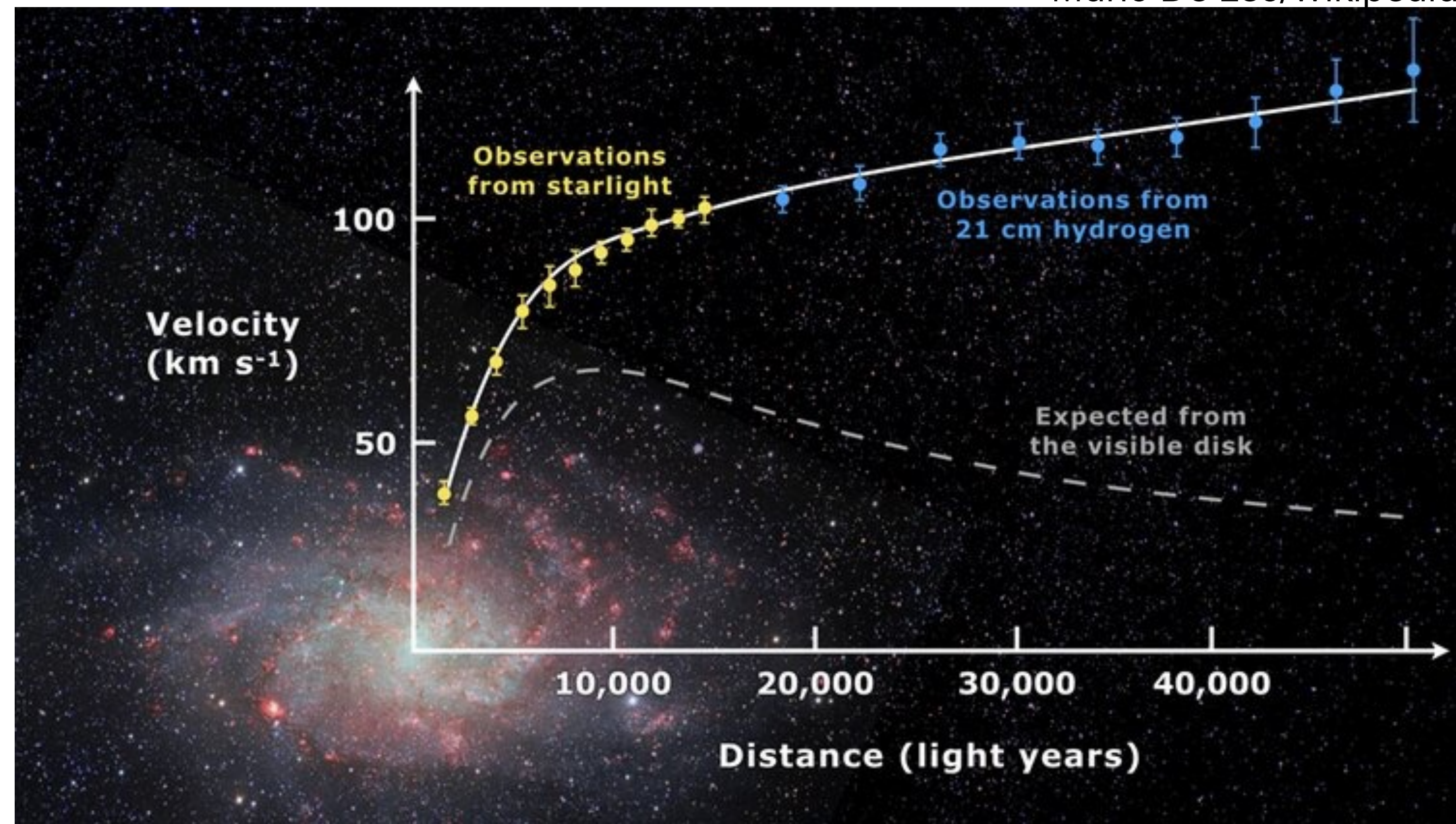

The theory of gravity and/or the theory of matter must change to explain these data.



# The search for the nature of dark matter is growing and expanding

“Delve deep, search wide”

Look as many ways as you can imagine...

How do we search for something if you don't know what it is?

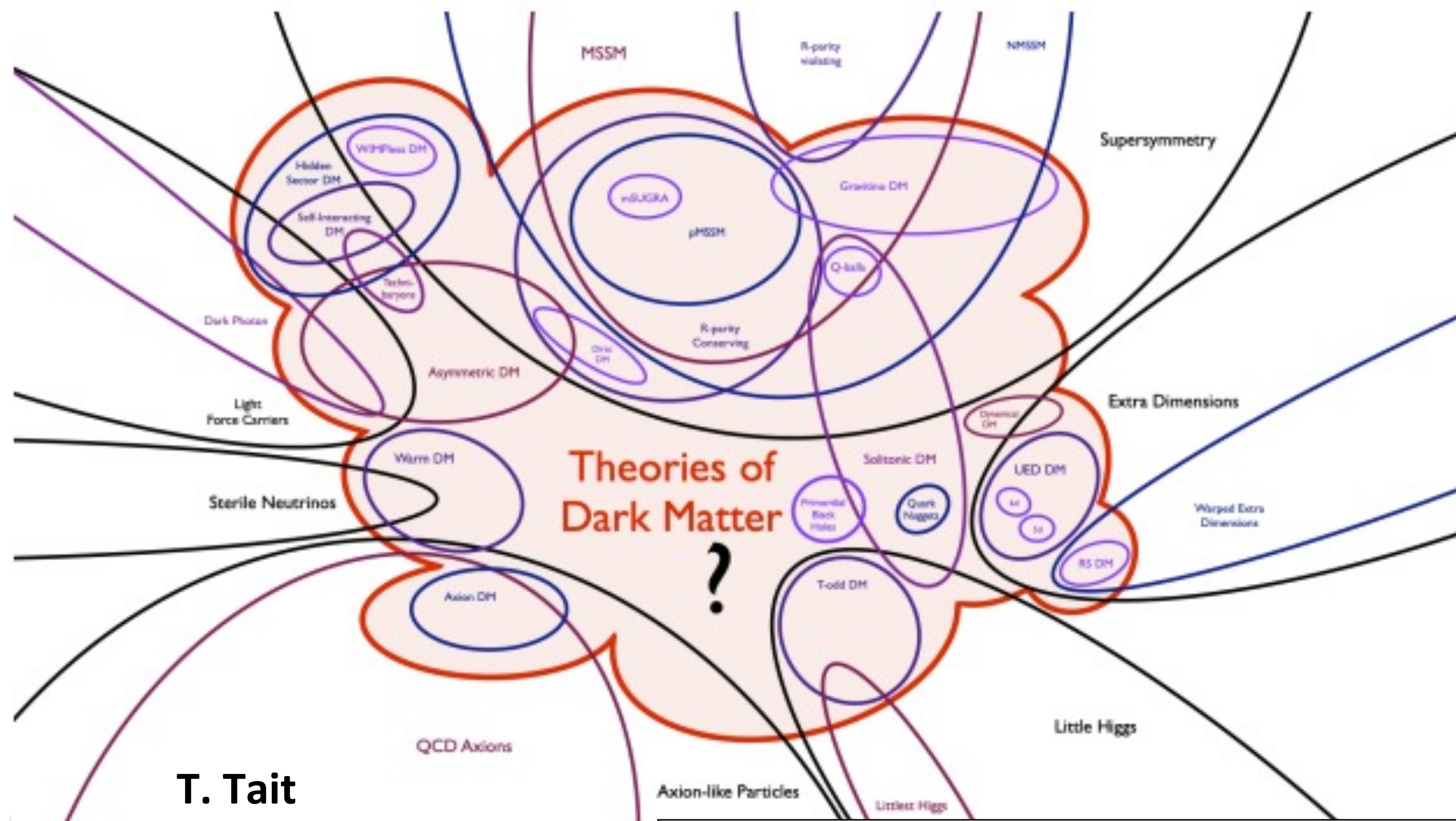

T. Tait

See... many talks from this conference!

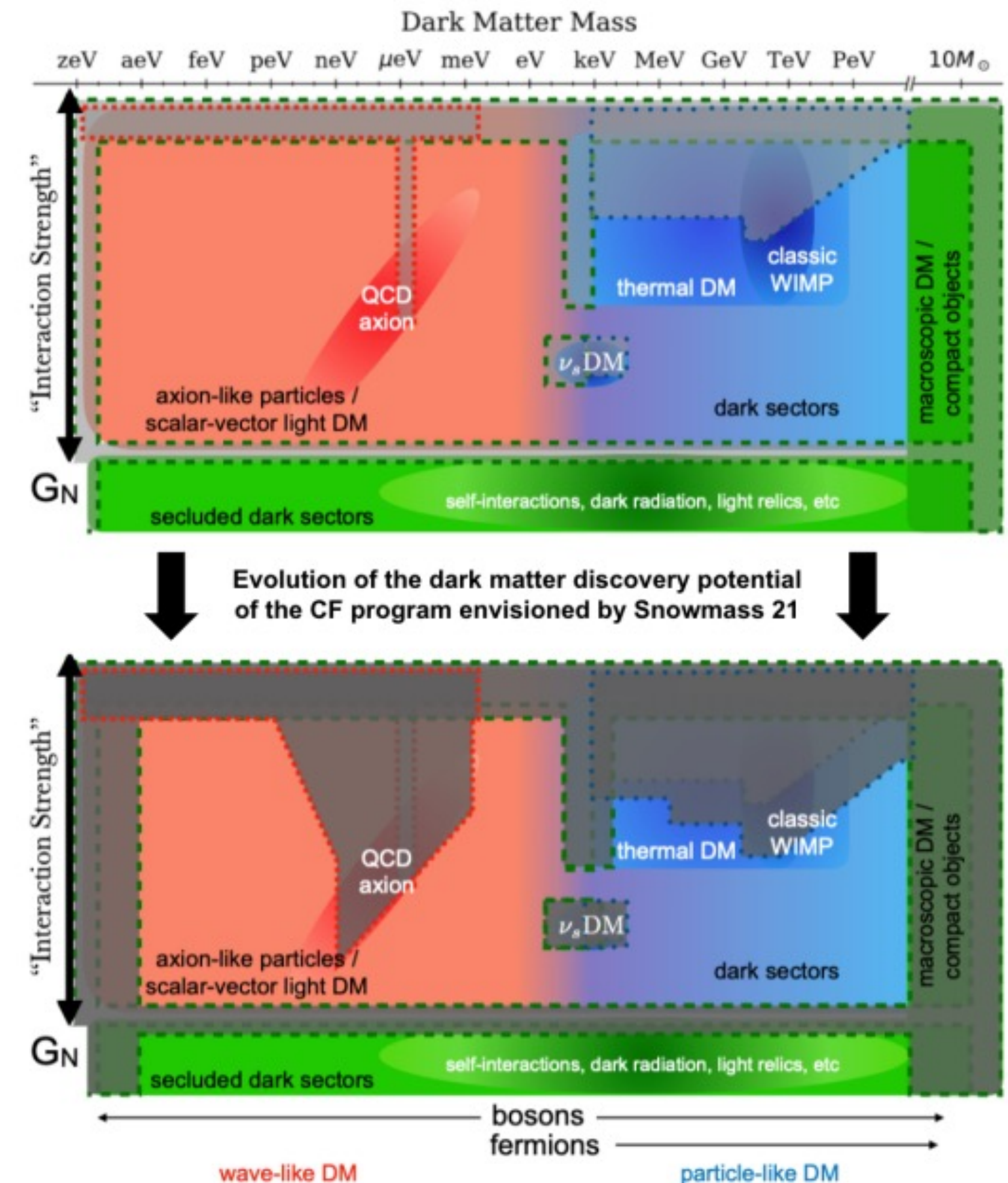



# Direct detection of dark matter looks for dark matter particles scattering on terrestrial detectors

- Direct detection compliments other dark matter searches
  - Collider/Fixed target searches for exotic particle production
  - Astronomical observations

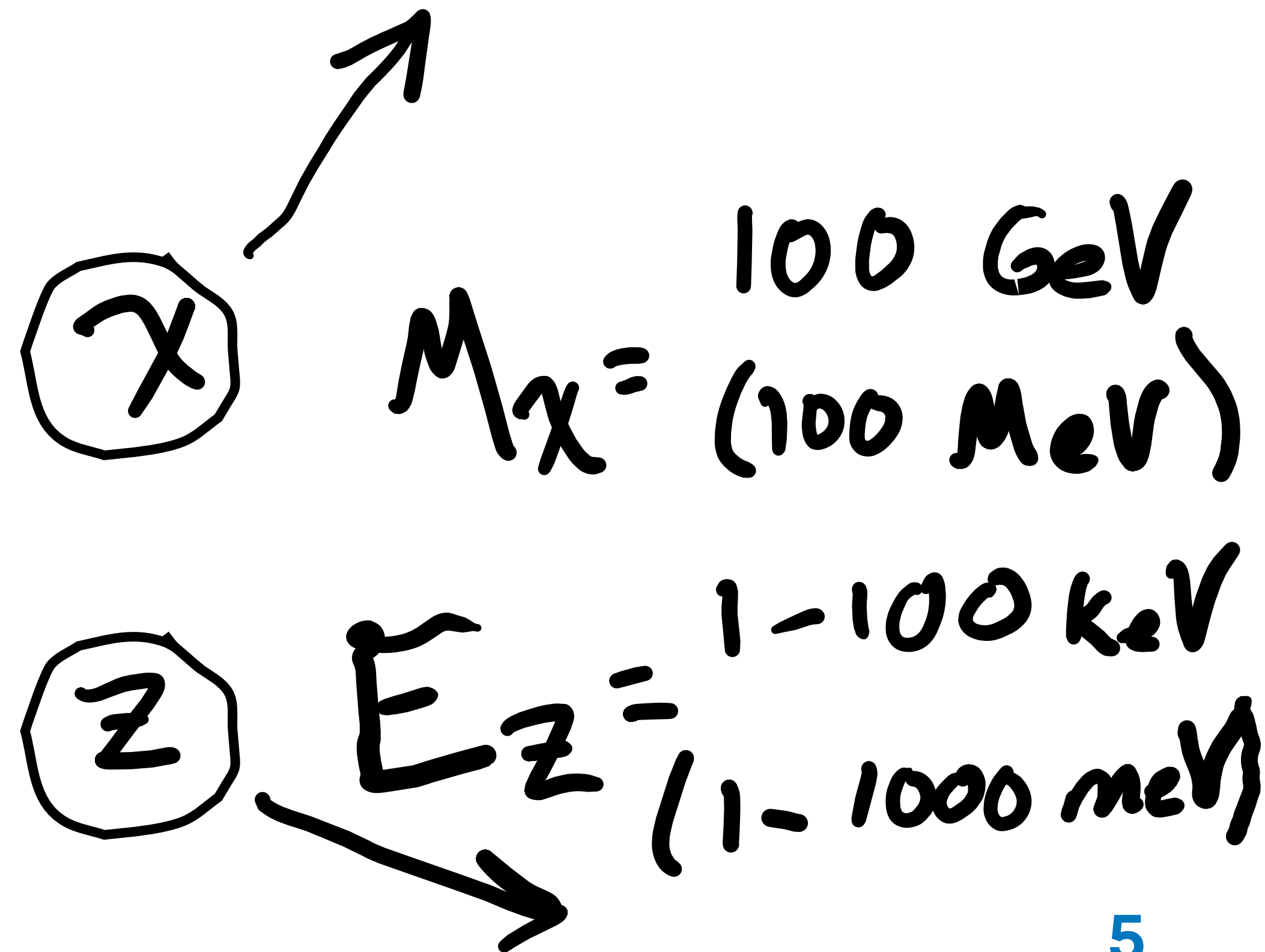
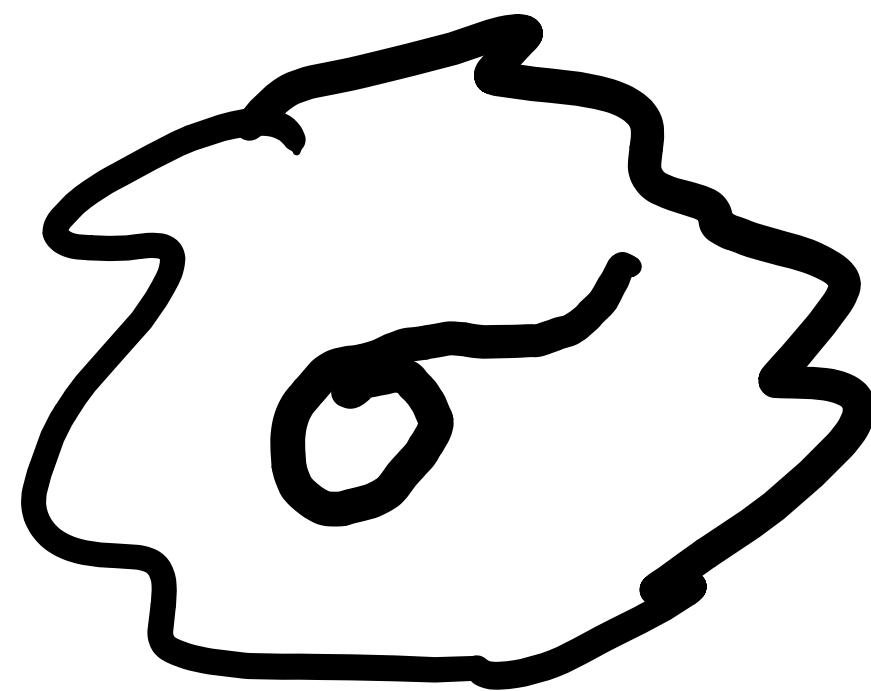
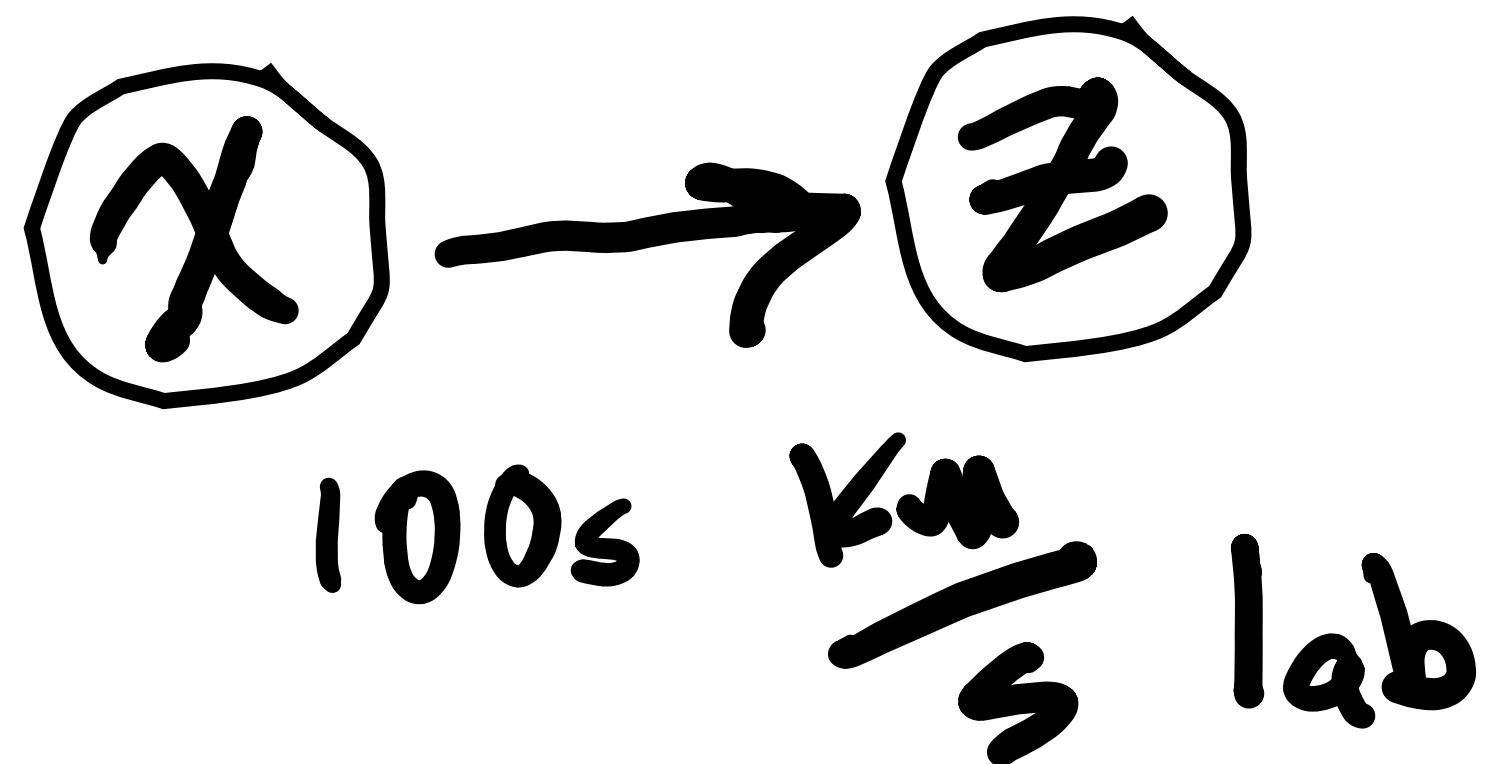



# Direct detection of dark matter experiments often focus on removing backgrounds, which is all around us

- Radiation detection methods are subject to radiation backgrounds
- Direct detection experiments must reject these backgrounds to search for this hypothesized component in the radiation background





# Outline

---

- Few words about dark matter
- **An introduction to SNOLAB**
- A tour of the 9 active/under construction/under design direct detection experiments



# SNOLAB



---

SNOLAB hosts rare event searches and measurements. It's located 2 km underground in the active Vale Creighton nickel mine near Sudbury, Ontario, Canada.

SNOLAB is operated jointly by University of Alberta, Carleton University, Laurentian University, University of Montreal, and Queen's University

SNOLAB operations are funded by the Province of Ontario, and the Canada Foundation for Innovation



# Land Acknowledgment

---

SNOLAB is located on the traditional territory of the Robinson-Huron Treaty of 1850, shared by the Indigenous people of the surrounding Atikameksheng Anishnawbek First Nation as part of the larger Anishinabek Nation.

We acknowledge those who came before us and honour those who are the caretakers of the land and the waters.



# SNOLAB is *underground* to shield high energy radiation from space, and *clean* to remove backgrounds from dirt



- Astrophysical systems emit high energy radiation which create muons in Earth's atmosphere
- 2 km granite shield
- SNOLAB has the lowest muon fluxes available
- Clean room throughout the underground facility
  - Dirt is high in radioactivity to us
- Growing community of users
- Dark matter searches require low backgrounds

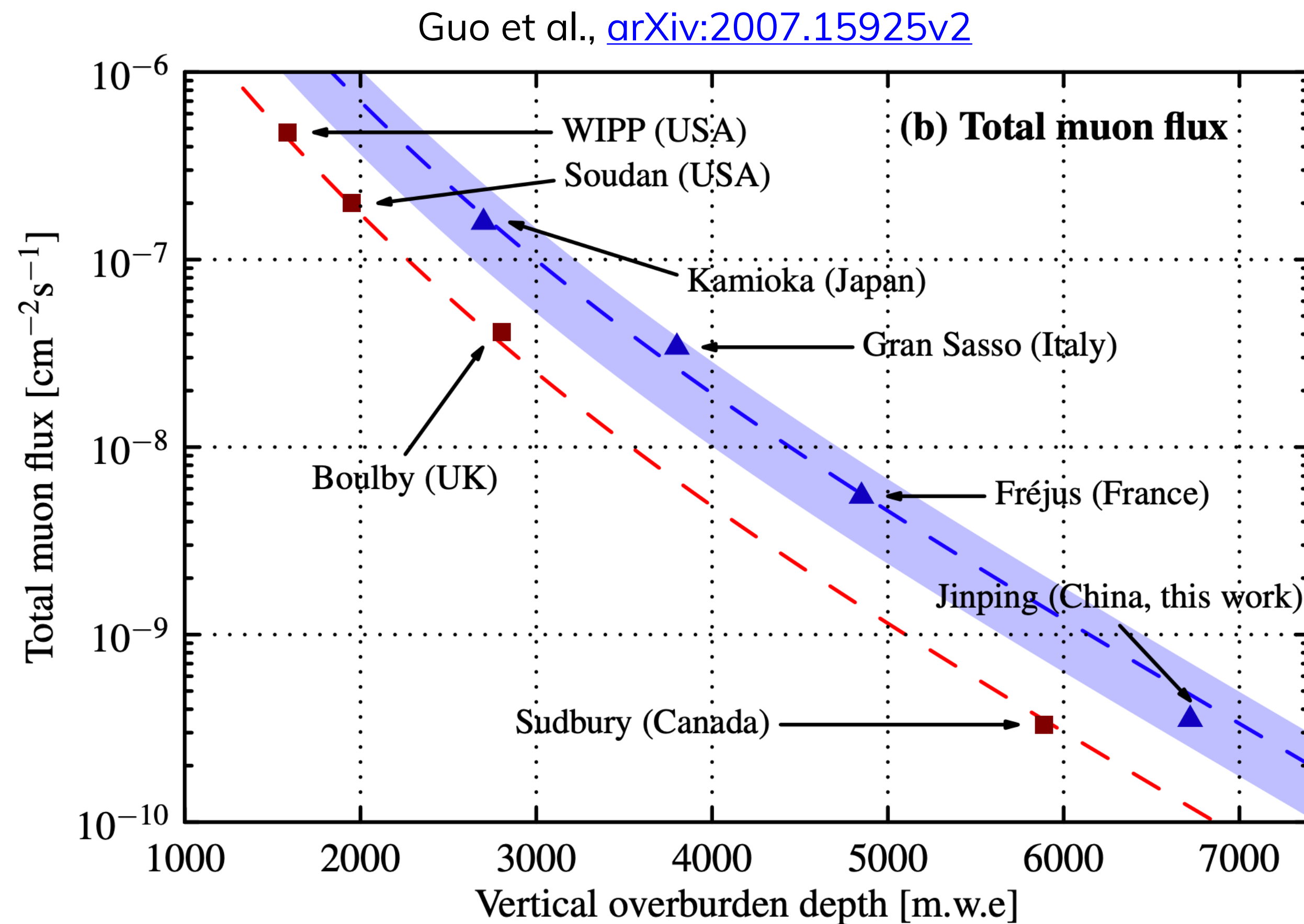



# The main SNOLAB laboratory is 2 km underground

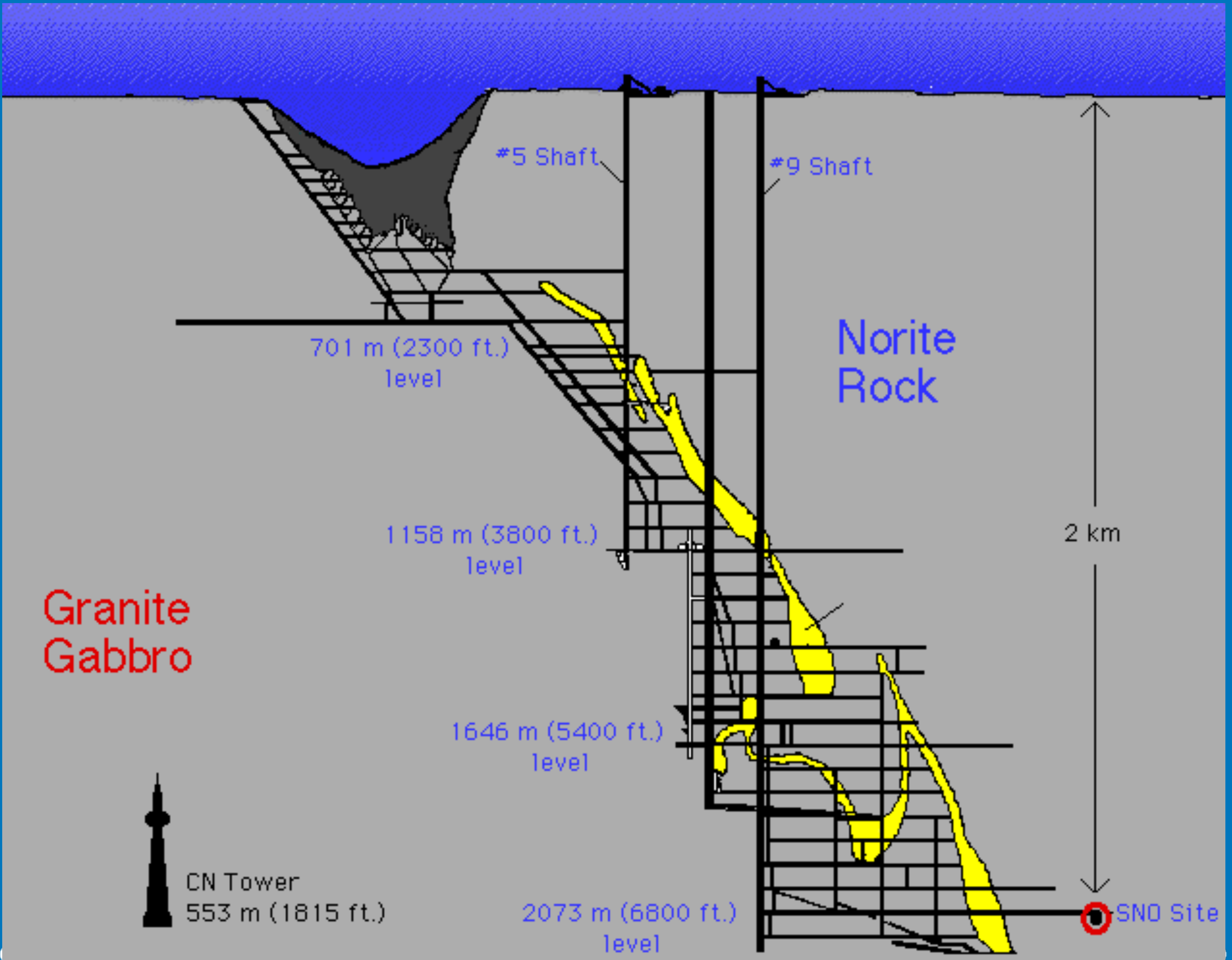

[“A visit to SNOLAB” on YouTube](#)



# SNOLAB layout

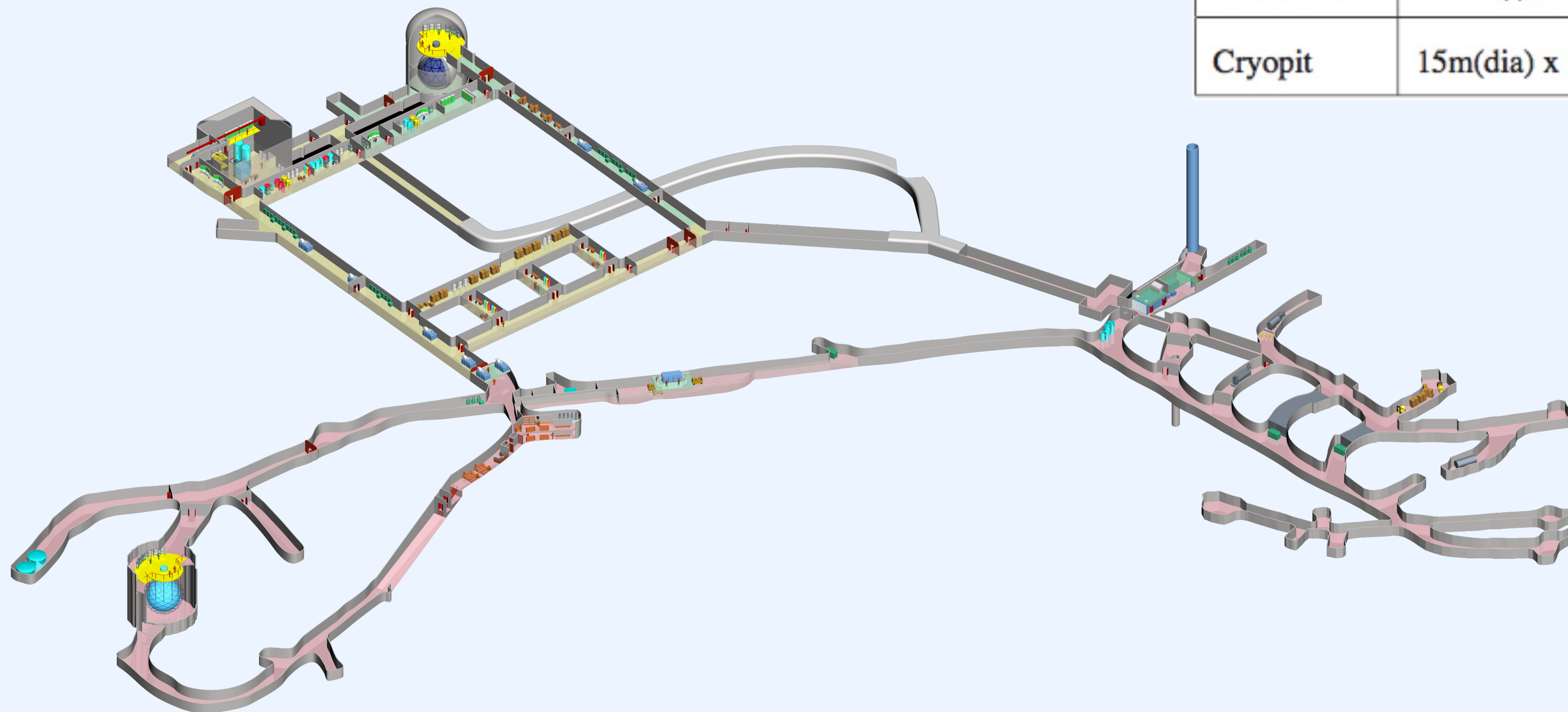

Area	Dimensions	Area	Volume
SNO Cavern	24m (dia) x 30m(h)	250m <sup>2</sup>	9,400 m <sup>3</sup>
Ladder Labs	32m(l)x6m(w)x5.5m(h)	190m <sup>2</sup>	960 m <sup>3</sup>
	23m(l)x7.5m(w)x7.6m(h)	170m <sup>2</sup>	1,100 m <sup>3</sup>
Cube Hall	18.3m(l)x15m(w) x 19.7m(h)	280m <sup>2</sup>	5,600 m <sup>3</sup>
Cryopit	15m(dia) x 19.7m(h)	180m <sup>2</sup>	3,900 m <sup>3</sup>

5000 m<sup>2</sup> of class 2000 cleanroom underground.  
<2000 particles >0.5 μm in diameter per ft<sup>3</sup>



# SNOLAB people enable science

---

SNOLAB has a focus on User Support

- Scientific
- Engineering
- Construction
- Operations

Sudbury hosts a strong mining/industrial base that projects can draw from

- Excavation
- Fabrication
- Integration

Laurentian University is the research anchor for the user base





# Cleanliness is critical to SNOLAB operations and science

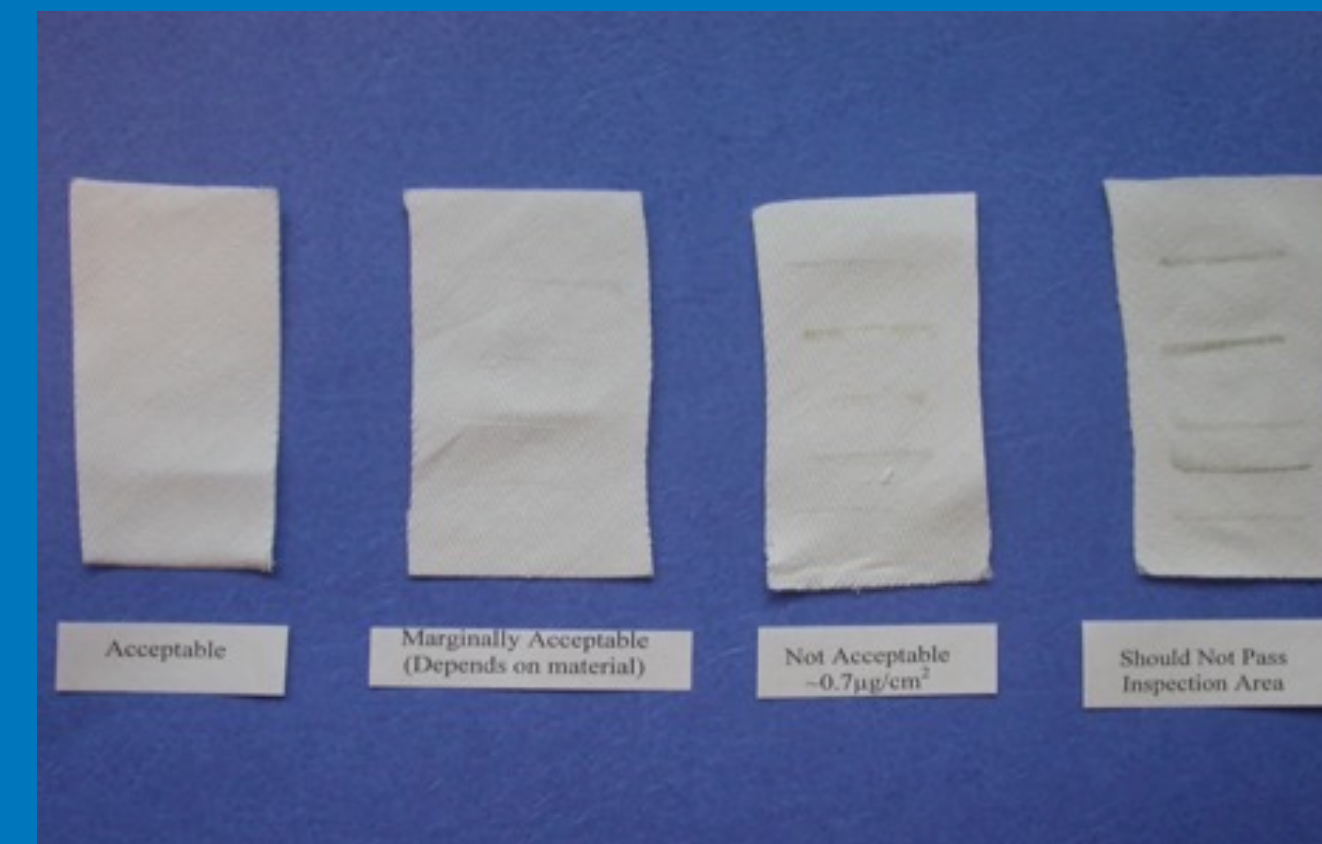



# Dust Collection at SNOLAB

[arXiv:2006.12746](https://arxiv.org/abs/2006.12746)

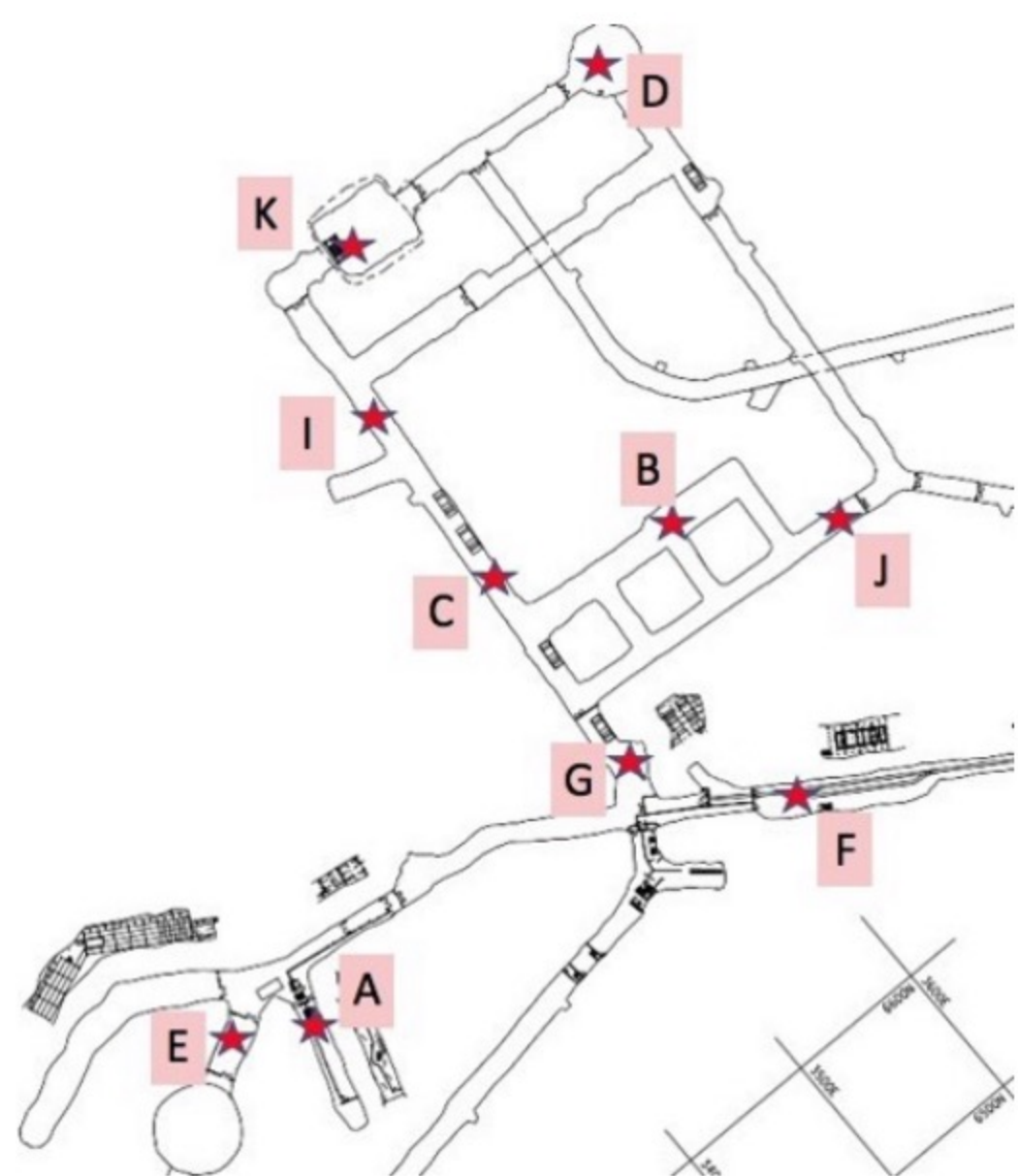

9 underground cleanroom locations  
 1 underground non-cleanroom location  
 1 non-cleanroom location in the surface building  
 August 2018 ( $\approx$  40-day exposure, including 20 days of mine shutdown)

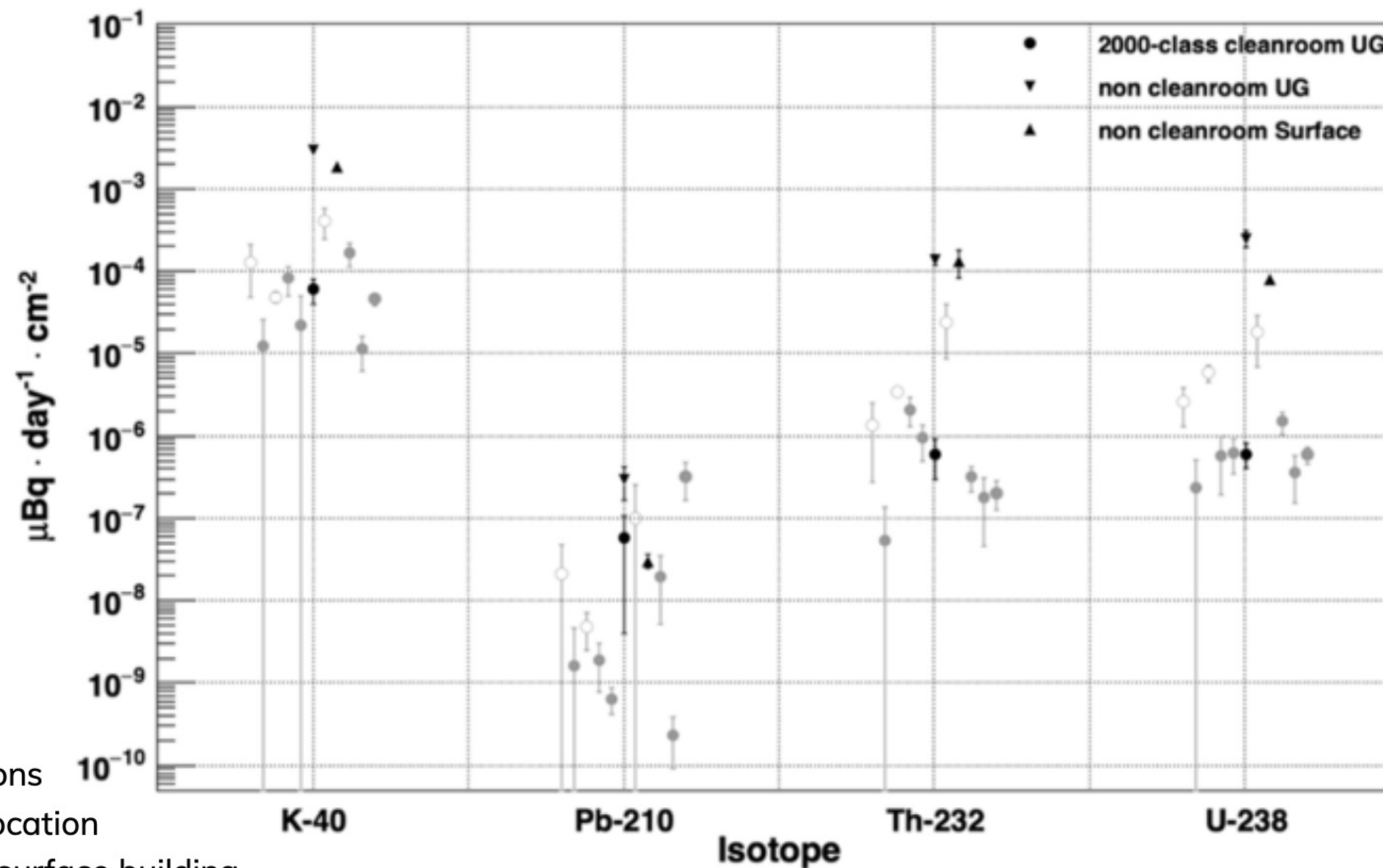

Cleanrooms*	
[mBq · day <sup>-1</sup> · cm <sup>-2</sup> ]	
K-40	$(5.7 \pm 5.9) \times 10^{-5}$
Pb-210	$(5.7 \pm 13) \times 10^{-8}$
Th-232	$(6.3 \pm 7.8) \times 10^{-7}$
U-238	$(6.5 \pm 4.4) \times 10^{-7}$

\* Excluding 3 cleanroom locations where activities may have triggered higher accumulation rates (empty circle markers)



# Science Strategy

**The science at SNOLAB is** currently focused on fundamental particle physics. Primarily looking at further **investigating the nature of matter**. Specifically:

- What is **the nature of dark matter**?
- What is the nature of the neutrino?

SNOLAB is interested in collaborating on any scientific research that requires deep underground facilities. For example:

- Neutrino observatories (solar, supernovae, geo, reactor, etc.)
- Effects of radiation on biological systems
- Environmental monitoring (nuclear non-proliferation, aquifers, etc.)
- Effects of radiation on quantum technologies

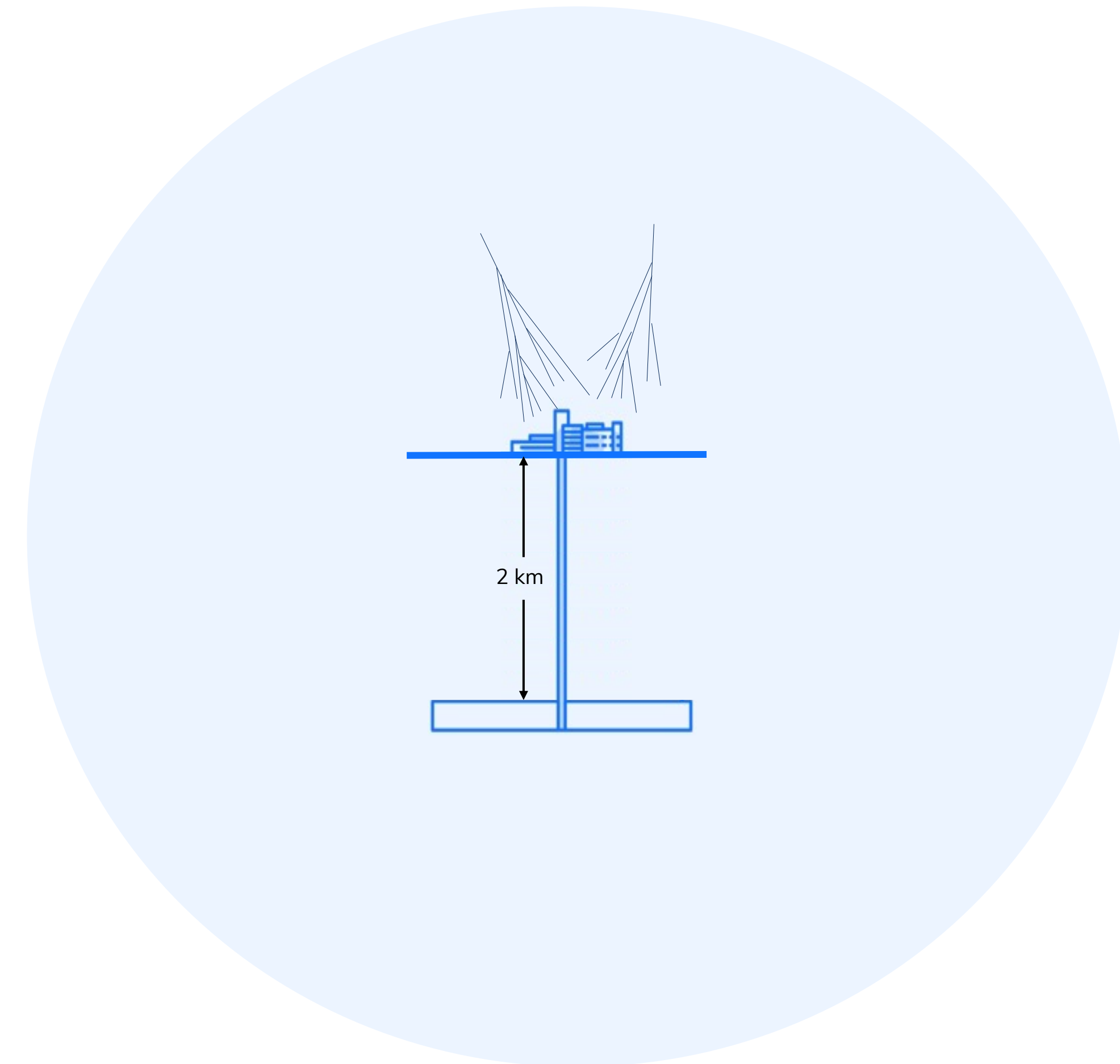

# Outline

---

- Few words about dark matter
- An introduction to SNOLAB
- **A tour of the 9 active/under construction/under design direct detection experiments**
  - Organized by ~~number of dark matter observations~~ technology



# Direct detection of dark matter experiments use low background radiation detection techniques

---

- Count individual energy quanta
  - Energy is detected via heat, ionization, and/or scintillation
- The experiments at SNOLAB utilize all these techniques
  - Bubble chambers and cryogenic detectors measure heat
    - PICO, SBC, SuperCDMS
  - Semiconductors and gas detectors detect ionization
    - DAMIC, SENSEI, Oscura, NEWS-G, SuperCDMS
  - Liquid argon scintillates well
    - DEAP-3600, SBC

# The direct detection of dark matter experiments are currently the most common experiment type at SNOLAB

---

- DEAP-3600, PICO-40, PICO-500, SBC, DAMIC, SENSEI, Oscura, NEWS-G, and SuperCDMS
- All omissions/errors are mine, the beautiful experimental work is done by the collaborations



# Bubble Chambers for Dark Matter Search

Courtesy of PICO Collaboration

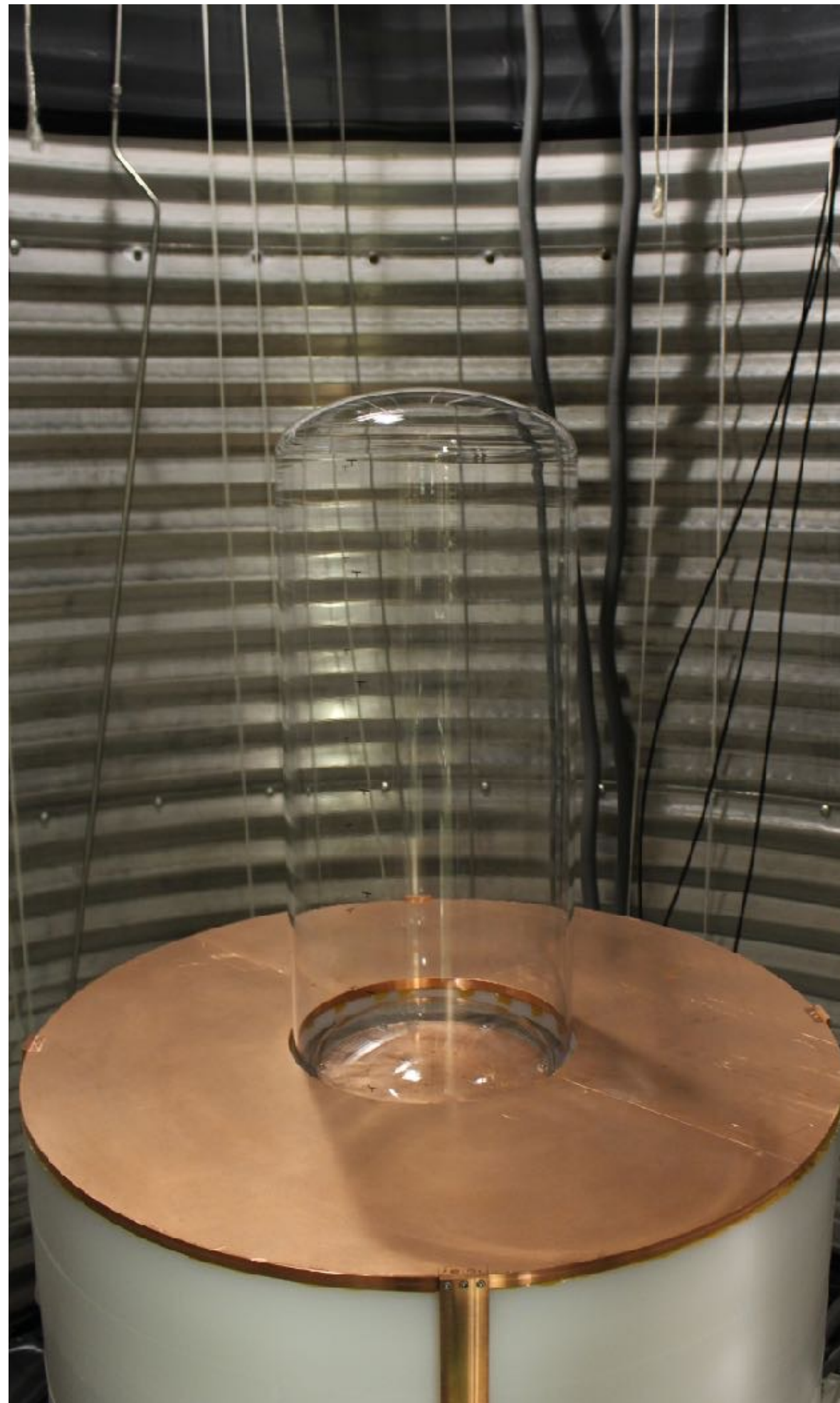

- Bubble chambers are vessels with a superheated liquid that is observed by a camera (invented by Glaser in 1952, Nobel Prize 1960)
- The threshold of a bubble chamber can be changed over a large range by adjusting temperature and pressure inside the active liquid, in case of PICO chambers  $C_3F_8$
- Bubble chamber have an excellent sensitivity to particle interactions. Modern PICO-style bubble chambers can be active for extended periods of time to maximize the dark matter exposure

# The concept

- PICO is a world-leading dark matter search detector
  - Background discrimination is one of the reasons
- As the focus shifts to lower masses, this discrimination reduces

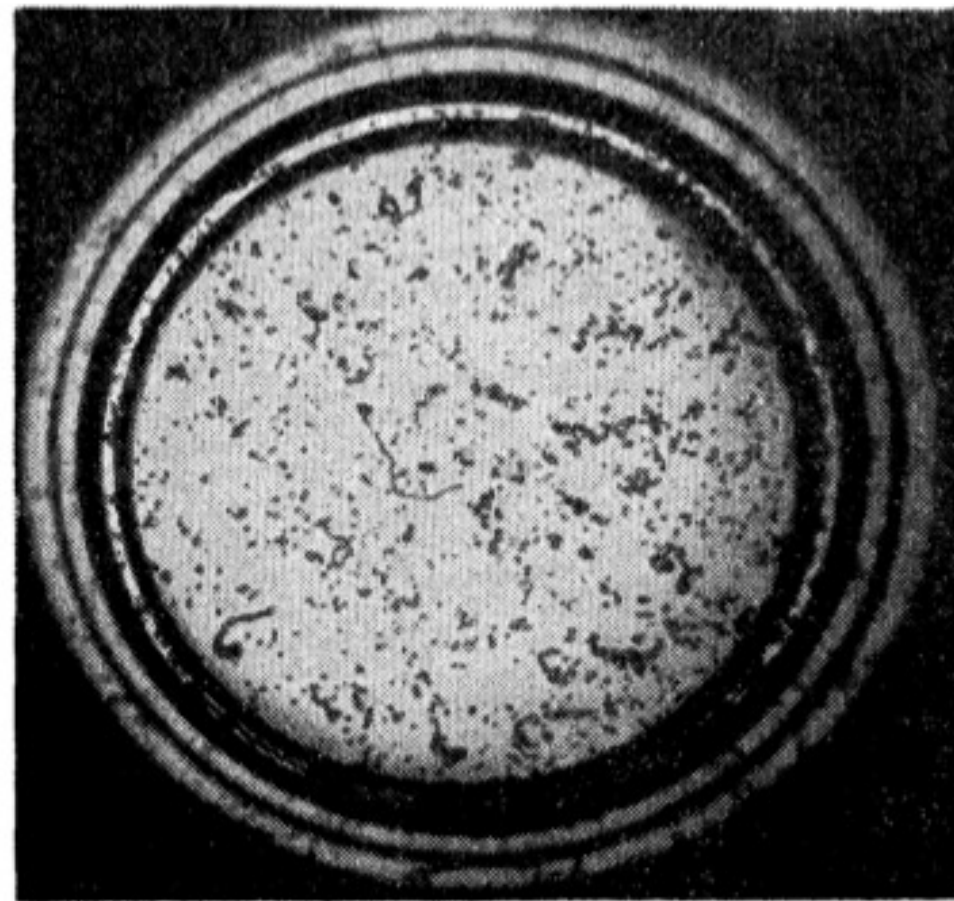

Phys. Rev. 102, 586 (1956)

- **The same technology can be used with a scintillating target to further eliminate backgrounds**
  - Noble liquids show little sensitivity to gammas when superheated

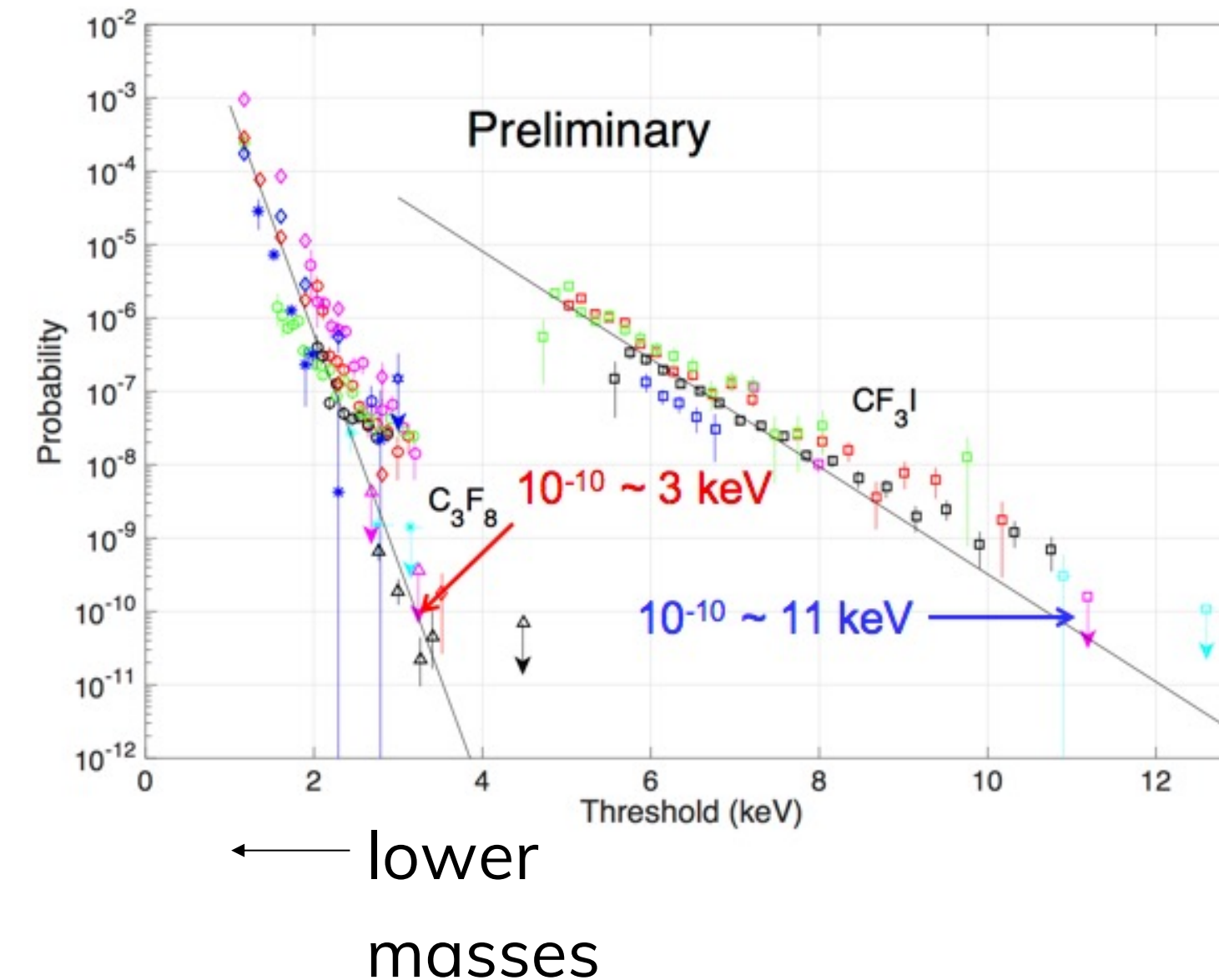

Courtesy of PICO Collaboration



# PICO 40L

Courtesy of PICO Collaboration

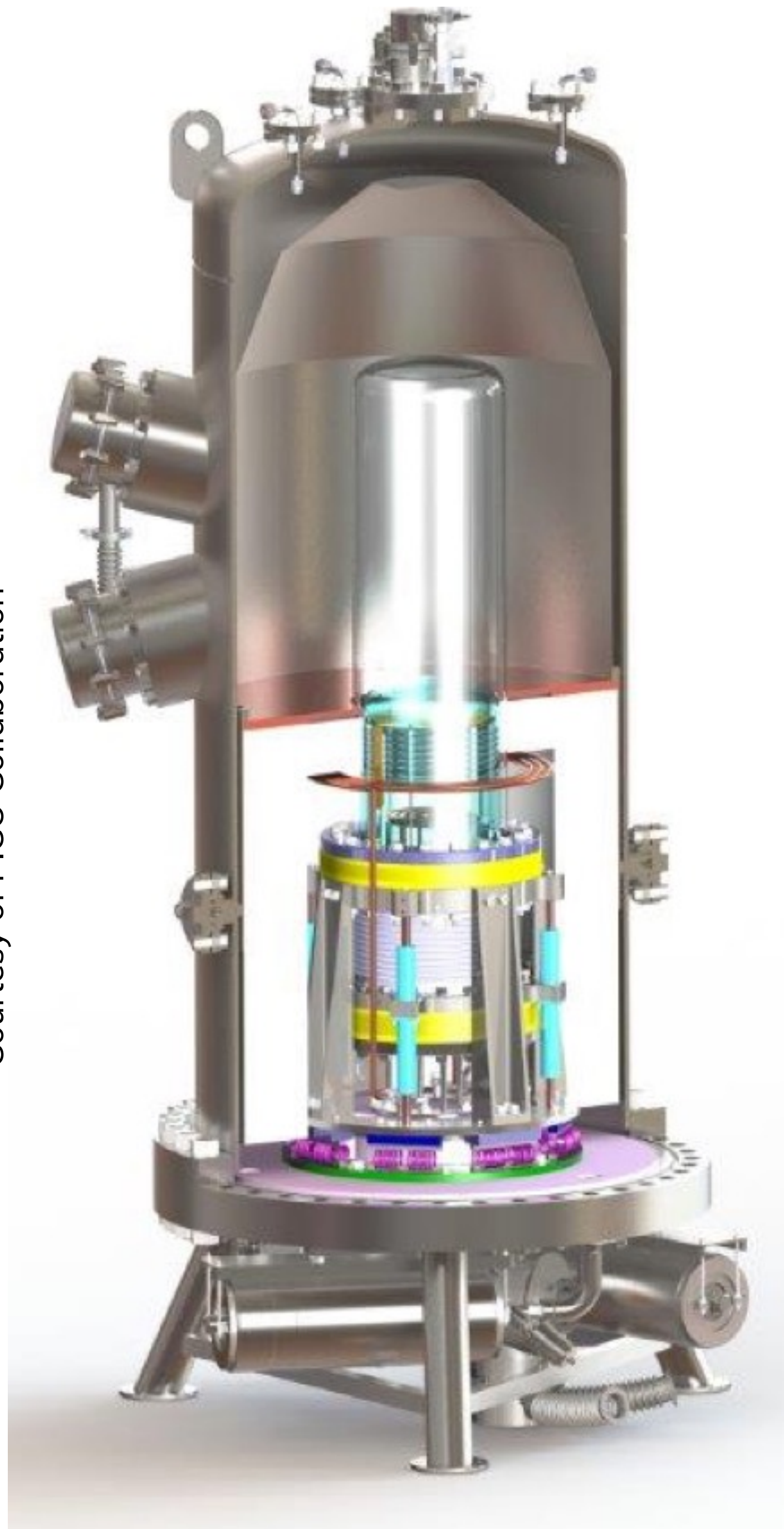

- PICO operates bubble chambers that are filled with a fluorine rich target fluid that gives PICO a world leading sensitivity to interactions between dark matter particles with spin and the detector
- Bubble chambers can be operated so that electron recoil events are not causing an event
- PICO chambers offer the ability to distinguish between the remaining background events and dark matter interactions
- PICO 40L is a large bubble chamber with a new chamber design that optimizes the sensitivity to ultimately allow a 10 times increased sensitivity compared to the previous version of PICO chambers.

# PICO 500

Courtesy of PICO Collaboration

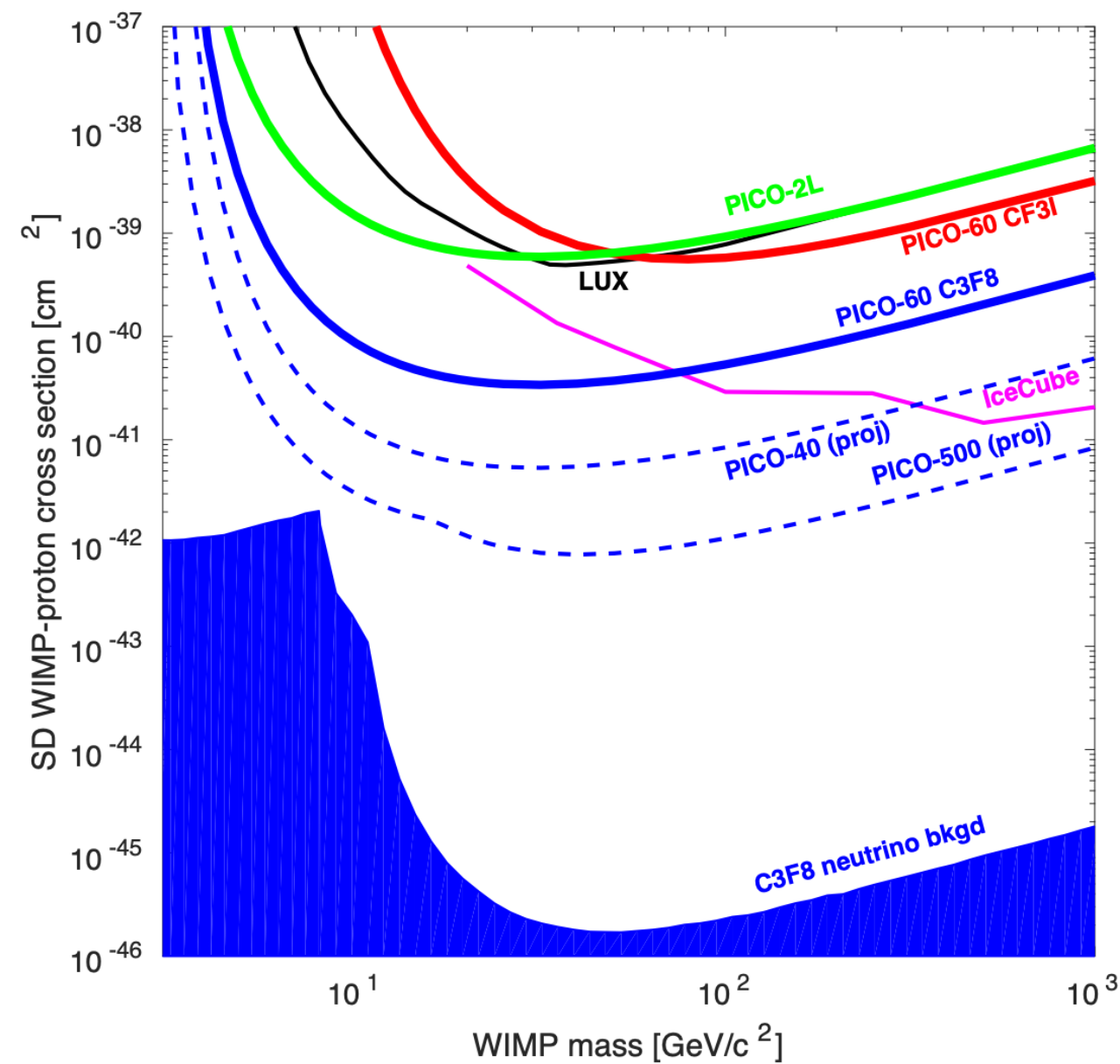
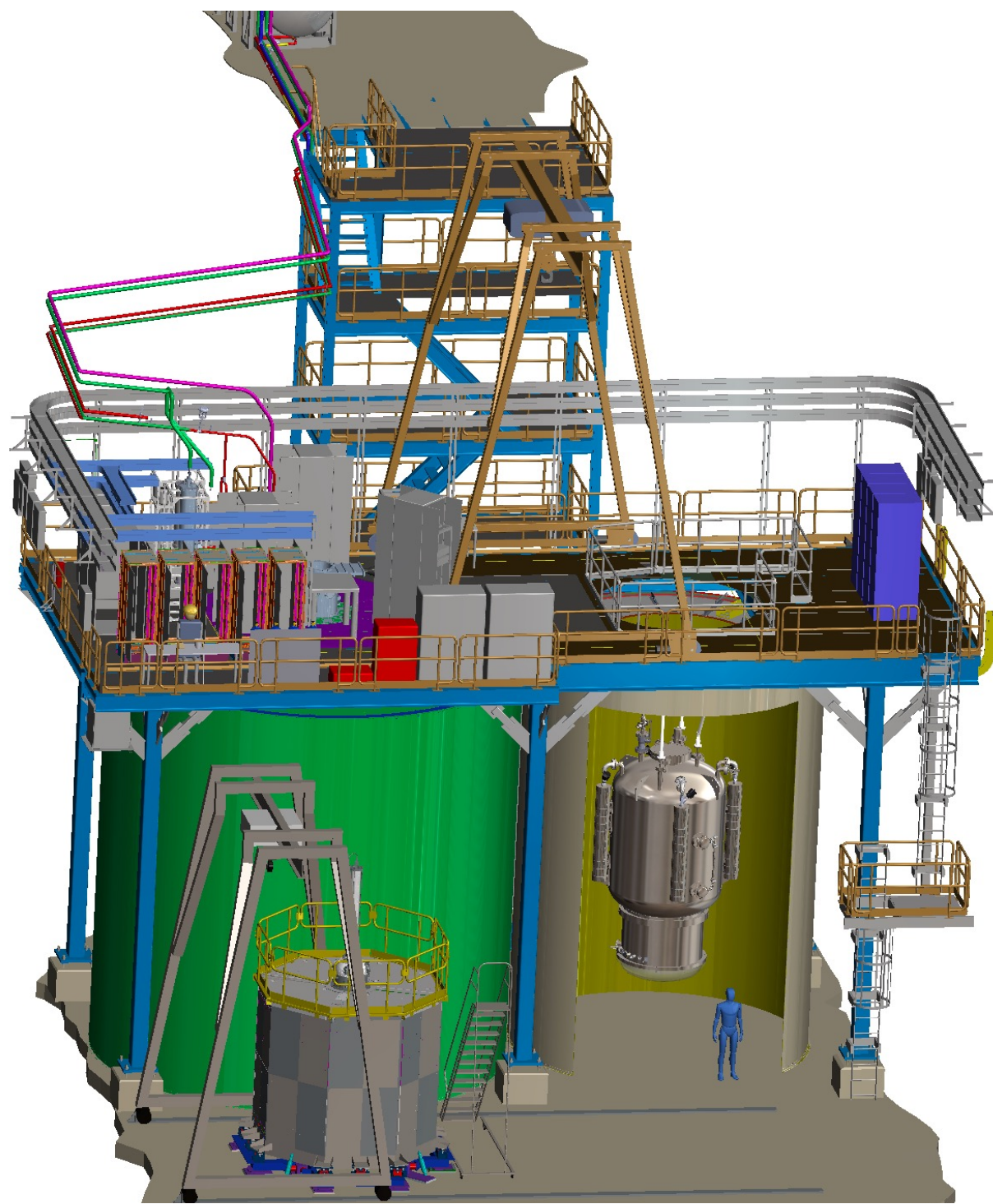

- PICO 500 is a larger bubble chamber using the same principle as PICO 40L that will be built in 2022 and 2023 at SNOLAB
- This chamber pushes the limit of our current ability to build and operate low background bubble chambers
- We predict another factor of 10 in increased sensitivity to spin-dependent dark matter couplings



# The Scintillating Bubble Chamber detector

- Conceptually a bubble chamber inside a cryostat
  - Silicon photomultipliers (SiPMs) added for scintillation light collection
  - Argon used as the target with xenon added to shift the wavelength
  - Cameras, piezos, recompression system very similar to the PICO-style detector
- The pressure vessel is currently being constructed, the internals are being finalized, and the SiPMs are being studied

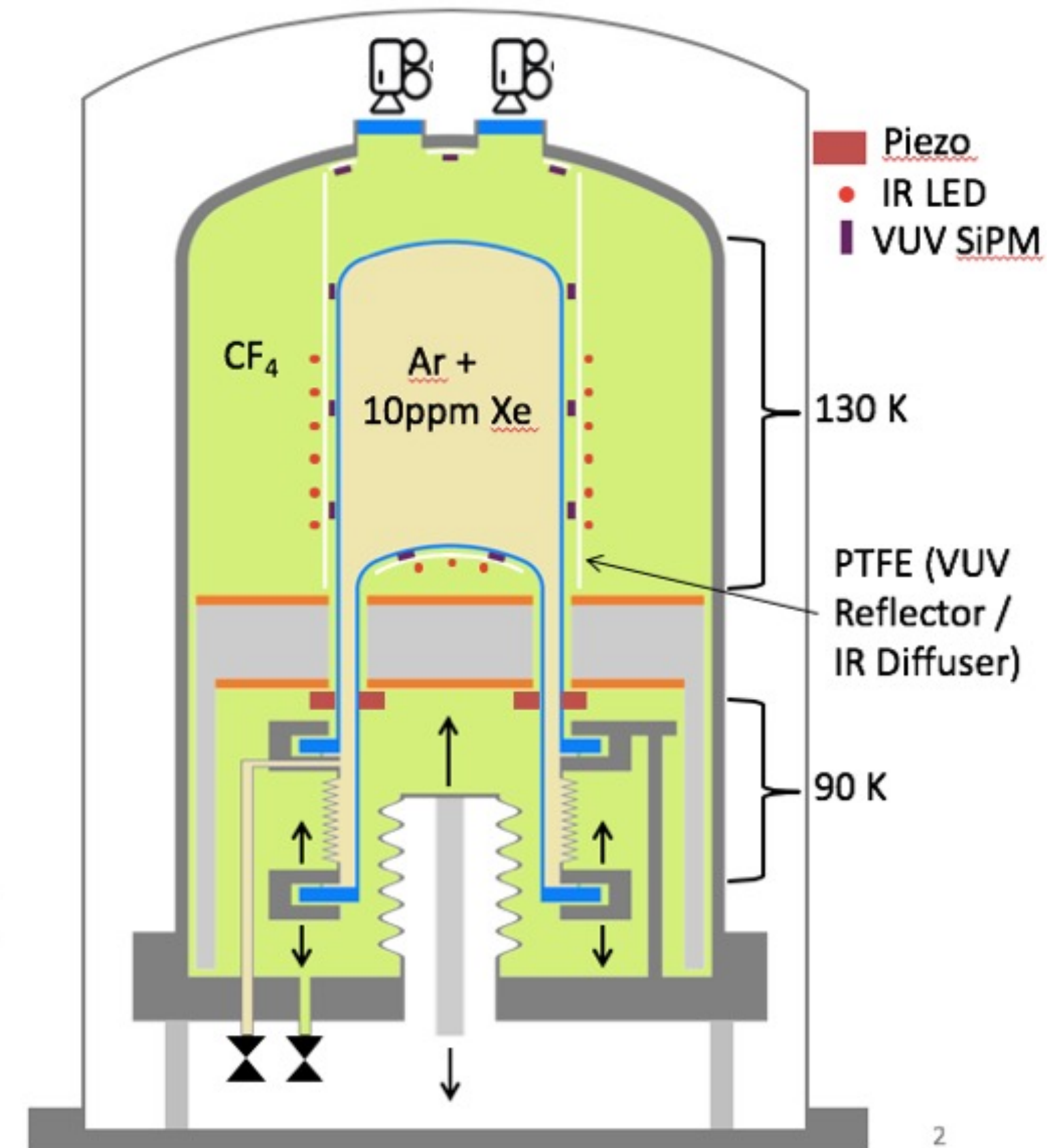

Courtesy of SBC Collaboration



# DEAP-3600 Construction

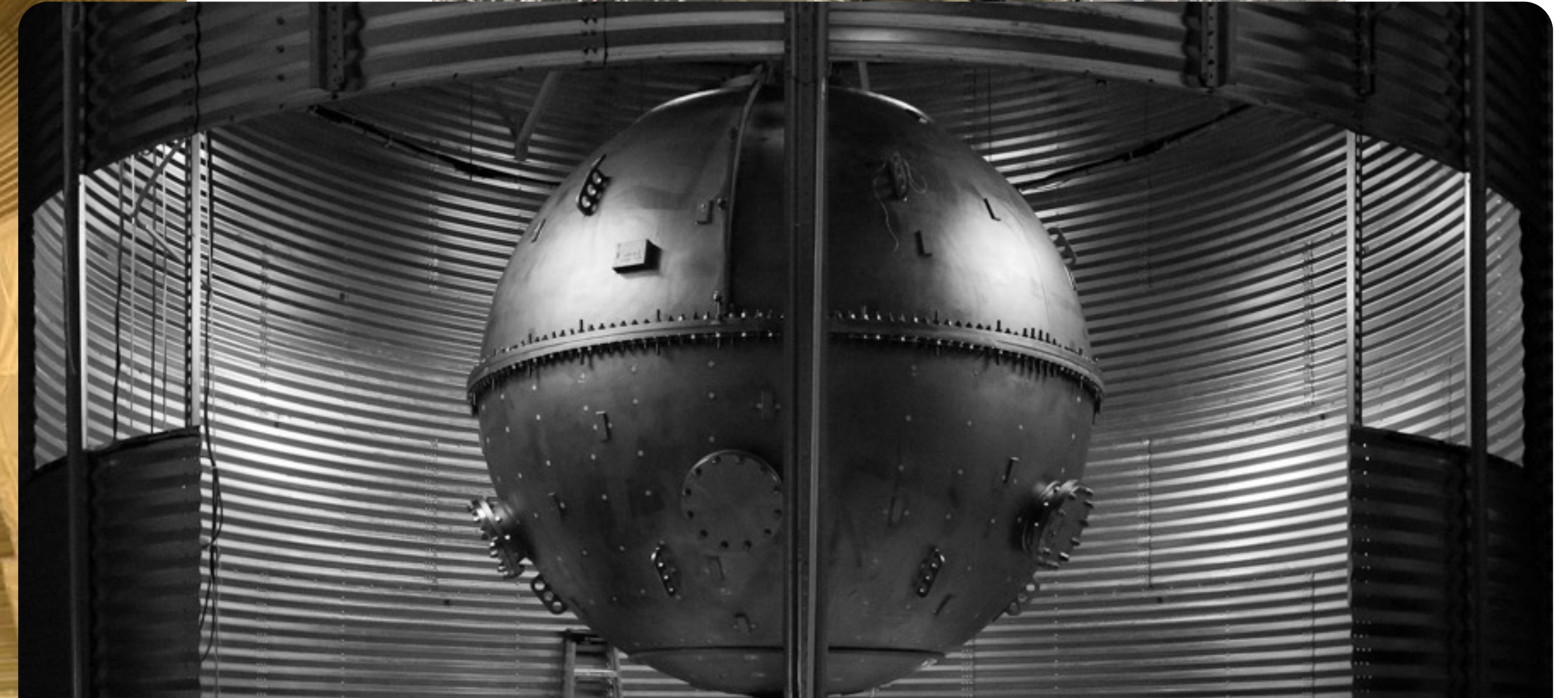
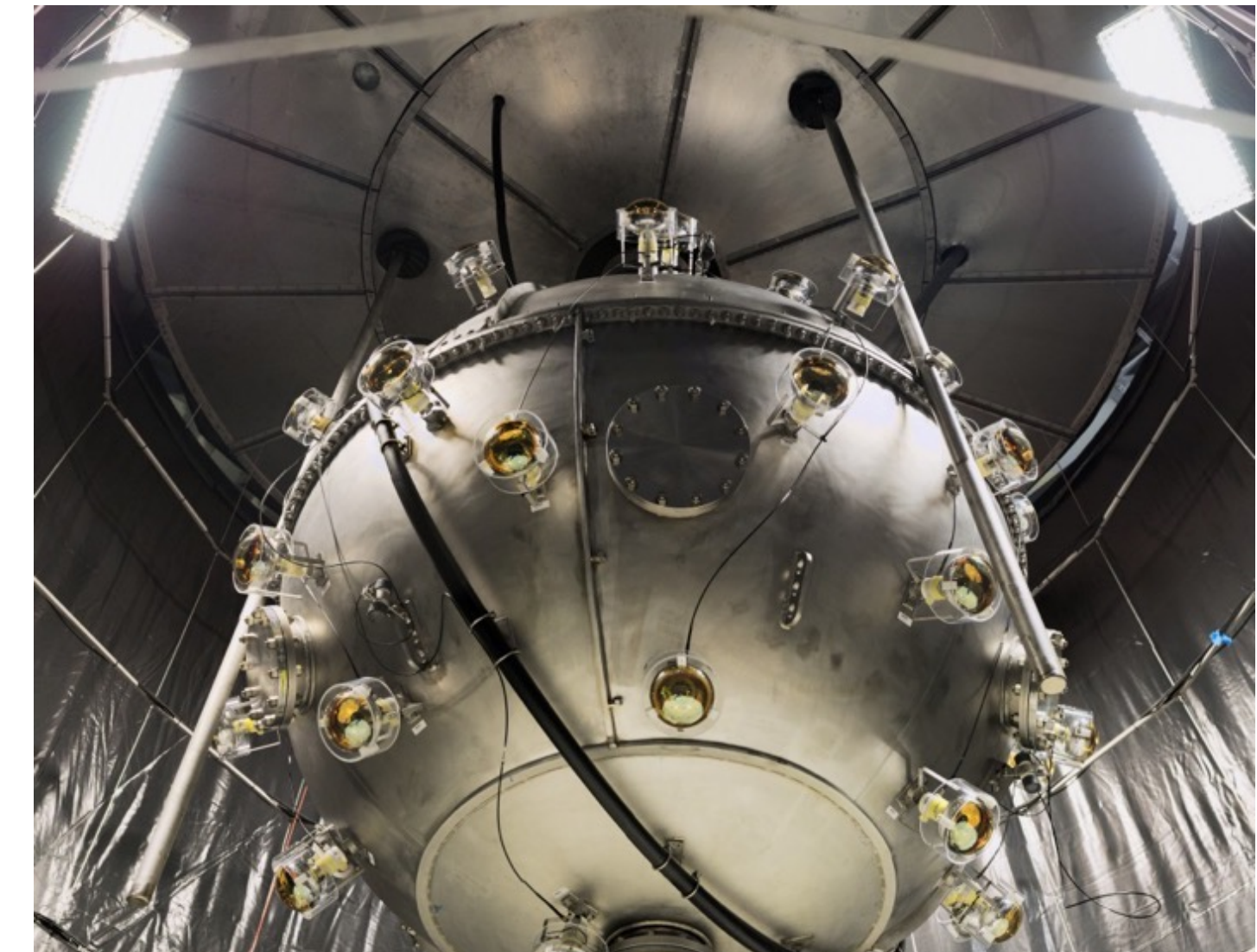
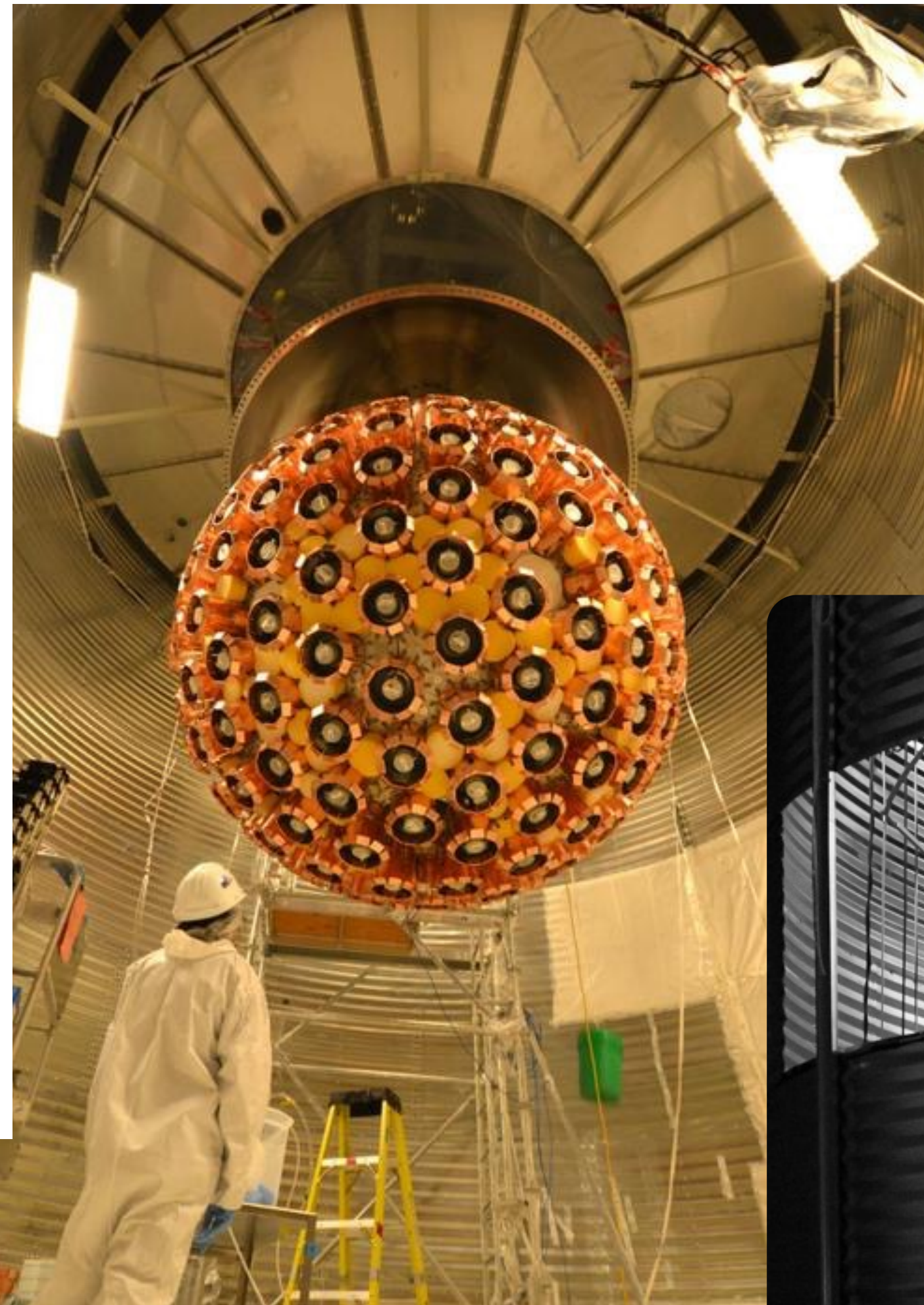
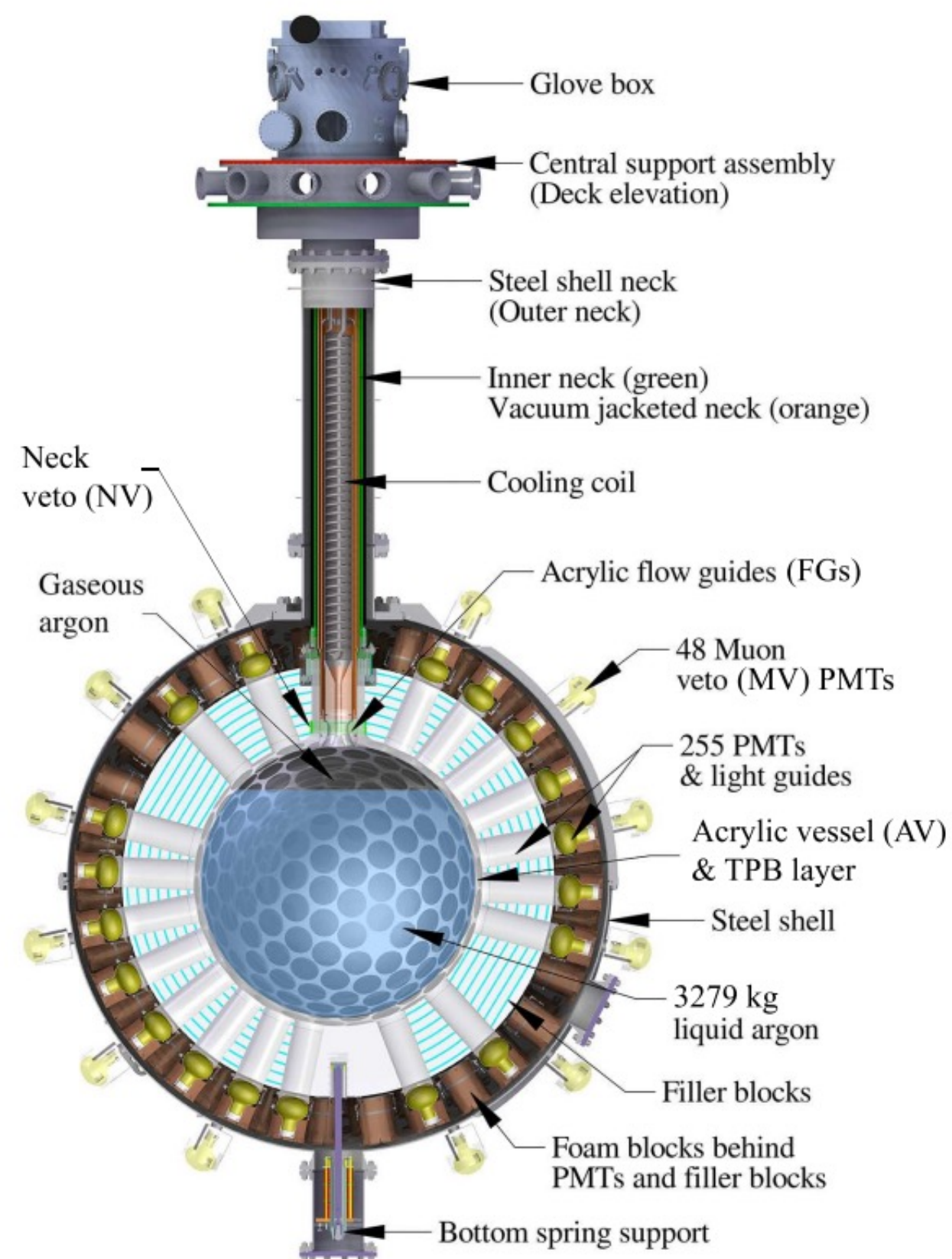



# DEAP-3600 Data

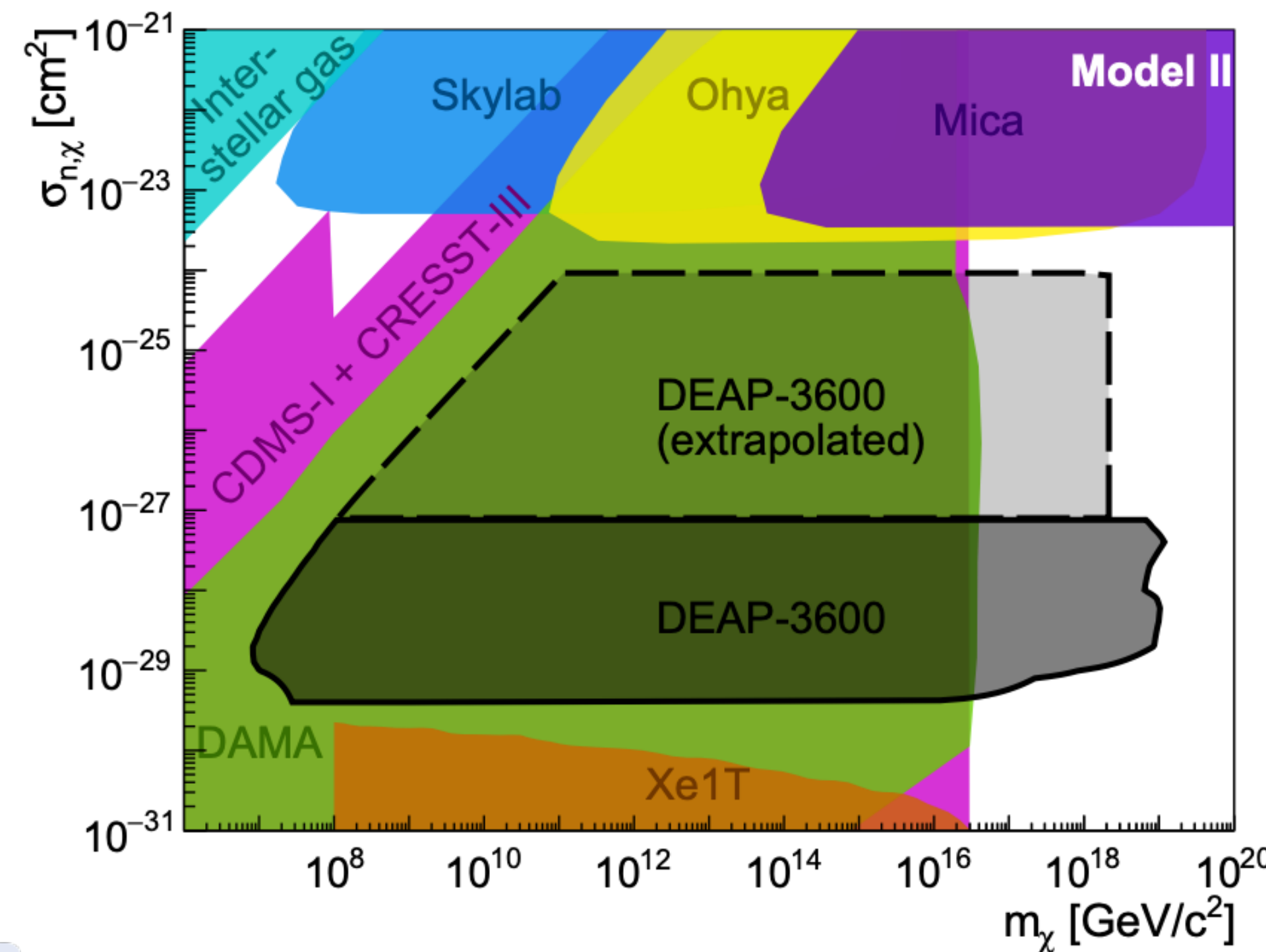
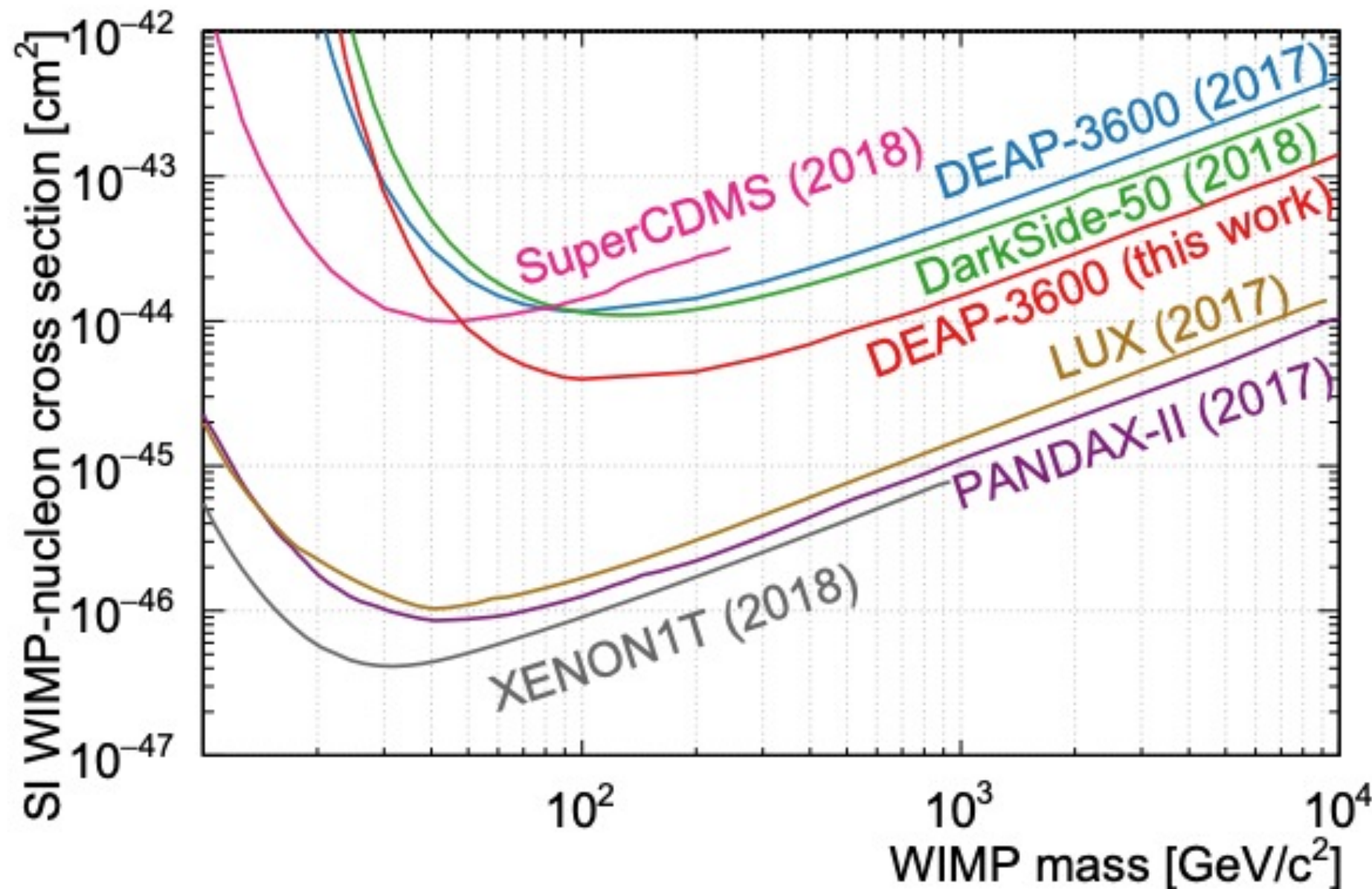
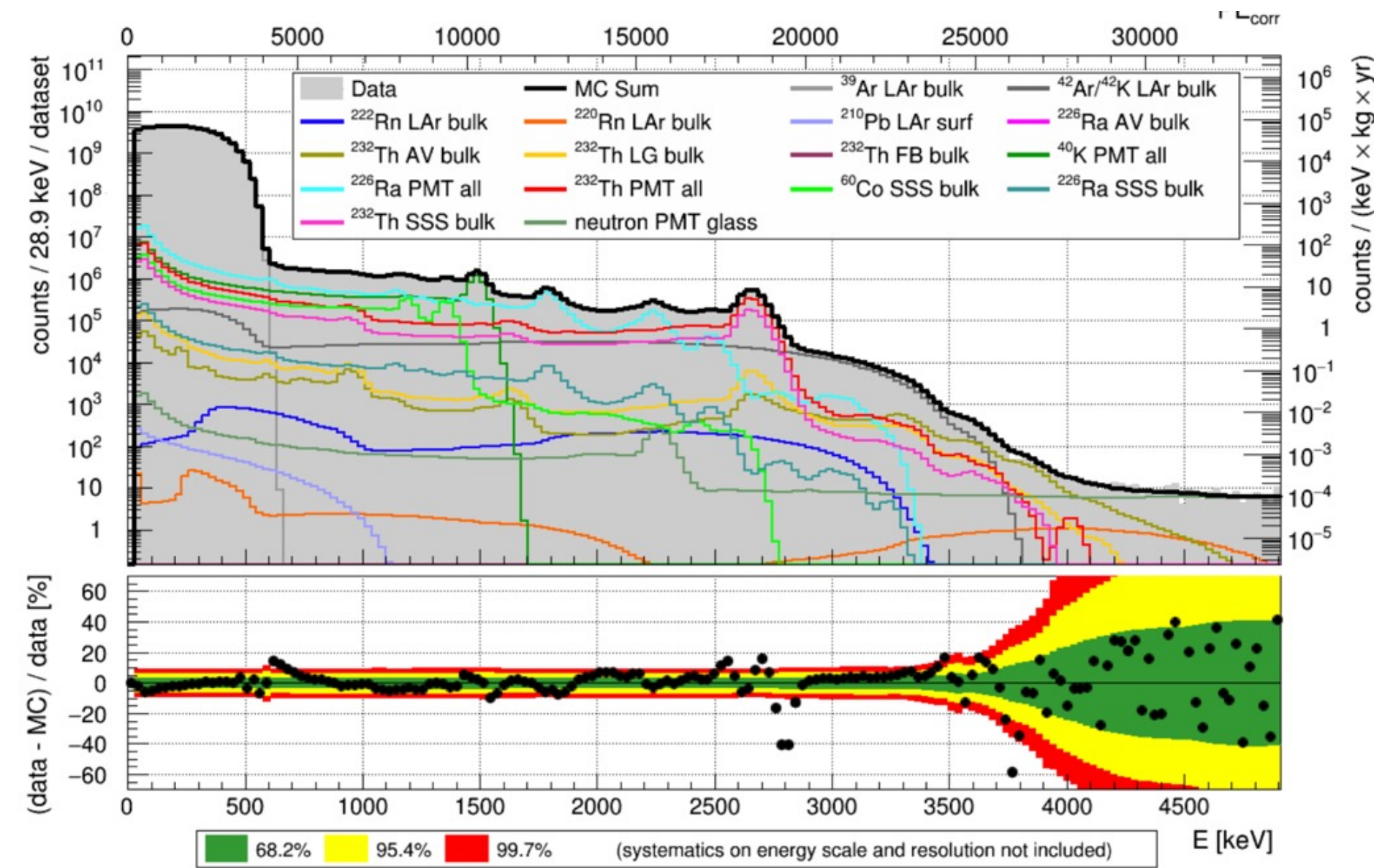



# DAMIC: Dark Matter in CCDs

- Pixelated charge readout.
- $<2 e^-$  of noise per pixel.
- Seven-CCD 40-gram detector operating at SNOLAB.
- Low background environment: radiopure components + shielding.
- Searching for ionization signals from the interactions of dark matter (DM) particles and atoms.
- High spatial resolution for the identification and characterization of backgrounds.

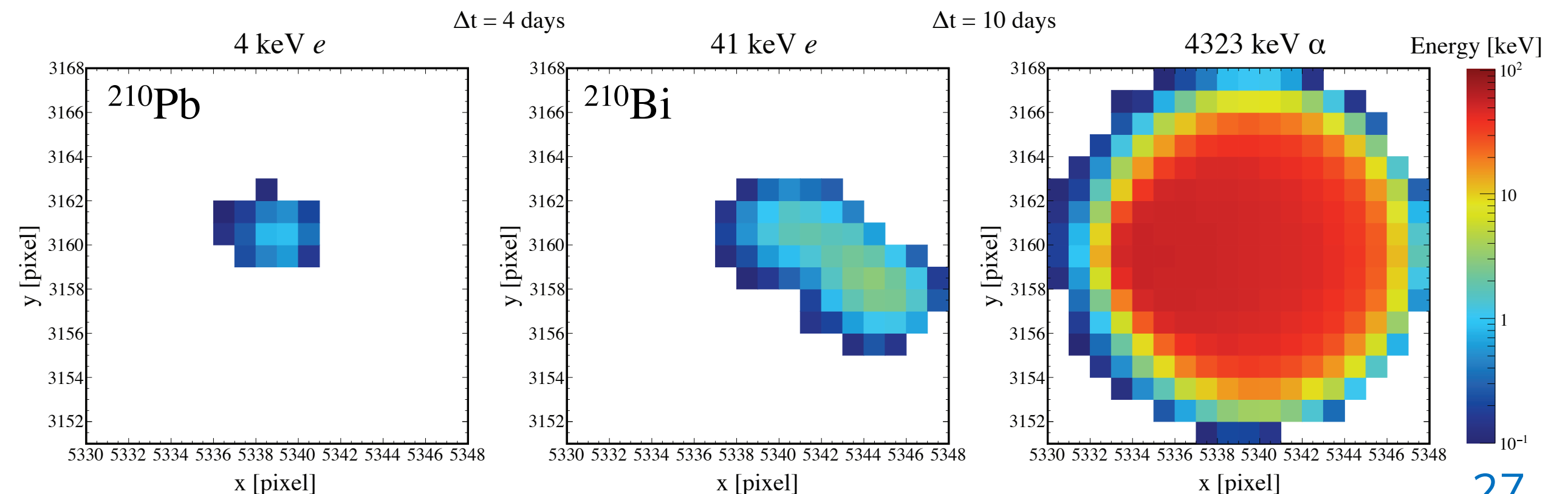
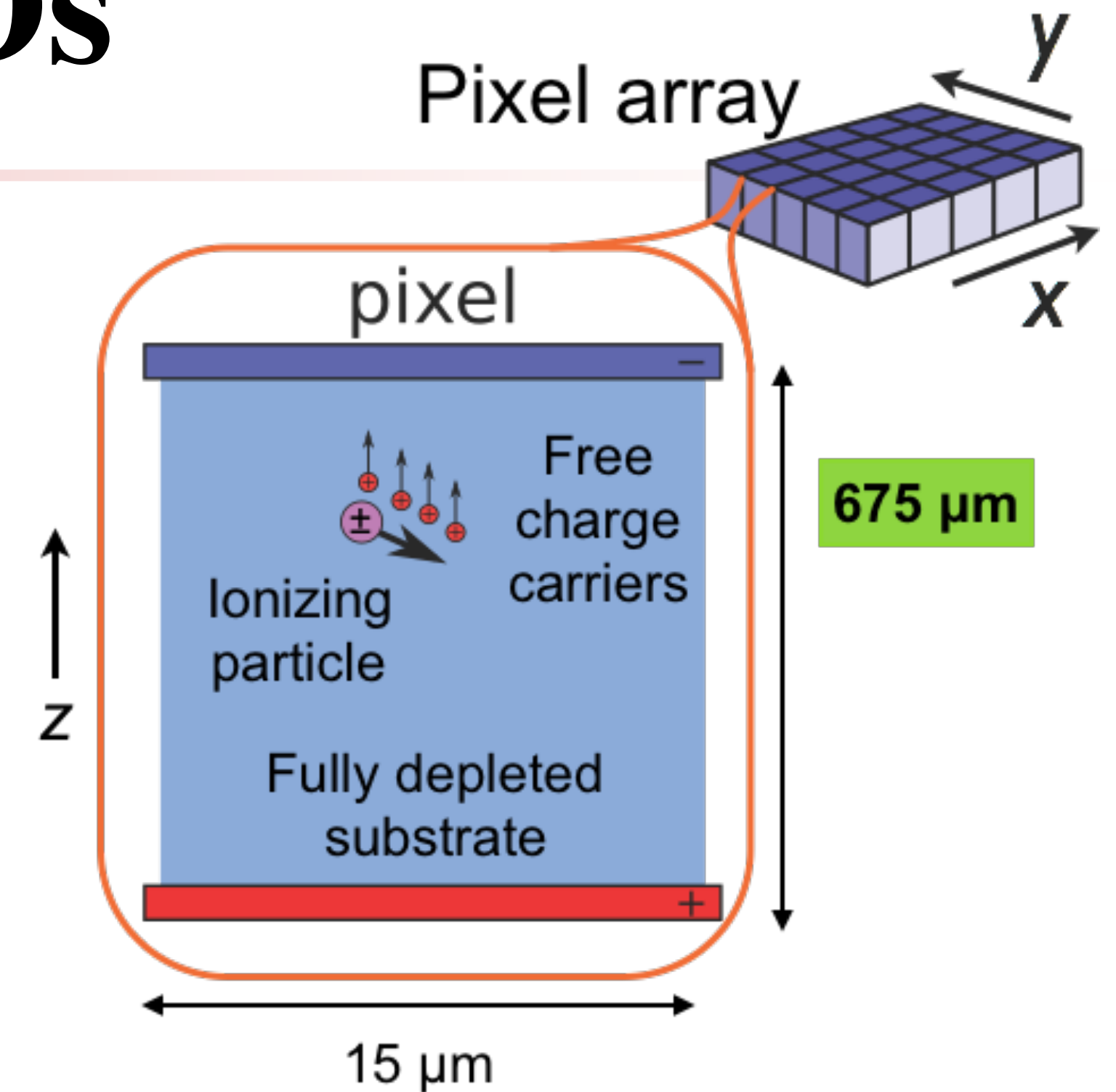
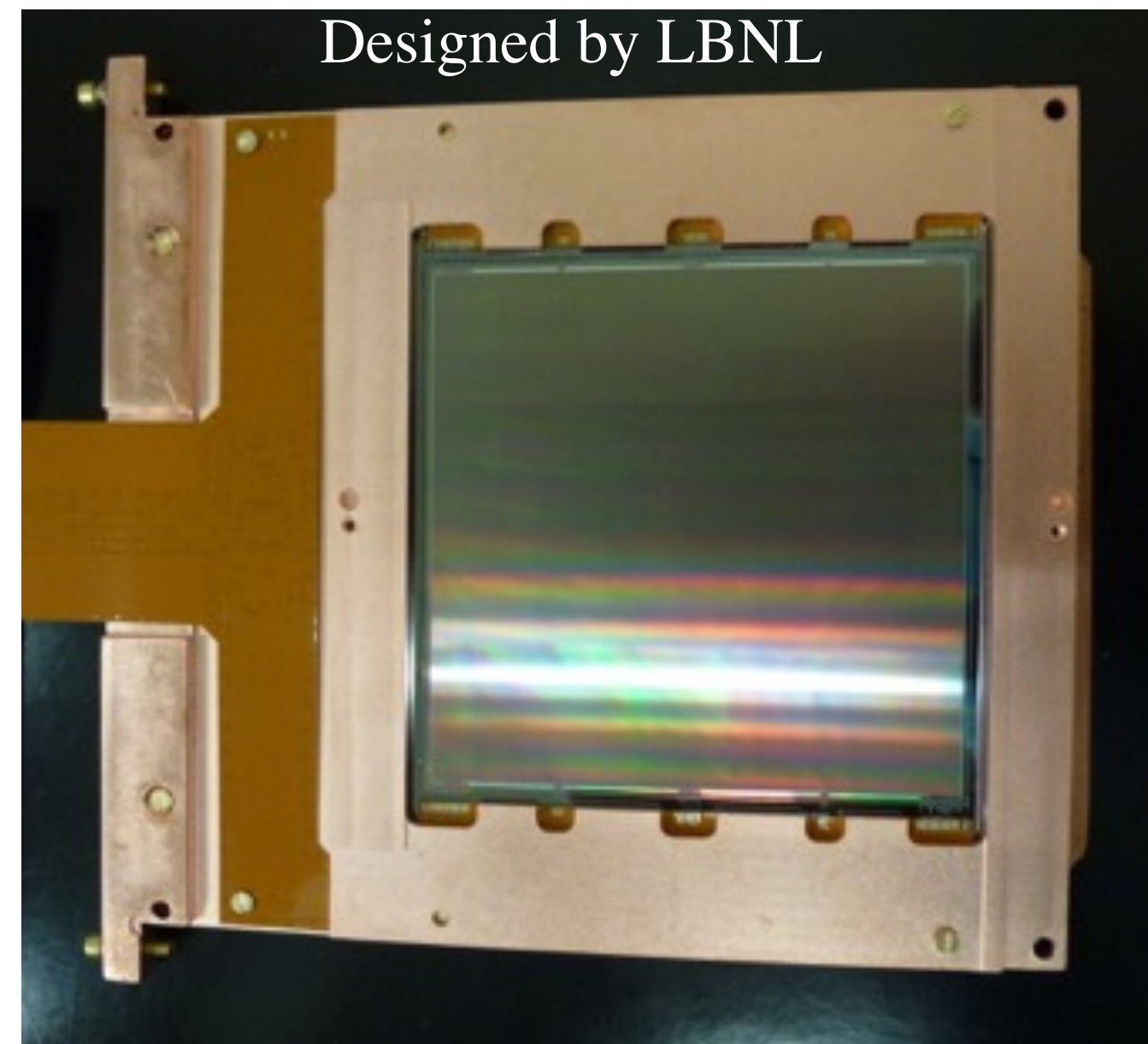



# Dark Matter Search Results

## DM-e<sup>-</sup> scattering Search PRL 123, 181802 (2019)

- Sensitivity to eV-scale signals possible because of extremely low leakage current.
- Search for deviations of observed pixel-value distribution from instrumental noise.

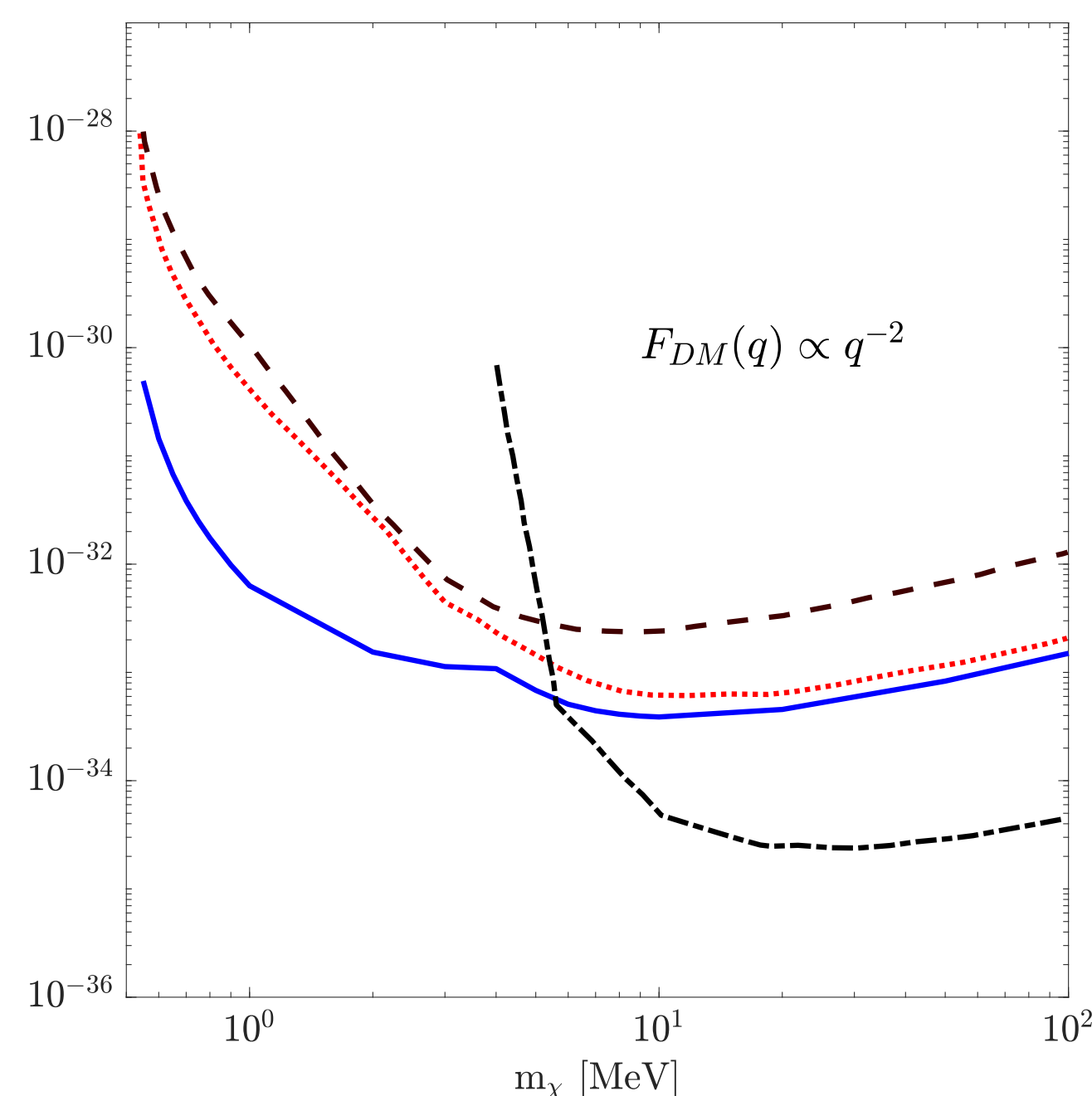
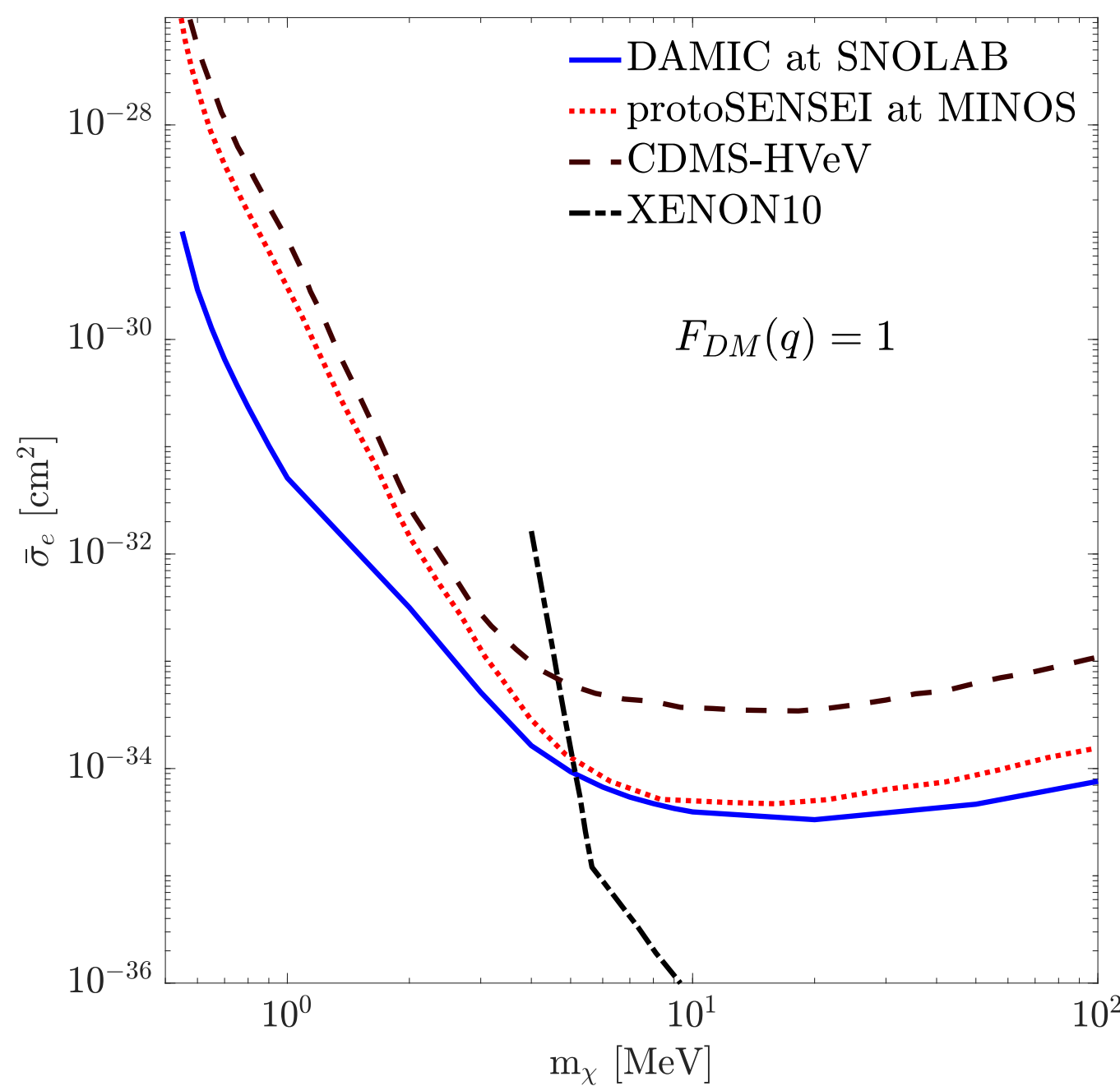

## WIMP Search PRL 125, 241803 (2020)

- 11 kg-day of data from seven-CCD array.
- Background model from all known radioactive contaminants matches data  $>200$  eV<sub>ee</sub>.
- Excess of events observed above 50 eV<sub>ee</sub> threshold.

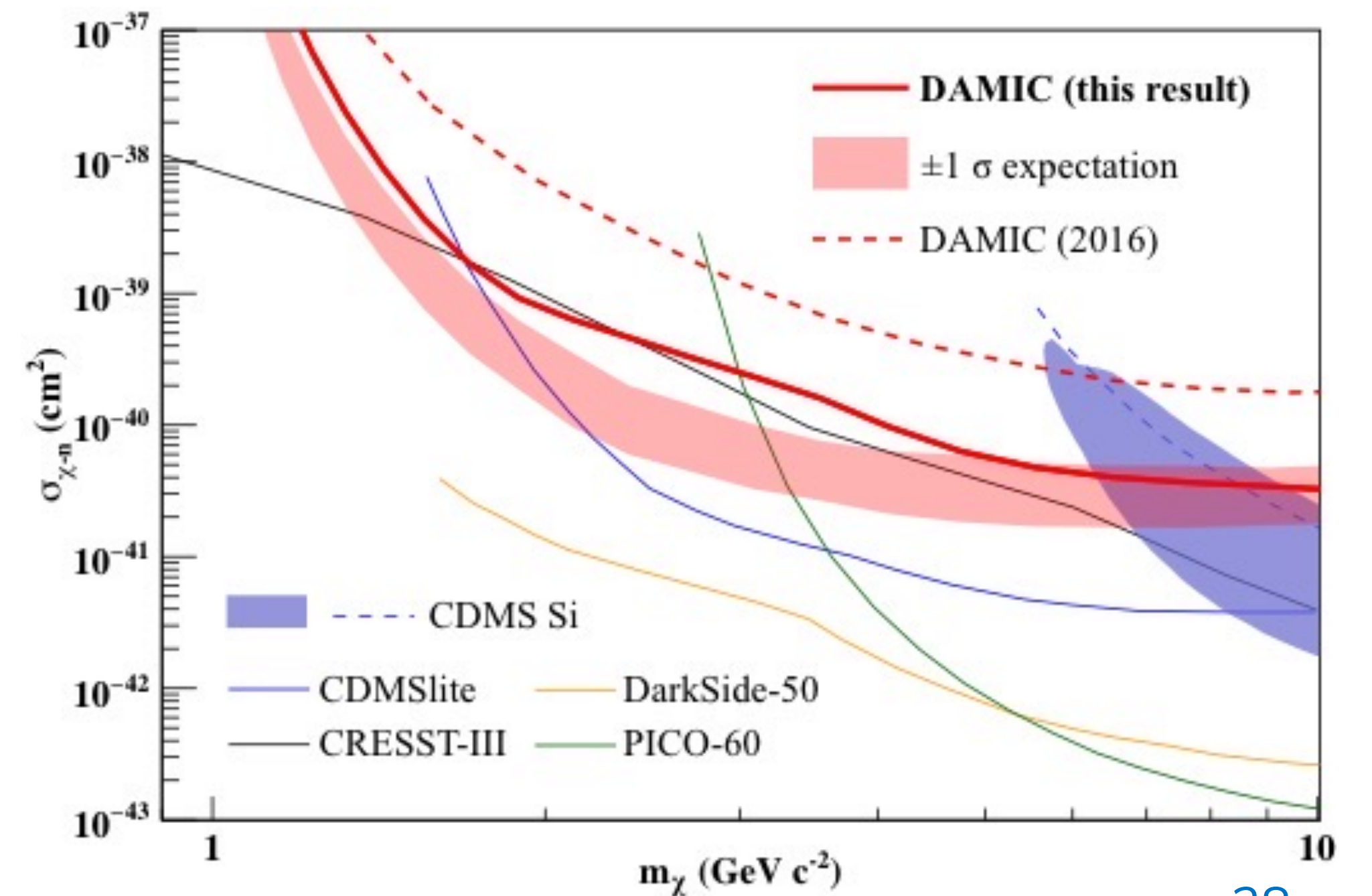



# Status of SENSEI

- **SNOLAB is now a full member of SENSEI (Ian, Silvia & Steffon)**
- **Joint team from SNOLAB and Fermilab fixed an electronic noise issue that was limiting the data quality (July-2022)**
- **Currently taking science-grade data**

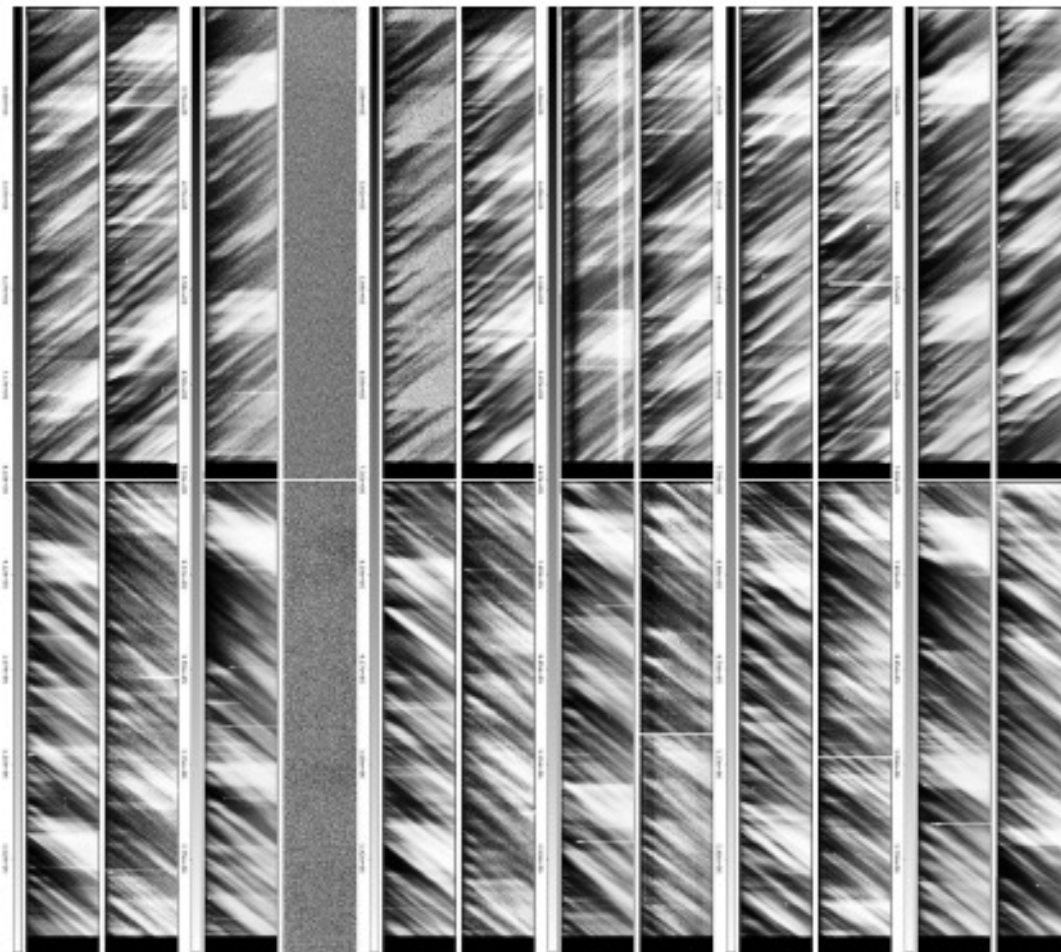

First light images (Nov-2021)



Fixing the electronic noise (Jul-2022)

## Science results

- SENSEI holds the best sensitivity for light DM candidates since 2020  
arXiv:2004.11378
- New paper on Single Electron Events published in 2022  
arXiv:2106.08347

Courtesy of SENSEI Collaboration



# Oscura

## Oscura Project Overview

Dark matter search with skipper-CCD in a total exposure of **30 kg-year**.

- Technology : **skipper-CCD**
- Timeline :
  - R&D FY20-FY22
  - Design FY23-FY24
  - Construction FY25-FY28

## Design: Overall

- **20,000 skipper-CCDs:**
  - 1.2 Mpix each
  - readout noise 0.15e-
  - 10 kg active mass
- **20,000 readout channels:**
  - cold front end electronics
  - cold analog multiplexing
  - warm backend
- **1500 Multi Chip Modules (MCM)**
  - 16 CCDs mounted
  - Silicon substrate
  - low background flex
- **100 Super Modules (SM)**
  - 16 MCM on each
  - 130 g of active mass
- **Pressure vessel**
  - LN2 vessel @ 450 psi
  - internal copper and lead shield
- **Outside shield**
  - lead for gammas
  - poly/water for neutrons
- **Background**
  - Operated underground (SNOLAB)
  - 0.01 DRU

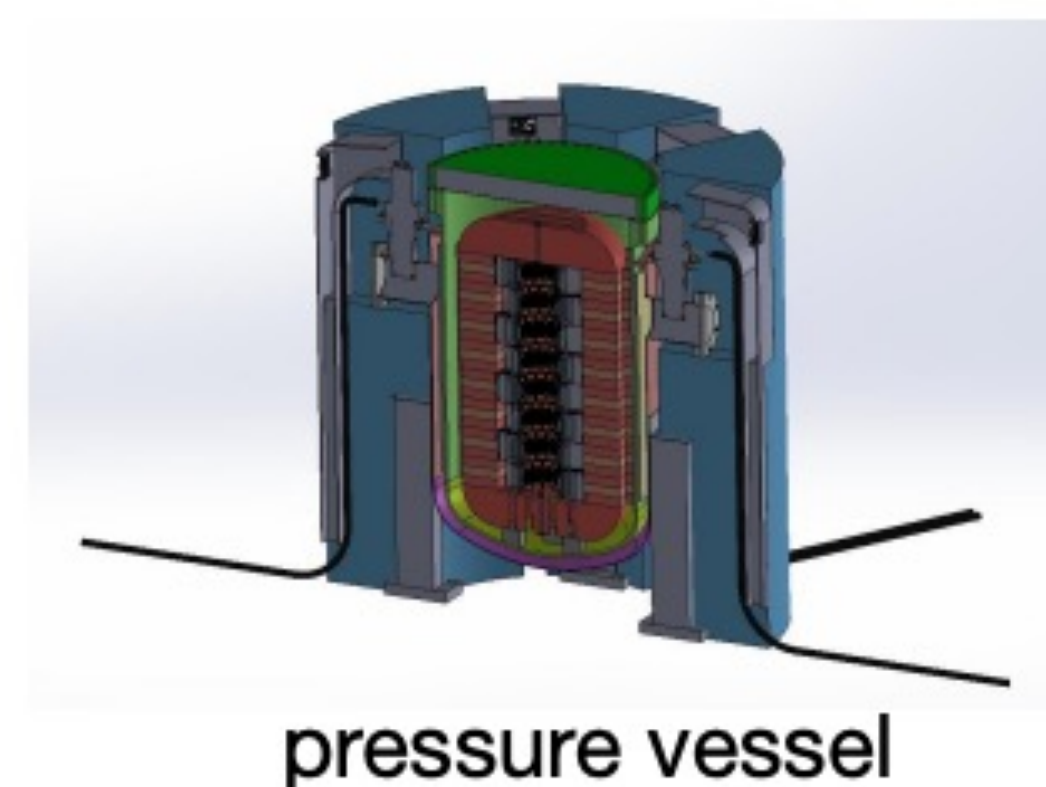
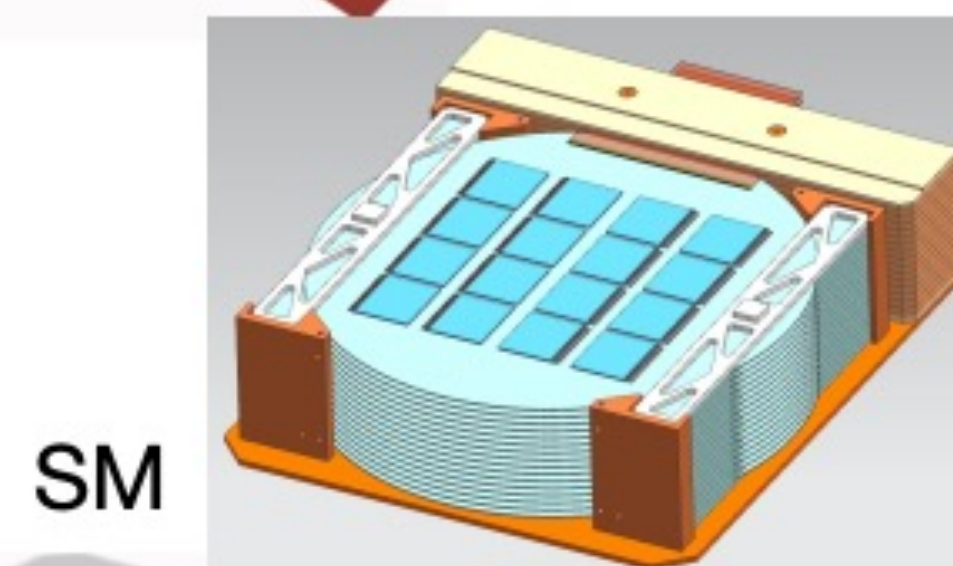
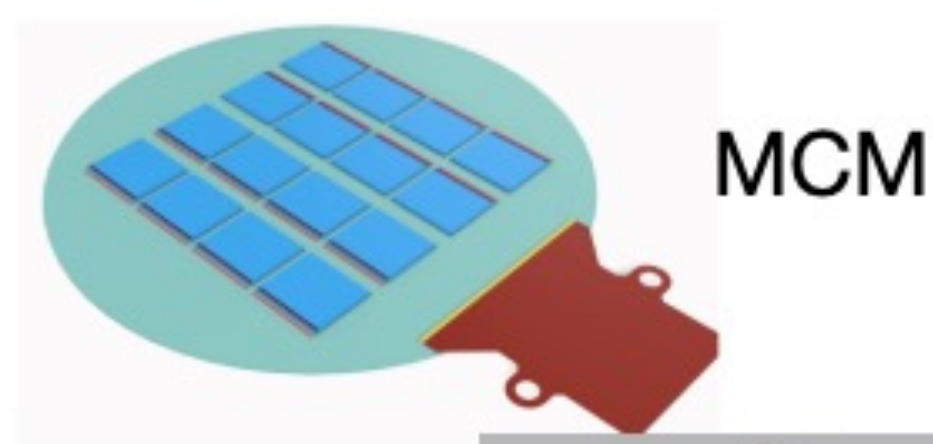

Courtesy of Oscura Collaboration



# NEWS-G Project Goals

- The goal of the NEWS-G project is to search for WIMPS at masses as low as  $0.1 \text{ GeV}/c^2$ .
- This is achieved by using light gases (Ne, He,  $\text{CH}_4$ ) as a target material in a Spherical Proportional Counter (SPC) which allows to reach very low thresholds
- The SPC is made of a high purity copper sphere (C10100 copper electroplated with  $500\mu\text{m}$  of pure copper)
- The SPC is installed in a compact shield of 3cm roman lead, 25cm low activity lead and 40cm HDPE, installed at the Cube Hall in SNOLAB

Courtesy of NEWS-G Collaboration

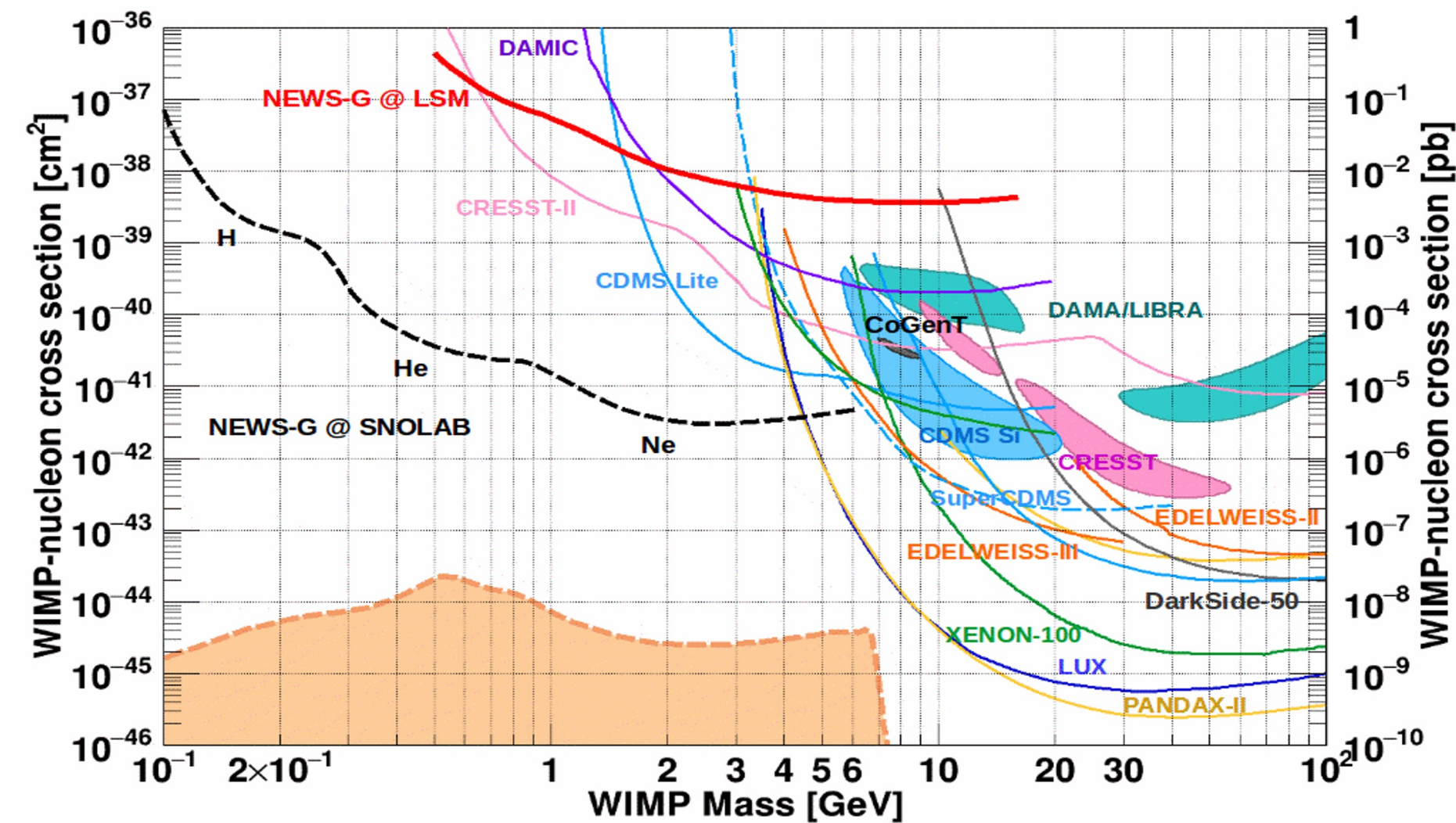



## NEWS-G Project Status

- The NEWS-G installation in the Cube Hall is completed
- The copper sphere was etched to remove possible internal surface contamination
- Operation Readiness Review completed 22 July 2021
- First signal in argon August 10th
- Commissioning ongoing
- Stable, high-gain, and low electronic noise data taking demonstrated in July 2022
- Now getting ready for a physics run with a neon-methane mixture



Courtesy of NEWS-G Collaboration

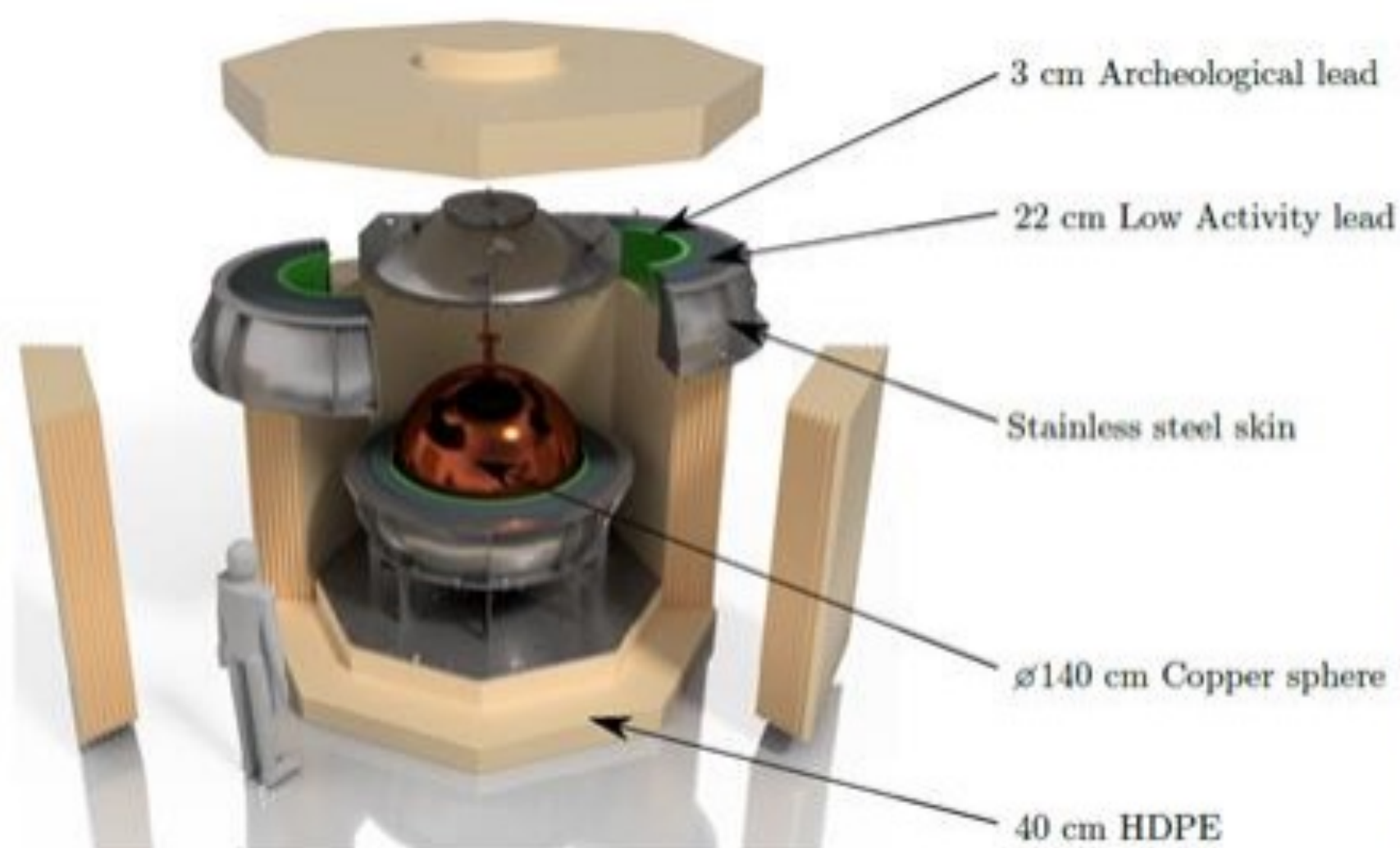



# SuperCDMS Strategy: Complementary Targets and Multiple Functionality



	Germanium	Silicon
HV	<p><b>Lowest threshold for low mass DM</b></p> <p><b>Larger exposure, no <math>^{32}\text{Si}</math> bkgd</b></p>	<p><b>Lowest threshold for low mass DM</b></p> <p><b>Sensitive to lowest DM masses</b></p>
iZIP	<p><b>Nuclear Recoil Discrimination</b></p> <p><b>Understand Ge Backgrounds</b></p> <p><b>Sensitive to <math>^8\text{B}</math> <math>\nu</math>-scatter</b></p>	<p><b>Nuclear Recoil Discrimination</b></p> <p><b>Understand Si Backgrounds</b></p> <p><b>Sensitive to <math>^8\text{B}</math> <math>\nu</math>-scatter</b></p>

2 technologies and 2 target materials provide coverage of the low mass WIMP region, as well as sensitivity to electron-recoiling dark matter

## Two Types of Detectors

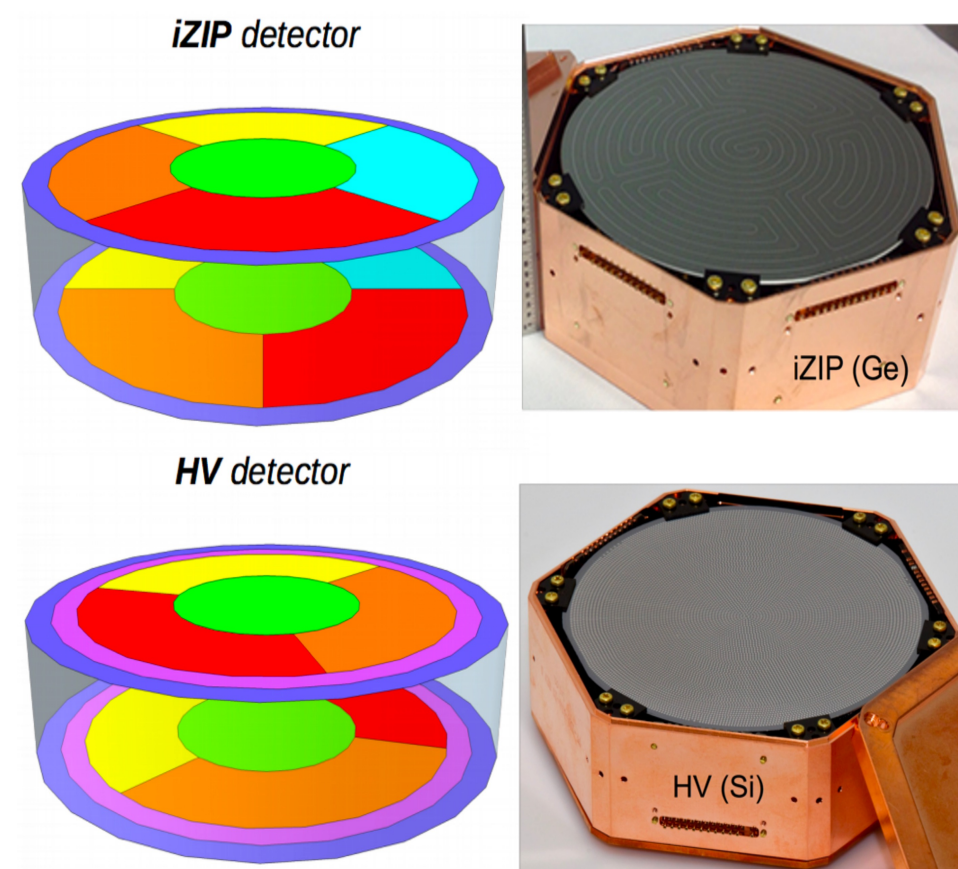

## Initial 4-tower payload

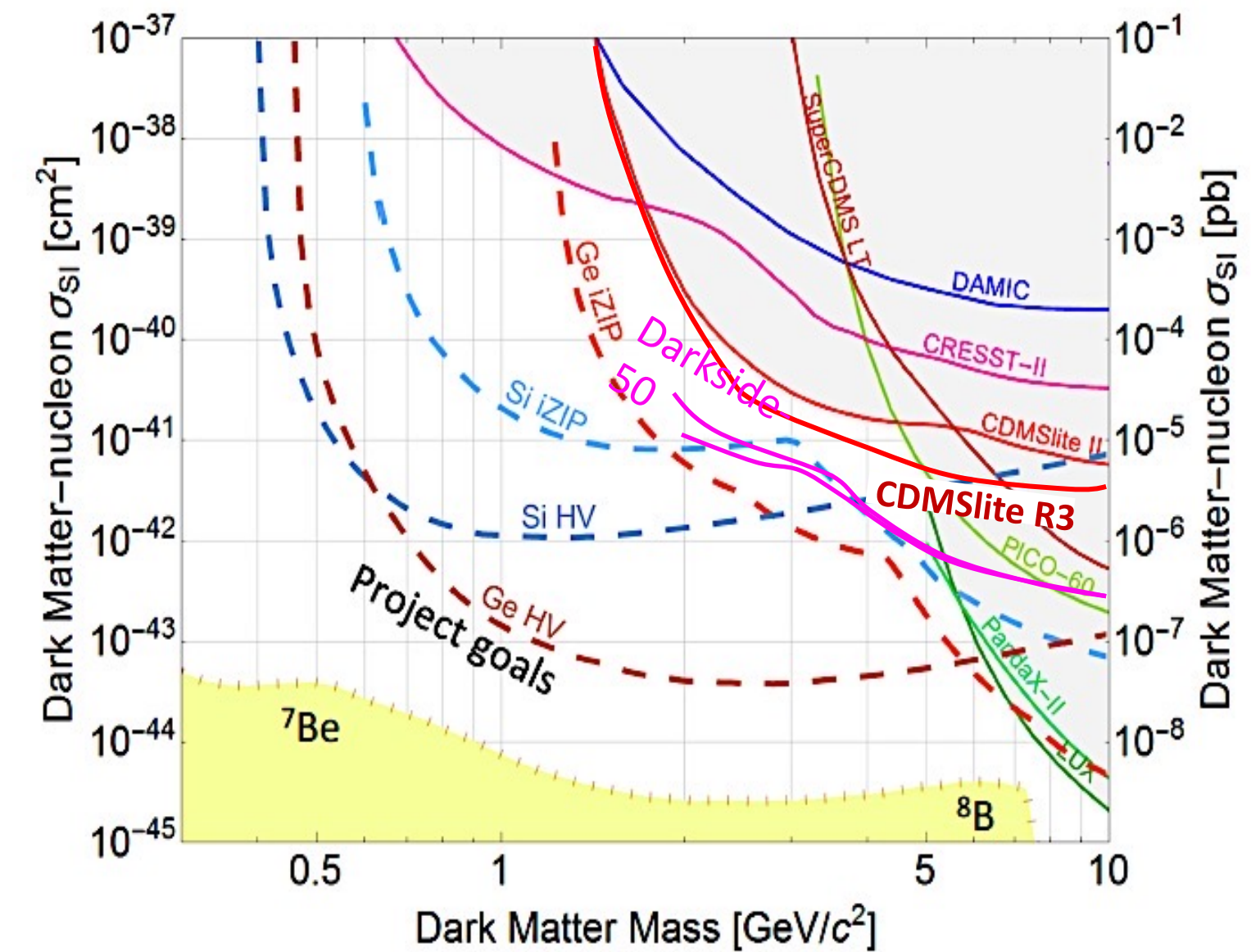
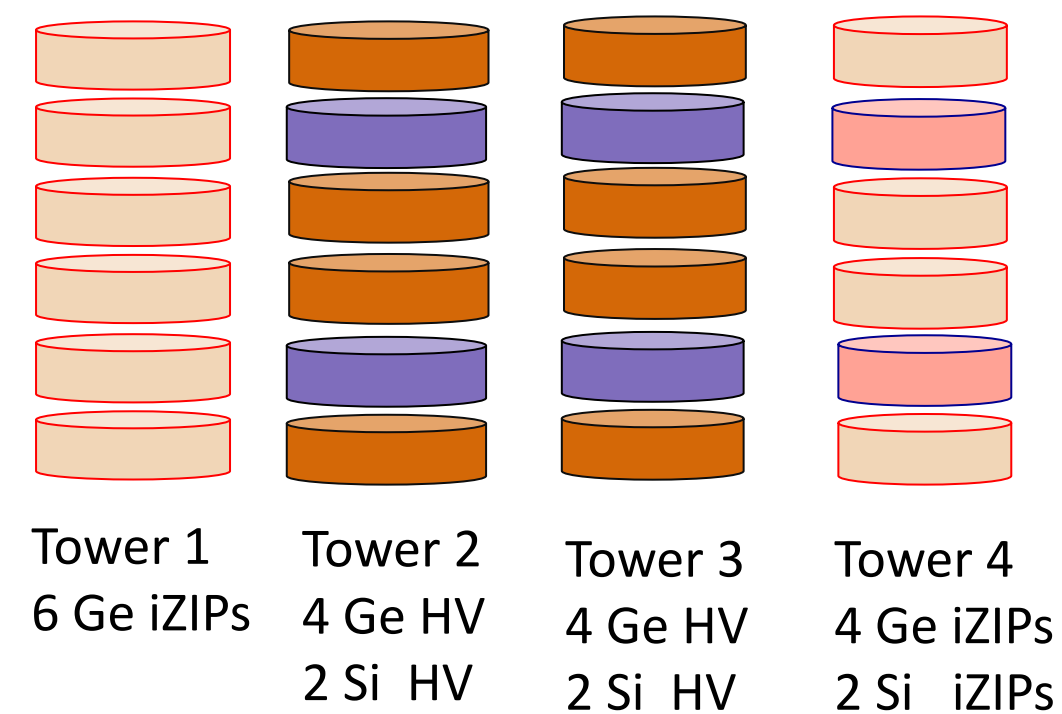

Courtesy of SuperCDMS Collaboration



## SuperCDMS SNOLAB infrastructure

Will provide a facility for world-leading, low-mass dark matter sensitivity down to the neutrino floor

Installation underway, expect detector commissioning in early 2024

First science results will use the CUTE test facility, located in the same lab as SuperCDMS

Small R&D detectors and prototype SuperCDMS detectors provide new science results 2021-2023

Full cryostat and cold 4-tower payload running by early 2024

## The initial SuperCDMS SNOLAB 4-tower payload will provide

An order of magnitude improvement WIMP limits for

$0.5 < M_{DM} < 5$  GeV with a sequence of two year-long runs

First paper will be HV Optimal Interval for 1 month of data,

Later papers will model bkgds  $\Rightarrow$  Profile Likelihood

## The low background shielded cryostat

can hold SuperCDMS upgrades or partner collaborations to reach the neutrino floor for low mass WIMPs

## New ER benchmark models $\Rightarrow$ New parameter space can be explored

Through 2022 with

- R&D detectors at NEXUS, CUTE, and surface test facilities

After 2023 with

- Early science at CUTE, prior to commissioning
- SuperCDMS SNOLAB 4-tower runs, SuperCDMS SNOLAB upgrades

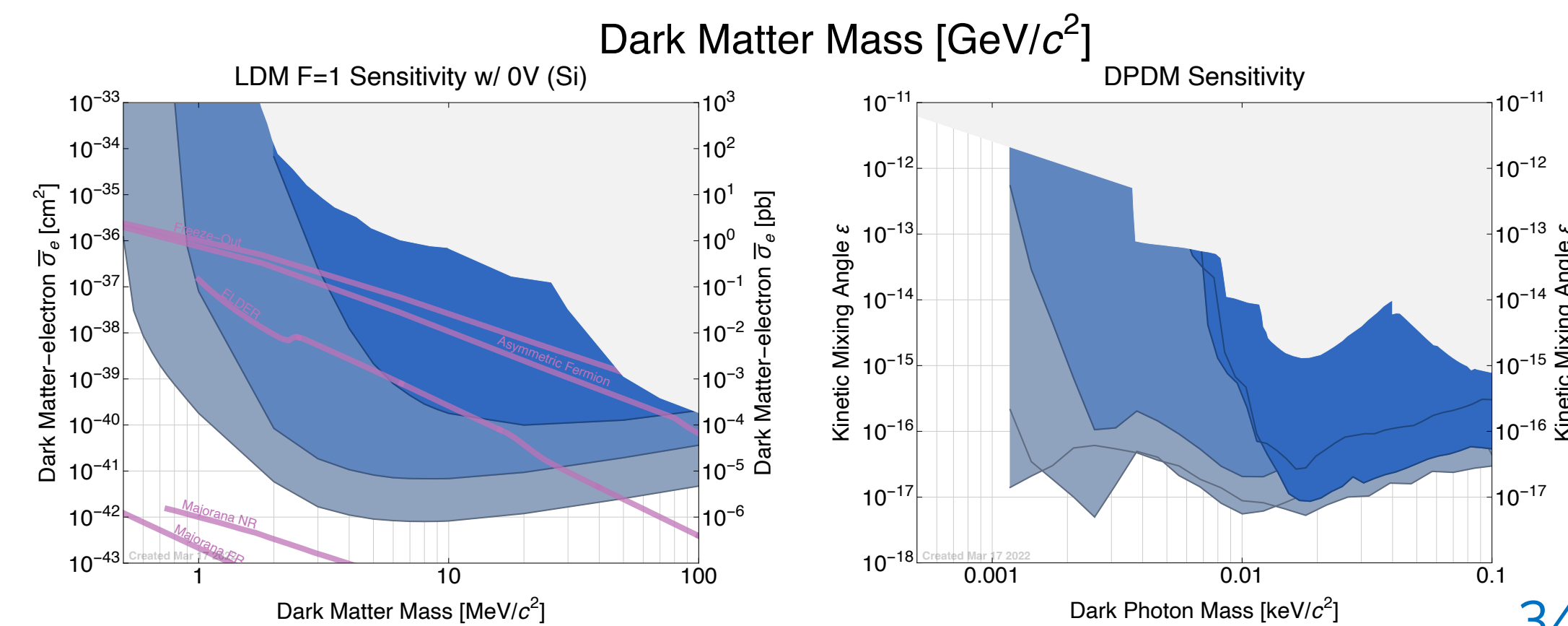
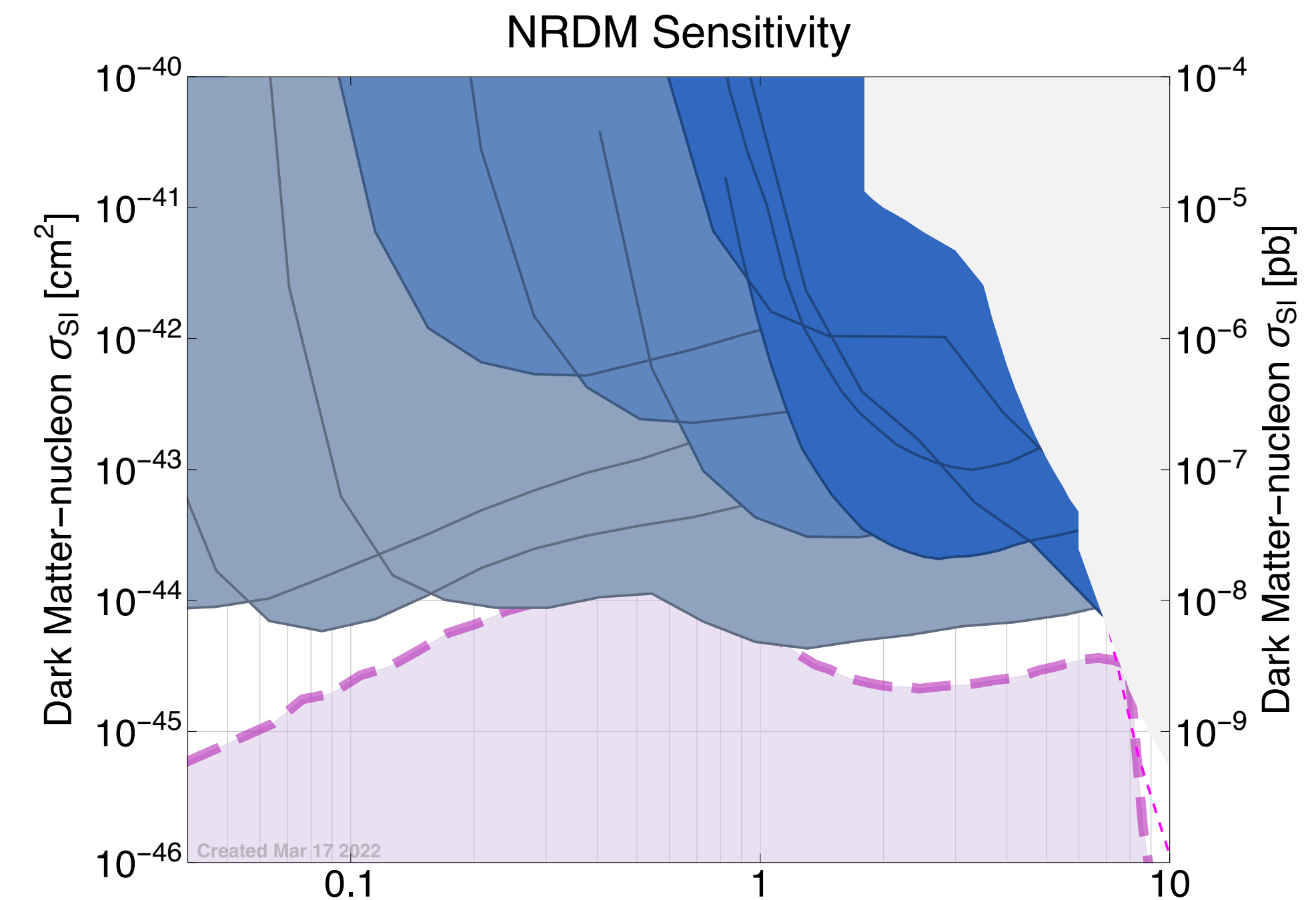



# SuperCDMS SNOLAB Schedule

**2018 - 2020:** SNOLAB Infrastructure, Clean room, Radon mitigation, Shield delivered

**2020:** COVID delays in tower assembly, cryostat redesign

Detector Towers delivered **Fall 2022**

**CUTE:** Co-located cryostat capable of holding a complete tower

Commissioned in **2019**, Recommences **Fall 2020**

Early science + Test towers **2022 - 2023**

**SNOBOX** Commissioning **2023**

Initial 4-tower payload **starts 2024**

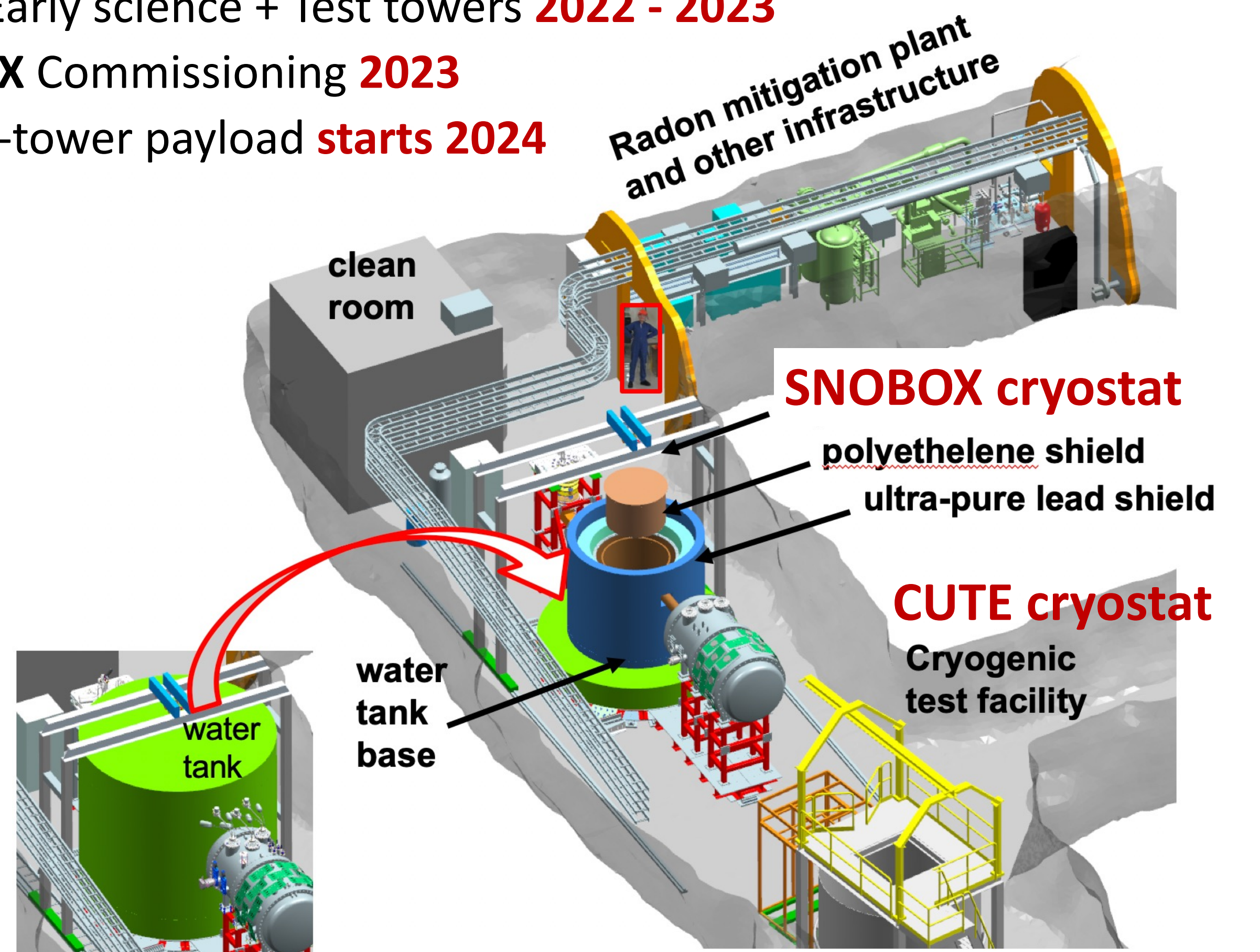

# 2019-2022: Off-site test facilities

## TUNL neutron beam experiment

7/19: Ionization yield measurement in Si complete

2/2022: Low energy yield result in Si announced

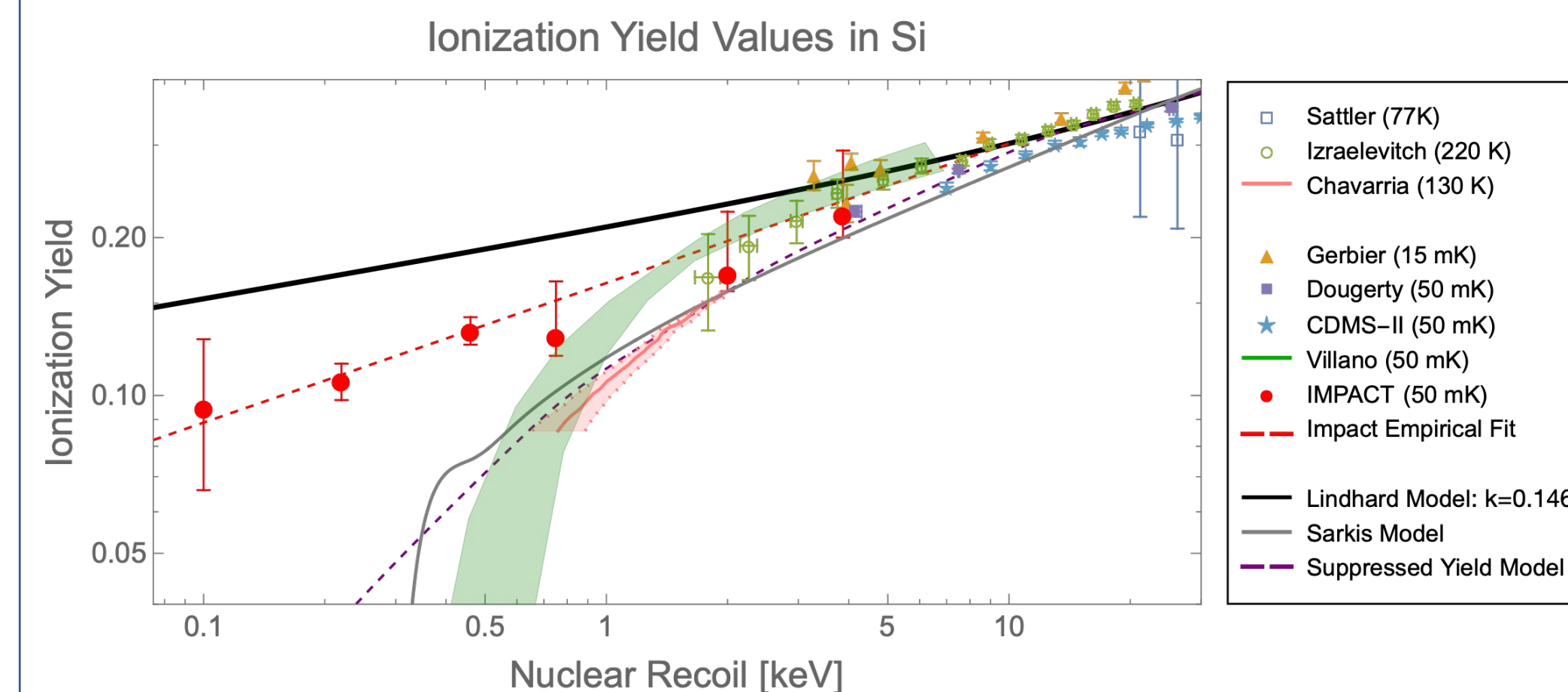

## NEXUS@FNAL + DD generator

2022-23: Si and Ge HVeV detector runs

2023: Ionization yield in SuperCDMS HV







# Facility Overview

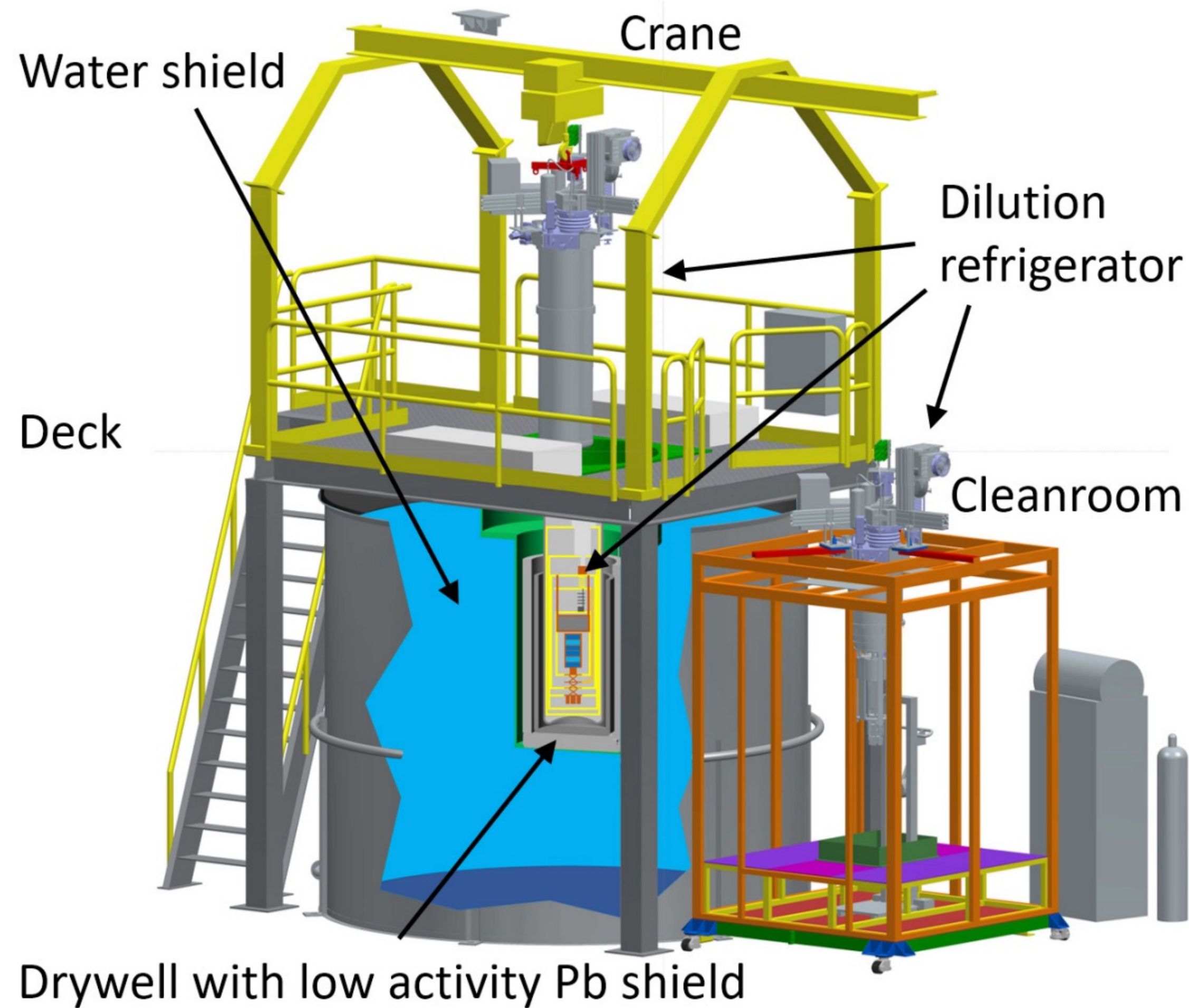



# Summary

---



- SNOLAB is a clean, underground laboratory hosting many direct detection of dark matter experiments
- Experimental collaborations have produced many dark matter results at SNOLAB, and many more are expected over the next decade



Questions?



# Partners

---





# Expansion Concept

- Expansion study conceptual, phased design complete
- Estimated CAD \$200M, 5 years
- No current path for funding, and would require demand from the research community
- **Expect space to be constrained over the 2023-2029 period, rotating experiments through existing floor space**

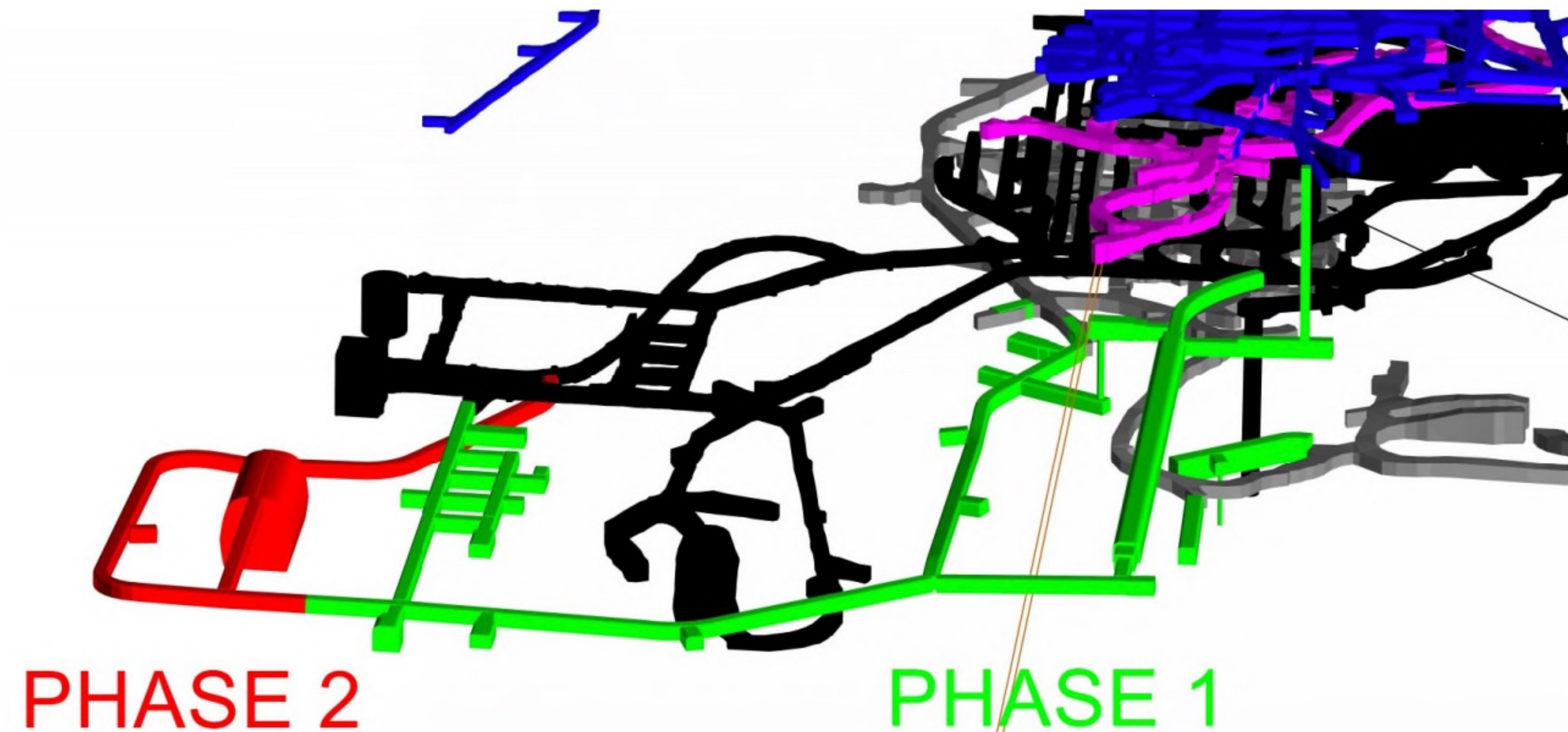



# Large Cavity Status

## Cube Hall

DEAP-3600, PICO500, NEWS-G  
potential for large project

## Cryopit

Ton-scale 0vbb beyond 2030  
pending community decisions

## SNO Cavern

SNO+ beyond 2030

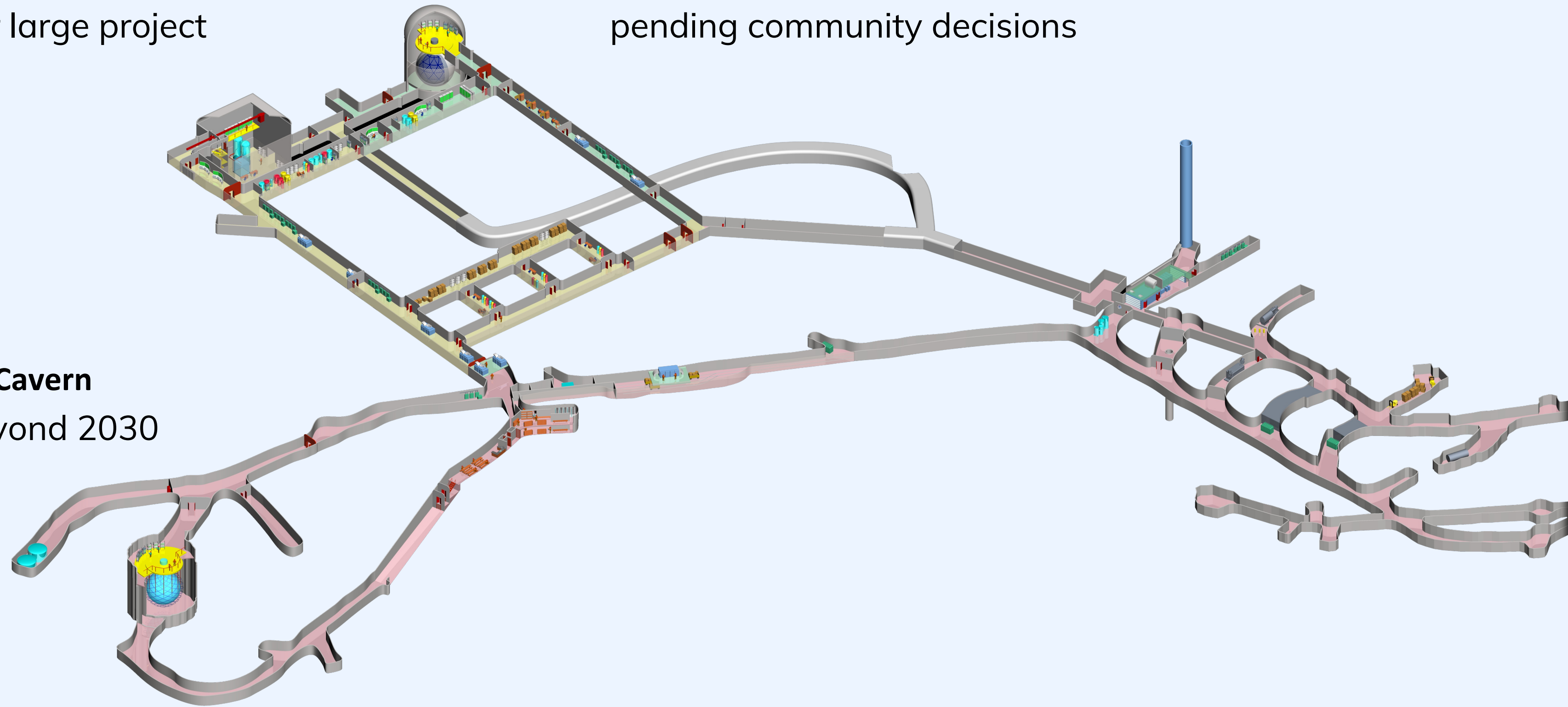



# Small Cavity Status

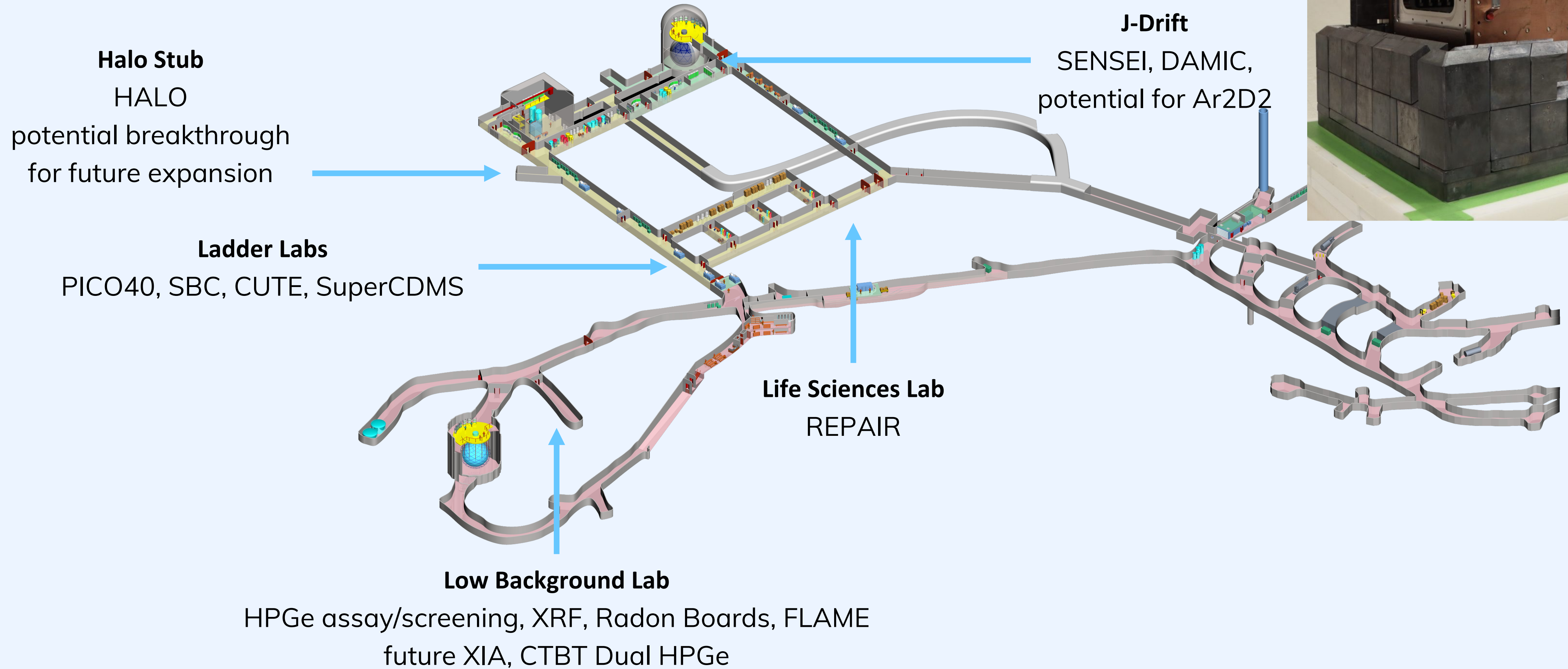



# Models of Radiation Risk

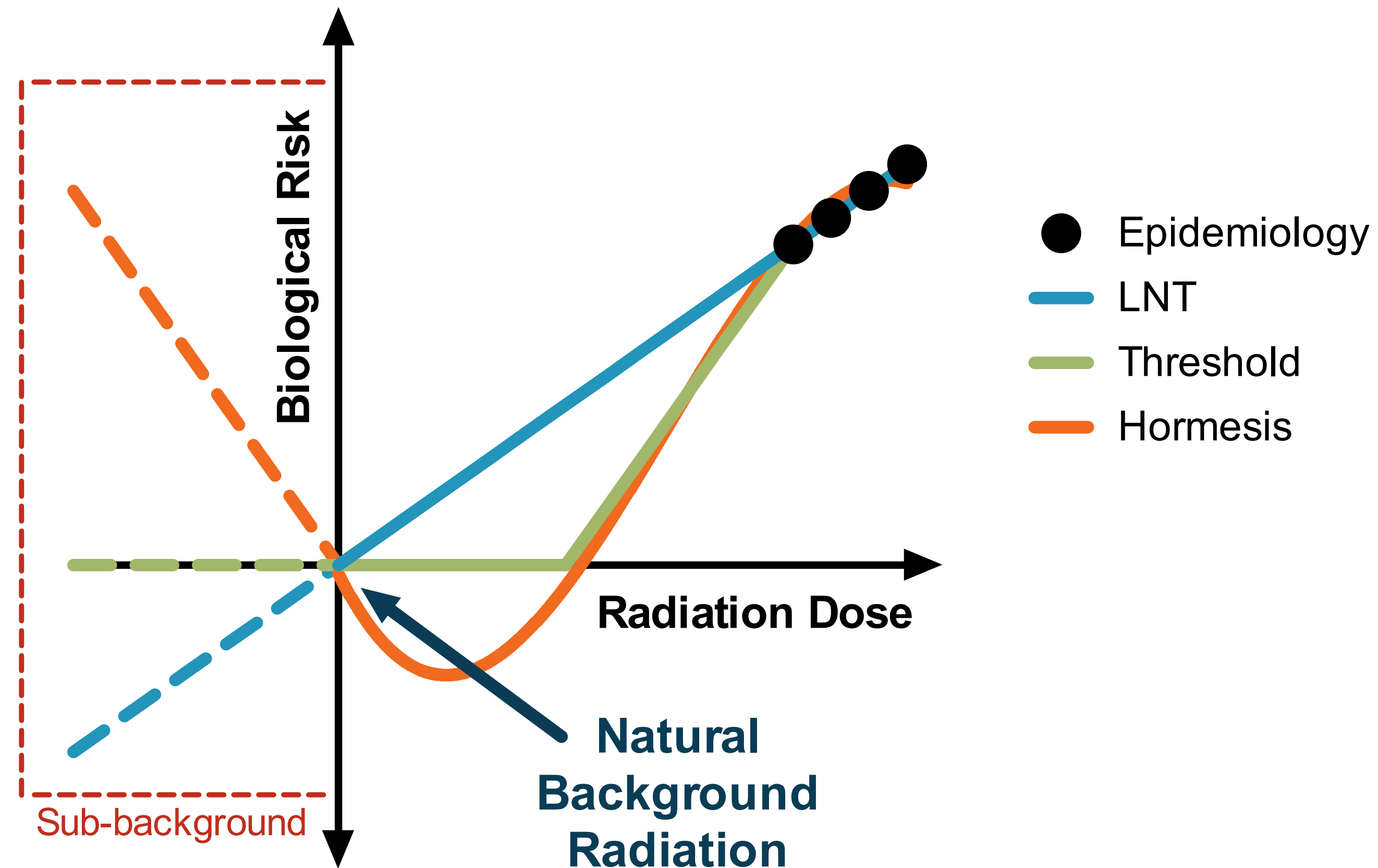

## Hypothesis

Natural background radiation is essential for life and helps to maintain the stability of our genome. Removal of background radiation will be detrimental to living systems.



# REPAIR Methodology

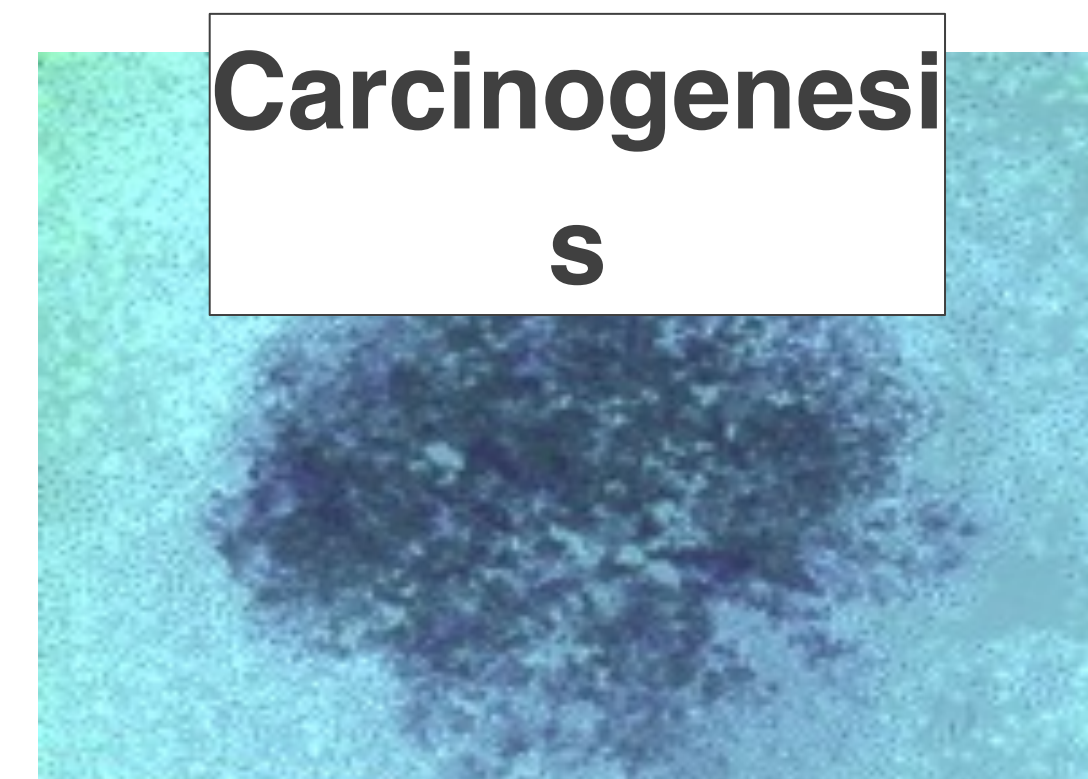
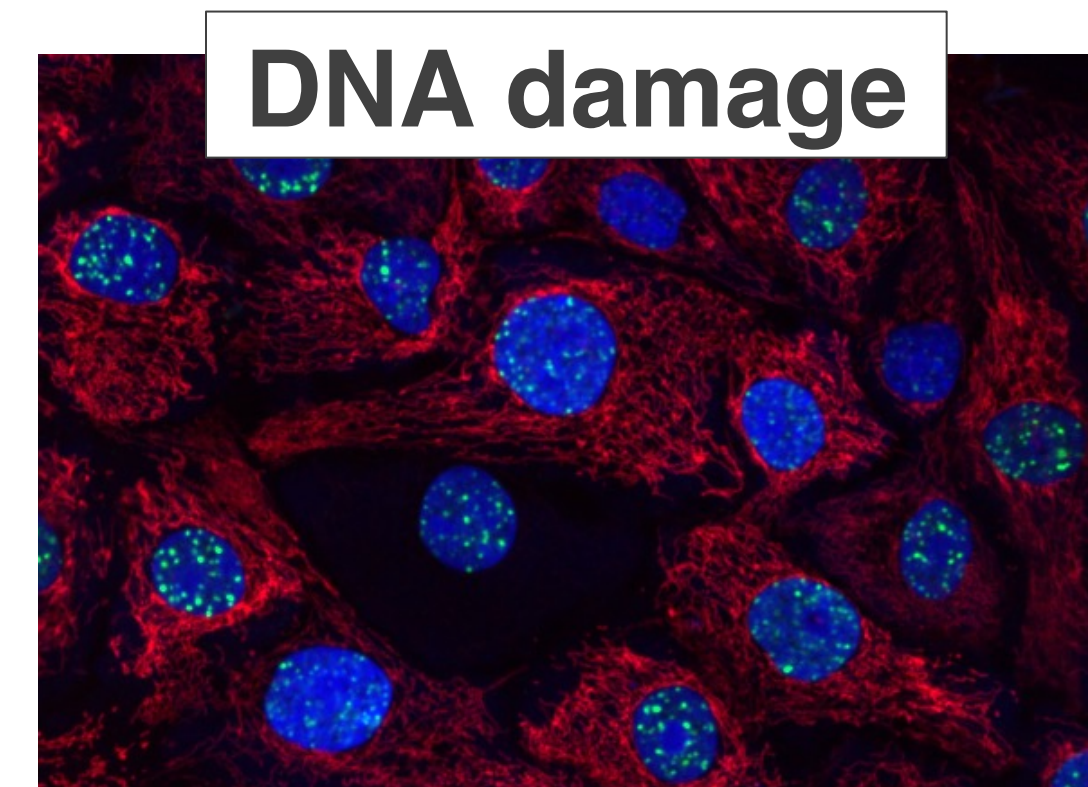
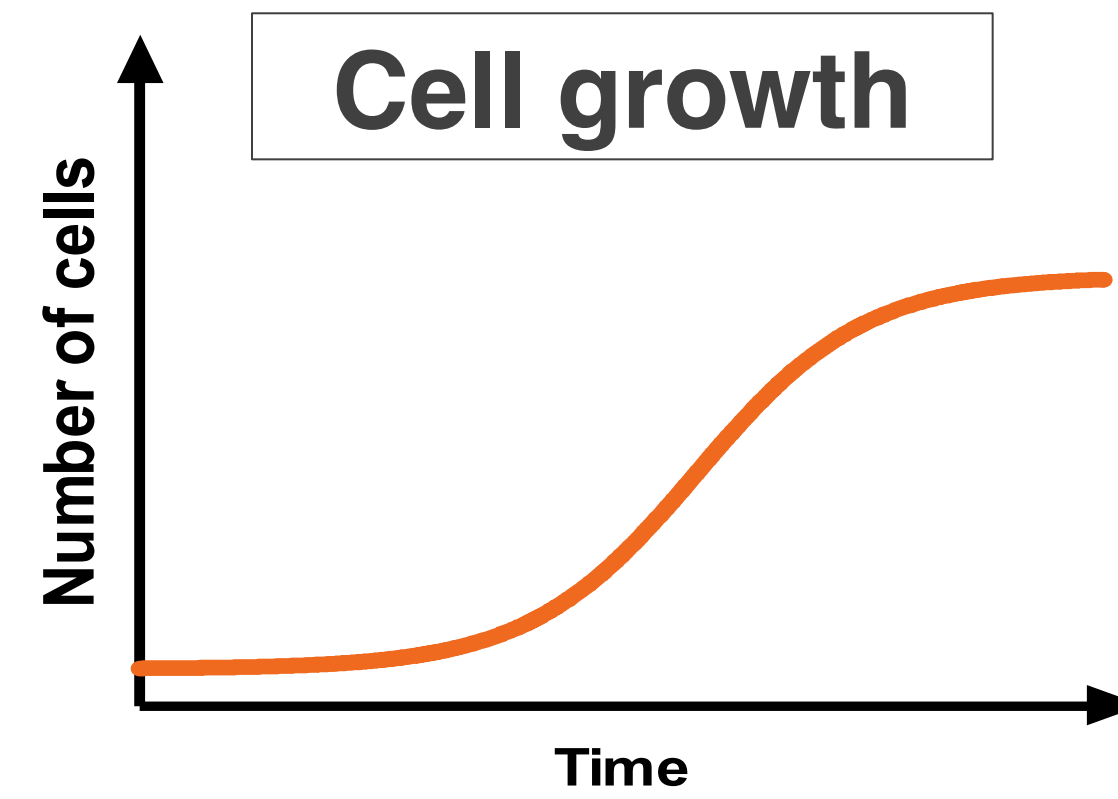
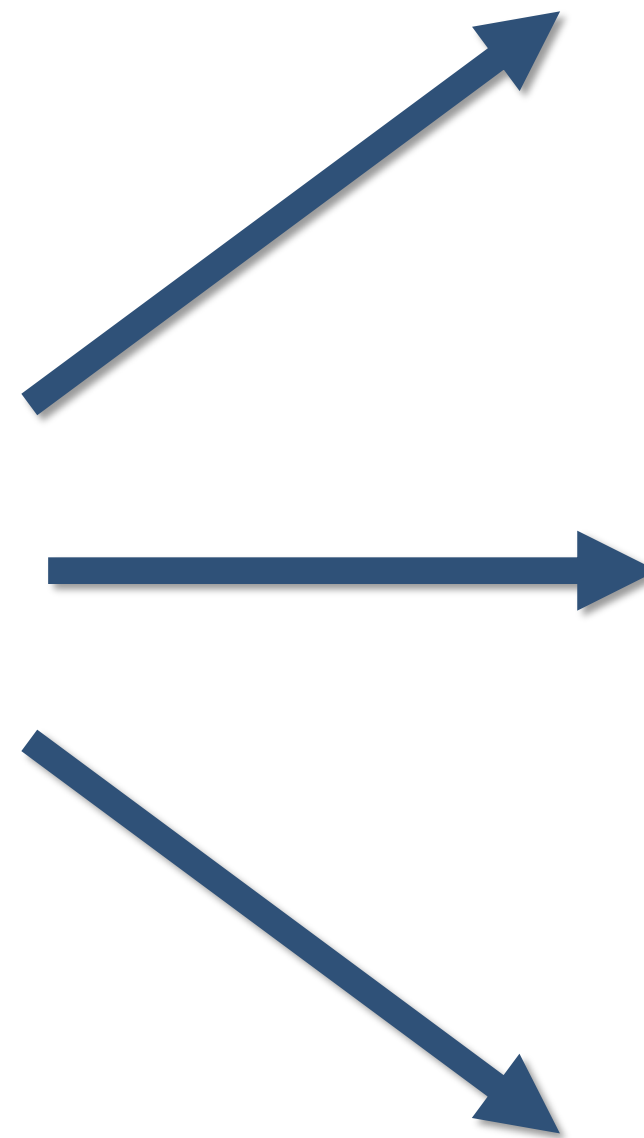
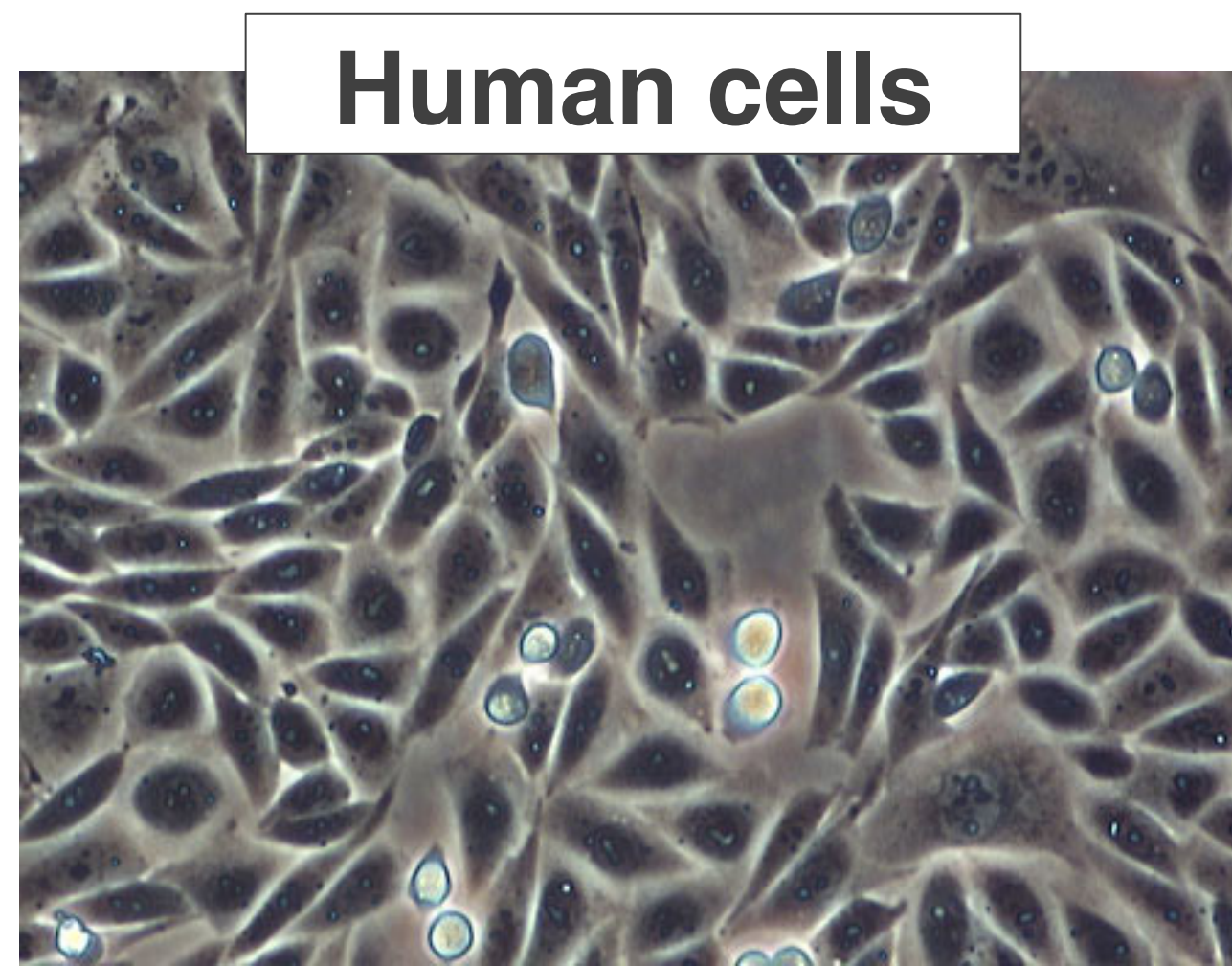

Courtesy of REPAIR Collaboration





## Additional SNOLAB Infrastructure

---

Power and Cooling (~2 MW capacity)

Backup Generator (2019)

Purified water (140 L/min capacity)

Purified liquid scintillator (LAB+PPO)

Network (10 Gb/s, more fibers available)

Wet chemistry lab (fume hood just operational)

Machine shop at surface and underground

Surface laboratories for additional chemistry and assembly (4700 ft<sup>2</sup>, class 1000)

Offices, Meeting rooms, Auditorium



# New Underground LN2 Plant

The LN2 Plant is operational since May 2022, creating high purity LN2 (99.999%)\* at 3,000 L/week.

It is currently used for cooling down the HPGe detectors and will soon provide it GN2 through the LBL gas distribution system.

It is currently supplying the CUTE facility, and soon all users at SNOLAB will use this LN2 system.

\* <0.001% oxygen





# Laboratory Possibilities

By combining advanced technology within deep underground laboratories, can achieve **unprecedented sensitivities**

Proposed joint project between **HC** and **SNOLAB** aims to explore this, will result in **world best detection capabilities** when measuring these environmental samples

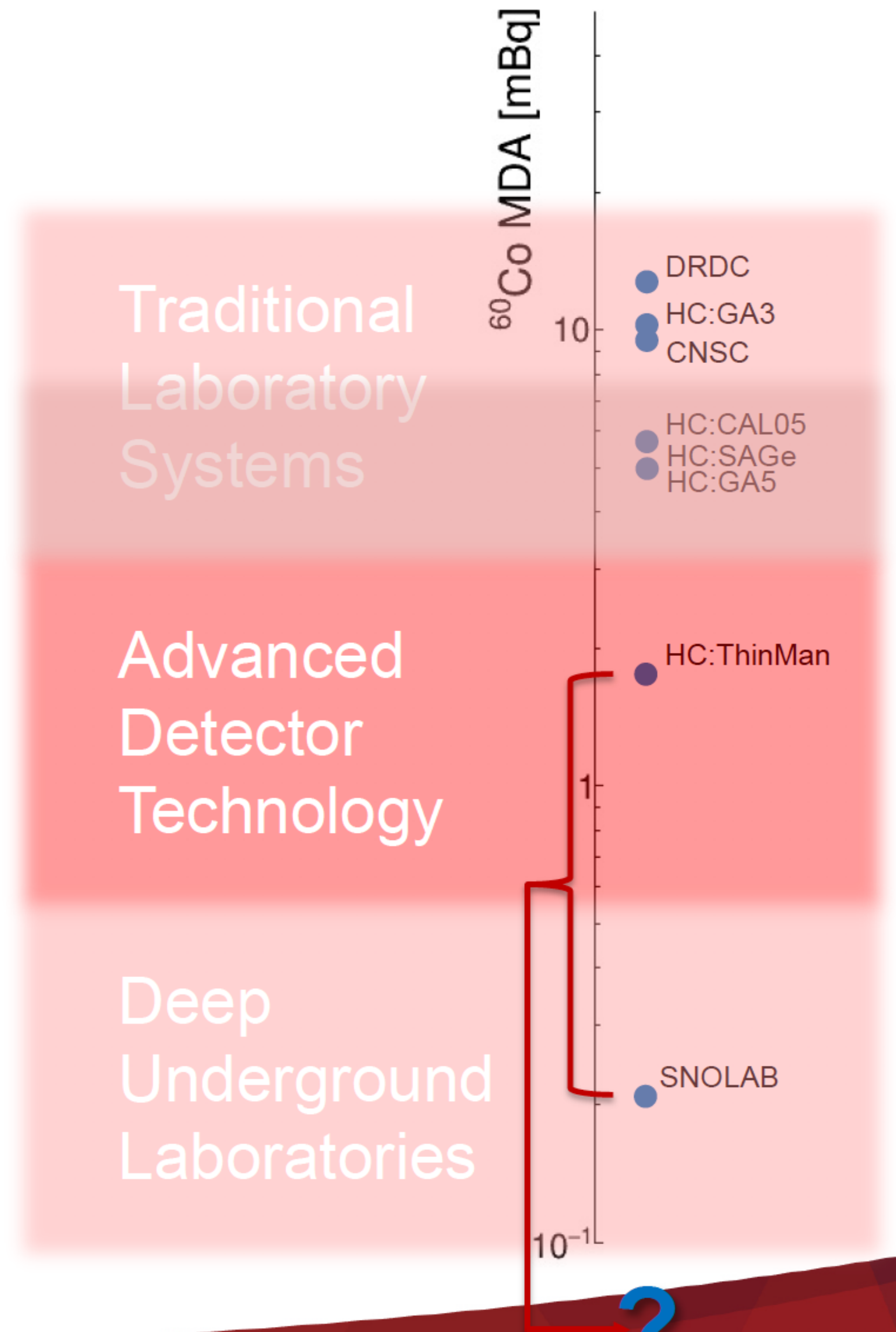





# Updated Radiopurity.org Framework

## Pacific Northwest National Laboratory, SNOLAB

### Material Assay Data Format (MADF)

Standardized, but flexible, json format

### Database Assistant **New!**

Open source format for storing, displaying and manipulating MADFs

### Public instance maintained by SNOLAB

<https://www.radiopurity.org/> **Upgraded!**

Can share results easily with community when ready

### MongoDB Database and python-based toolkit

Up-to-date standardized codebase

### Improved structure, ability to modify

'old versions' collection in database to track changes to entries (linked by document ID)

This replaces a deprecated CouchDB database (Persephone)