

Lecture III: Extra-Dimensional and Technicolor/Composite Higgs models

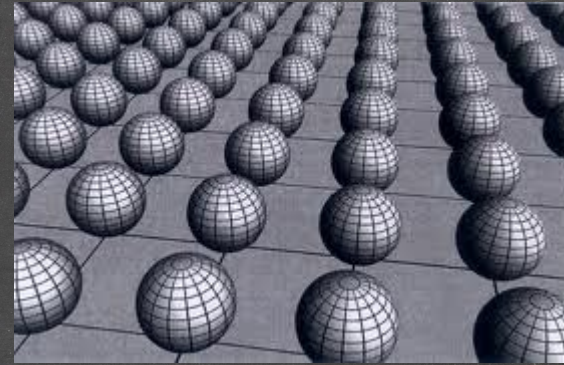

eXtra Dimensions (XD)

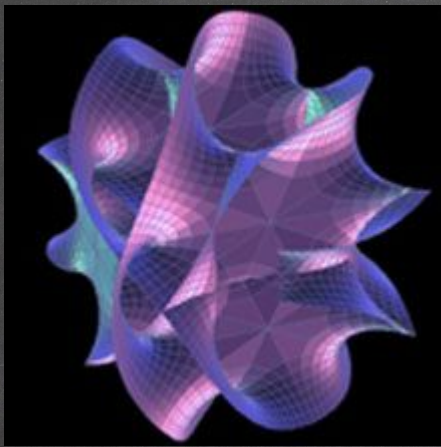
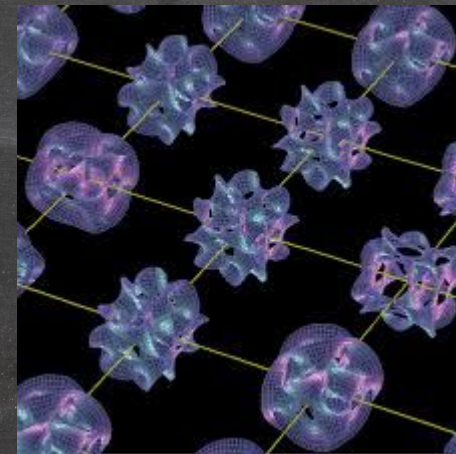
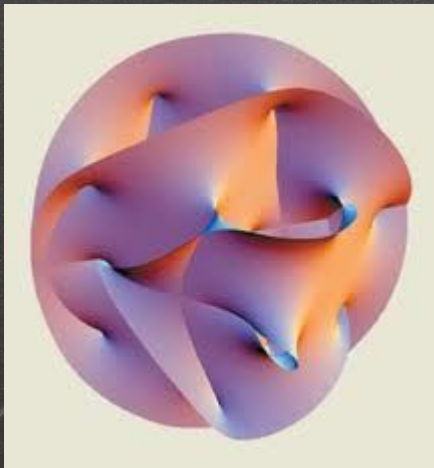

Motivations for XD

- String theory, the best candidate to unify gravity & gauge interactions,
is only consistent in 10 D space-time
- Extending symmetries:
Internal symmetries - GUTs, technicolour...; Fermionic spacetime- SUSY
Bosonic spacetime - Extra dimensions
- The presence of XD could have an impact on scales $\ll M_{\text{planck}}$ (started with ADD)
The question is what is the size and the shape of XD ?!

New perspectives of XD

- The nature of electroweak symmetry breaking
- The origin of fermion mass hierarchies
- The supersymmetry breaking mechanism
- The description of strongly interacting sectors (provide a way to model them)
-

Brief History

- 1914: Nordstrom tried to unify gravity and electromagnetism in 5D
($A_\mu \rightarrow A_M$, where $M = 0, 1, 2, 3, 4$)
- 1920's: Kaluza and Klein tried using Einstein's equations in 5D ($g^{\mu\nu} \rightarrow g^{MN} \sim g^{\mu\nu}, g^{\mu 4}, g^{44}$)
- 1970's: Development of superstring theory and supergravity required extra dimensions
- 1998: Arkani-Hamed, Dimopoulos, and Dvali propose **Large Extra Dimensions** (ADD) as a solution to the Hierarchy /Fine tuning problem of the Standard Model

The idea of ADD

- The Standard Model has been tested to $r \sim 10^{-16}$ mm, Gravity has been tested to $r \sim 1$ mm only

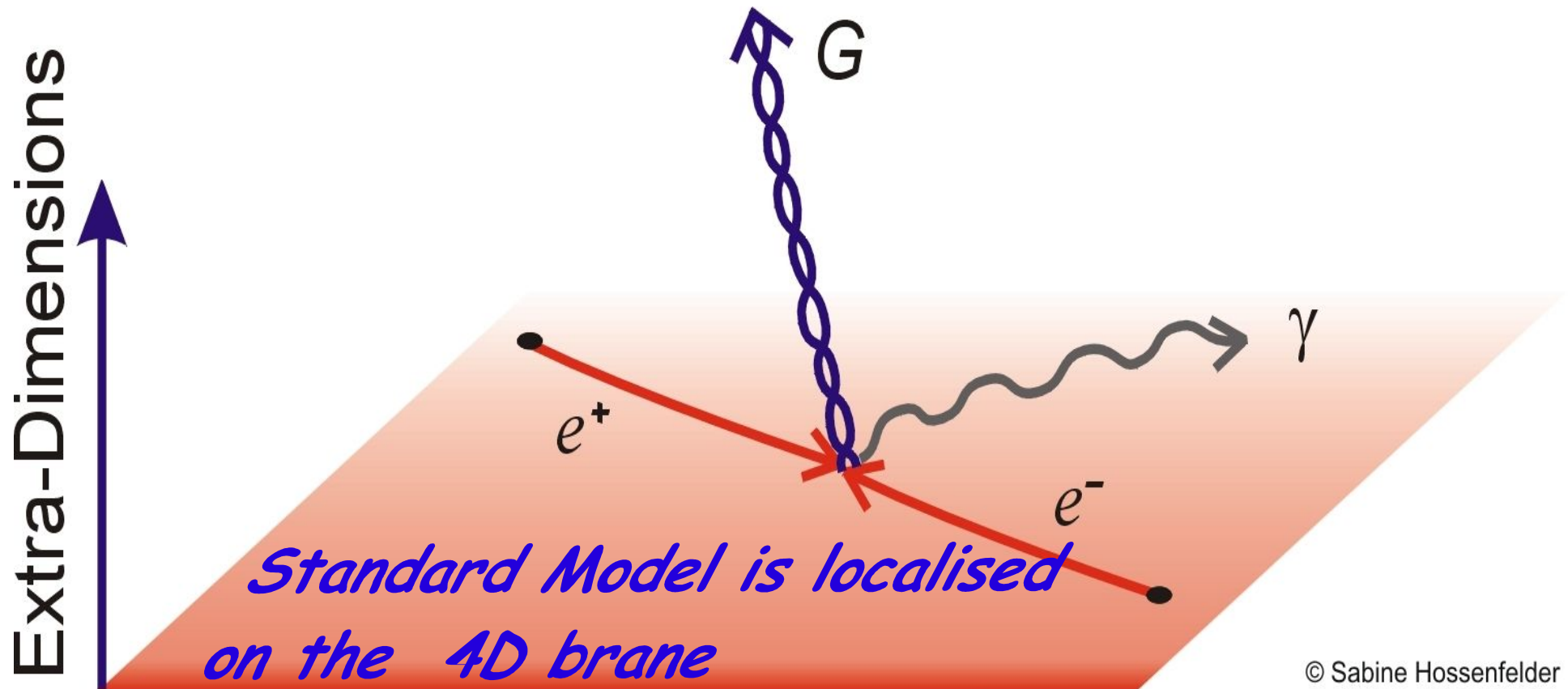

The idea of ADD

- The Standard Model has been tested to $r \sim 10^{-16}$ mm, Gravity has been tested to $r \sim 1$ mm only
- **4D \rightarrow (4 + n)D**

The effective D = 4 action is

$$\frac{M_f^{2+n}}{2} \int d^4x \int_0^{2\pi R} d^n Z \sqrt{G} R_{4+n} \longrightarrow \frac{1}{2} M_f^{2+n} V_n \int d^4x \sqrt{g} R$$

In case of toroidal compactification of equal radii, R

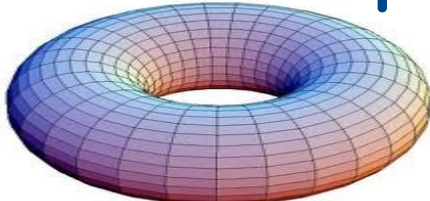
$$V_n = (2\pi R)^n \quad \text{Mandelbrot torus} \quad M_P^2 = M_f^{2+n} V_n$$

The idea of ADD

- The Standard Model has been tested to $r \sim 10^{-16}$ mm, Gravity has been tested to $r \sim 1$ mm only
- **4D \rightarrow (4 + n)D**

The effective D = 4 action is

$$\frac{M_f^{2+n}}{2} \int d^4x \int_0^{2\pi R} d^n Z \sqrt{G} R_{4+n} \longrightarrow \frac{1}{2} M_f^{2+n} V_n \int d^4x \sqrt{g} R$$

In case of toroidal compactification of equal radii, R

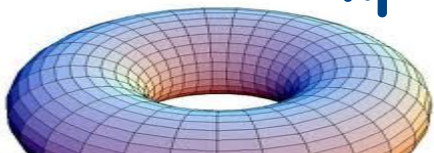
$$V_n = (2\pi R)^n$$

$$M_P^2 = M_f^{2+n} V_n$$

$r \gg R \Rightarrow$ the torus
effectively disappear

$$V(r) = -G_N \frac{m_1 m_2}{r} = -\frac{m_1 m_2}{M_P^2 r}$$

The idea of ADD

- The Standard Model has been tested to $r \sim 10^{-16}$ mm, Gravity has been tested to $r \sim 1$ mm only
- **4D \rightarrow (4 + n)D**

The effective D = 4 action is

$$\frac{M_f^{2+n}}{2} \int d^4x \int_0^{2\pi R} d^n Z \sqrt{G} R_{4+n} \longrightarrow \frac{1}{2} M_f^{2+n} V_n \int d^4x \sqrt{g} R$$

In case of toroidal compactification of equal radii, R

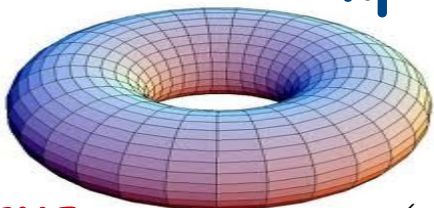
$$V_n = (2\pi R)^n$$

$$M_P^2 = M_f^{2+n} V_n$$

$r \gg R \Rightarrow$ the torus effectively disappear

$$V(r) = -G_N \frac{m_1 m_2}{r} = -\frac{m_1 m_2}{M_P^2 r}$$

$r \ll R \Rightarrow$ observer is able to feel the bulk

$$V(r) = -G_* \frac{m_1 m_2}{r} = -\frac{m_1 m_2}{M_f^{2+n} r^{1+n}}$$

The idea of ADD

- The Standard Model has been tested to $r \sim 10^{-16}$ mm, Gravity has been tested to $r \sim 1$ mm only
- **4D \rightarrow (4 + n)D**

The effective D = 4 action is

$$\frac{M_f^{2+n}}{2} \int d^4x \int_0^{2\pi R} d^n Z \sqrt{G} R_{4+n} \longrightarrow \frac{1}{2} M_f^{2+n} V_n \int d^4x \sqrt{g} R$$

In case of toroidal compactification of equal radii, R

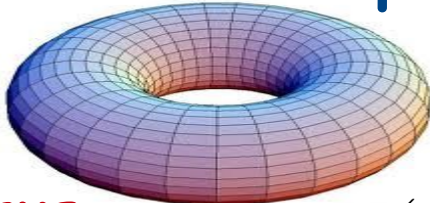
$$V_n = (2\pi R)^n$$

$$M_P^2 = M_f^{2+n} V_n$$

$r \gg R \Rightarrow$ the torus effectively disappear

$r \ll R \Rightarrow$ observer is able to feel the bulk

$$V(r) = -G_N \frac{m_1 m_2}{r} = -\frac{m_1 m_2}{M_P^2 r}$$

$$V(r) = -G_* \frac{m_1 m_2}{r} = -\frac{m_1 m_2}{M_f^{2+n} r^{1+n}}$$

Fundamental quantum gravity scale



$$M_f^{2+n} r^{1+n}$$

The current status of ADD

So, $M_P^2 = M_f^{n+2} (2\pi R)^n$ and respectively,

$$R = \frac{1}{2\pi} \frac{1}{M_f} \left(\frac{M_P}{M_f} \right)^{\frac{2}{n}} [\text{GeV}^{-1}] \times 0.197 [\text{GeV m}]$$

How big are these dimensions are?
Let us assume $M_f \sim 1 \text{ TeV}$, then

$$R \sim \begin{cases} 10^{15} \text{ mm} & n = 1 \quad \times \text{ Already} \\ 1 \text{ mm} & n = 2 \quad \times \text{ ruled out} \\ 10^{-6} \text{ mm} & n = 3 \\ \vdots & \end{cases}$$

Collider signature:

$$pp \rightarrow \text{jet} + \cancel{E}_T$$

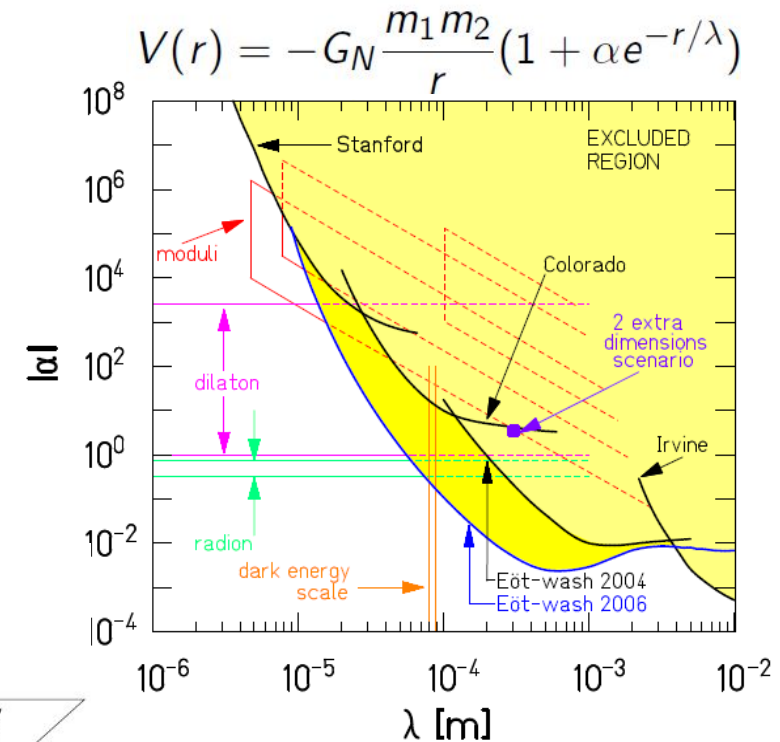
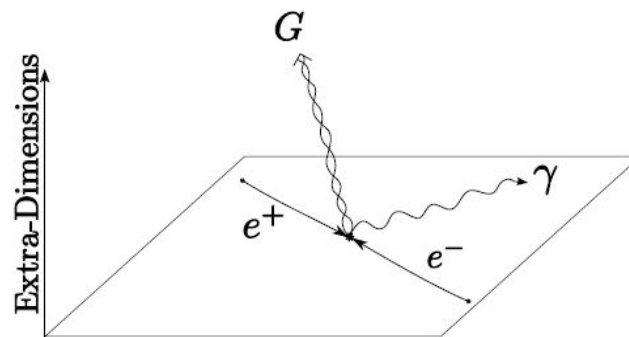

The current bound is $R < 37 \mu\text{m}$
For $n = 2$ this means that
 $M > 1.4 \text{ TeV}$

KK-towers from XD

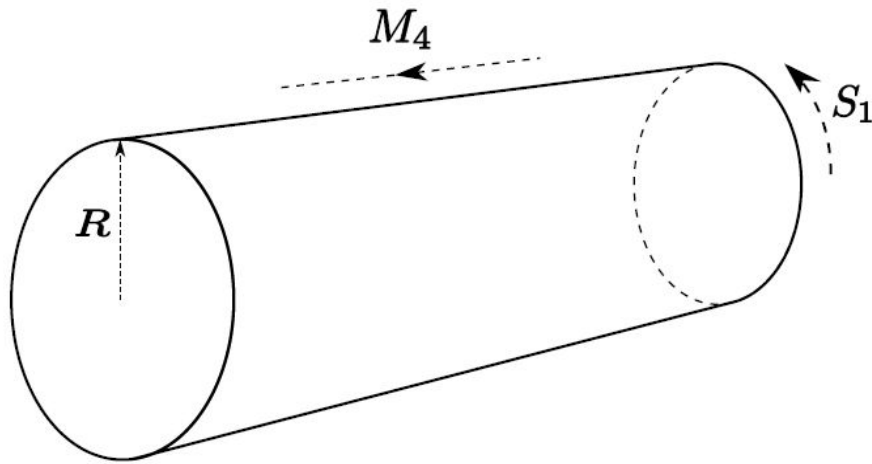

$$\Phi(x_\mu, Z) = \Phi(x_\mu, Z + 2\pi R)$$
$$\mu = 0, 1, 2, 3$$

Periodicity in Z

KK-towers from XD

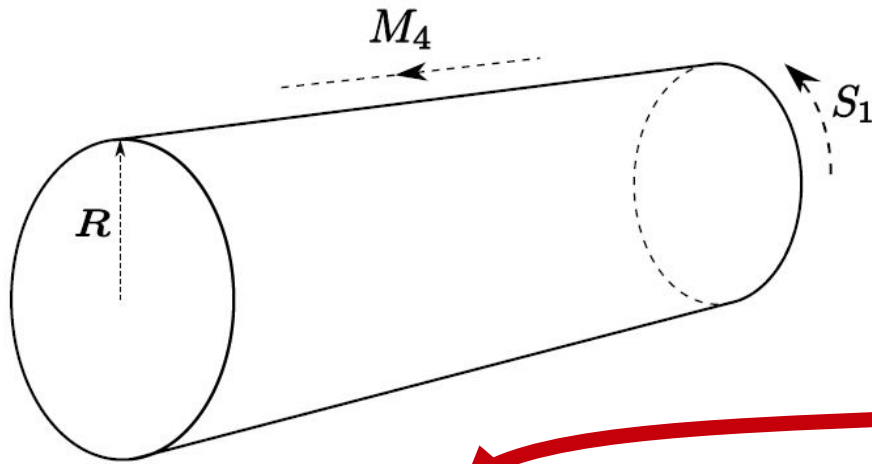

$$\Phi(x_\mu, Z) = \Phi(x_\mu, Z + 2\pi R)$$
$$\mu = 0, 1, 2, 3$$

Periodicity in Z

Fourier series

$$\Phi(x_\mu, Z) = \sum_{k=0, \pm 1, \dots} \phi_k(x_\mu) e^{ikZ/R}$$

KK-towers from XD

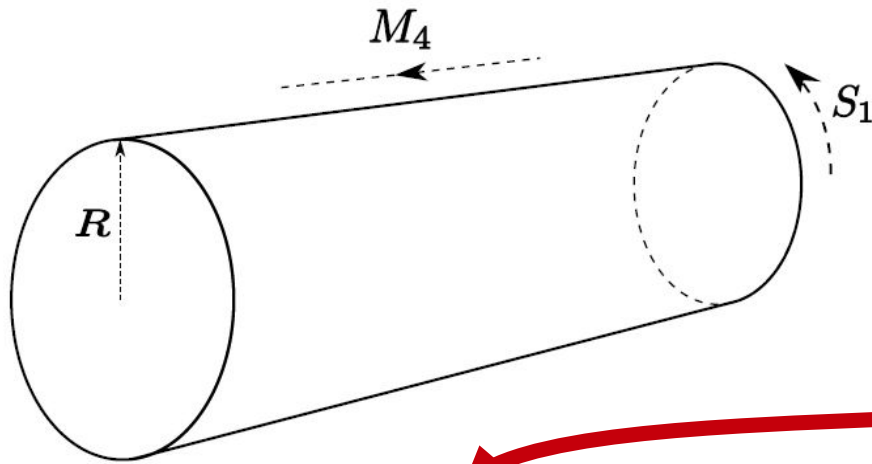

$$\Phi(x_\mu, Z) = \Phi(x_\mu, Z + 2\pi R)$$

$$\mu = 0, 1, 2, 3$$

Periodicity in Z

Fourier series

$$\Phi(x_\mu, Z) = \sum_{k=0, \pm 1, \dots} \phi_k(x_\mu) e^{ikZ/R}$$

The non-zero modes in the KK decomposition

$$\square_5 \Phi(x_\mu, Z) \equiv \left(\partial_\mu^2 - \frac{\partial^2}{\partial Z^2} \right) \Phi(x_\mu, Z) = 0$$

$$\left(\square_4 + \frac{k^2}{R^2} \right) \phi_k(x_\mu) \equiv \left(\partial_\mu^2 + \frac{k^2}{R^2} \right) \phi_k(x_\mu) = 0$$

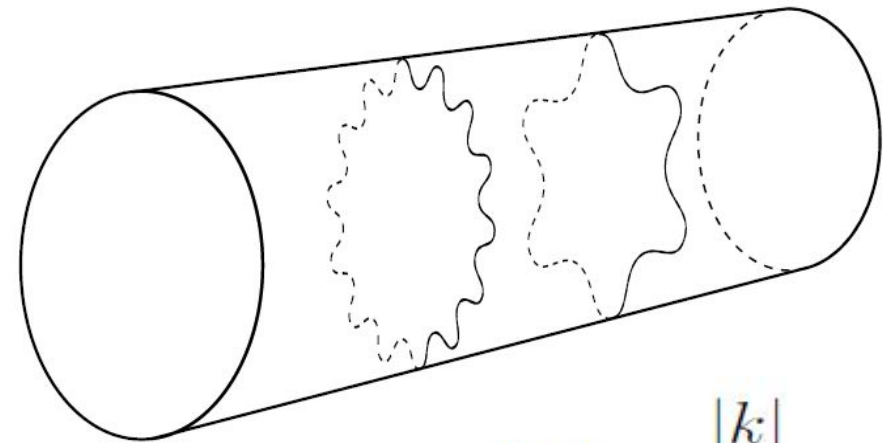

$$m_k = \frac{|k|}{R}$$

From Brane - to Bulk: Universal Extra Dimensions (UED)

[Appelquist, Cheng, Dobrescu '01]

- all fields propagate in the extra dimensions, so $1/R > 1 \text{ TeV}$ to obey experimental data
- for $D=5$ (minimal UED = MUED) we immediately find that $M_f = 10^{15} \text{ GeV}$ for $1/R = 1 \text{ TeV}$
- hierarchy problem is not addressed but MUED has interesting features ...

Minimal Universal Extra Dimensions compactifying on the circle

$$\phi(x, y) = \frac{1}{\sqrt{2\pi R}} \phi_0(x) + \sqrt{\frac{\pi}{R}} \sum_{n=1}^{\infty} \left[\phi_n^+(x) \cos \frac{ny}{R} + \phi_n^-(x) \sin \frac{ny}{R} \right]$$

$$S = \int d^4x \int_0^{2\pi R} dy \underbrace{\frac{1}{2} \left[\partial_M \phi \partial^M \phi - m^2 \phi(x, y)^2 \right]}_{\mathcal{L}_5}$$

\mathcal{L}_4

$$\mathcal{L}_4 = \frac{1}{2} \left[\partial_\mu \phi_0 \partial^\mu \phi_0 - m^2 \phi_0^2 \right] + \sum_{n=1}^{\infty} \frac{1}{2} \left[\partial_\mu \phi_n^\pm \partial^\mu \phi_n^\pm - \overbrace{\left(m^2 + \frac{n^2}{R^2} \right)}^{m_n^2} \phi_n^\pm{}^2 \right]$$

- ▶ all fields propagate in the bulk - 5D momentum conservation

Minimal Universal Extra Dimensions compactifying on the circle

$$\phi(x, y) = \frac{1}{\sqrt{2\pi R}} \phi_0(x) + \sqrt{\frac{\pi}{R}} \sum_{n=1}^{\infty} \left[\phi_n^+(x) \cos \frac{ny}{R} + \phi_n^-(x) \sin \frac{ny}{R} \right]$$

$$S = \int d^4x \int_0^{2\pi R} dy \underbrace{\frac{1}{2} \left[\partial_M \phi \partial^M \phi - m^2 \phi(x, y)^2 \right]}_{\mathcal{L}_5}$$

\mathcal{L}_4

$$\mathcal{L}_4 = \frac{1}{2} \left[\partial_\mu \phi_0 \partial^\mu \phi_0 - m^2 \phi_0^2 \right] + \sum_{n=1}^{\infty} \frac{1}{2} \left[\partial_\mu \phi_n^\pm \partial^\mu \phi_n^\pm - \overbrace{\left(m^2 + \frac{n^2}{R^2} \right)}^{m_n^2} \phi_n^{\pm 2} \right]$$

- ▶ all fields propagate in the bulk - 5D momentum conservation
- ▶ This leads to the KK-number conservation at this point: $\pm n_1 \pm n_2 = \pm n_3$

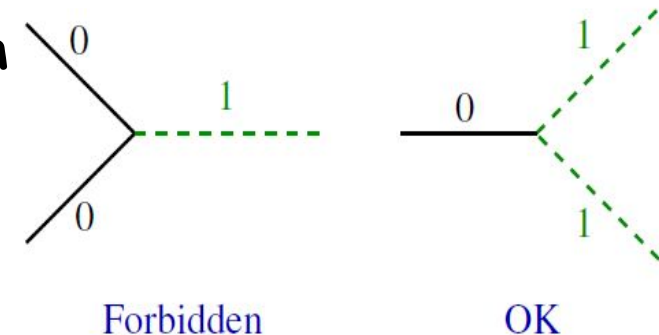

Universal Extra Dimensions (UED)

compactifying on the orbifold

- Choose action of Z_2 symmetry on Dirac Fermions to project out $\frac{1}{2}$ of them and arranges chirality:

$$\psi_{\pm}(y) \mapsto \psi'_{\pm}(-y) = \pm \gamma^5 \psi_{\pm}(y)$$

If we identify $y \sim -y$ then we require

$\psi'_{\pm}(y) = \psi_{\pm}(y)$, so

$$\psi_{\pm}(y) = \psi_0^{R,L} + \sum_n \left(\psi_n^{R,L} \cos_n + \psi_n^{L,R} \sin_n \right)$$

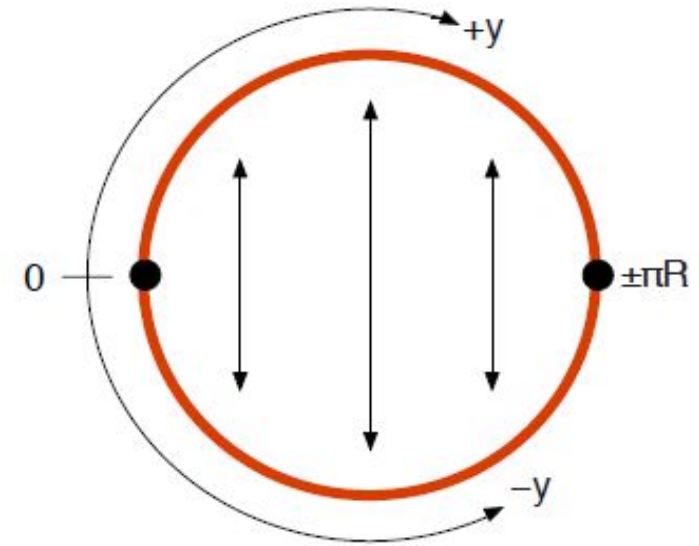

Universal Extra Dimensions (UED)

compactifying on the orbifold

- Choose action of Z_2 symmetry on Dirac Fermions to project out $\frac{1}{2}$ of them and arranges chirality:

$$\psi_{\pm}(y) \mapsto \psi'_{\pm}(-y) = \pm \gamma^5 \psi_{\pm}(y)$$

If we identify $y \sim -y$ then we require

$\psi'_{\pm}(y) = \psi_{\pm}(y)$, so

$$\psi_{\pm}(y) = \psi_0^{R,L} + \sum_n \left(\psi_n^{R,L} \cos_n + \psi_n^{L,R} \sin_n \right)$$

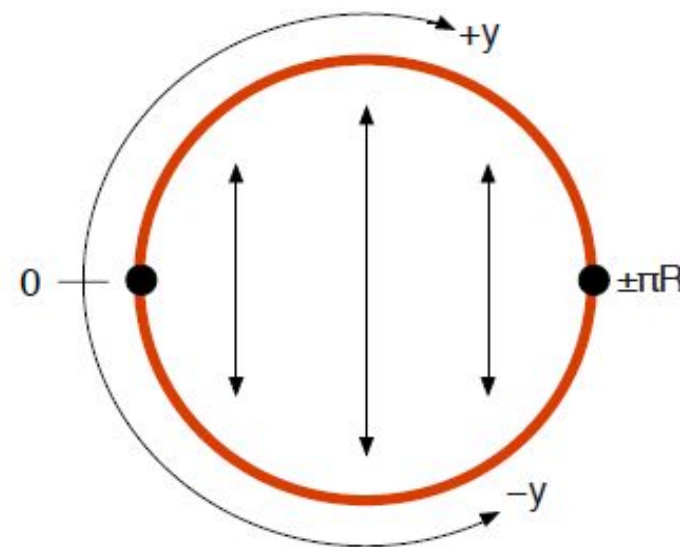

- Translational invariance along the 5th D is broken, but **KK parity is preserved!**
- KK number n broken down to the KK parity, $(-1)^n$:
KK excitations must be produced in pairs

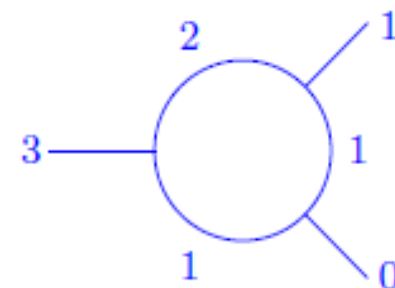
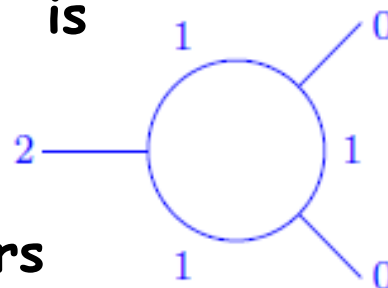

These vertices are allowed and can be generated at loop-level

- LKP is stable DM candidate!**

Minimal Universal Extra Dimensions

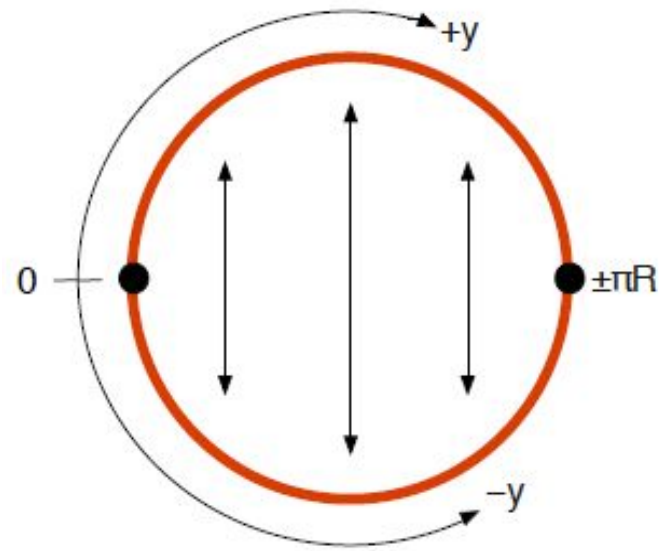

$$\text{SU}(3) \times \text{SU}(2) \times \text{U}(1)$$

$$\begin{aligned} \psi^{R,L}(x) &\rightarrow \psi^\pm(x, y) \\ A_\mu(x) &\rightarrow A_M(x, y) \\ \phi(x) &\rightarrow \phi(x, y) \end{aligned}$$

S^1/\mathbb{Z}_2 orbifold

SM Gauge group

SM field content

brane localised terms are zero at the cutoff scale



The role of radiative corrections

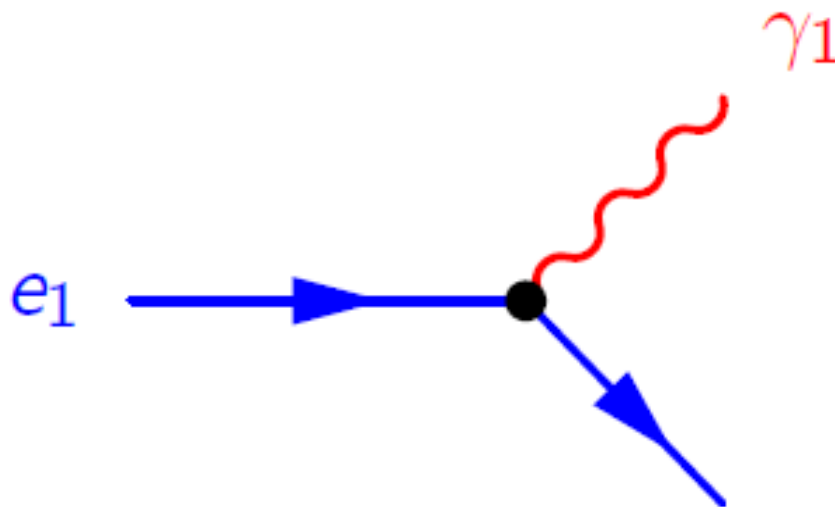

$$\sqrt{m_e^2 + \frac{1}{R}} < m_e + \frac{1}{R} (!!!)$$

e.g. the 1st KK excitation of the electron is stable at tree-level!

Dark Matter would be charged - which is not acceptable

Loop corrections come from 5D Lorentz violating processes. They appear as tree-level mass corrections in 4D.

- Bulk corrections :
the gauge bosons receive an extra mass which is KK-independent

$$\delta m_n^2 = \alpha_i \frac{1}{R^2}$$

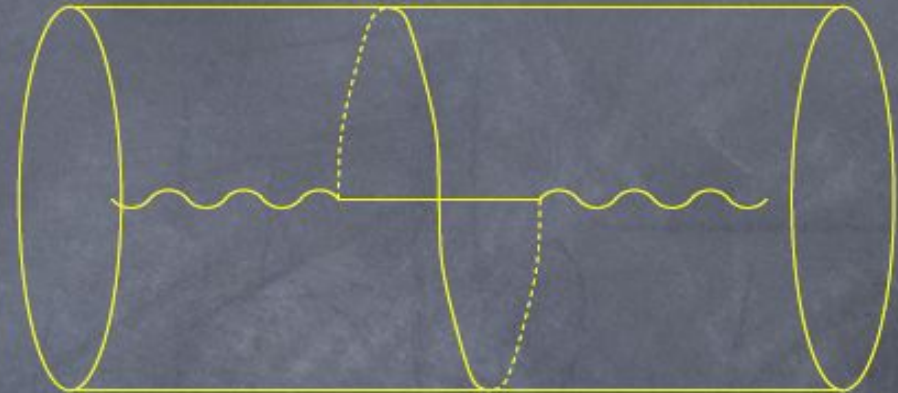

- Brane corrections : p_5 is not conserved, all particles receive a mass correction

$$\delta m_n = \beta_i \frac{n}{R} \ln \frac{\Lambda^2}{\mu^2} \quad \text{for fermions}$$

$$\delta m_n^2 = \beta_i \frac{n^2}{R^2} \ln \frac{\Lambda^2}{\mu^2} \quad \text{for bosons}$$

Problem : Electroweak symmetry breaking was not included

MUED spectrum at 1loop vs tree-level

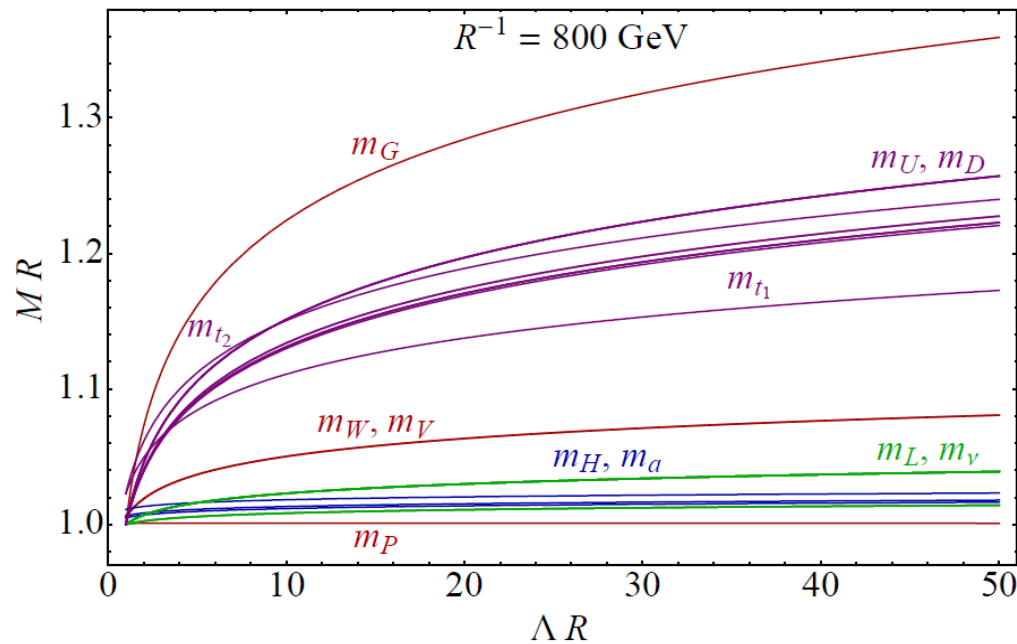
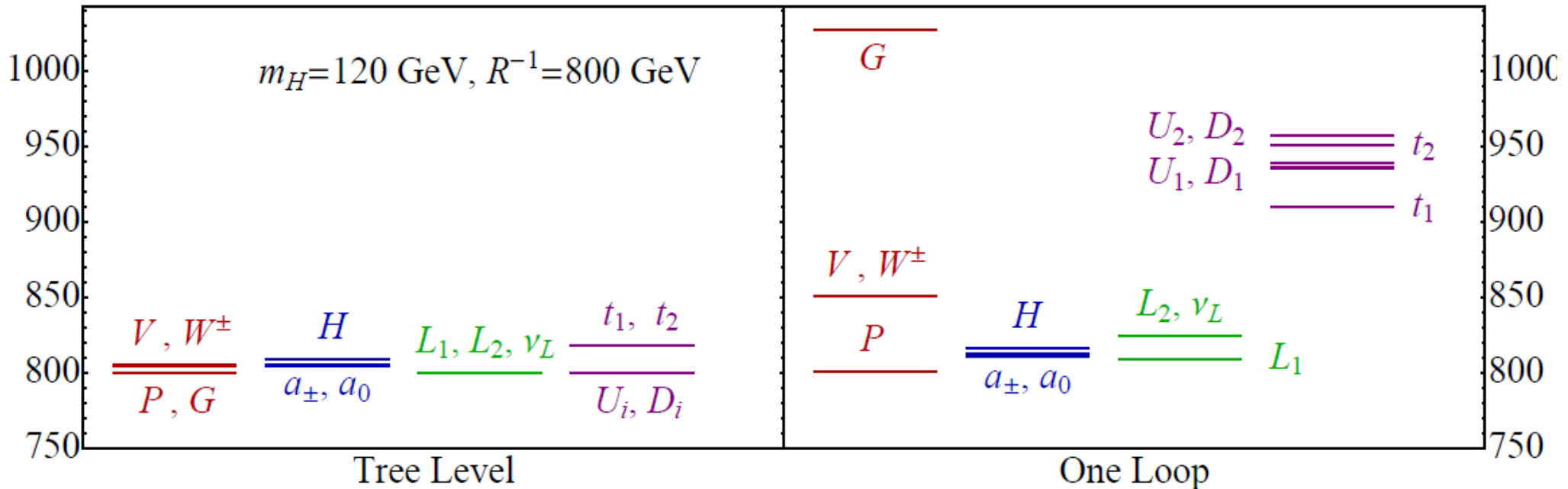

Model implementation

- MUED is implemented in Feynman and unitary gauges in LanHEP (generates the Feynman rules out of a Lagrangian) [AB,Brown,Moreno,Papineau arXiv:1212.4858] (BBMP)

Model implementation

- MUED is implemented in Feynman and unitary gauges in LanHEP (generates the Feynman rules out of a Lagrangian) [AB,Brown,Moreno,Papineau arXiv:1212.4858] (BBMP)
- Publicly available at High Energy Physcs Model Database (HEPMDB) <http://hepmdb.soton.ac.uk/hepmdb:1212.0121>

Model implementation

- MUED is implemented in Feynman and unitary gauges in LanHEP (generates the Feynman rules out of a Lagrangian) [AB,Brown,Moreno,Papineau arXiv:1212.4858] (BBMP)
- Publicly available at High Energy Physics Model Database (HEPMDB) <http://hepmdb.soton.ac.uk/hepmdb:1212.0121>
- Compared and Validated against existing implementation by Datta,Kong,Matchev, arXiv:1002.4624 (DKM) and private implementation from Belanger, Semenov, Pukhov,Kakizaki.

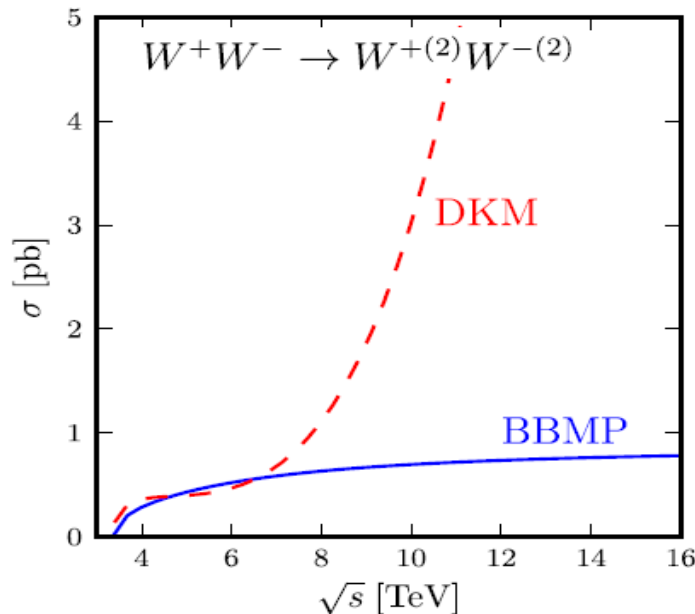
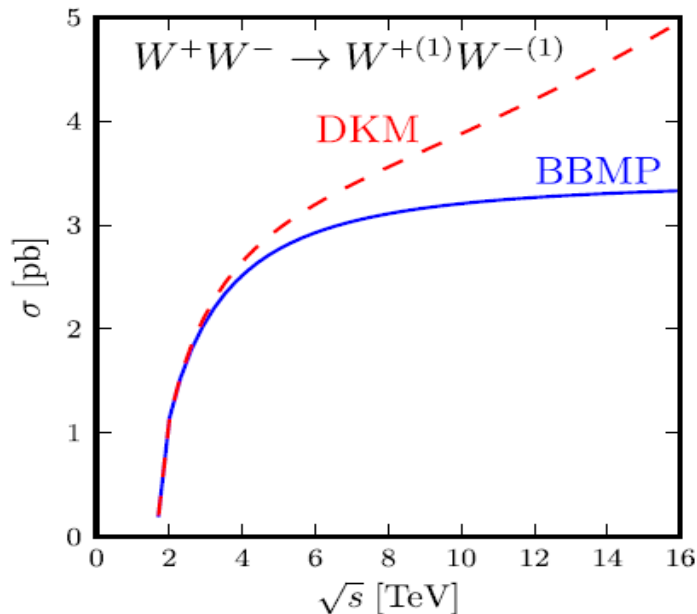

If the sum of KK numbers of the external particles is 5 or less [$<2*(n+1)$ in general] gauge invariance is ensured

Proper implementation of the Higgs sector lead to the correct High Energy asymptotic which respects Unitarity

EW precision constraints

The tower of KK particles modify the gauge bosons self-energies, contributing to the S, T, and U electroweak parameters:

T. Appelquist H.-U. Yee 2001
I. Gogoladze and C. Macesanu, 2006

$$S = \frac{4 \sin^2 \theta_W}{\alpha} \left[\frac{3g^2}{4(4\pi)^2} \left(\frac{2}{9} \frac{m_t^2}{M_{KK}^2} \right) \zeta(2) + \frac{g^2}{4(4\pi)^2} \left(\frac{1}{6} \frac{M_H^2}{M_{KK}^2} \right) \zeta(2) \right],$$

$$T = \frac{1}{\alpha} \left[\frac{3g^2}{2(4\pi)^2} \frac{m_t^2}{M_W^2} \left(\frac{2}{3} \frac{m_t^2}{M_{KK}^2} \right) \zeta(2) + \frac{g^2 \sin^2 \theta_W}{(4\pi)^2 \cos^2 \theta_W} \left(-\frac{5}{12} \frac{M_H^2}{M_{KK}^2} \right) \zeta(2) \right],$$

$$U = -\frac{4 \sin^2 \theta_W}{\alpha} \left[\frac{g^2 \sin^2 \theta_W}{(4\pi)^2} \frac{M_W^2}{M_{KK}^2} \left(\frac{1}{6} \zeta(2) - \frac{1}{15} \frac{M_H^2}{M_{KK}^2} \zeta(4) \right) \right],$$

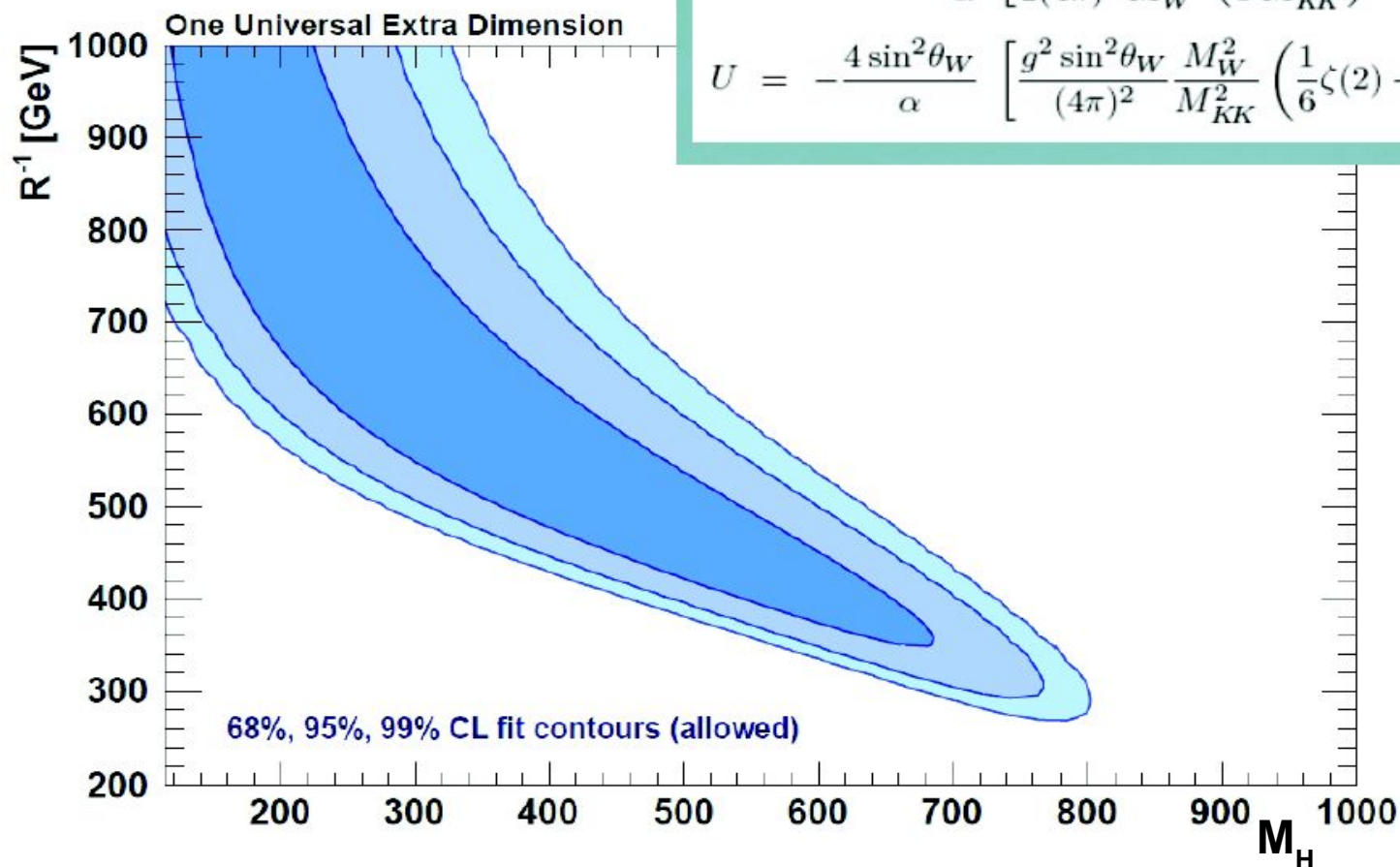

G **fitter**

arXiv: 1107.0975

FCNC and DM constraints

FCNC

K. Agashe, N.G. Deshpande, G.-H. Wu
L. A. J. Buras, A. Poschenrieder, M. Spranger, A. Weiler

KK modes will give contributions to FCNC processes . From $b \rightarrow s\gamma$

$$1/R > 600 \text{ GeV}$$

Cosmology (DM)

Belanger, Kakizaki, Pukhov

The evaluation of the LKP relic abundance depends on the spectrum details and on the number of KK levels included in the calculation (eg level 2 resonances, level 2 particles in the final state, etc) Electroweak symmetry breaking effects are also important.

*Matsumoto, Senami '05; Kong, Matchev '05
Brunel, Kribs '05; Belanger, Kakizaki, Pukhov '10*

.....

Planck/WMAP set bound from above to DM scale: if DM were heavier it would lead to the Universe having a measurable positive curvature

$$1/R < 1.6 \text{ TeV}$$

The role of the 2nd level of KK excitation

Processes important for calculating DM relic abundance...

Self-annihilation

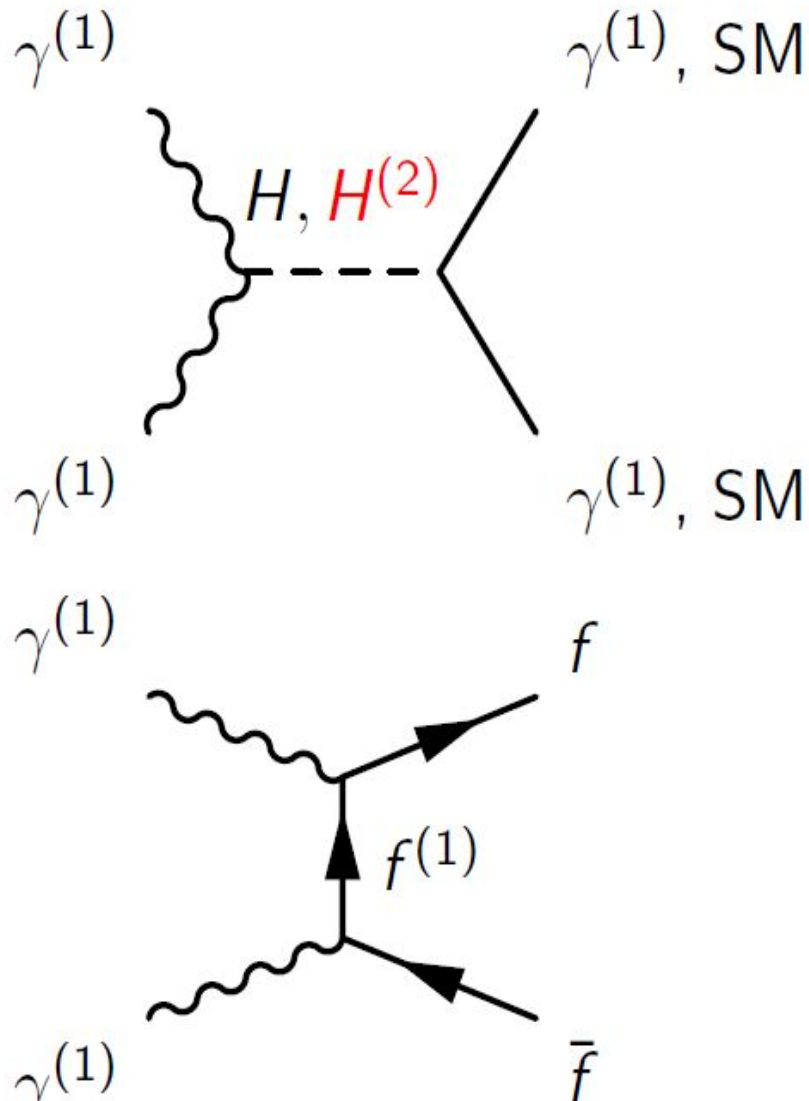

Co-annihilation

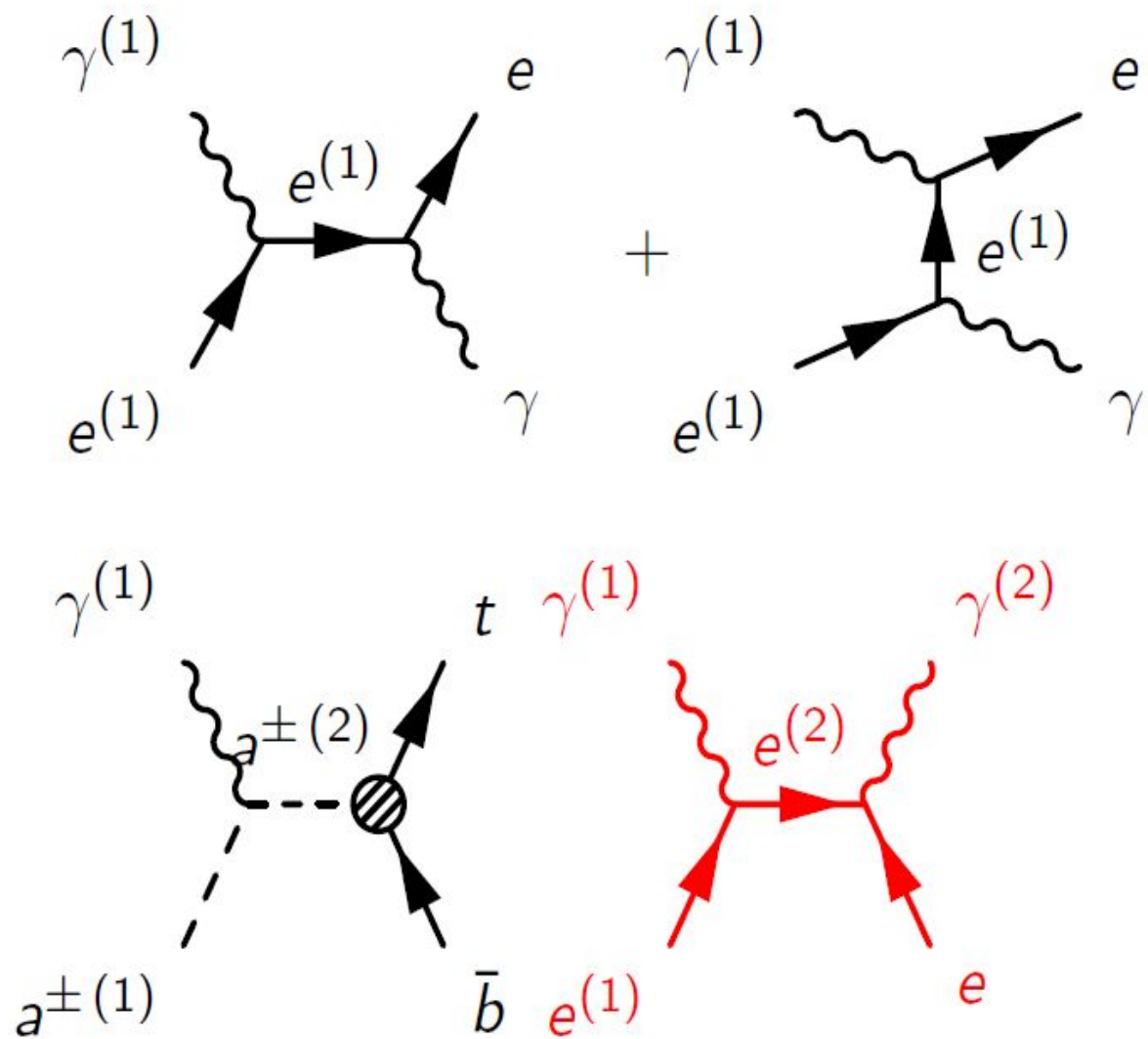

The role of the 2nd level of KK excitation

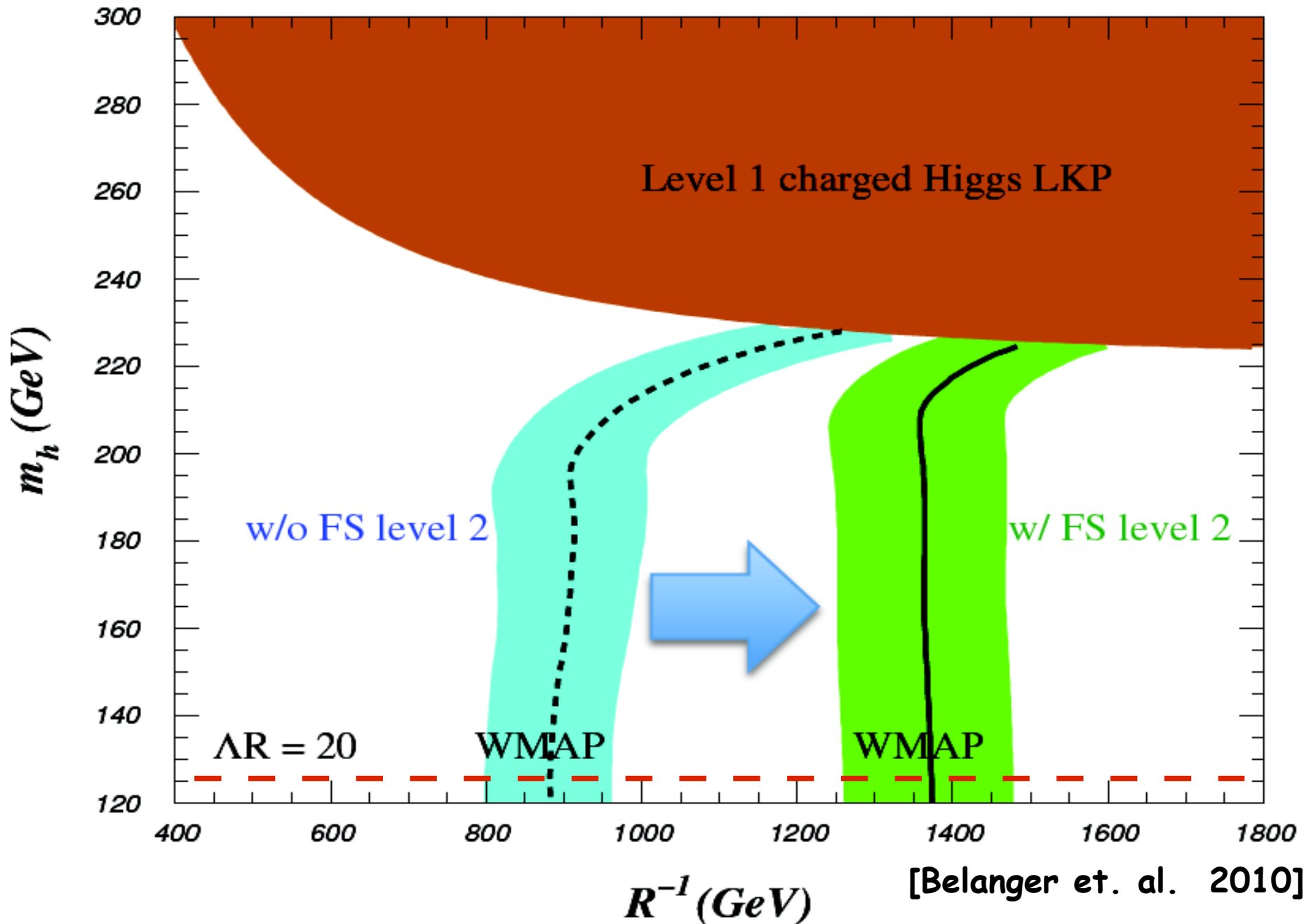

The role of the 2nd level of KK excitation

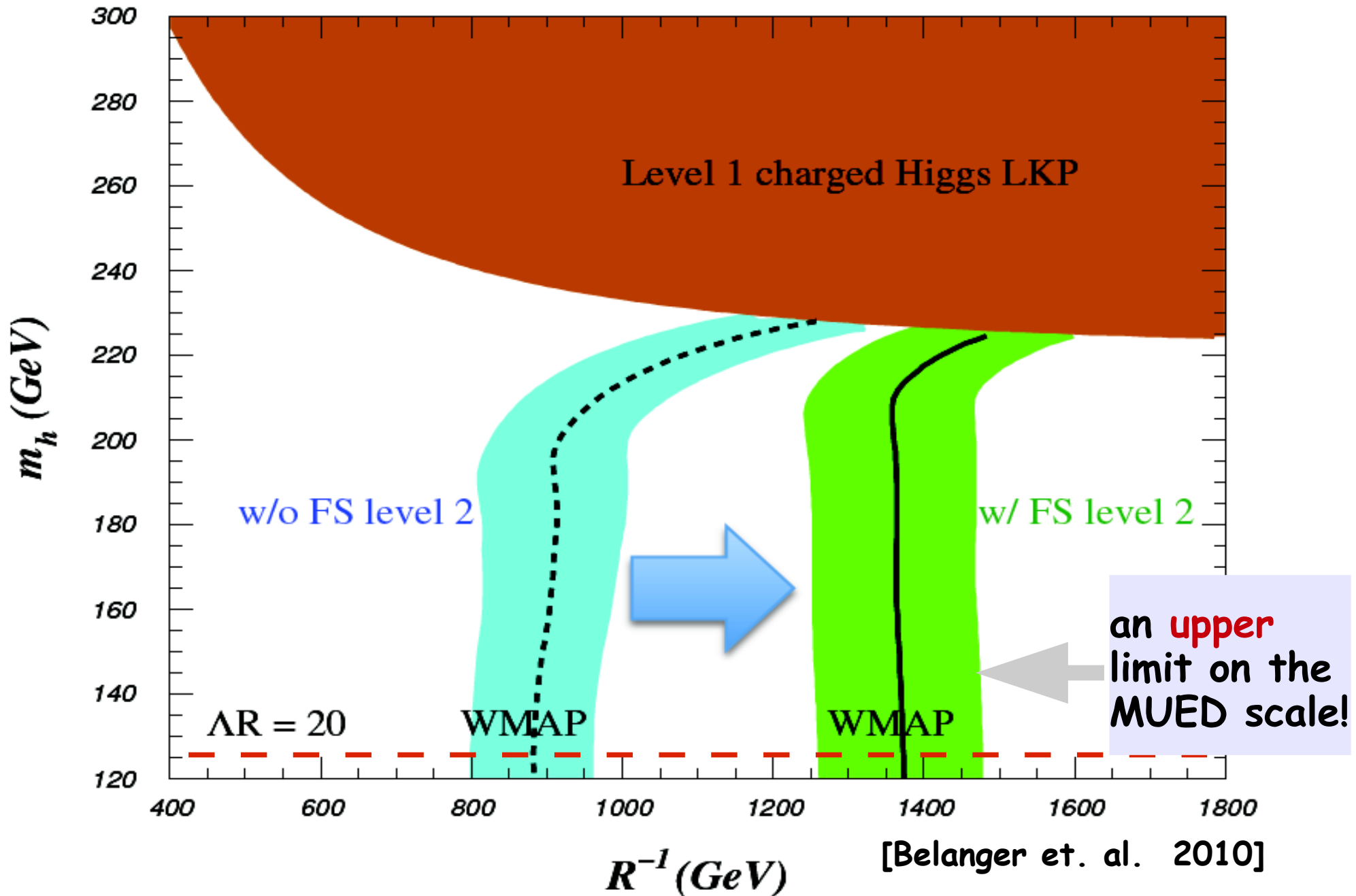

Constraints from the Higgs data

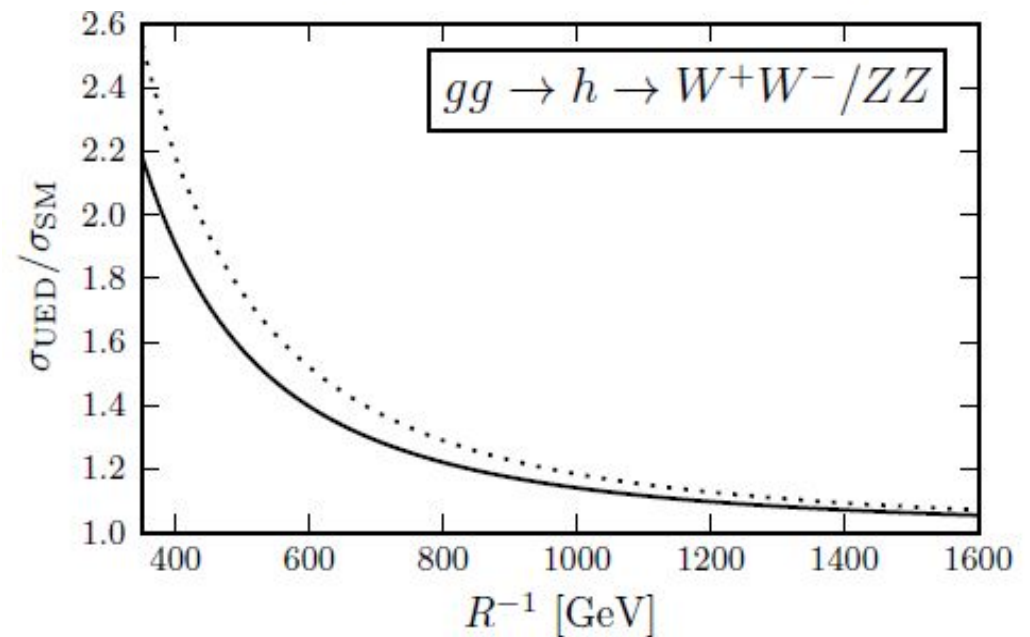
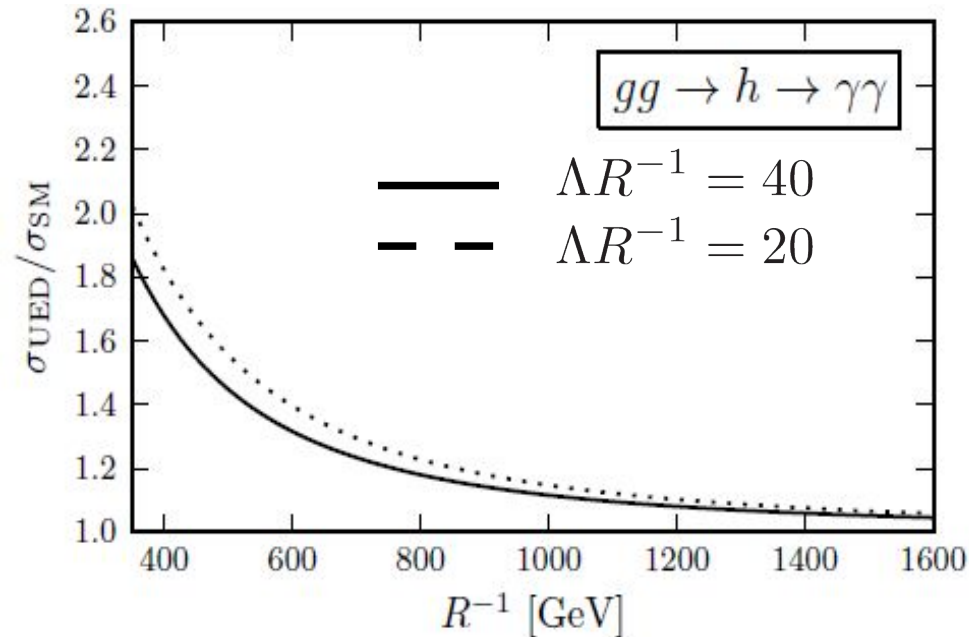
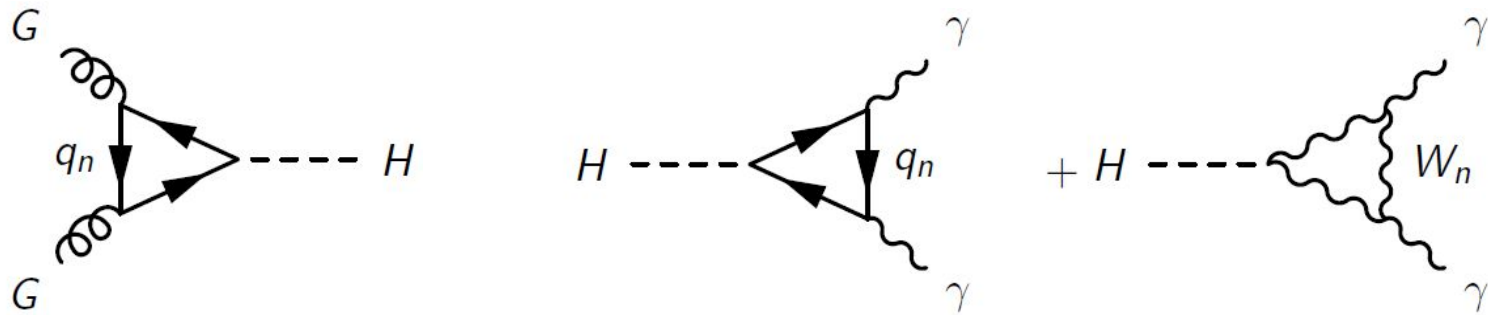

- Production is enhanced
- Decay is slightly suppressed
- Overall, the $GG \rightarrow H \rightarrow \gamma\gamma$ is enhanced

AB, Belanger, Brown, Kakizaki, Pukhov '12

Data Fit with MUED vs SM

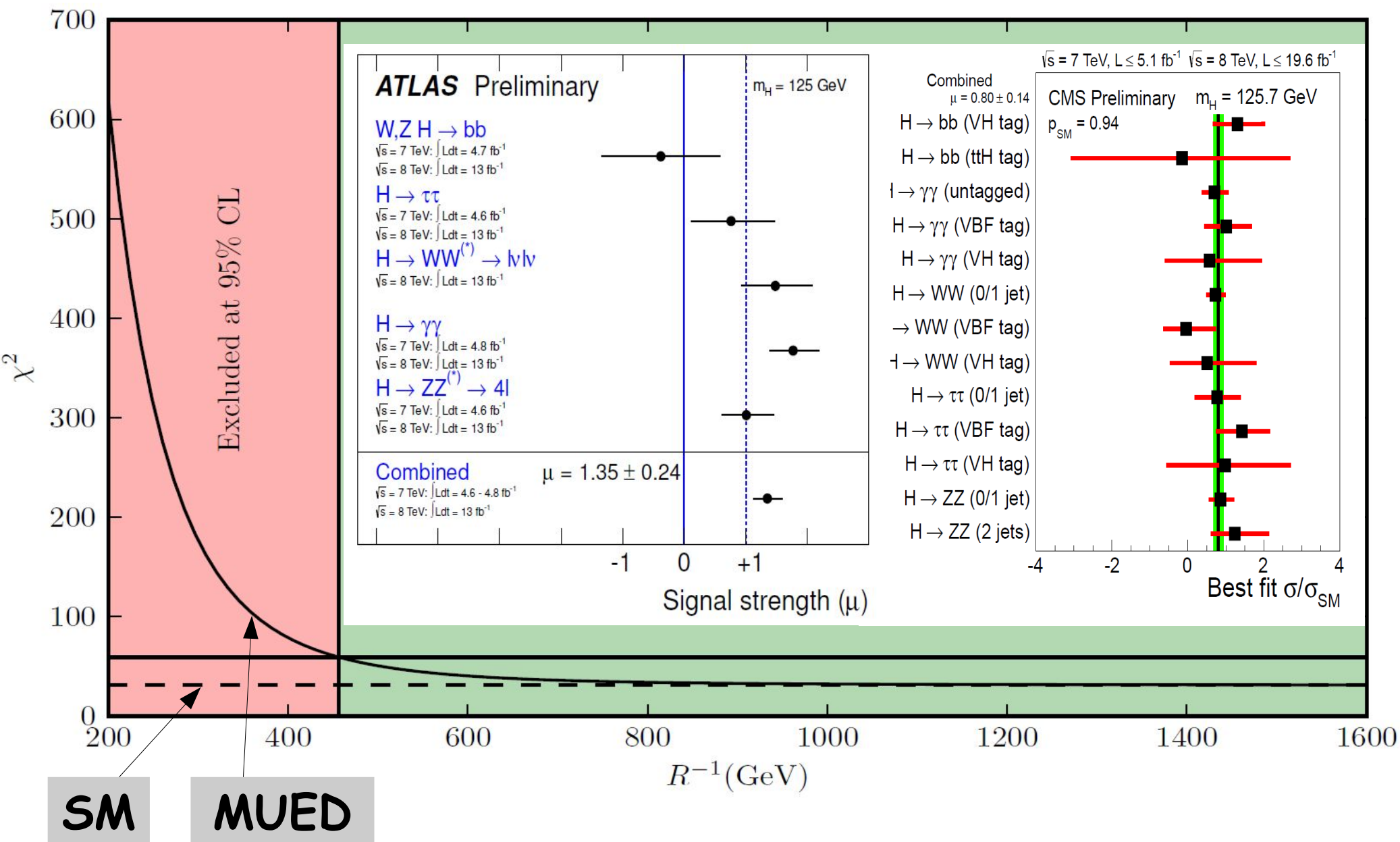

Data Fit with MUED vs SM

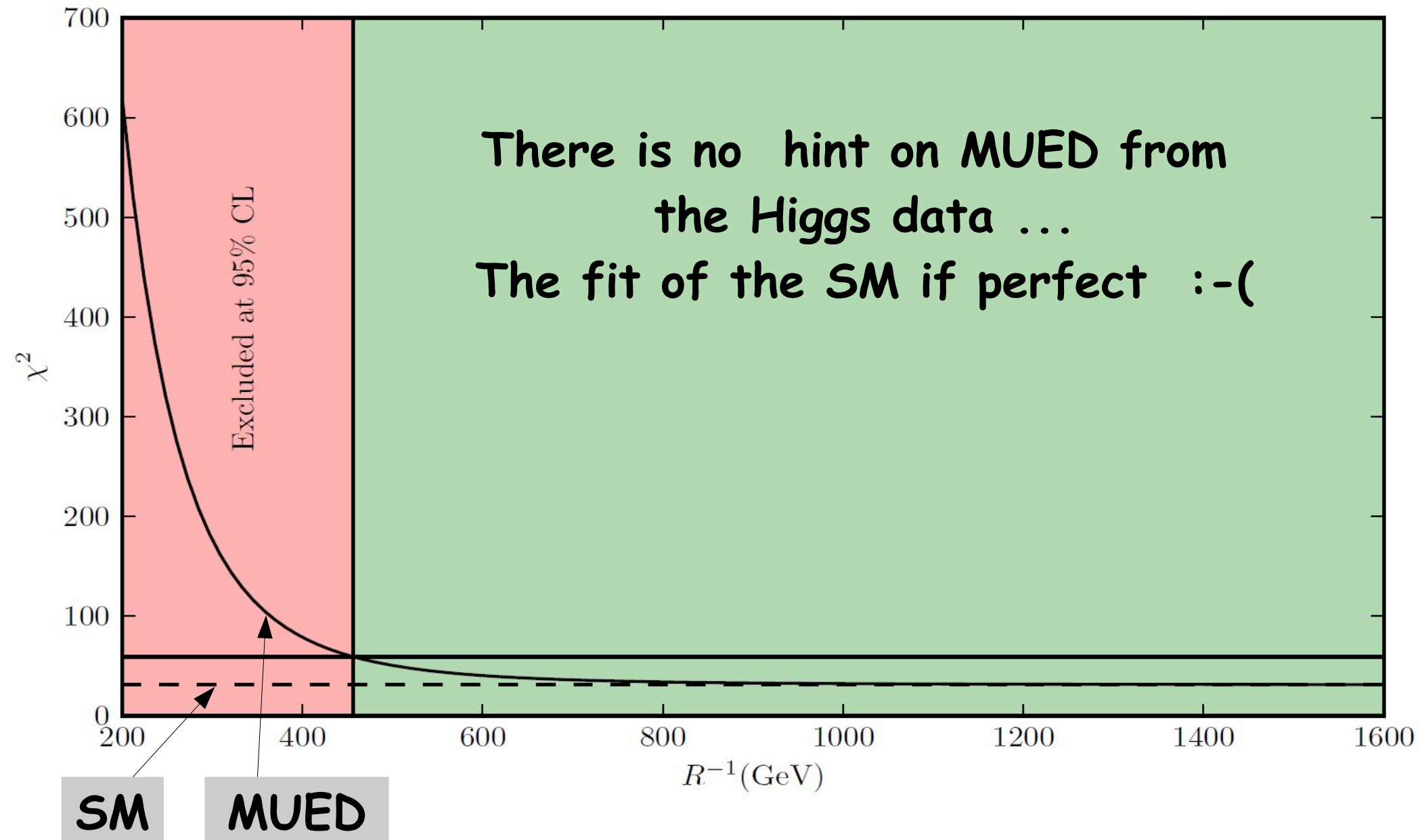

Data Fit with MUED vs SM

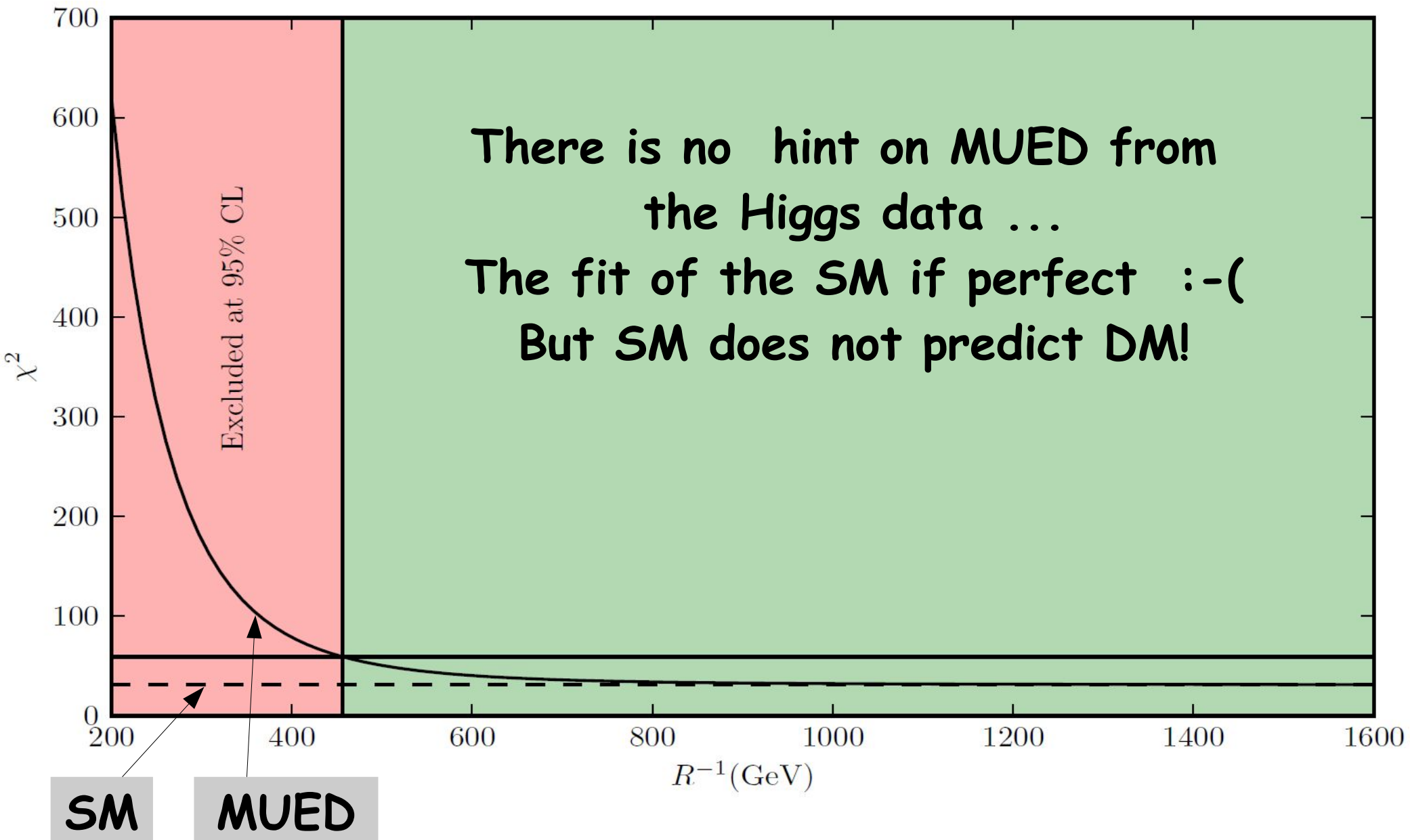

Data Fit with MUED vs SM

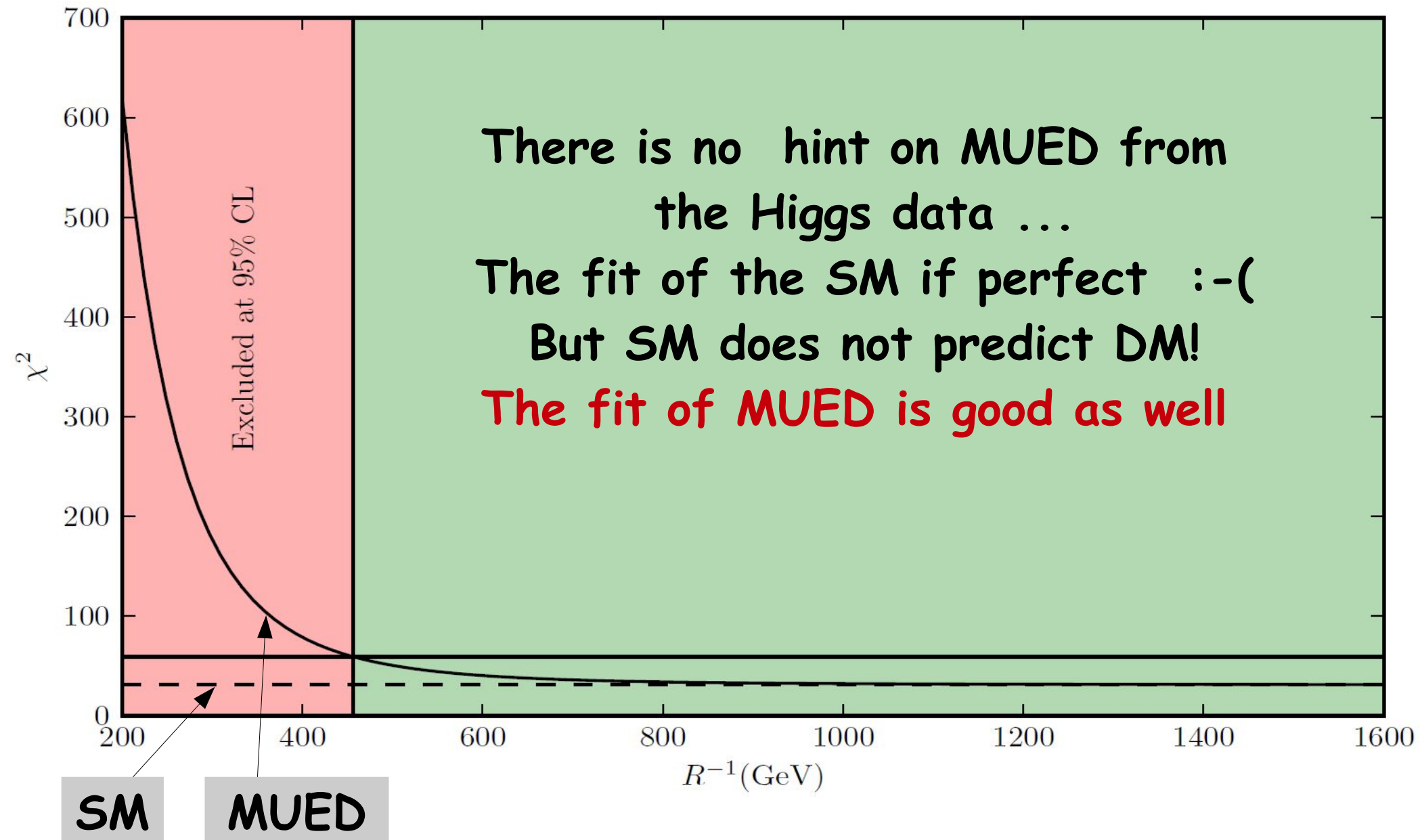

mUED: the mass spectrum defines dominant decay pattern to leptons!!!

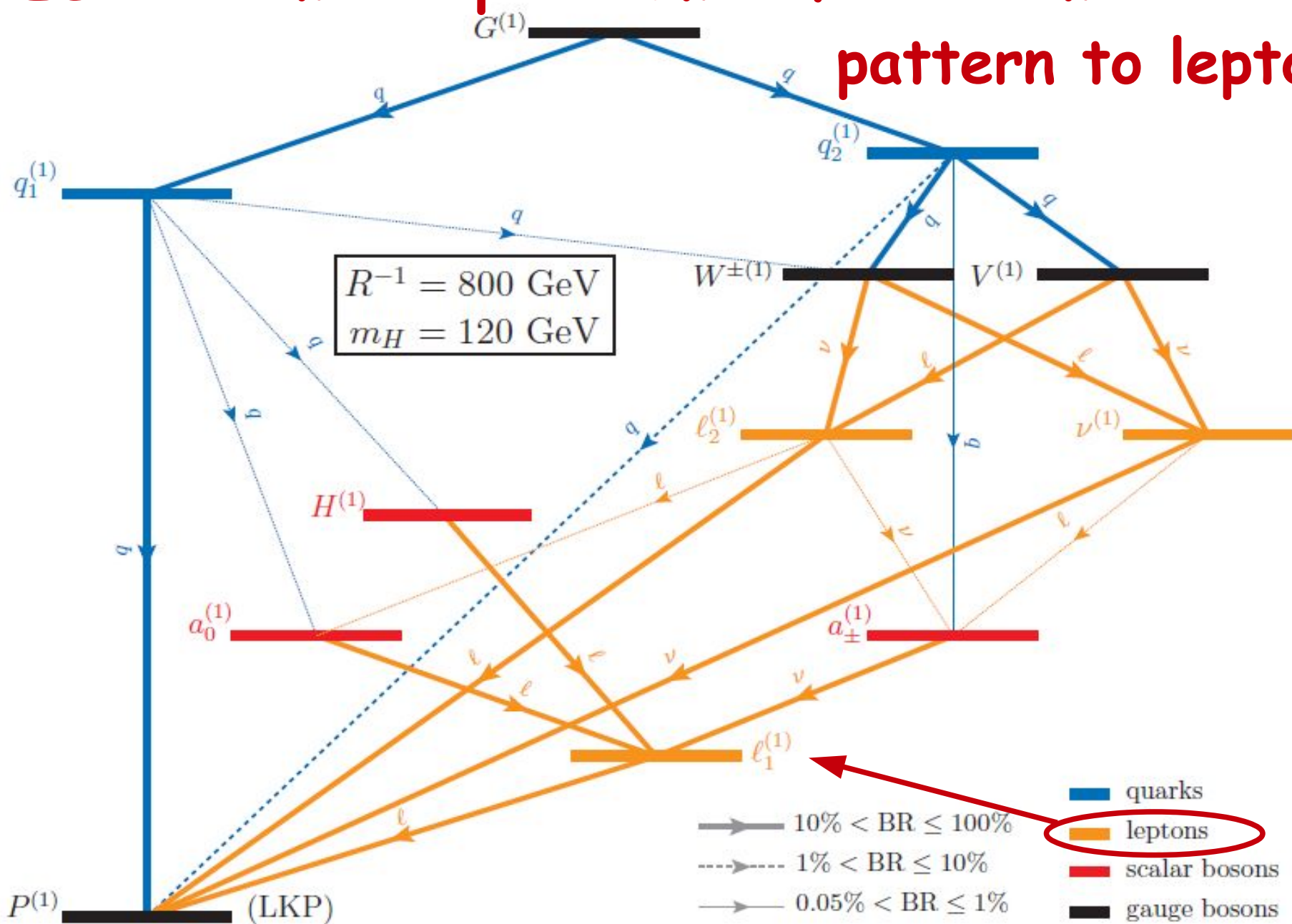

$$M_{G^{(1)}} > M_{q^{(1)}} > M_{W^{(1)}}, M_{Z^{(1)}} > M_{l^{(1)}} > M_{\gamma^{(1)}}$$

mUED: the mass spectrum defines dominant decay pattern to leptons!!!

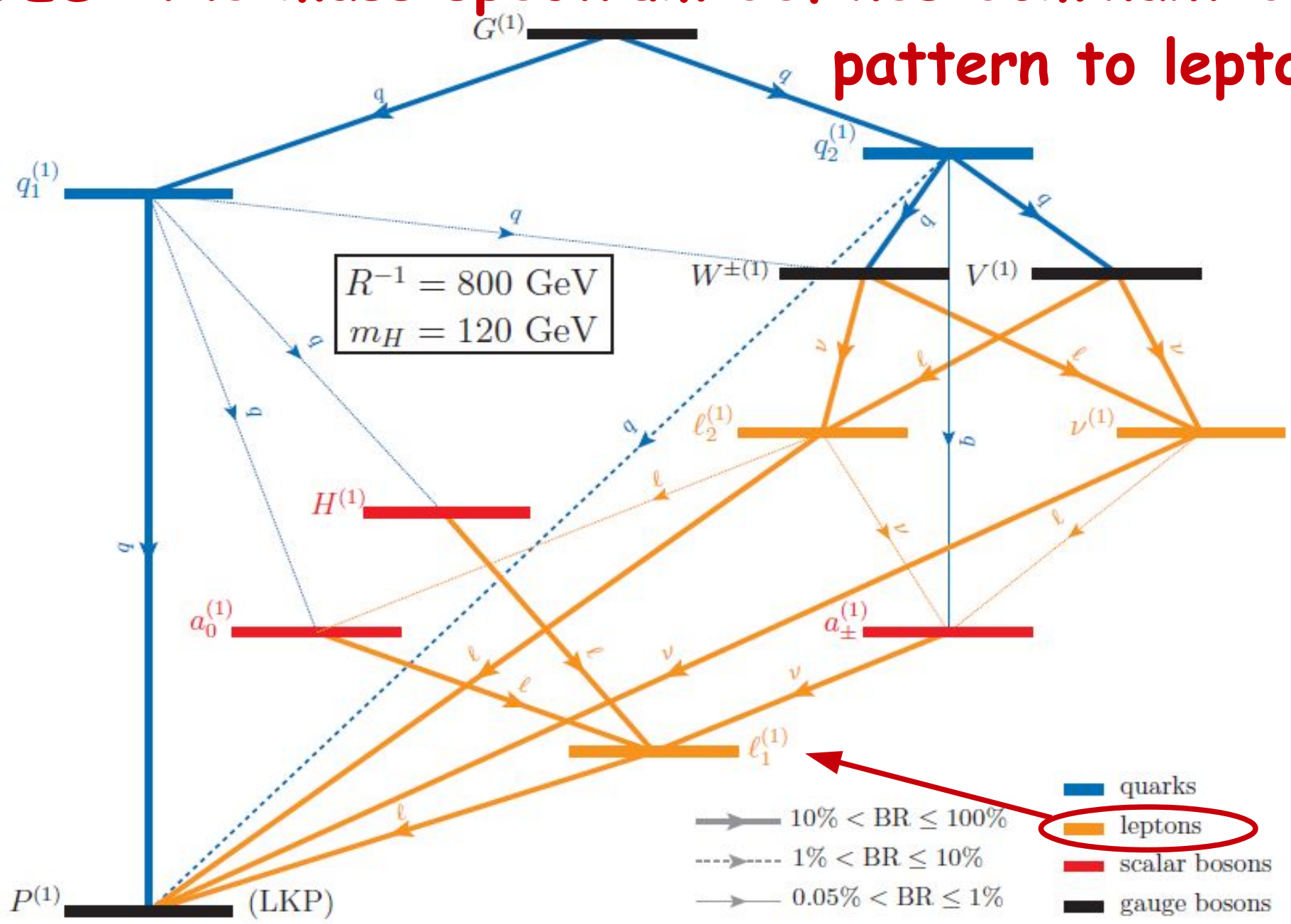

$M_{G^{(1)}} > M_{q^{(1)}} > M_{W^{(1)}}, M_{Z^{(1)}} > M_{l^{(1)}} > M_{\gamma^{(1)}}$ Can SUSY have this pattern?!

mUED collider phenomenology with leptons

AB, Brown, Moreno, Papineau'12

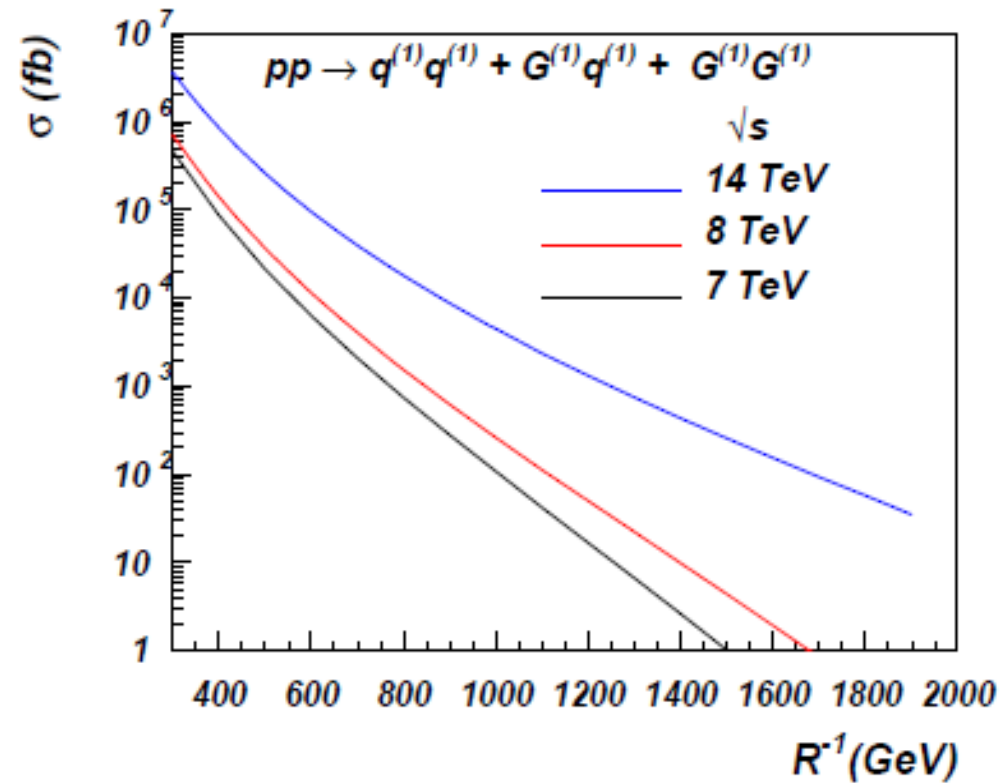
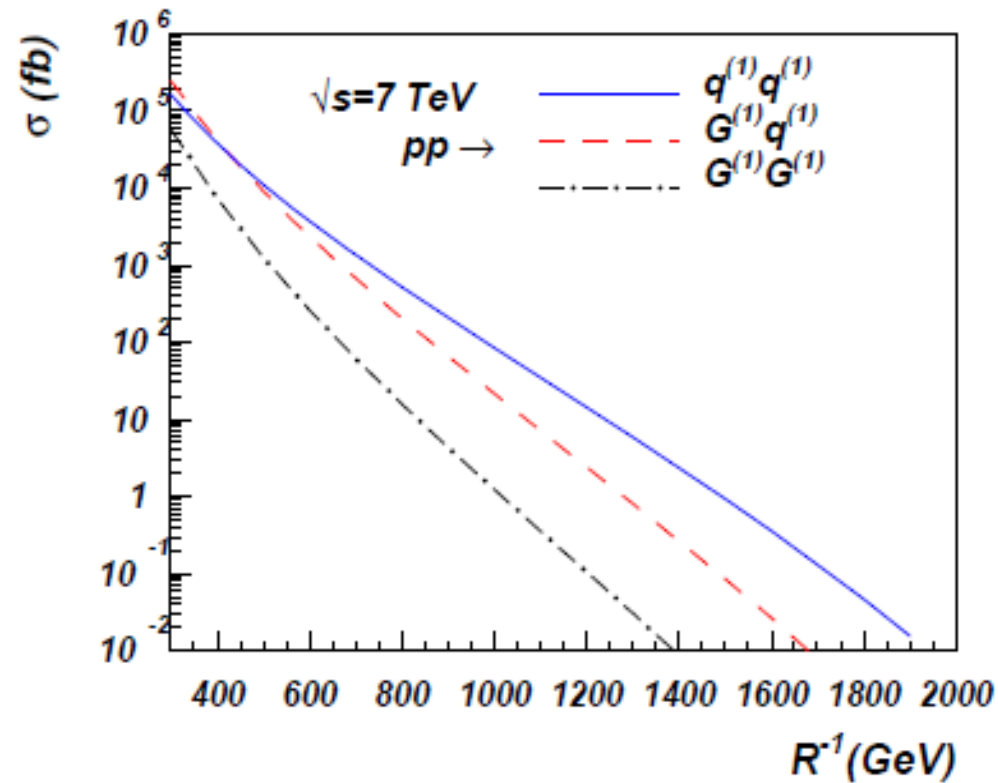

$Q^1 Q^1$ production rate is the highest

mUED collider phenomenology with leptons

Lepton multiplicity:

AB, Brown, Moreno, Papineau'12

Signal vs BG before (left) and after (right) selection cuts

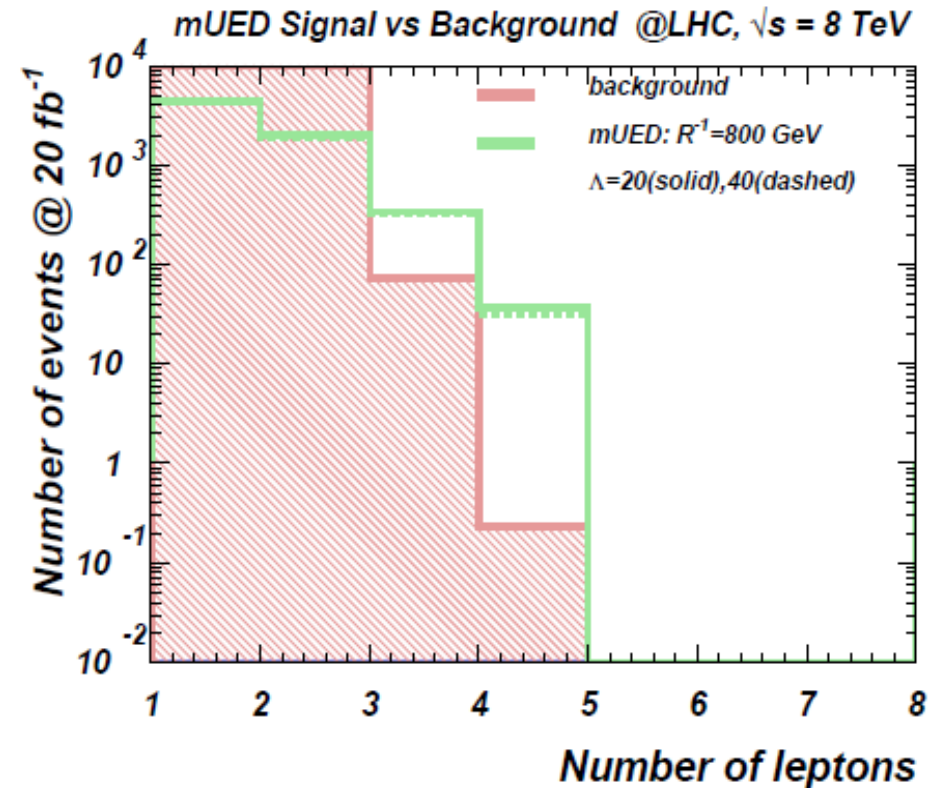
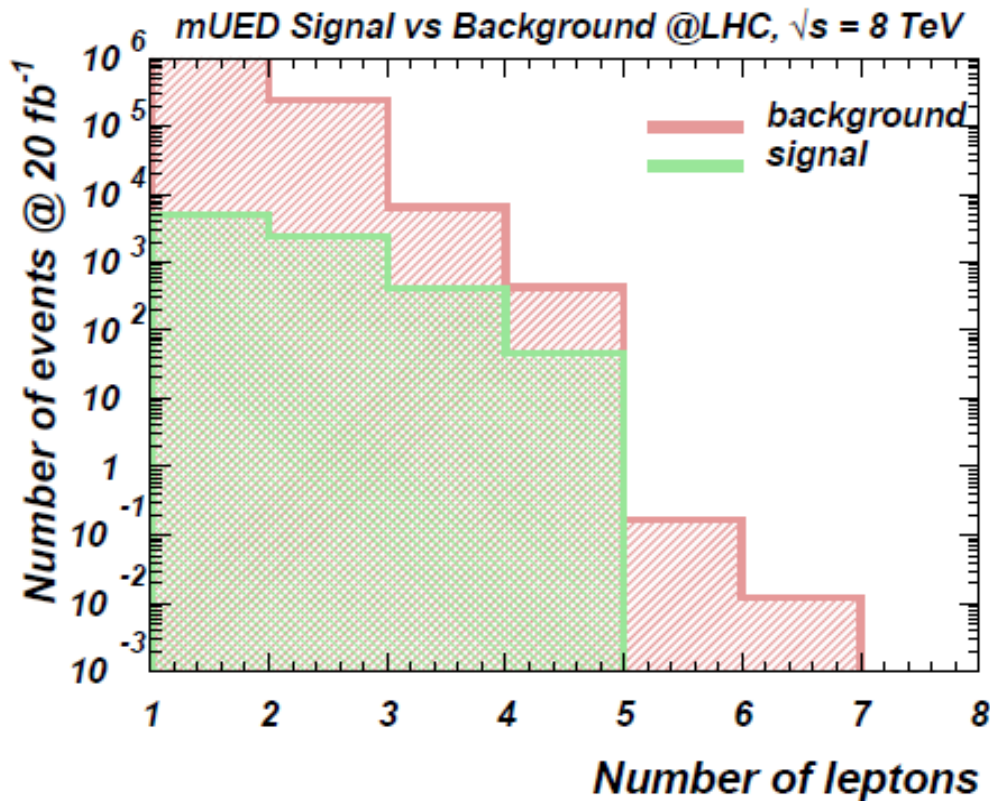

$$P_T^{\ell_1} > 20 \text{ GeV}, \quad P_T^{\ell}(\text{all}) > 10 \text{ GeV}, \quad |\eta_\ell| < 2.5, \quad \Delta R_{\ell j} = \sqrt{\Delta\phi_{\ell j}^2 + \Delta\eta_{\ell j}^2} > 0.5$$

$$|m_Z - M_{\ell\bar{\ell}}| > 10 \text{ GeV}$$

$$\cancel{P}_T > 50 \text{ GeV}$$

$$P_T^{\ell_1} < 100 \text{ GeV}; \quad P_T^{\ell_2} < 70 \text{ GeV}; \quad P_T^{\ell_3} < 50 \text{ GeV}$$

$$M_{\text{eff}} > R^{-1}/5 \quad M_{\text{eff}} = \cancel{P}_T + \sum_{\ell,j} P_T$$

Selection/Analysis cuts

mUED collider phenomenology with leptons

AB, Brown, Moreno, Papineau'12

LHC @ 8 TeV: MUED reach for 3-lepton signature

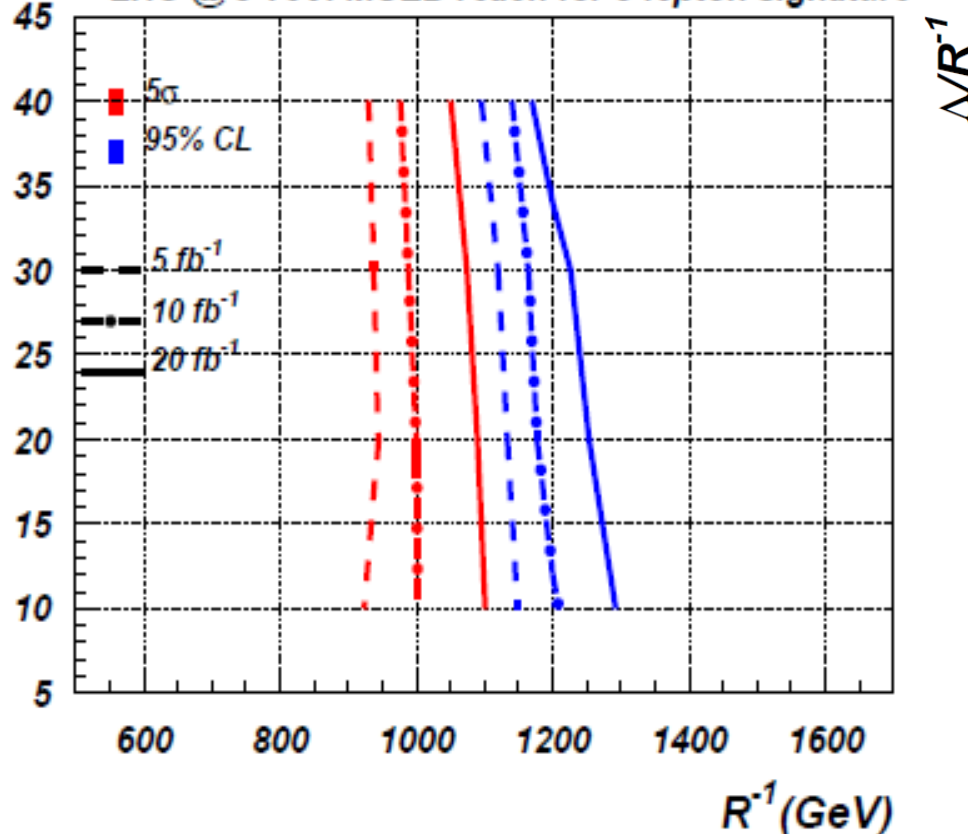

LHC@14TeV: mUED reach for 3-lepton signature

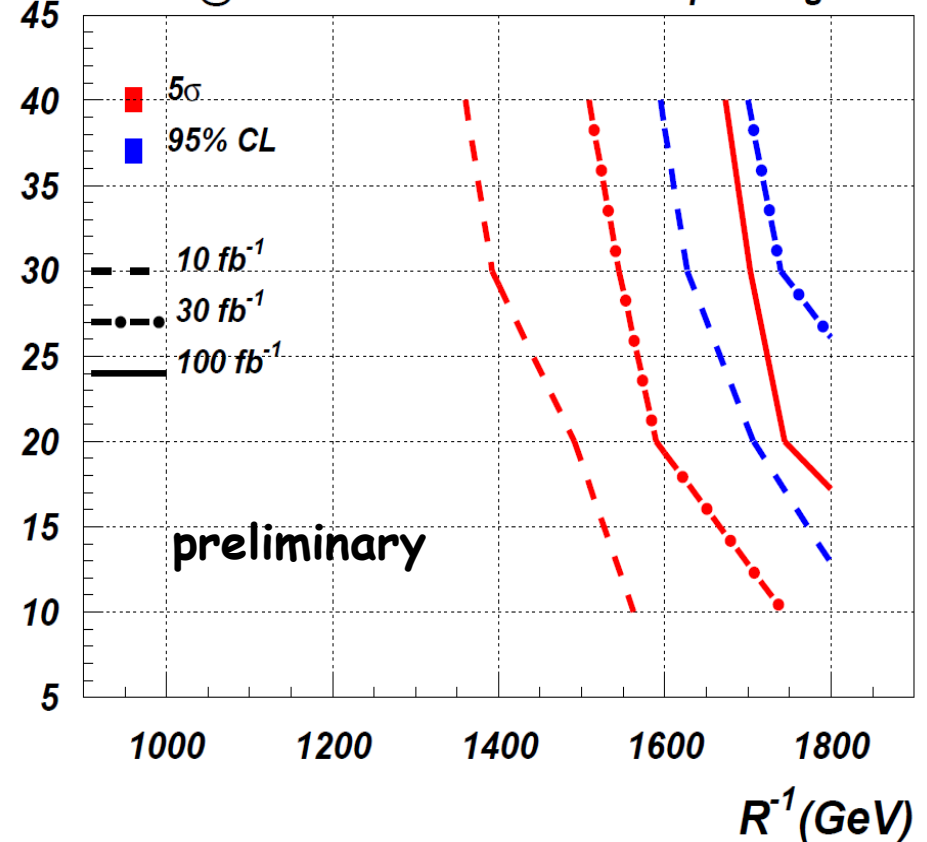

- Small mass gap (as compared to MSSM) – much lower missing PT
- Quite a few PHENO papers, but there is only one (ATLAS) dedicated study
the projected limit from this study: $R^{-1} > 1.2\text{--}1.3\text{ TeV}$
- 3-lepton signature – is very promising:
LHC@13/14 will eventually discover or close MUED!

First Results from Atlas!

- Di-muon channel
- Herwig++ for signal
- Limits are stronger than from loop-induced processes:
- **800-900 GeV vs 600 GeV** based on dilepton signature
- But from **trilepton signature** we expect the limit to be **~1.2 TeV**
- Because the reducible and irreducible BGs are much higher for 2-lepton signature, while signal difference is small

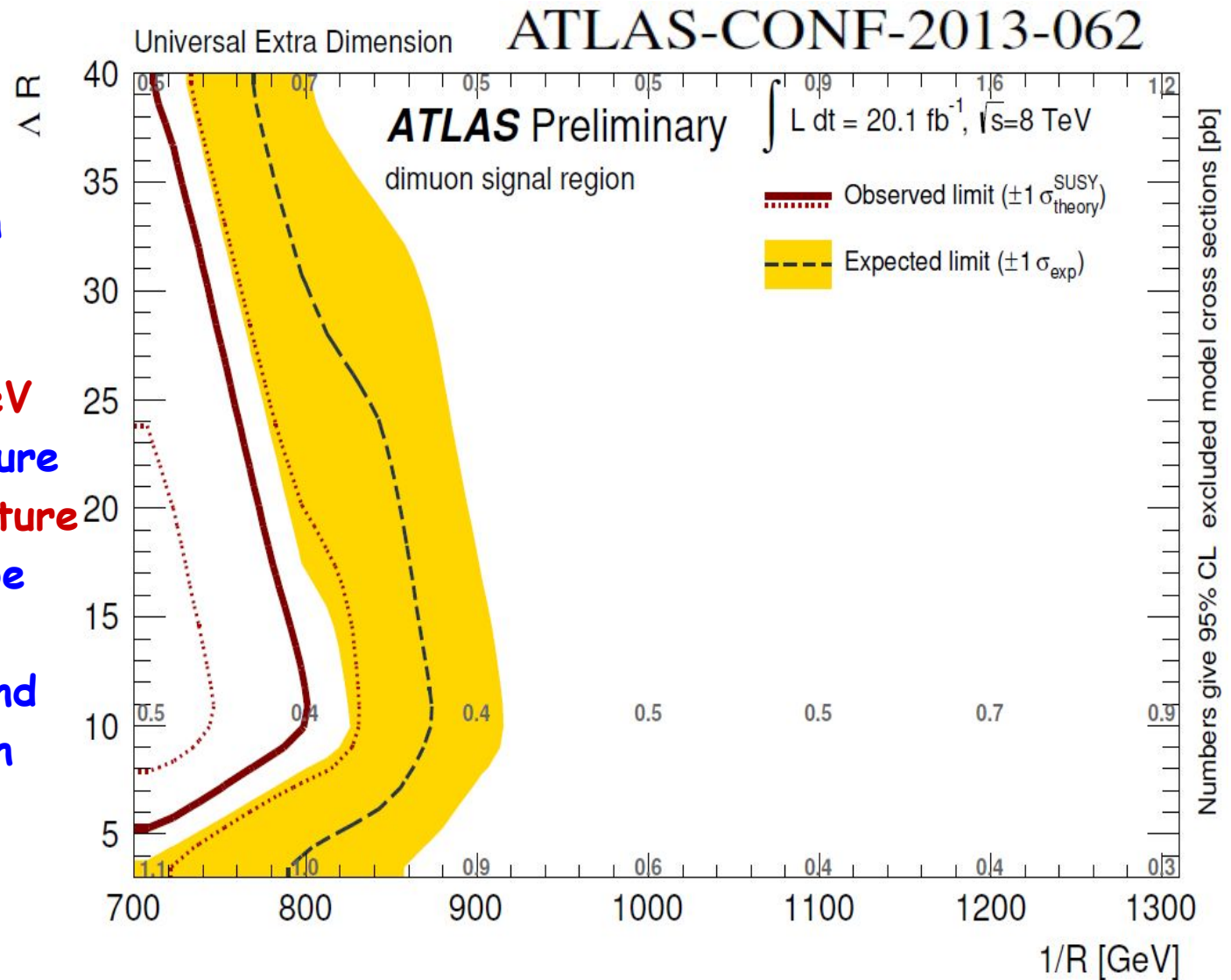

UED summary

- UED are limited from above by DM relic abundance and from below by the LHC searches
LHC and DM search experiments provide an important test:
LHC@13 TeV will discover or exclude the complete parameter space for 5 & 6D UED
- There is only one (ATLAS) limit on MUED from di-muon signature only!
3-lepton signal is very promising for MUED at the LHC.
- Consistent MUED with EWSB and loop-corrections is implemented into LanHEP and publicly available at HEPMDB [CalcHEP and UFO(Madgraph5) formats are available].
It is ready to be used by experimentalists and theorists!

Rundal Sundrum ("warp scenario") [1999]

- a warped geometry is described by a metric of the form

$$ds^2 = e^{2A(y)} dx_4^2 + g_{mn}(y) dy^m dy^n$$

- where $dx_4^2 = \eta_{\mu\nu} dx^\mu dx^\nu$ is the 4D Minkowski line element
- y^n parameterise the XD of space-time, with metric g_{mn}
- The function e^A is the warp factor, defining 4D massscales
- gravity propagates in the compact & non-compact directions
- The 4D Newton's constant is related to the the D dimensional one by

$$G_N^{-1} = G_D^{-1} \int d^{D-4}y \sqrt{g} e^{2A}$$

- 4D Planck scale M_D exponentially suppressed by the warp factor

$$M_D = M_{PL} \exp(-\pi k R)$$

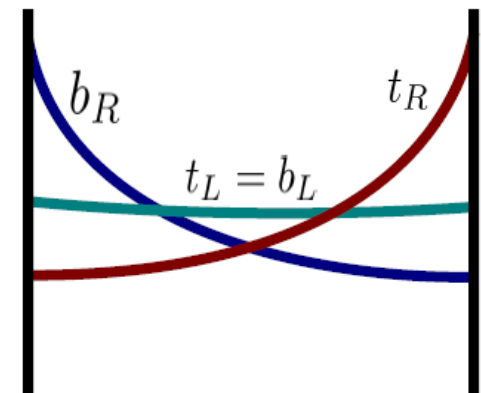

Planck (UV) TeV(IR)

where k, R are related to $A(y)$

Technicolor

EWSB from Technicolor: (Weinberg 78, Susskind 78)

- 1 In the SM without a Higgs, QCD breaks the EW symmetry:
(Farhi & Susskind 81)

$$\langle \bar{u}_L u_R + \bar{d}_L d_R \rangle \neq 0 \quad \rightarrow \quad M_W = \frac{gf_\pi}{2} .$$

- 2 Consider a new strongly interacting gauge theory with $F_\Pi = v_{EW} = 246 \text{ GeV}$.
- 3 Let the electroweak gauge group be a subgroup of the chiral symmetry group.

Left-handed technifermions in weak doublets,
right-handed in weak singlets

$$Q_L^a = \begin{pmatrix} U^a \\ D^a \end{pmatrix}_L, \quad Q_R^a = (U_R^a, D_R^a), \\ a = 1, \dots, d(\mathcal{R}_{TC})$$

At the weak scale, the technifermions condense and break the weak symmetries correctly to EM:

$$\langle \bar{U}_L U_R + \bar{D}_L D_R \rangle \neq 0$$

In QCD at a scale Λ_{QCD} the interaction becomes strong and the quarks form a bound state with non-zero *vev*:

$$\langle 0 | \bar{u}_L u_R + \bar{d}_L d_R | 0 \rangle \neq 0, T_L^3 + Y_L = Y_R = Q \Rightarrow SU(2)_L \times U(1)_Y \rightarrow U(1)_{EM}$$

Redefine fields in terms of composite colorless states, like pions:

$$q = (u, d), j_{5a}^\mu = \bar{q} \gamma^\mu \gamma^5 \frac{\tau_a}{2} q = f_\pi \partial^\mu \pi_a$$

and plug in \mathcal{L}_{k-f}

$$\mathcal{L}_{k-f} \supset \frac{g}{2} f_{\pi^+} W_\mu^+ \partial^\mu \pi^+ + \frac{g}{2} f_{\pi^-} W_\mu^- \partial^\mu \pi^- + \frac{g}{2} f_{\pi^0} W_\mu^0 \partial^\mu \pi^0 + \frac{g'}{2} f_{\pi^0} B_\mu^+ \partial^\mu \pi^0$$

$$\begin{aligned}
 & \text{Diagram: } W^\pm \text{ self-energy loop} = \text{Diagram: } W^\pm + \text{Diagram: } W^\pm \text{ loop with } \pi^\pm + \dots \\
 & = \frac{1}{p^2} + \frac{1}{p^2} (gf_{\pi^\pm}/2)^2 \frac{1}{p^2} + \dots = \frac{1}{p^2 - (gf_{\pi^\pm}/2)^2}
 \end{aligned}$$

The EW bosons have acquired mass:

$$M_W^{QCD} = gf_{\pi^\pm}/2, \quad \rho = \frac{M_W^{QCD}}{\cos \theta_w M_Z^{QCD}} = 1,$$

Given the experimental value for the pion decay constant

$$f_\pi = 93 \text{ MeV} \quad \Rightarrow \quad M_W^{QCD} = 29 \text{ MeV!}$$

The effective Lagrangian expansion breaks down at

$$\Lambda_{QCD} \simeq 4\pi f_\pi = 1.2 \text{ GeV} \Rightarrow \Lambda_{TC} \simeq 4\pi v = 3 \text{ TeV}, \quad v = 246 \text{ GeV}.$$

A Technicolor (TC) model able to give the right masses to the EW gauge bosons is simply "scaled up" QCD:

$$SU(N)_{TC} \times SU(3)_C \times SU(2)_L \times U(1)_Y.$$

No fundamental scalar \Rightarrow no fine-tuning!

The mass spectrum can be estimated by multiplying the mass of QCD composite states by v/f_π .

New Strong Sector

- 1 The SM gauge group is augmented:

$$G_{SM} \rightarrow SU(3)_c \times SU(2)_W \times U(1)_Y \times G_{SD} .$$

(SD=Strong Dynamics/Technicolor)

- 2 The Higgs sector of the SM is replaced:

$$\mathcal{L}_{Higgs} \rightarrow -\frac{1}{4} F_{\mu\nu}^a F^{a\mu\nu} + i\bar{Q}_L \gamma_\mu D^\mu Q_L + i\bar{Q}_R \gamma_\mu D^\mu Q_R + \dots$$

$$\langle \bar{U}_L U_R + \bar{D}_L D_R \rangle \sim F_\Pi^3 \rightarrow M_W = \frac{g F_\pi}{2}$$

Minimal chiral symmetries: 3 GB's + Custodial + DM.

$$SU_L(2) \times SU_R(2) \times U_{TB}(1) \rightarrow SU_V(2) \times U_{TB}(1) .$$

Minimal fermion content:
2 Dirac techni-fermions in a weak doublet,
TC charge but no QCD charges:

$$Q_L^a = \begin{pmatrix} U^a \\ D^a \end{pmatrix}_L, \quad Q_R^a = (U_R^a, D_R^a),$$

$$a = 1, \dots, d(\mathcal{R}_{TC})$$

Higgs boson mass

Light TC-Higgs from radiative corrections

$$(M_H^{\text{TC}})^2 \simeq M_H^2 + 12 \kappa^2 r_t^2 m_t^2 \quad k r_t \sim \text{TC} \times \text{ETC}$$

$$F_{\Pi} = v$$

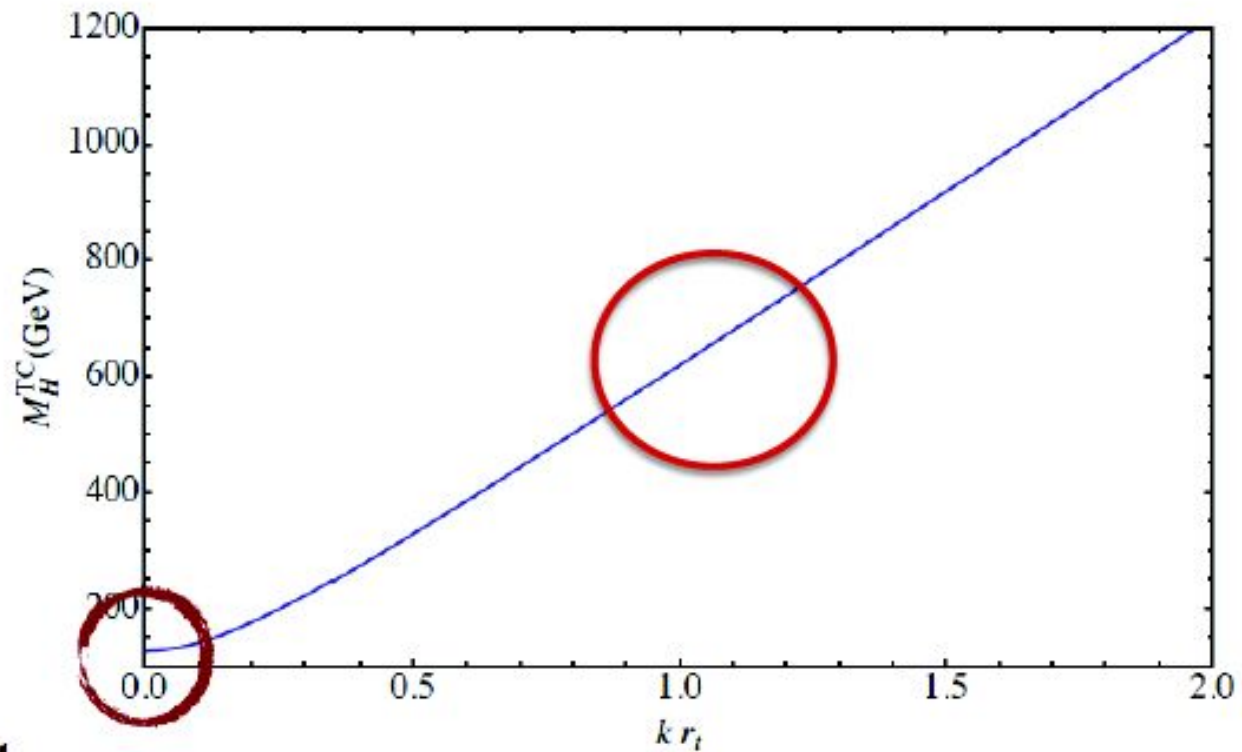

Not too light!

(Foadi, MTF & Sannino '12)

Effect correlated with the next TC resonance mass via κ and ETC via r_t

Extended Technicolor

- $SU(N_{TC})$ break the chiral symmetry of techniquarks
- their condensate breaks EW Symmetry
- Important component of the theory-
Extended Technicolor Sector - describes how SM fermions interact with the technifermion condensate to acquire mass

$$\Rightarrow \frac{g_{ETC}^2}{M_{ETC}^2} (\bar{\Psi}_L U_R) (\bar{q}_R q_L)$$

$$m_q \approx \frac{g_{ETC}^2}{M_{ETC}^2} \langle \bar{U} U \rangle_{ETC}$$

Extended Technicolor

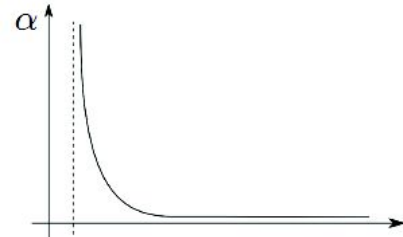

$$\langle \bar{U}U \rangle_{ETC} = \langle \bar{U}U \rangle_{TC} \exp \left(\int_{\Lambda_{TC}}^{M_{ETC}} \frac{d\mu}{\mu} \gamma_m(\mu) \right)$$

$$\langle \bar{Q}Q \rangle_{ETC} \sim \ln \left(\frac{\Lambda_{ETC}}{\Lambda_{TC}} \right) \gamma \langle \bar{Q}Q \rangle_{TC}$$

- For QCD - like running TC γ_m is small over this range, so:

$$\langle \bar{U}U \rangle_{ETC} \approx \langle \bar{U}U \rangle_{TC} \approx 4\pi F_{TC}^3$$

$$\frac{M_{ETC}}{g_{ETC}} \approx 40 \text{ TeV} \left(\frac{F_{TC}}{250 \text{ GeV}} \right)^{\frac{3}{2}} \left(\frac{100 \text{ MeV}}{m_q} \right)^{\frac{1}{2}}$$

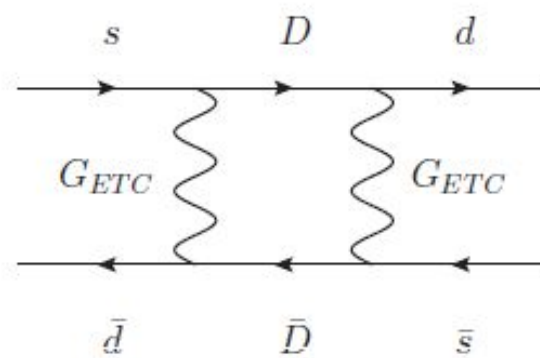
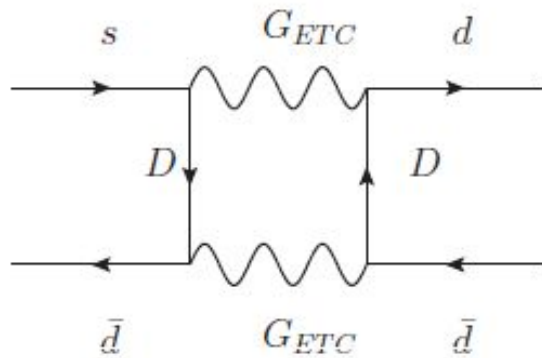

The second terms generate masses for the SM fermions, while the third terms are responsible for Flavor Changing Neutral Currents (FCNC):

$$\mathcal{L}_{\Delta S=2} = \gamma_{sd} \frac{(\bar{s}\gamma^5 d)(\bar{s}\gamma^5 d)}{\Lambda_{ETC}^2} + hc, \quad \gamma_{sd} \sim \sin^2 \theta_c \simeq 10^{-2}.$$

Extended Technicolor

$$\langle \bar{U}U \rangle_{ETC} = \langle \bar{U}U \rangle_{TC} \exp \left(\int_{\Lambda_{TC}}^{M_{ETC}} \frac{d\mu}{\mu} \gamma_m(\mu) \right)$$

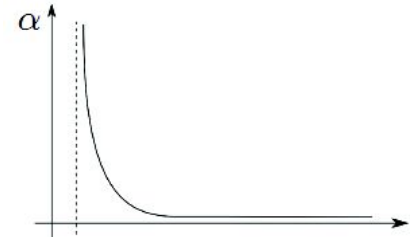

- For QCD - like running TC

γ_m is small over this range, so:

$$\langle \bar{U}U \rangle_{ETC} \approx \langle \bar{U}U \rangle_{TC} \approx 4\pi F_{TC}^3$$

$$\langle \bar{Q}Q \rangle_{ETC} \sim \ln \left(\frac{\Lambda_{ETC}}{\Lambda_{TC}} \right) \gamma \langle \bar{Q}Q \rangle_{TC}$$

$$\frac{M_{ETC}}{g_{ETC}} \approx 40 \text{ TeV} \left(\frac{F_{TC}}{250 \text{ GeV}} \right)^{\frac{3}{2}} \left(\frac{100 \text{ MeV}}{m_q} \right)^{\frac{1}{2}}$$

Measured value of the neutral kaon mass splitting determines tight bound on ETC scale:

$$\frac{\Delta m^2}{m_K^2} \simeq \gamma_{sd} \frac{f_K^2 m_K^2}{\Lambda_{ETC}^2} \lesssim 10^{-14} \Rightarrow \Lambda_{ETC} \gtrsim 10^3 \text{ TeV.}$$

- Difficult to get masses even for s- and c-quarks: TC dynamics should be NOT like QCD. Theory should "walk" and in this case we have:

$$\langle \bar{Q}Q \rangle_{ETC} \sim \left(\frac{\Lambda_{ETC}}{\Lambda_{TC}} \right) \gamma(\alpha^*) \langle \bar{Q}Q \rangle_{TC}$$

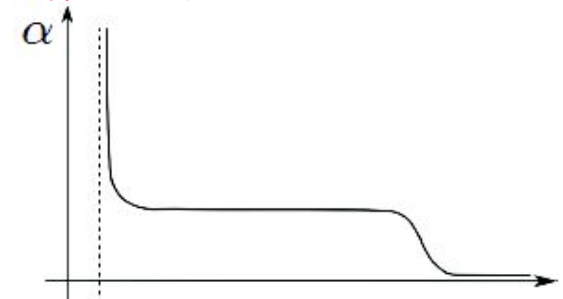

Holdom 81; Appelquist, Wijewardhana 86

Enhanced SM fermion masses and suppressed FCNC

“Near conformal” regions for $SU(N)$

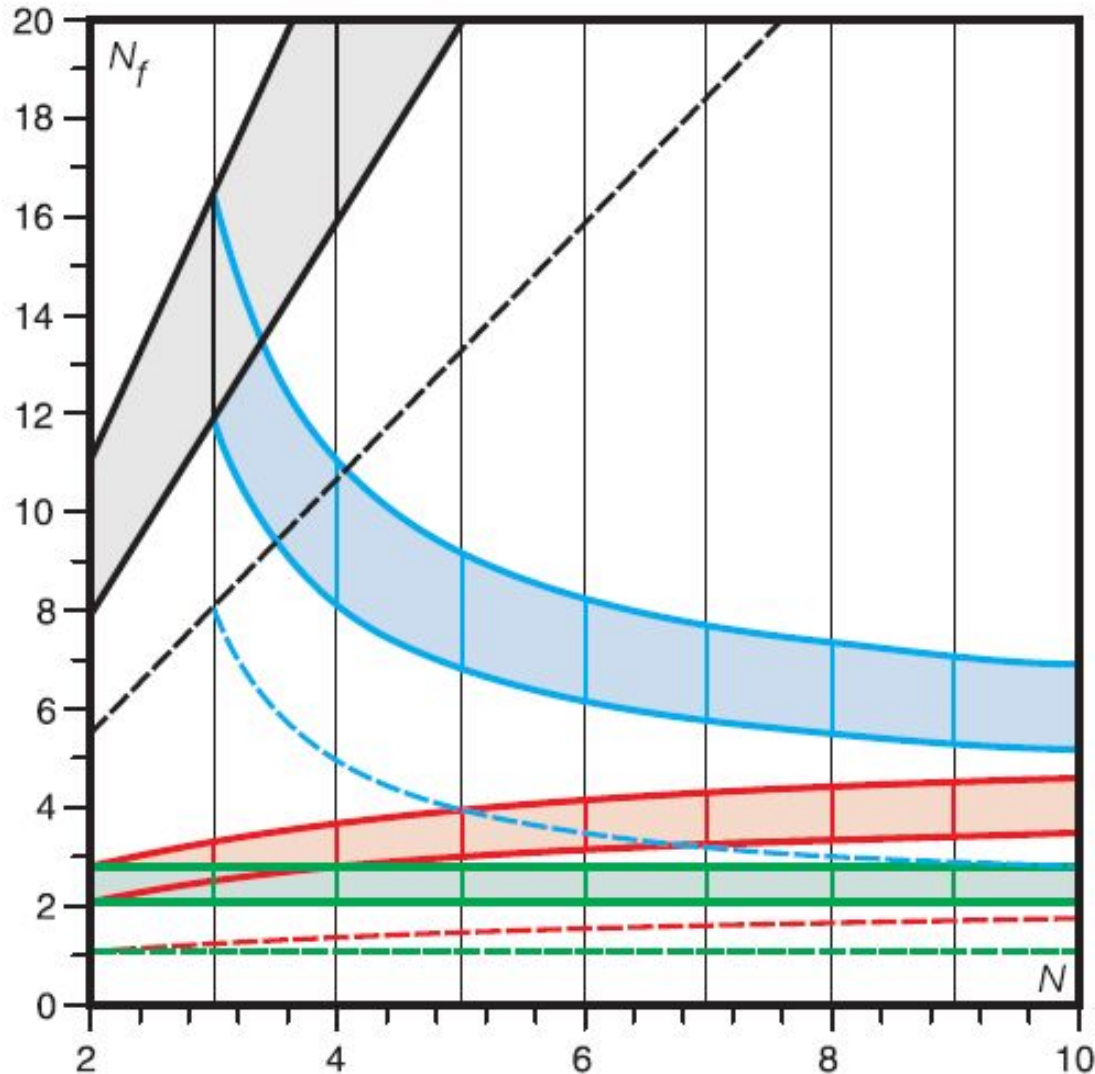

Dietrich, Tuominen, Sannino '05; Dietrich, Sannino '06

Phase diagram for theories with fermions in the:

- fundamental representation (grey)
- two-index antisymmetric (blue)
- two-index symmetric (red)
- adjoint representation (green)

The S parameter for a TC model is estimated by:

$$S_{th} \approx \frac{1}{6\pi} \frac{N_f}{2} d(\mathbf{R}),$$

$$12\pi S_{exp} \leq 6 \text{ @ } 95\%$$

SM Higgs vs Technicolor

- simple and economical
- GIM mechanism, no FCNC problems, EW precision data are OK for preferably light Higgs
- SM is established, perfectly describes data
- fine-tuning and naturalness problem; triviality problem
- there is no example of fundamental scalar
- Scalar potential parameters and yukawa couplings are inputs

- complicated at the eff theory level
- FCNC constraints requires walking, potential tension with EW precision data
- no viable ETC model suggested yet, work in progress
- no fine-tuning, the scale is dynamically generated
- Superconductivity and QCD are examples of dynamical symmetry breaking
- parameters of low-energy effective theory are derived once underlying ETC is constructed

Walking TC @the LHC

EFT for strong dynamics @ LHC

$$SU_L(2) \times SU_R(2) \times U_{TB}(1) \rightarrow SU_V(2) \times U_{TB}(1)$$

Coupling structure to SM fields :

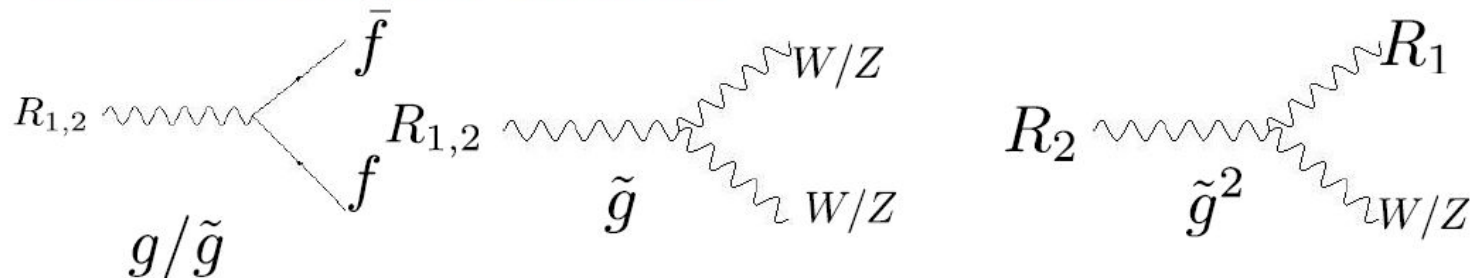

Model implementation: AB, Foadi, Frandsen, Jarvinen, Sannino, Pukhov 2009
<http://hepmdb.soton.ac.uk/hepmdb:1012.0102>

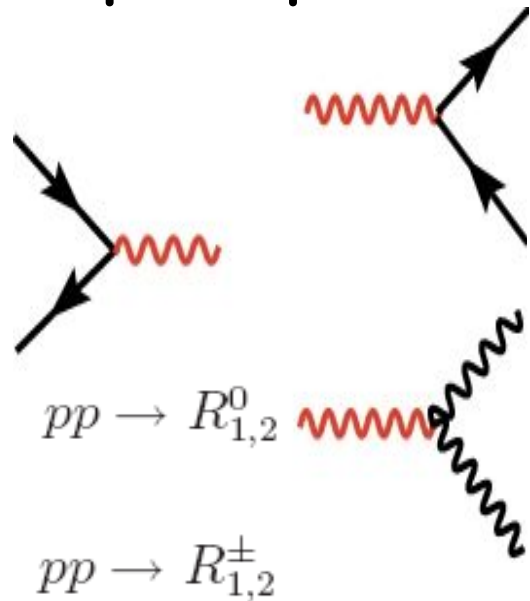

(1) $\ell^+ \ell^-$ signature from the process $pp \rightarrow R_{1,2}^0 \rightarrow \ell^+ \ell^-$

(2) $\ell + \cancel{E}_T$ signature from the process $pp \rightarrow R_{1,2}^\pm \rightarrow \ell^\pm \nu$

(3) $3\ell + \cancel{E}_T$ signature from the process $pp \rightarrow R_{1,2}^\pm \rightarrow ZW^\pm \rightarrow 3\ell\nu$

Walking TC @the LHC

(1) $\ell^+\ell^-$ signature from the process $pp \rightarrow R_{1,2}^0 \rightarrow \ell^+\ell^-$

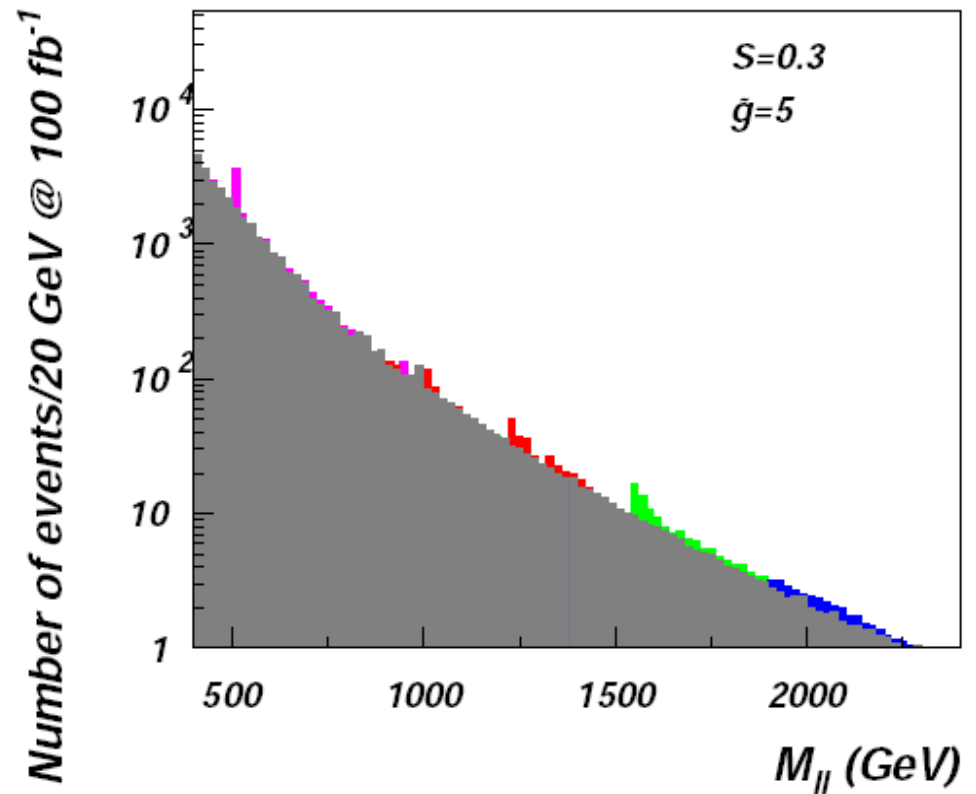
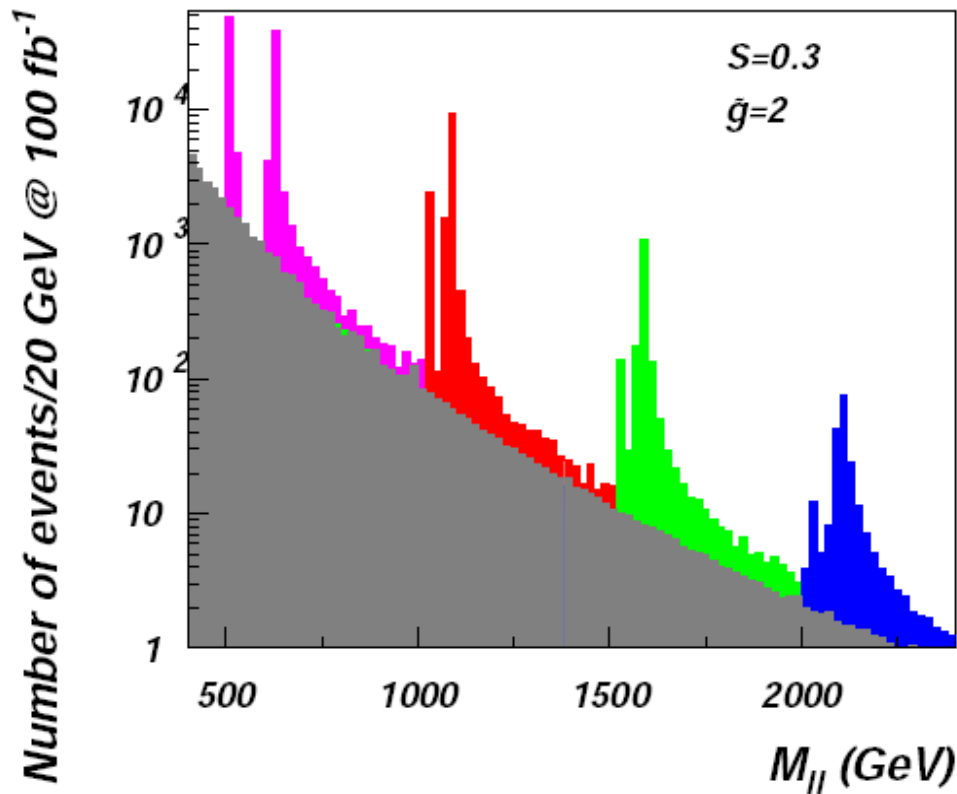

Walking TC @the LHC

complementary di-boson signature

(3) $3\ell + \cancel{E}_T$ signature from the process $pp \rightarrow R_{1,2}^\pm \rightarrow ZW^\pm \rightarrow 3\ell\nu$

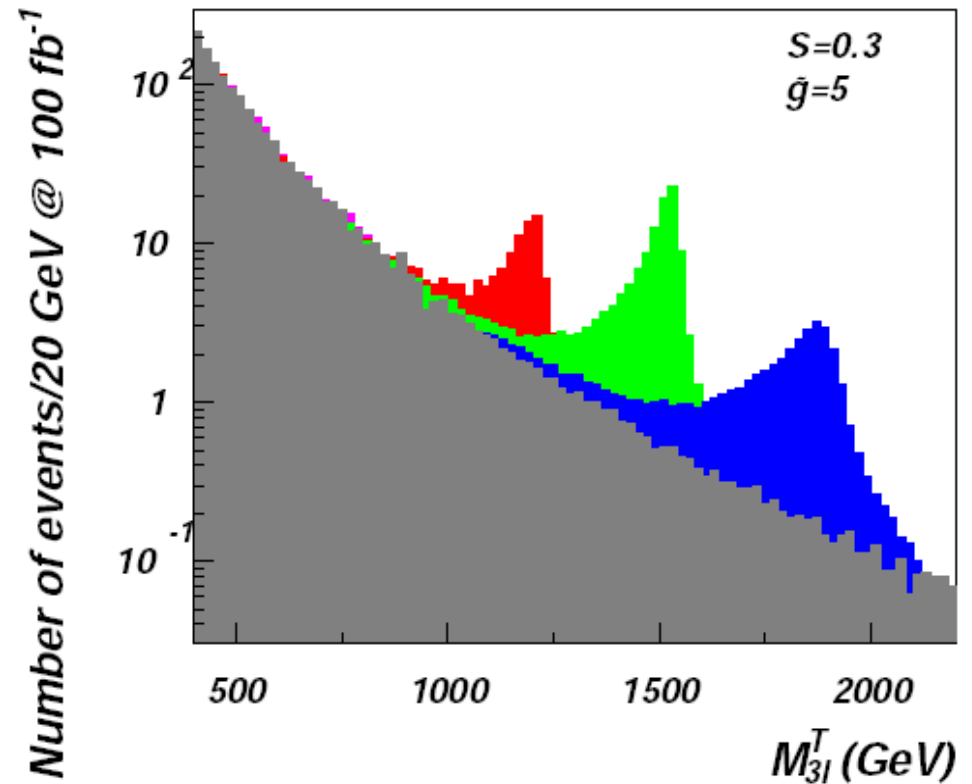
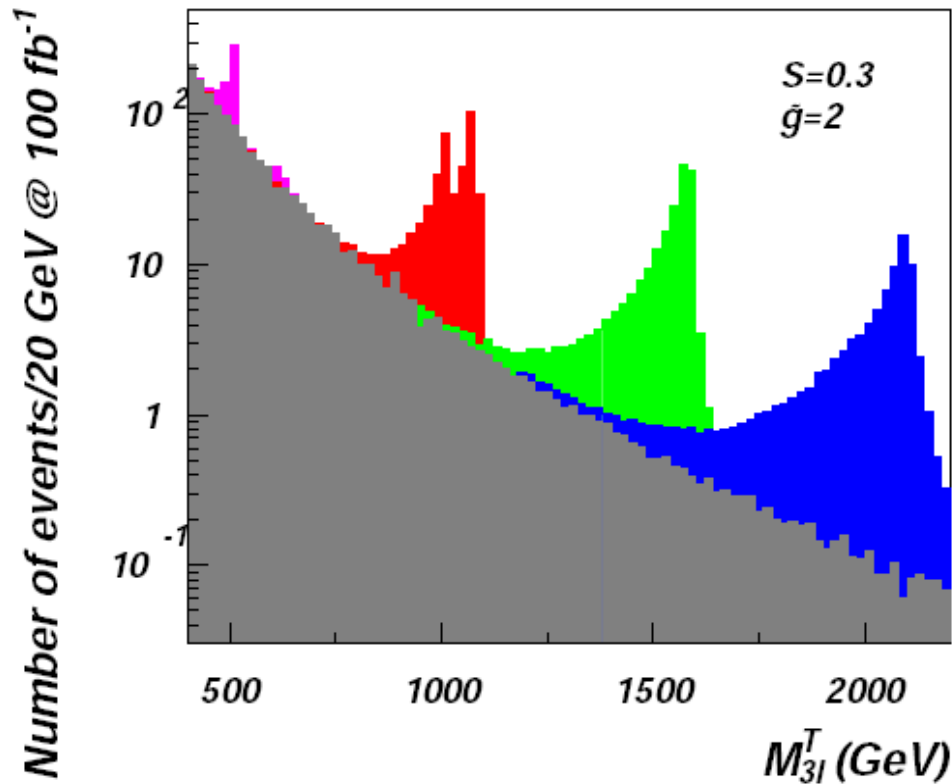

Lets take a look at di-boson invariant mass in the current data around 2 TeV ...

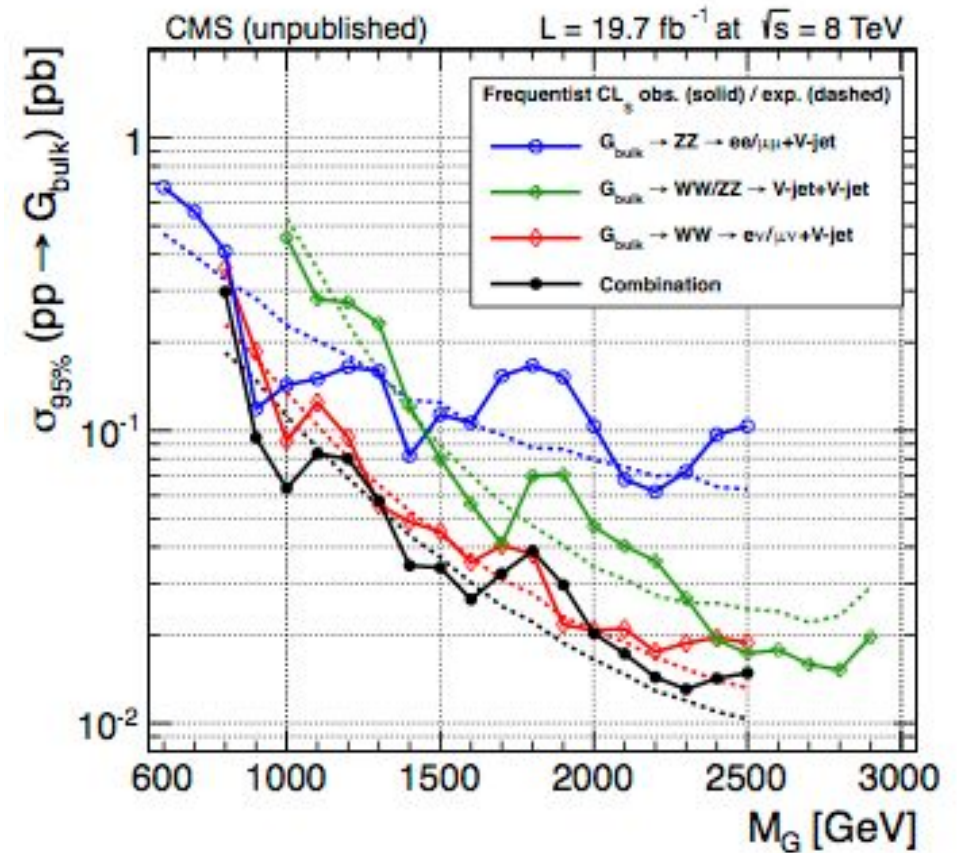
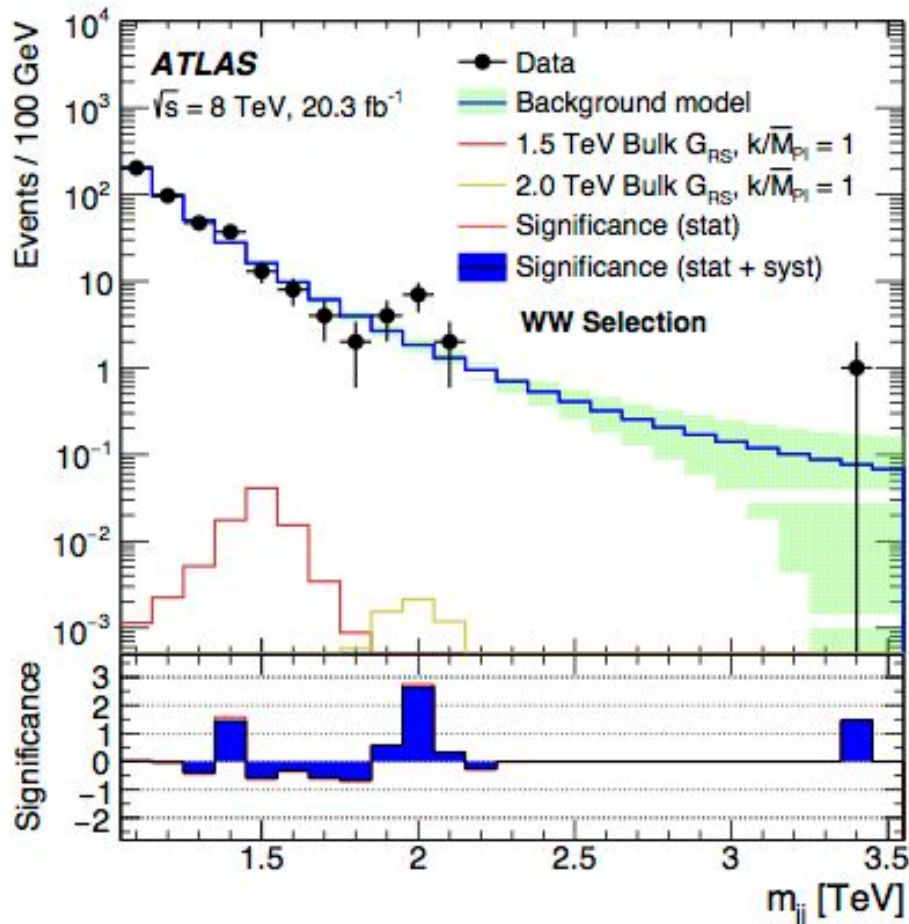

Sounds quite interesting ...

It is also intriguing to look at the correlation
in di-lepton channel ...

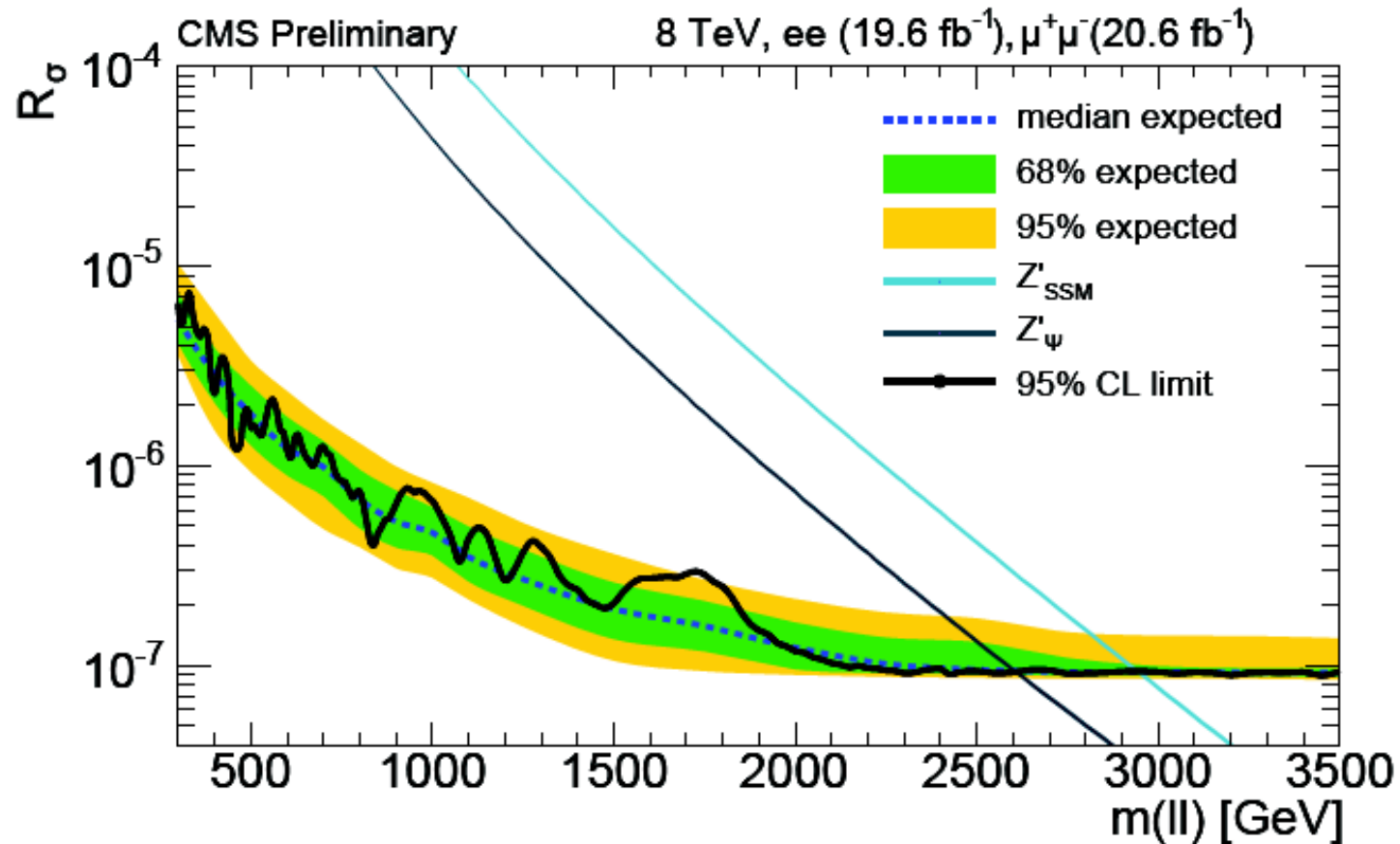

Do we think that TC is really dead?

TRIUMPH OF WEAK COUPLING

TECHNICOLOR

1977 - 2011

R. I. P.

Do we think that TC is really dead?

If title contains question, then the answer is ...

Do we think that TC is really dead?

If title contains question, then the answer is ...

NO!

Composite Higgs Unified approach

Two time-honoured extensions

■ New Strong Dynamics

- Expect new states at $4\pi f_{\text{Strong}}$?
- At least one state needs to be quite a bit lighter...*known since LEP!*
- Finding a light scalar did not change established picture *that* much...

■ Supersymmetry

- Expect new states below v_{EW} ?
- Nature likes SUSY heavy (and fine-tuned?) since LEP

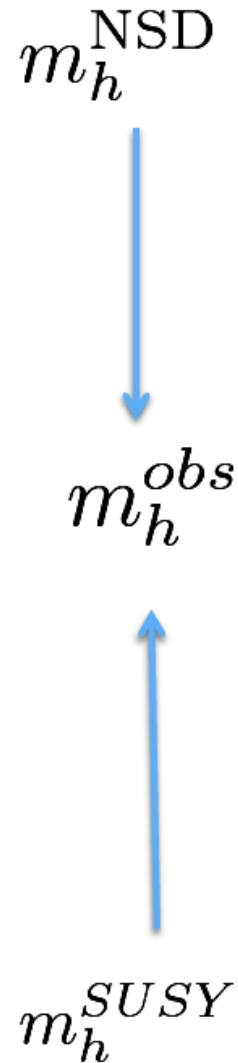

New Strong Dynamics

■ The Technicolor Composite Higgs

- 'Higgs' is the lightest scalar isospin-0 resonance of strong dynamics
- Compare with the $f_0(500)$ in QCD

■ The *Composite Higgs* Composite Higgs

- The Higgs doublet arises as goldstone bosons of global symmetry breaking
- Electroweak symmetry breaks through vacuum misalignment

m_σ^{TC}



m_h^{obs}



m_h^{CH}

Technicolor vs Composite Higgs

(Galloway, Evans, Tacchi & Luty '10
G. Cacciapaglia & F. Sannino '14)

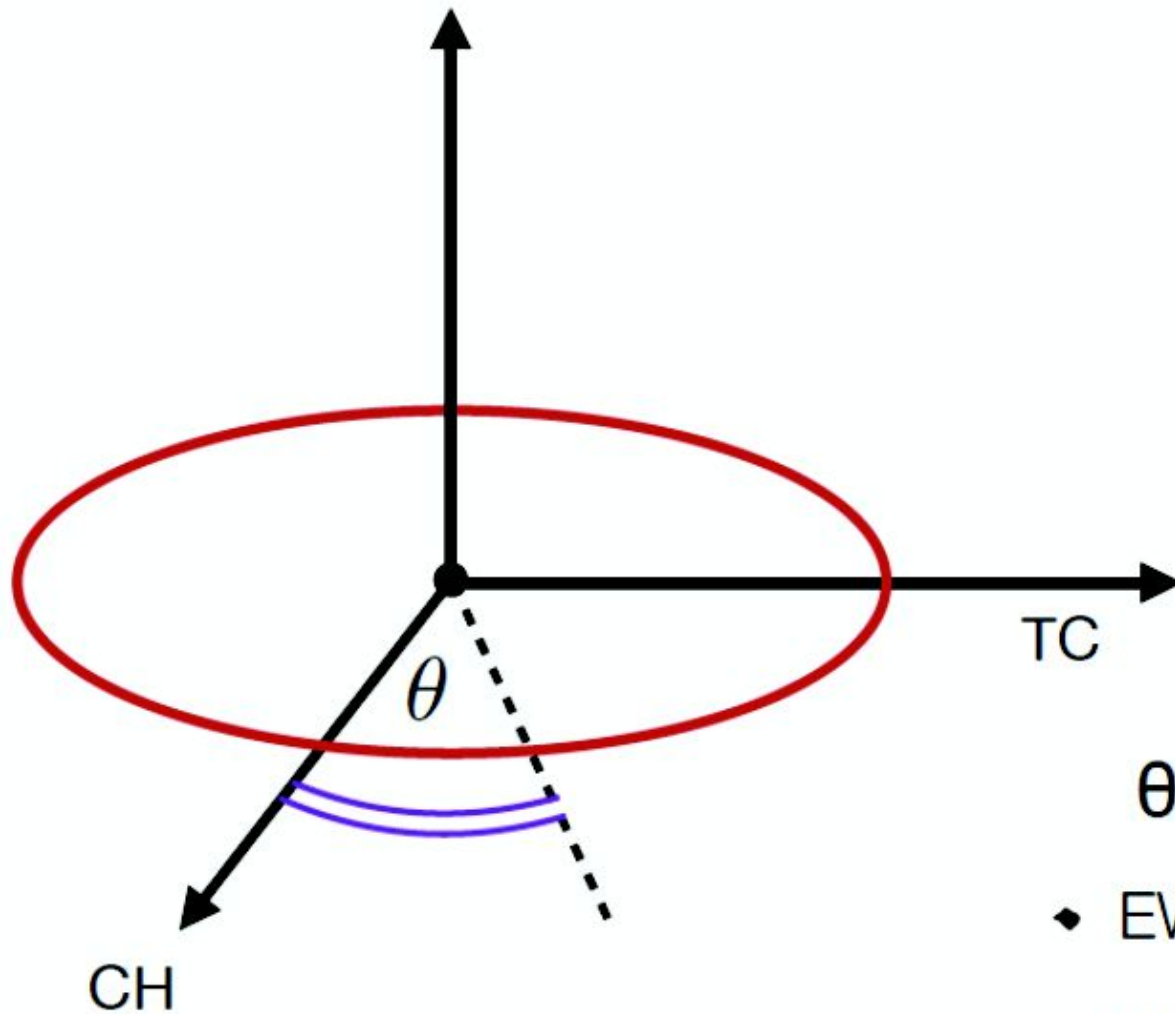

$$\theta = 0$$

- EW does not break
- Higgs is exact GB

$$\theta = \pi/2$$

- EW breaks
- Higgs is massive excitation

Technicolor vs Composite Higgs

(Galloway, Evans, Tacchi & Luty '10
G. Cacciapaglia & F. Sannino '14)

- ◆ Gauge bosons quantum corrections
- ◆ Top corrections
- ◆ Explicit breaking of global symmetry

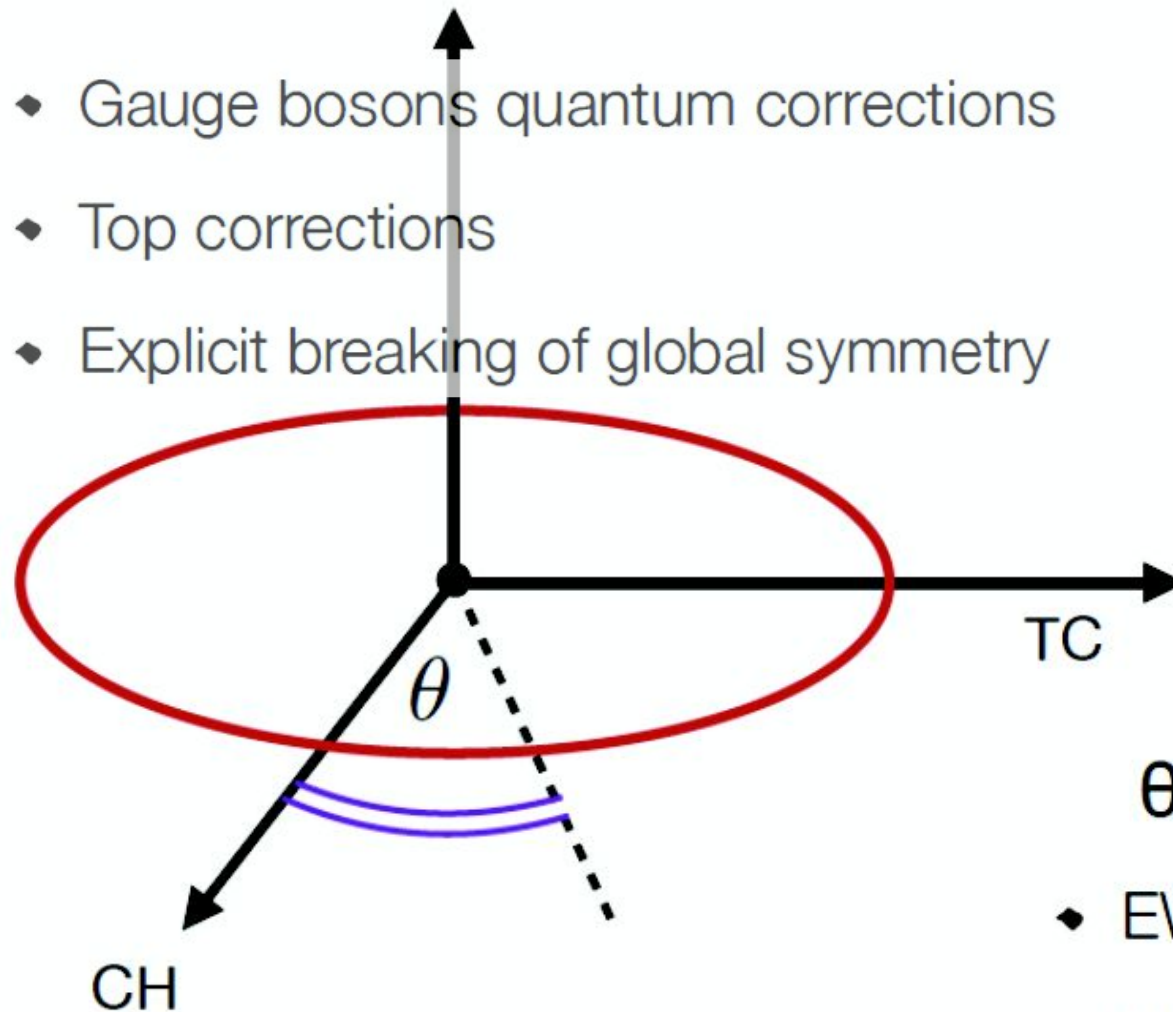

$$\theta = 0$$

- ◆ EW does not break
- ◆ Higgs is exact GB

$$\theta = \pi/2$$

- ◆ EW breaks
- ◆ Higgs is massive excitation

Higgs boson properties are consistent with all promising BSM models encouraging us to keep searching for underlying theory of Nature!

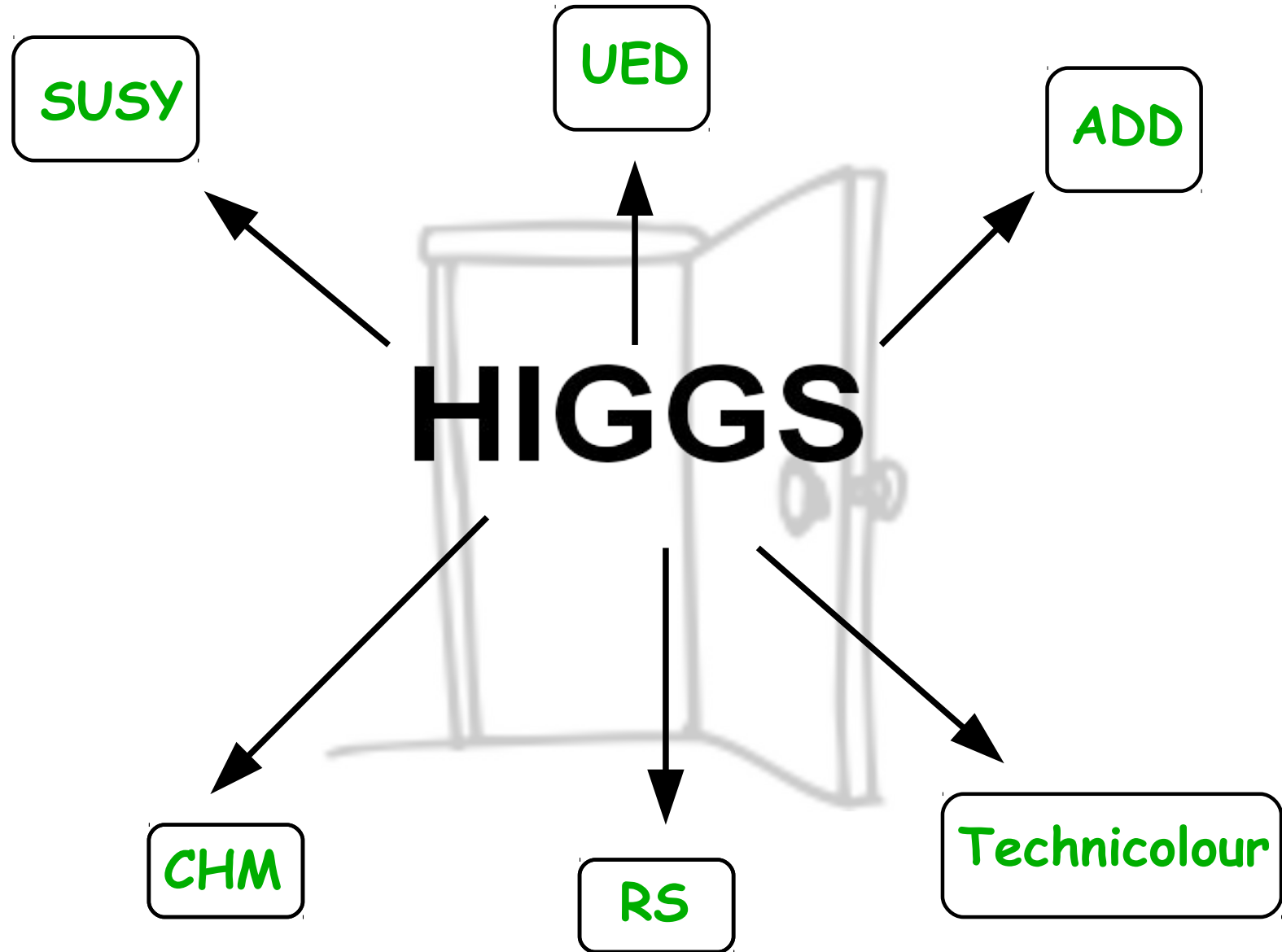

Theories and new particles

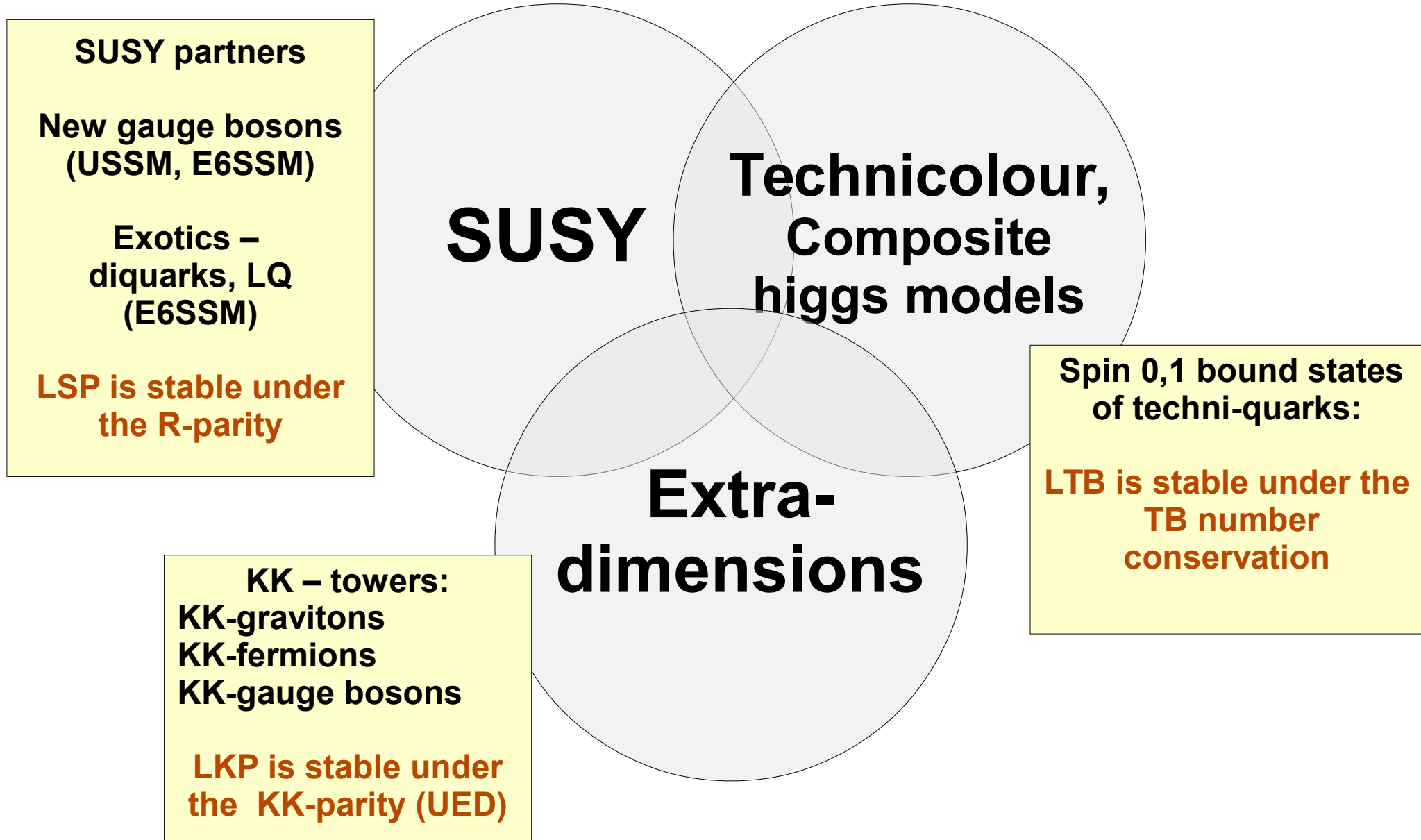

Theories and new signatures

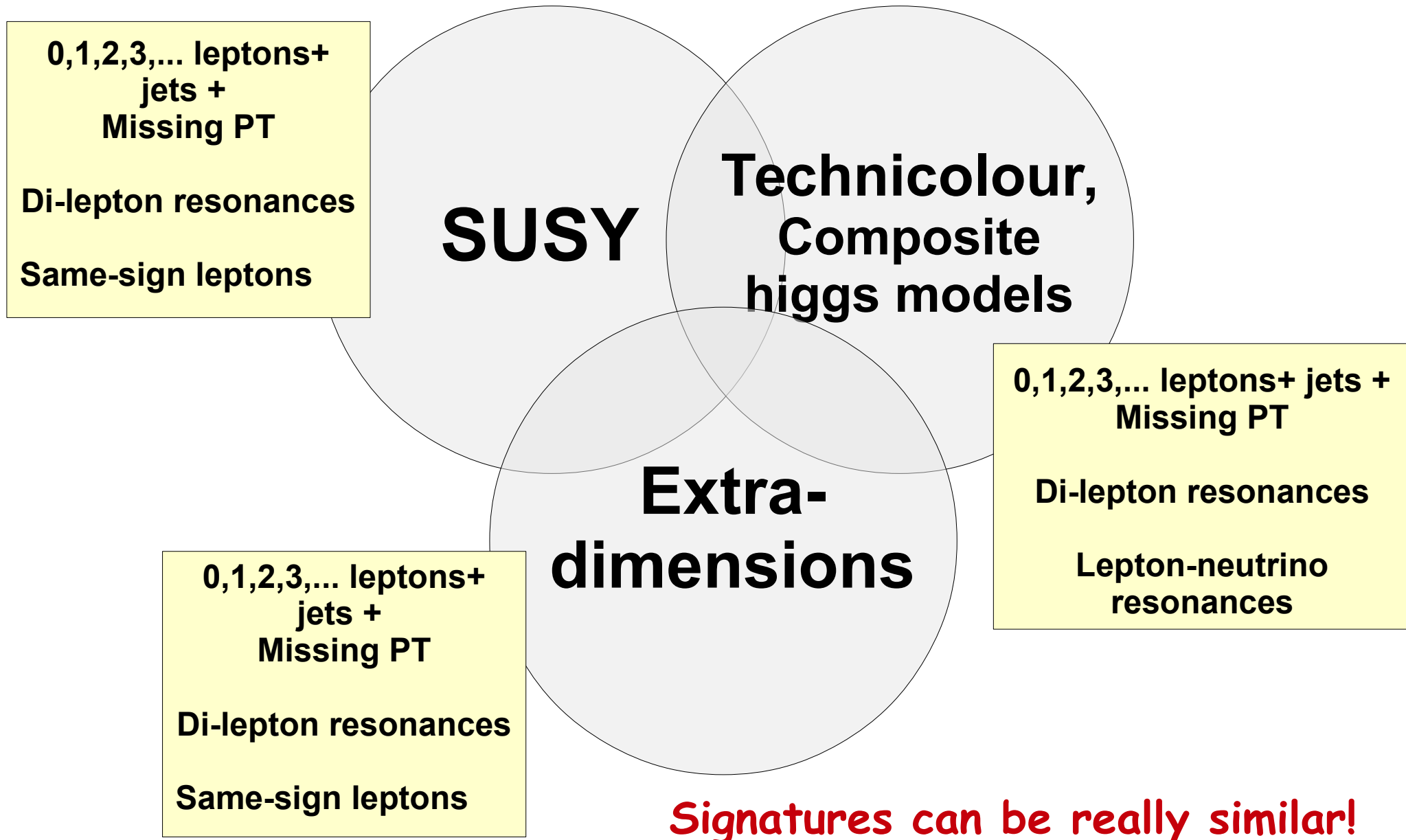

Signatures can be really similar!

The main problem is to decode an underlying theory from the complicated set of signatures: down->top



The main problem is to decode an underlying theory from the complicated set of signatures: down- \rightarrow top

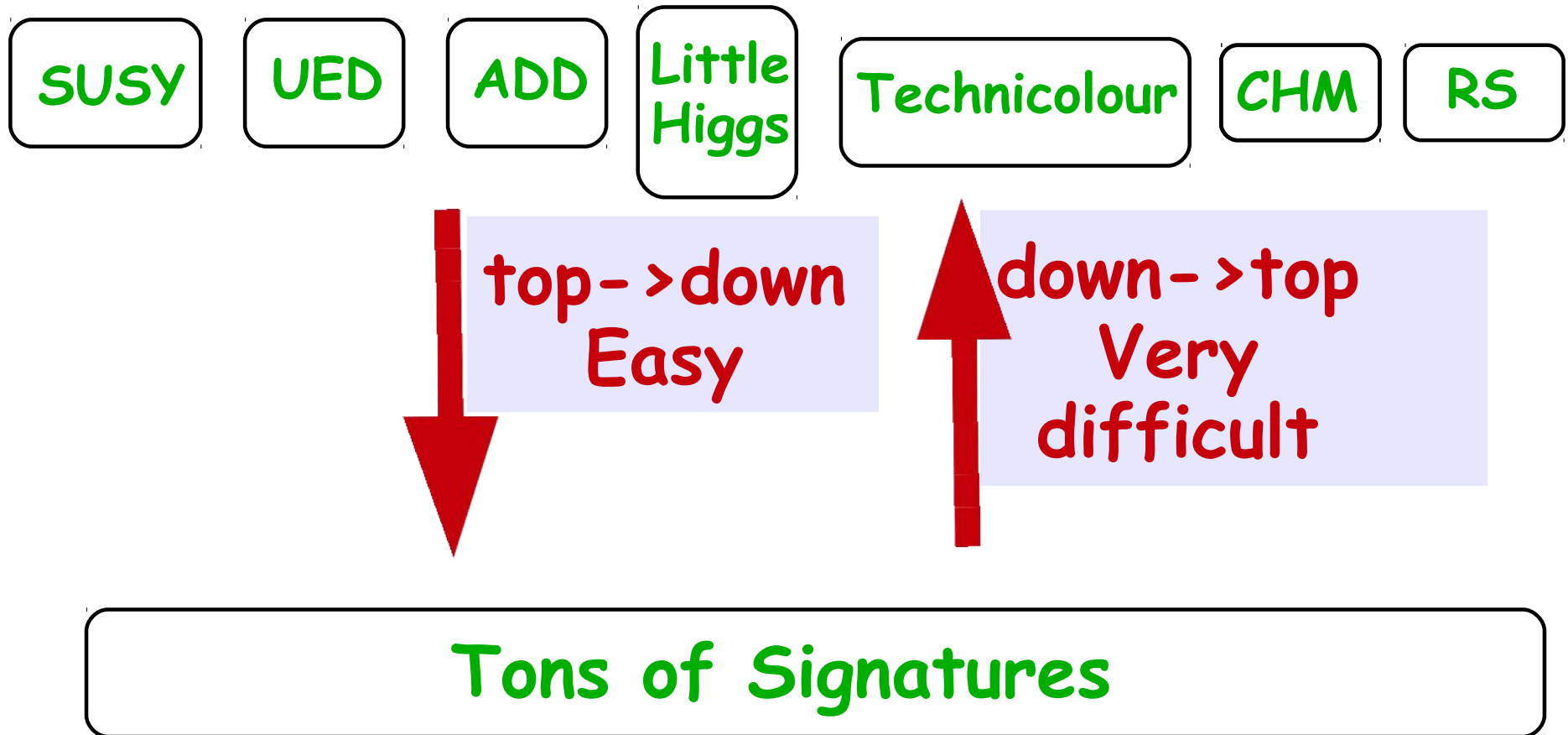

The main problem is to decode an underlying theory from the complicated set of signatures: down->top

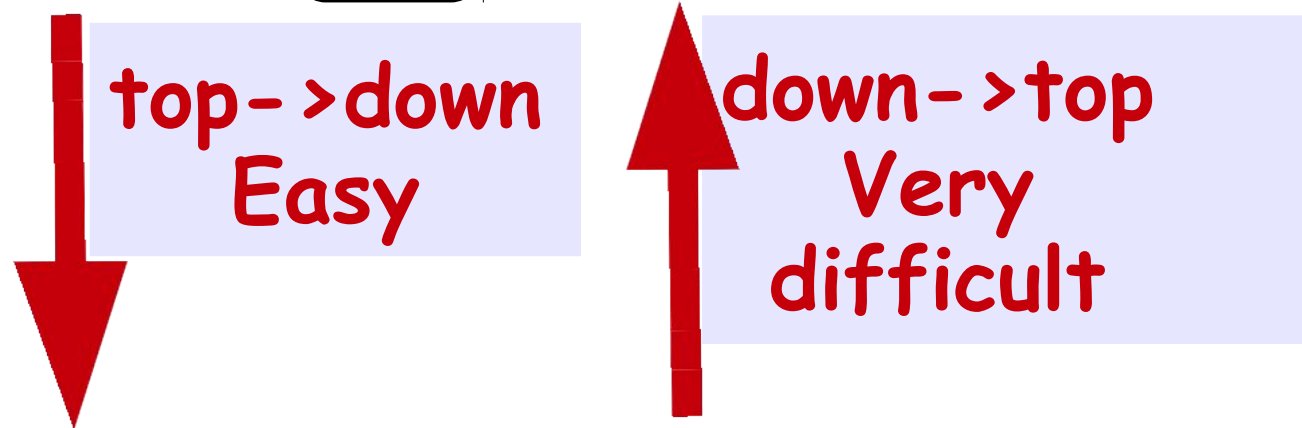

Tons of Signatures

HEPMDB

High Energy Physics Model Data Base

<https://hepmdb.soton.ac.uk/>

THANK YOU!

- Thanks to all organizers for fantastic School/Workshop/time in Dubna, boat trip and weather during the weekend!
- Thanks to all for inspiring talks, questions and discussions!
- Thanks to everybody!

Additional Slides

6D UED (Dark Matter in a twisted bottle)

Arbey, Cacciapaglia, Deandrea, Kubik'12

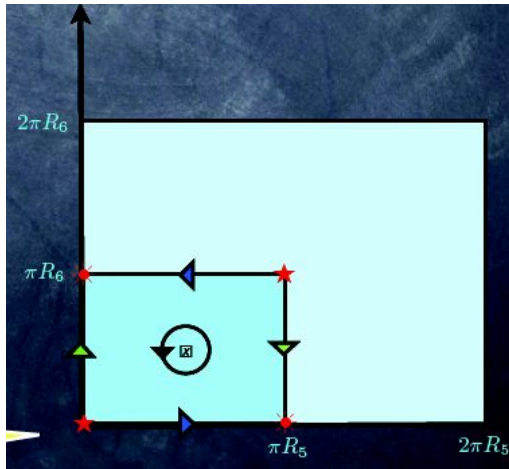

Spectrum of the SM

	+	-	+	+	-
$p_{KK} = (-1)^{k+l}$	(0,0) m = 0	(1,0) & (0,1) m = 1	(1,1) m = 1.41	(2,0) & (0,2) m = 2	(2,1) & (1,2) m = 2.24
Gauge bosons G, A, Z, W	✓		✓	✓	✓
Gauge scalars G, A, Z, W		✓	✓		✓
Higgs boson(s)	✓		✓	✓	✓
Fermions	✓	✓	✓ (x2)	✓	✓ (x2)

DM candidate here!

6D UED DM bounds

Arbey, Cacciapaglia, Deandrea, Kubik'12

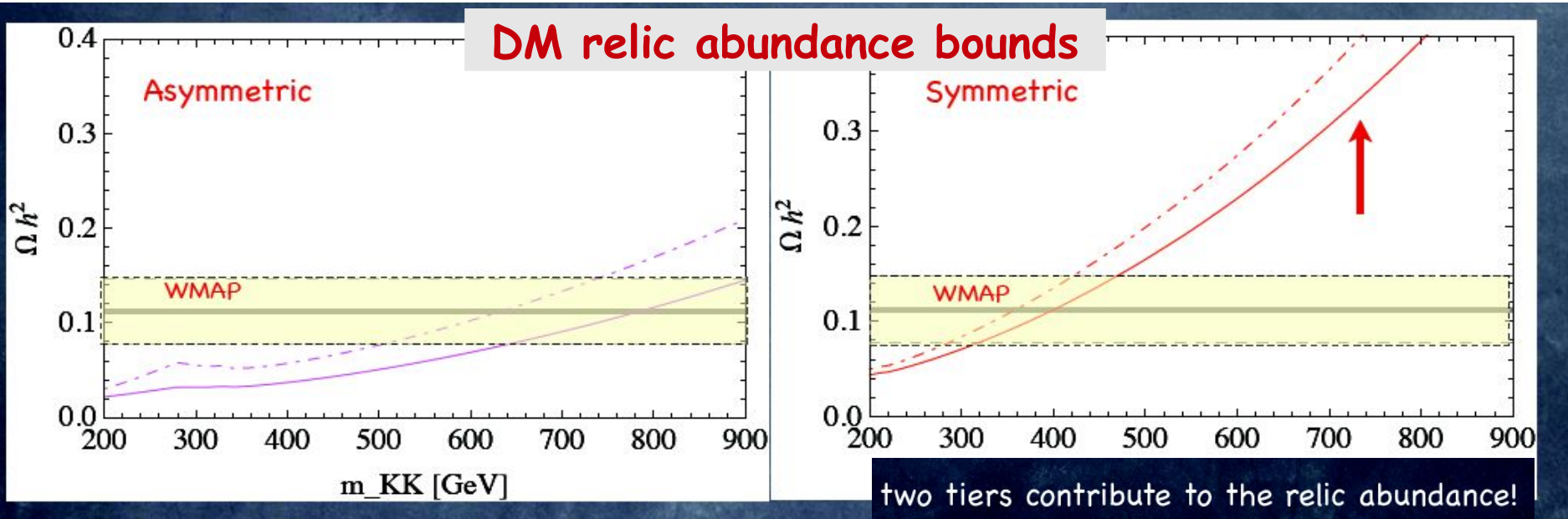

$$R_5 > R_6$$

$$R_5 = R_6$$

DM direct detection bounds

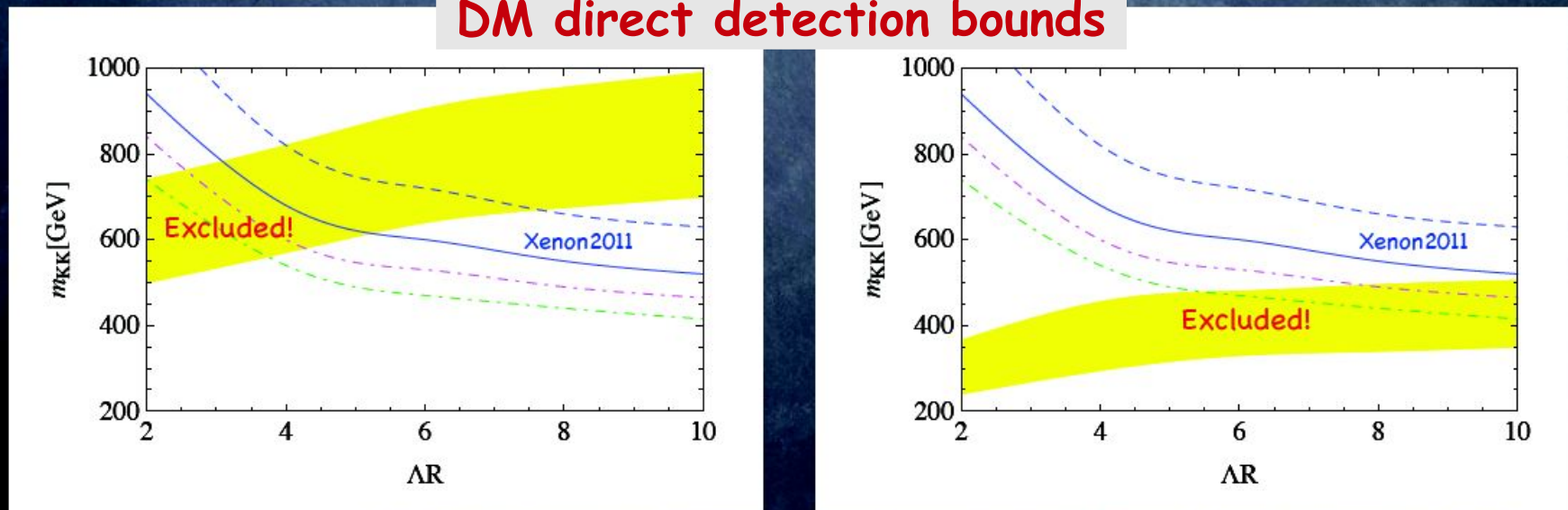

6D UED LHC bounds

Cacciapaglia, Deandrea,
Ellis, Marrouche, Panizzi '13

“composition” of signal signatures

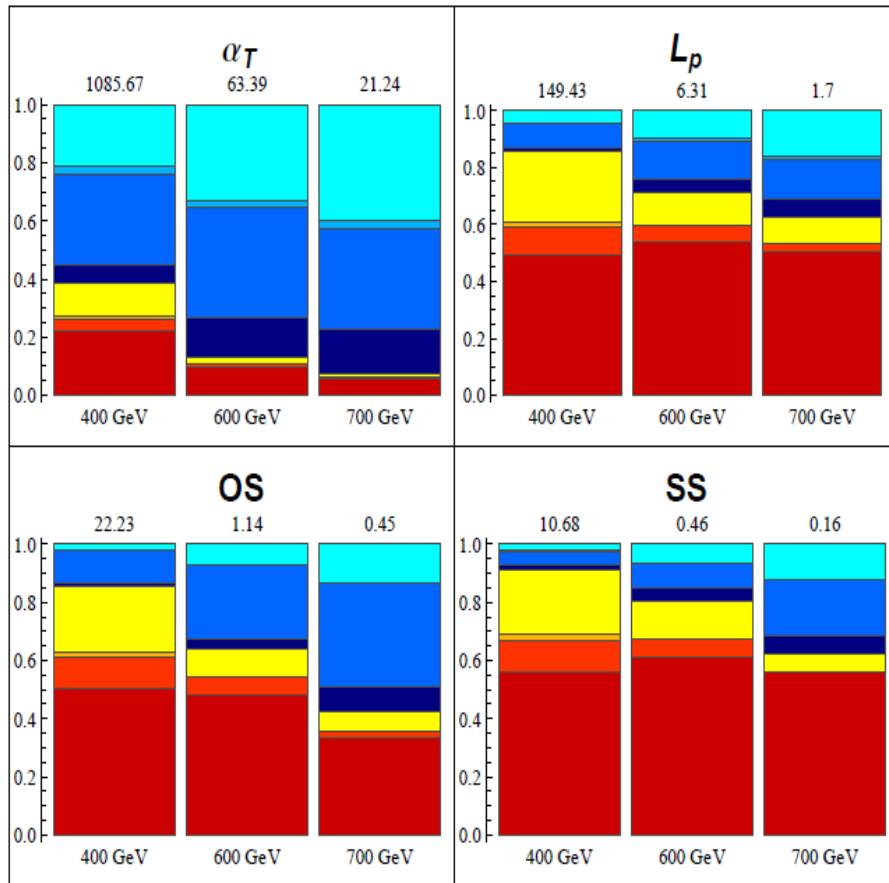

MHT-HT analysis plane

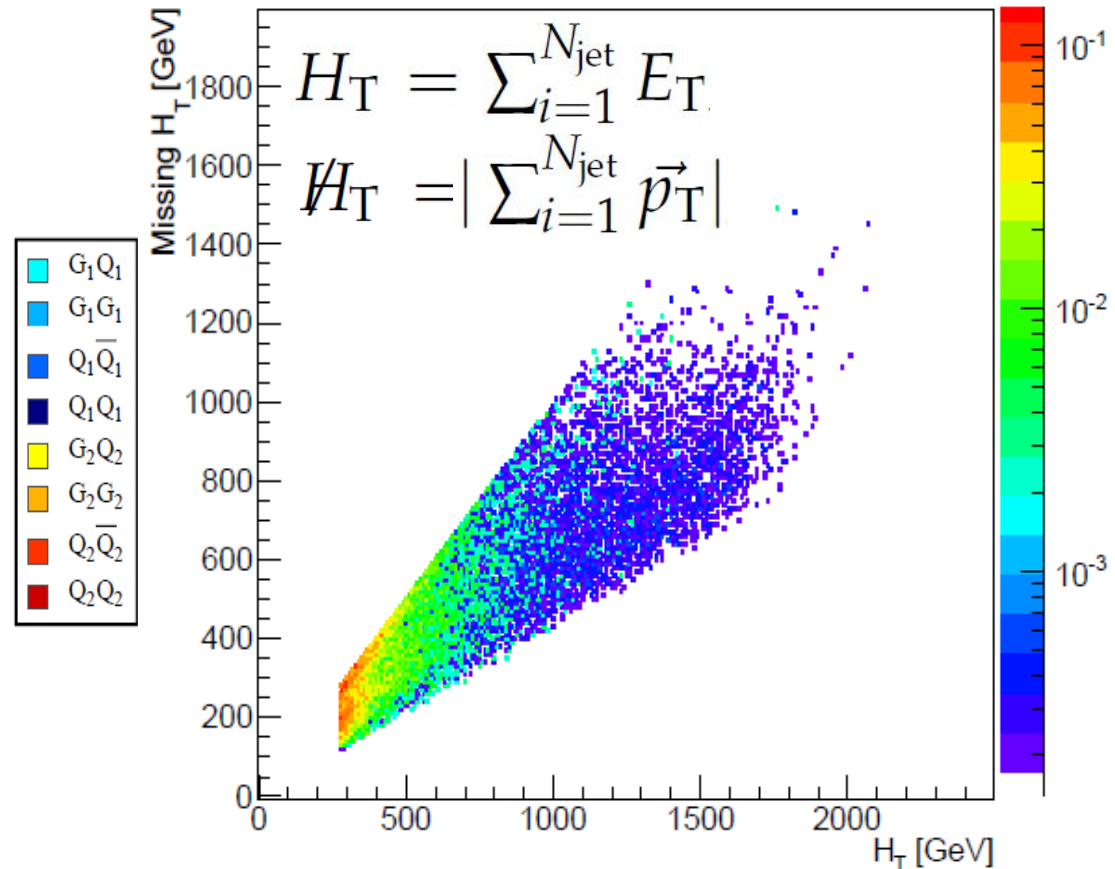

Exclusion limit: $M_{KK} > 600-700 \text{ GeV}$
Almost all parameter space is excluded

$$\alpha_T = \frac{p_T(j_2)}{M_{jj}} = \frac{p_T(j_2)}{\sqrt{H_T^2 - M_{H_T}^2}}$$

The lightest scalar in QCD

QCD σ -photon model Lagrangian, $a_{\sigma\gamma\gamma}$ composite fudge-factor

$$\Gamma_{\sigma \rightarrow \gamma\gamma} = \frac{\alpha^2 (\text{Re } m_\sigma)^3 a_{\sigma\gamma\gamma}^2}{256\pi^3 f_\pi^2} \left| 3 \left(\frac{2}{3}\right)^2 F_{1/2}\left(\frac{4m_u^2}{(\text{Re } m_\sigma)^2}\right) + 3 \left(-\frac{1}{3}\right)^2 F_{1/2}\left(\frac{4m_d^2}{(\text{Re } m_\sigma)^2}\right) \right|^2$$

Compare with QCD data:

(Belyaev, Brown, Foadi, MTF & Sannino '13)

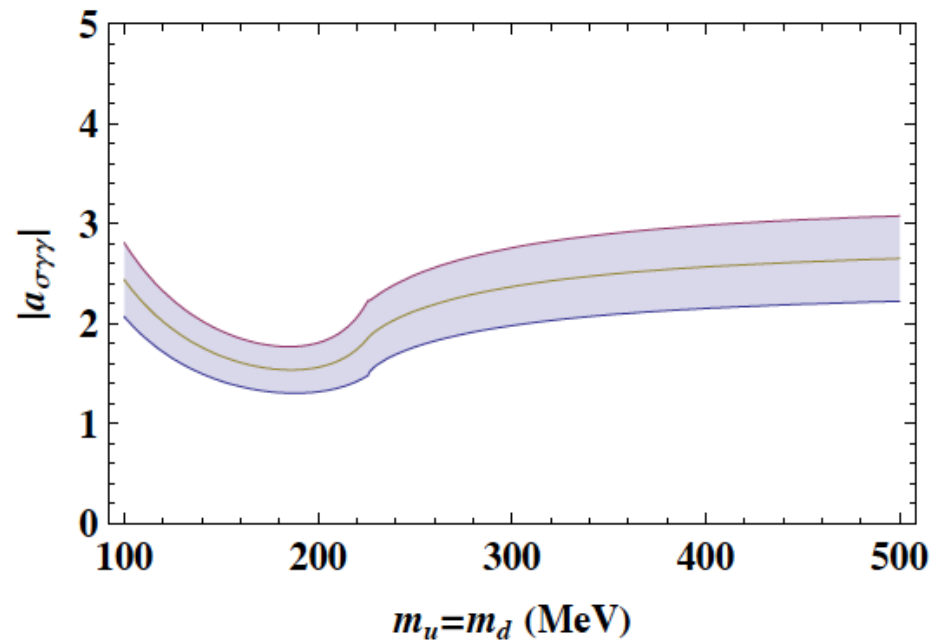

The Techni-Higgs scalar in QCD

Scaled up QCD-like Techni-Higgs would have (diboson) Higgs-like couplings

Coefficient $c_{\pi \sim 1}$ is independent of number of colors or size of representation

Techni-Higgs photon model Lagrangian

$$g_{H\gamma\gamma}^{\text{TC}} = \frac{\alpha}{8\pi} \left| c_{\Pi} [F_1(\tau_W) - 2] + \sum_f c_f N_c^f Q_f^2 F_{1/2}(\tau_f) + a_{H\gamma\gamma} d(R_{\text{TC}}) \sum_F N_c^F Q_F^2 F_{1/2}(\tau_F) \right|$$

The Techni-Higgs scalar in QCD

Example fit to LHC Data

$$g_{H\gamma\gamma}^{\text{TC}} = \frac{\alpha}{8\pi} \left| c_{\Pi} [F_1(\tau_W) - 2] + \sum_f c_f N_c^f Q_f^2 F_{1/2}(\tau_f) + a_{H\gamma\gamma} d(R_{\text{TC}}) \sum_F N_c^F Q_F^2 F_{1/2}(\tau_F) \right|$$

Fit to QCD data

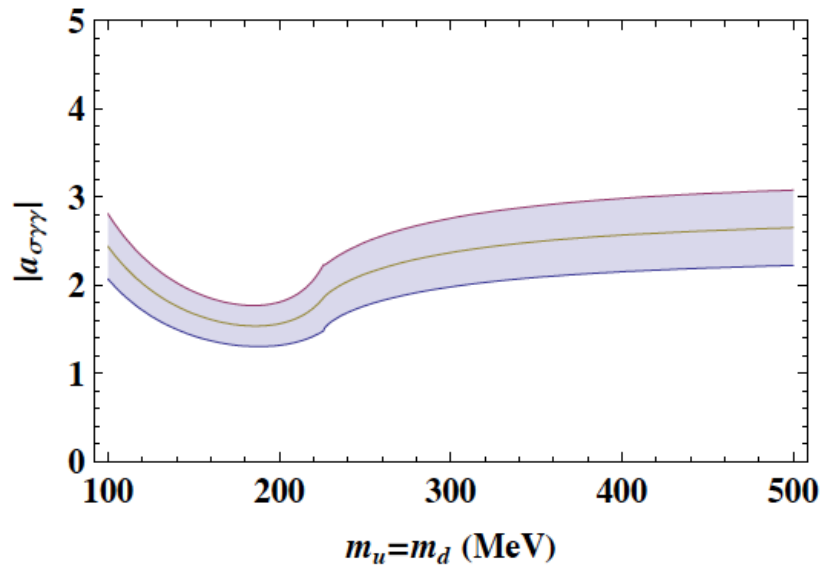

Fit to LHC data

