

Precision β -decay measurements in nuclei

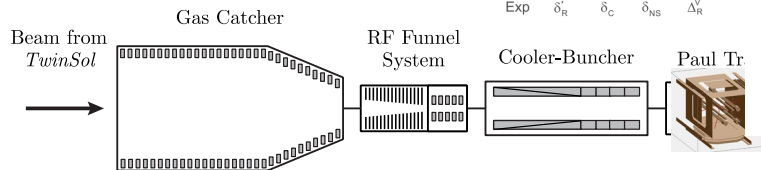
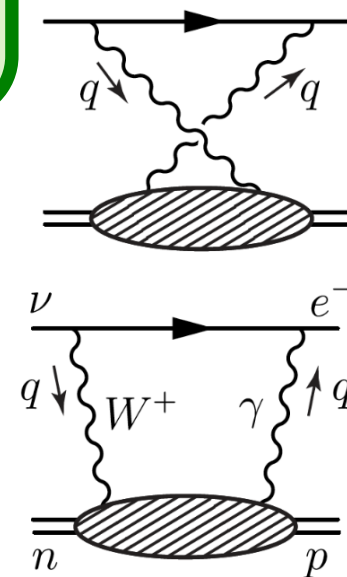
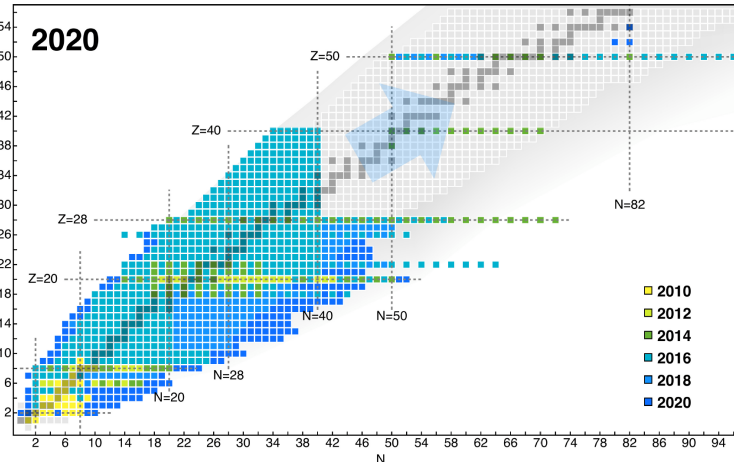
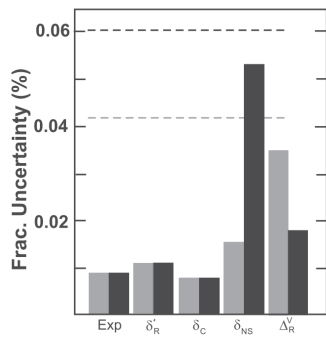
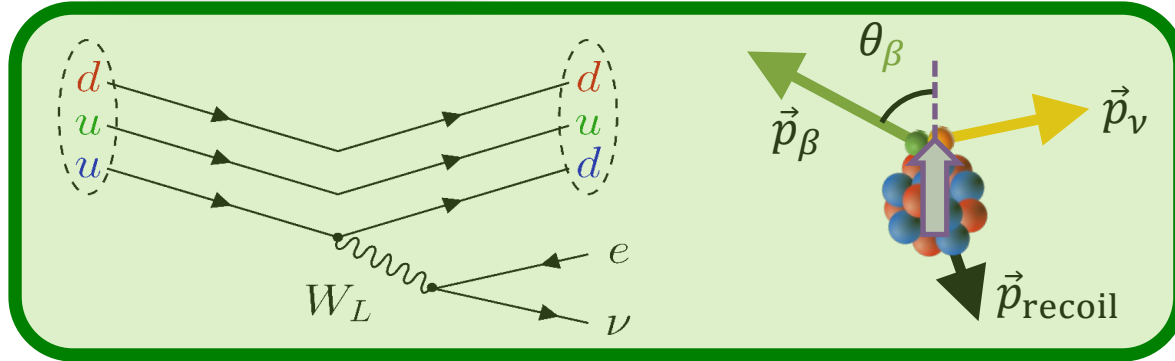
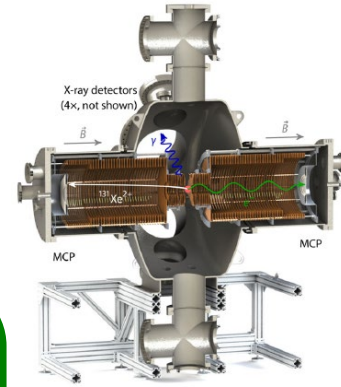
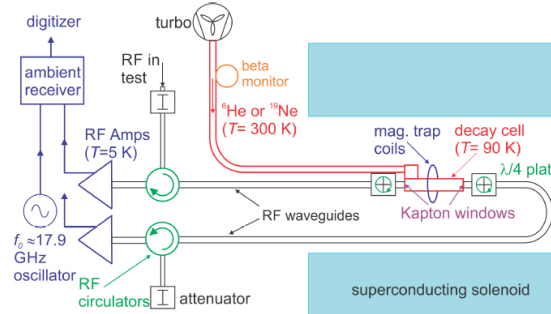
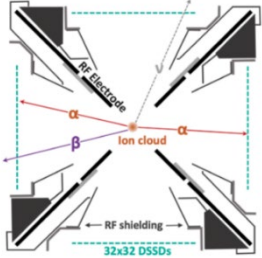

Dan Melconian

Outline

Not at all dissimilar from what was said at the Town Hall Meetings last fall

Resulting White Paper is 7 pages of awesome physics (5 pgs of citations)

arXiv:2301.03975v1 [nucl-ex] 10 Jan 2023

Nuclear β decay as a probe for physics beyond the Standard Model

M. Brodeur,¹ N. Buzinsky,² M.A. Caprio,¹ V. Cirigliano,³ J.A. Clark,⁴ P.J. Fasano,¹ J.A. Formaggio,⁵ A.T. Gallant,⁶ A. Garcia,² S. Gandolfi,⁷ S. Gardner,⁸ A. Glick-Magid,² L. Hayen,^{9,10} H. Hergert,^{11,12} J. D. Holt,^{13,14} M. Horoi,¹⁵ M.Y. Huang,¹⁶ K.D. Launey,¹⁷ K.G. Leach,^{18,19} B. Longfellow,⁶ A. Lovato,²⁰ A.E. McCoy,^{19,21} D. Melconian,^{22,23} P. Mohanmurthy,⁵ D.C. Moore,²⁴ P. Mueller,⁴ E. Mereghetti,²⁵ W. Mittig,^{26,19} P. Navratil,¹³ S. Pastore,^{21,27} M. Piarulli,^{21,27} D. Puentes,^{26,19} B.C. Rasco,²⁸ M. Redshaw,¹⁵ G.H. Sarguyan,⁶ G. Savard,^{4,29} N.D. Scielzo,⁶ C.-Y. Seng,^{2,19} A. Shindler,^{11,12} S.R. Stroberg,¹ J. Surbrook,^{26,19} A. Walker-Loud,³⁰ R. B. Wiringa,³¹ C. Wrede,^{26,19} A. R. Young,^{32,33} and V. Zelevinsky^{26,19}

¹Department of Physics and Astronomy, University of Notre Dame, Notre Dame, IN 46556 USA

²Department of Physics, University of Washington, Seattle, Washington 98195, USA

³Institute for Nuclear Theory, University of Washington, Seattle, WA 98195, USA

⁴Physics Division, Argonne National Laboratory, Lemont, Illinois 60439, USA

⁵Laboratory for Nuclear Science, Massachusetts Institute of Technology, 77 Mass. Ave., Cambridge, MA 02139

⁶Nuclear and Chemical Sciences Division, Lawrence Livermore National Laboratory, Livermore, California 94550, USA

⁷Theoretical Division, Los Alamos National Laboratory

⁸Department of Physics and Astronomy, University of Kentucky, Lexington, KY 40506-0055

⁹Department of Physics, North Carolina State University, Raleigh, North Carolina 27695, USA

¹⁰Triangle Universities Nuclear Laboratory, Durham, North Carolina 27708, USA

¹¹Facility for Rare Isotope Beams, Michigan State University, East Lansing, Michigan 48824, USA

¹²Department of Physics & Astronomy, Michigan State University, East Lansing, Michigan 48824, USA

¹³TRIUMF, Vancouver, BC V6T 2A3, Canada

¹⁴Department of Physics, McGill University, Montréal, QC H3A 2T8, Canada

¹⁵Department of Physics, Central Michigan University, Mount Pleasant, MI 48859, USA

¹⁶Department of Physics and Astronomy, Iowa State University, Ames, IA 50011, USA

¹⁷Department of Physics and Astronomy, Louisiana State University, Baton Rouge, LA 70803, USA

¹⁸Department of Physics, Colorado School of Mines, Golden, CO 80401, USA

¹⁹Facility for Rare Isotope Beams, Michigan State University, East Lansing, MI 48824, USA

²⁰Physics Division, Argonne National Laboratory, Lemont, IL 60439, USA

²¹Department of Physics, Washington University in Saint Louis, Saint Louis, MO 63130, USA

²²Cyclotron Institute, Texas A&M University, 3366 TAMU, College Station, Texas 77843-3366, USA

²³Department of Physics and Astronomy, Texas A&M University,

4242 TAMU, College Station, Texas 77843-4242, USA

²⁴Wright Laboratory, Department of Physics, Yale University, New Haven, CT 06520, USA

²⁵Los Alamos National Laboratory, Los Alamos, NM 87545, USA

²⁶Department of Physics and Astronomy, Michigan State University, East Lansing 48824, USA

²⁷McDonnell Center for the Space Sciences at Washington University in St. Louis, MO 63130, USA

²⁸Physics Division, Oak Ridge National Laboratory, Oak Ridge, TN 37830, USA

²⁹Department of Physics, University of Chicago, Chicago, Illinois 60637, USA

³⁰Nuclear Science Division, Lawrence Berkeley National Laboratory, Berkeley, CA, 94720, USA

³¹Physics Division, Argonne National Laboratory, Lemont, IL 60439, USA

³²Department of Physics, North Carolina State University, Raleigh 27695, USA

³³Triangle Universities Nuclear Laboratory, Duke University, Durham 27708, USA

(Dated: January 11, 2023)

This white paper was submitted to the 2022 Fundamental Symmetries, Neutrons, and Neutrinos (FSNN) Town Hall Meeting in preparation for the next NSAC Long Range Plan. We advocate to support current and future theoretical and experimental searches for physics beyond the Standard Model using nuclear β decay.

Outline

- CKM matrix unitarity tests
 - ✳ Theory has made huge progress
 - ✳ New experiments targeting low-Z cases, mirror transitions
- Searches for scalar and tensor currents
 - ✳ Spectrum-shape for Fierz
 - ✳ Ion and atom traps
- β decays for neutrino physics
 - ✳ Ultra-low Q-values for direct m_ν measurements
 - ✳ Sterile neutrinos via EC
 - ✳ Reactor antineutrino anomaly

In case I run out of time (which I will...)



Start with the White Paper recommendations:

- ✱ Experimental + theoretical alliance for V_{ud} and CKM unitarity
- ✱ Investing in small- and mid-scale projects
- ✱ Establishing support for nuclear theory
- ✱ Developing cutting-edge techniques
- ✱ Promote diverse and inclusive environment, and better support for students



Thanks for input (apologies to all)

- ✱ Maxime Brodeur, Drew Byron, Jason Clark, Leendert Hayen, Kyle Leach, Charlie Rasco, Matt Redshaw, Nick Scielzo, Chien Yeah Seng, Louis Varrian, and everyone on the nuclear β decay White Paper

β -decay correlations and ft values

Quick reminder:

$$dW = dW_0 \left[1 + a \frac{\vec{p}_\beta \cdot \vec{p}_\nu}{E_\beta E_\nu} + b \frac{\Gamma m_e}{E_\beta} + \frac{\langle \vec{I} \rangle}{I} \cdot \left(A_\beta \frac{\vec{p}_\beta}{E_\beta} + B_\nu \frac{\vec{p}_\nu}{E_\nu} + D \frac{\vec{p}_\beta \times \vec{p}_\nu}{E_\beta E_\nu} \right) + \dots \right]$$

scalar

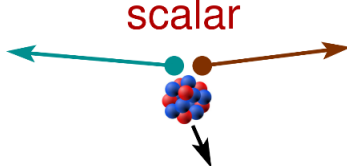

$$a_{\beta\nu} = \frac{-|C_S|^2 - |C'_S|^2}{|C_S|^2 + |C'_S|^2}$$

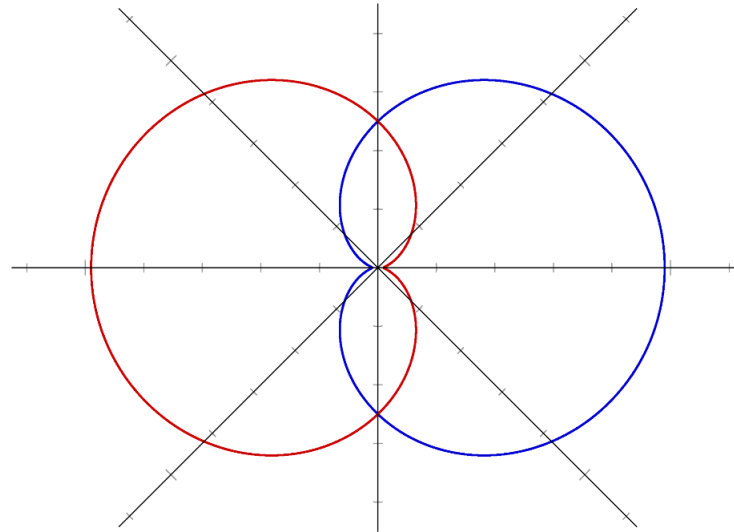

vector

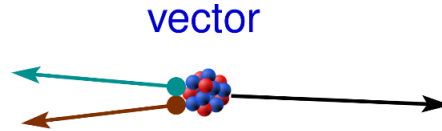

$$a_{\beta\nu} = \frac{|C_V|^2 + |C'_V|^2}{|C_V|^2 + |C'_V|^2}$$

$$a_{\beta\nu} = \frac{|C_V|^2 + |C'_V|^2 - |C_S|^2 - |C'_S|^2}{|C_V|^2 + |C'_V|^2 + |C_S|^2 + |C'_S|^2} = 1??$$

$$b = \frac{-2\Re(C_S^* C_V + C'_S{}^* C'_V)}{|C_V|^2 + |C'_V|^2 + |C_S|^2 + |C'_S|^2} = 0??$$

β -decay correlations and ft values

• Quick reminder:

$$dW = dW_0 \left[1 + a \frac{\vec{p}_\beta \cdot \vec{p}_\nu}{E_\beta E_\nu} + b \frac{\Gamma m_e}{E_\beta} + \frac{\langle \vec{I} \rangle}{I} \cdot \left(A_\beta \frac{\vec{p}_\beta}{E_\beta} + B_\nu \frac{\vec{p}_\nu}{E_\nu} + D \frac{\vec{p}_\beta \times \vec{p}_\nu}{E_\beta E_\nu} \right) + \dots \right]$$

• Comparative half-life:

$$f = \int F(Z', E) C(E) p E (E - E_0)^2 dE \sim Q^5$$

and

$$t = \frac{t_{1/2}}{\text{Br}} (1 + P_{\text{EC}})$$

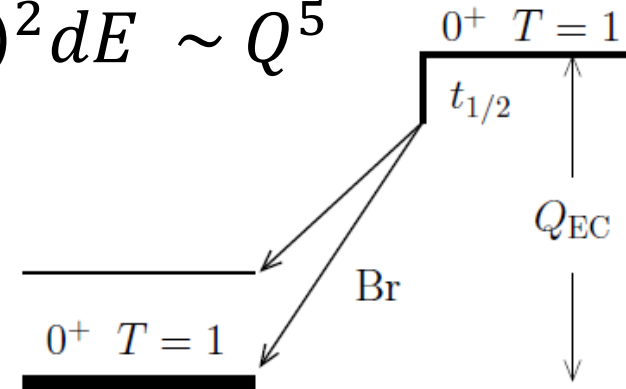

$$\begin{aligned} Ft &\equiv ft(1 + \delta'_R)(1 + \delta_{NS} - \delta_C) \\ &= \frac{K/G_F^2}{|\mathbf{V}_{ud}|^2 M_F^2 (1 + \Delta_R^V)} \end{aligned}$$

CKM Unitarity

- There are currently indications of non-unitarity at a few σ level

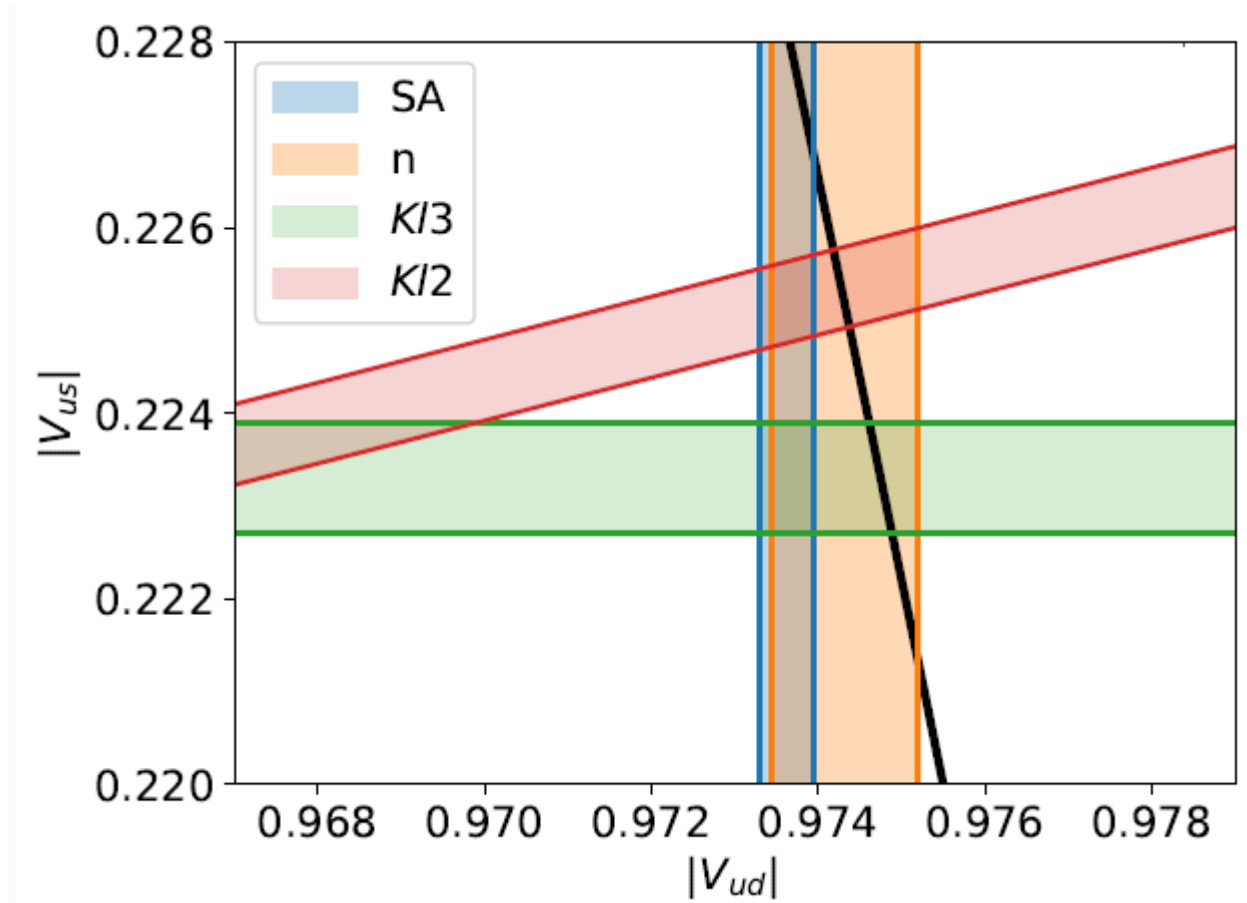

$$V_{ud}^2 + V_{us}^2 + V_{ub}^2 = 0.9982(6)$$

Recent development: theory

Hint of new physics due largely to new calcs of Δ_R^V

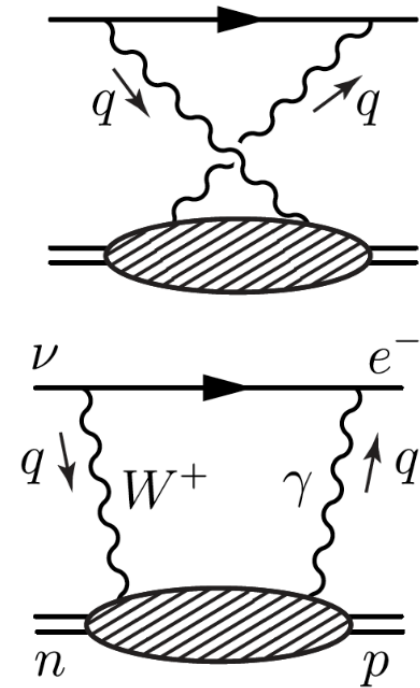
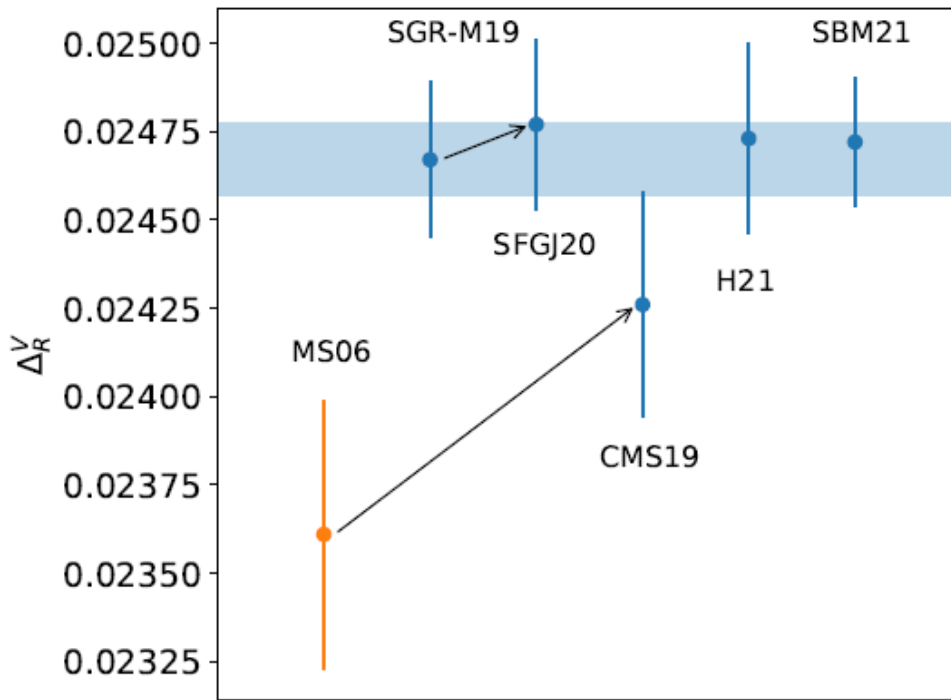

Smaller uncertainty *and* a shift

Recent development: theory

- Hint of new physics due largely to new calcs of Δ_R^V
- New effects to δ_{NS} from quasi-elastic contributions and nuclear polarization effects (1812.03352, 1812.04229):
 $\delta_{NS}(E)$
- Now the (by far) dominant theoretical uncertainty
- Rigorous theory framework based on dispersion relation to compute the NS effects (2211.10214)
- New collaborations are formed to compute δ_{NS} with ab-initio methods for light nuclei

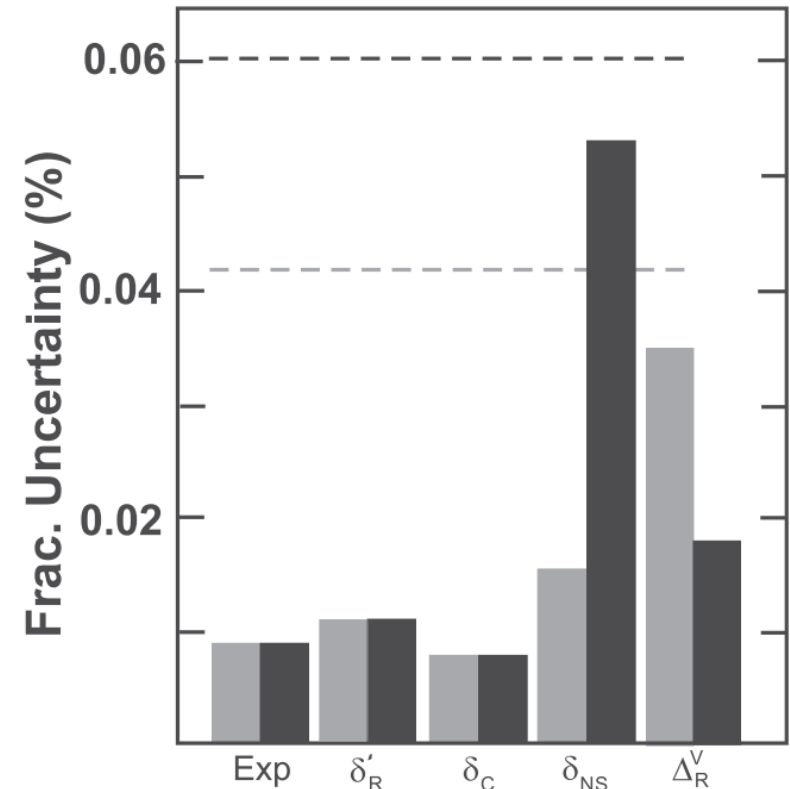

Recent development: theory

- Hint of new physics due largely to new calcs of Δ_R^V
- New effects to δ_{NS} from quasi-elastic contributions and nuclear polarization effects (1812.03352, 1812.04229): $\delta_{NS}(E)$
- Now the (by far) dominant uncertainty: SM theory input
- New connections are found between experimental measurements of charge radii and the isospin breaking correction, δ_C (2208.03037, 2304.03800)

F16.00008
(Sun 9:54am)

Electroweak nuclear radii constrain the isospin breaking correction to V_{ud}

Towards *ab-initio* nuclear theory calculations of δ_C

Chien-Yeah Seng^{1,2,3} and Mikhail Gorchtein^{4,5}

¹Helmholtz-Institut für Strahlen- und Kernphysik and Bethe Center for Theoretical Physics, Universität Bonn, 53115 Bonn, Germany

²Facility for Rare Isotope Beams, Michigan State University, East Lansing, MI 48824, USA

³Department of Physics, University of Washington, Seattle, WA 98195-1560, USA

⁴Institut für Kernphysik, Johannes Gutenberg-Universität, J.J. Becher-Weg 45, 55128 Mainz, Germany and

⁵PRISMA Cluster of Excellence, Johannes Gutenberg-Universität, Mainz, Germany
(Dated: January 13, 2023)

We lay out a novel formalism to connect the isospin-symmetry breaking correction to the rates of superallowed nuclear beta decays, δ_C , to the isospin-breaking sensitive combinations of electroweak nuclear radii that can be accessed experimentally. We individuate transitions in the superallowed decay chart where a measurement of the neutron skin of a stable daughter even at a moderate precision could already help discriminating between models used to compute δ_C . We review the existing experimental situation and make connection to the existing and future experimental programs.

Chien-Yeah Seng^{1,2} and Mikhail Gorchtein^{3,4}

¹Facility for Rare Isotope Beams, Michigan State University, East Lansing, MI 48824, USA

²Department of Physics, University of Washington, Seattle, WA 98195-1560, USA

³Institut für Kernphysik, Johannes Gutenberg-Universität,

J.J. Becher-Weg 45, 55128 Mainz, Germany and

⁴PRISMA Cluster of Excellence, Johannes Gutenberg-Universität, Mainz, Germany

(Dated: April 11, 2023)

We propose a new theory framework to study the isospin-symmetry breaking correction δ_C in superallowed nuclear beta decays, crucial for the precise determination of $|V_{ud}|$. Based on a general assumption of the isovector dominance in ISB interactions, we construct a set of functions F_{T_2} which involve nuclear matrix elements of isovector monopole operators and the nuclear Green's function. Via the functions F_{T_2} , a connection of δ_C to measurable electroweak nuclear radii is established, providing an experimental gauge of the theory accuracy of δ_C . We outline a strategy to perform *ab-initio* calculations of F_{T_2} based on the Lanczos algorithm, and discuss its similarity with other nuclear-structure-dependent inputs in nuclear beta decays.

Ab initio nuclear theory

🌟 *Amazing* progress in just 10 years!!

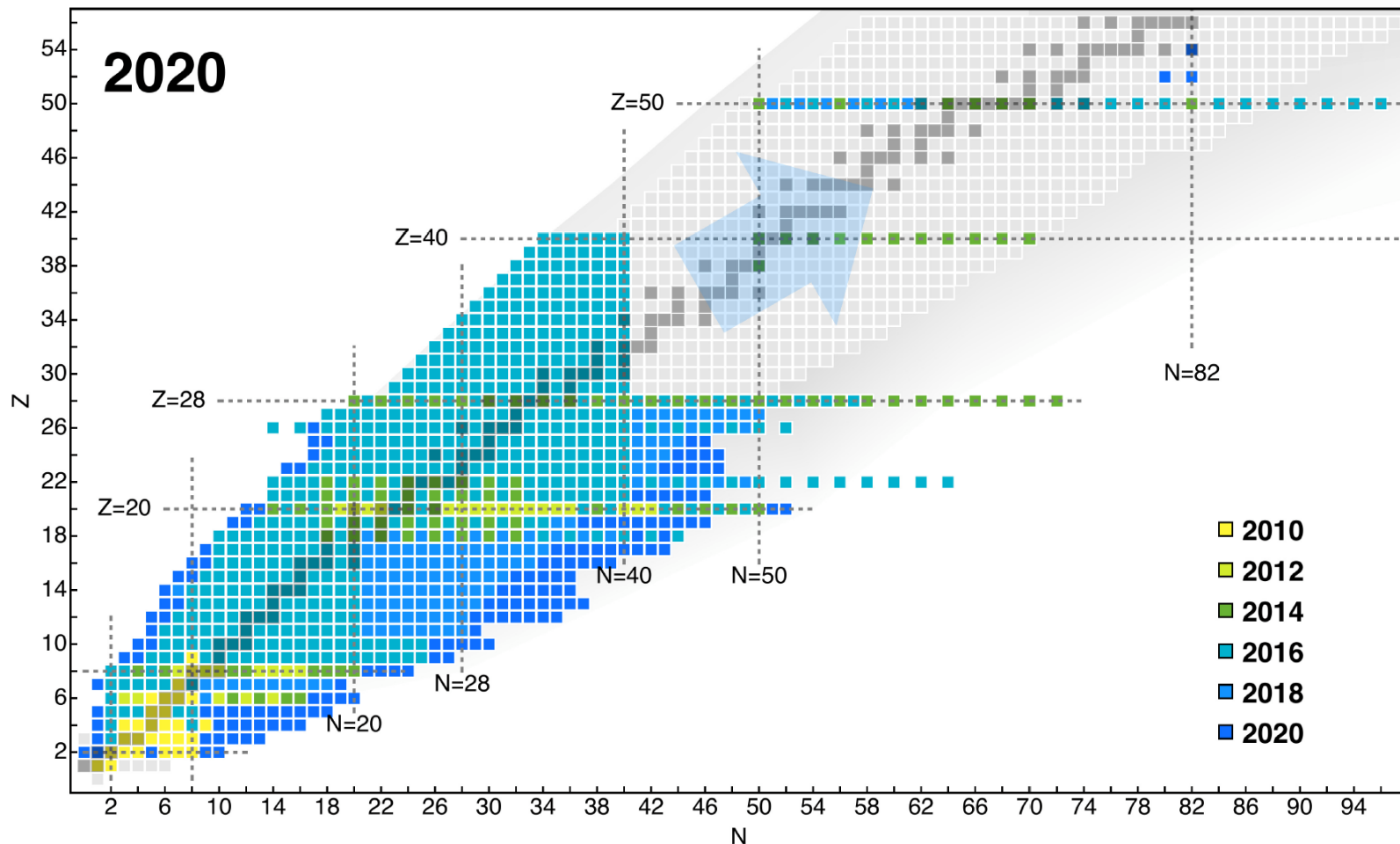

H. Hergert, *Frontiers in Physics* (2020)

Experimental efforts

- Being low-Z, ^{10}C and ^{14}O are the most interesting regarding scalar currents

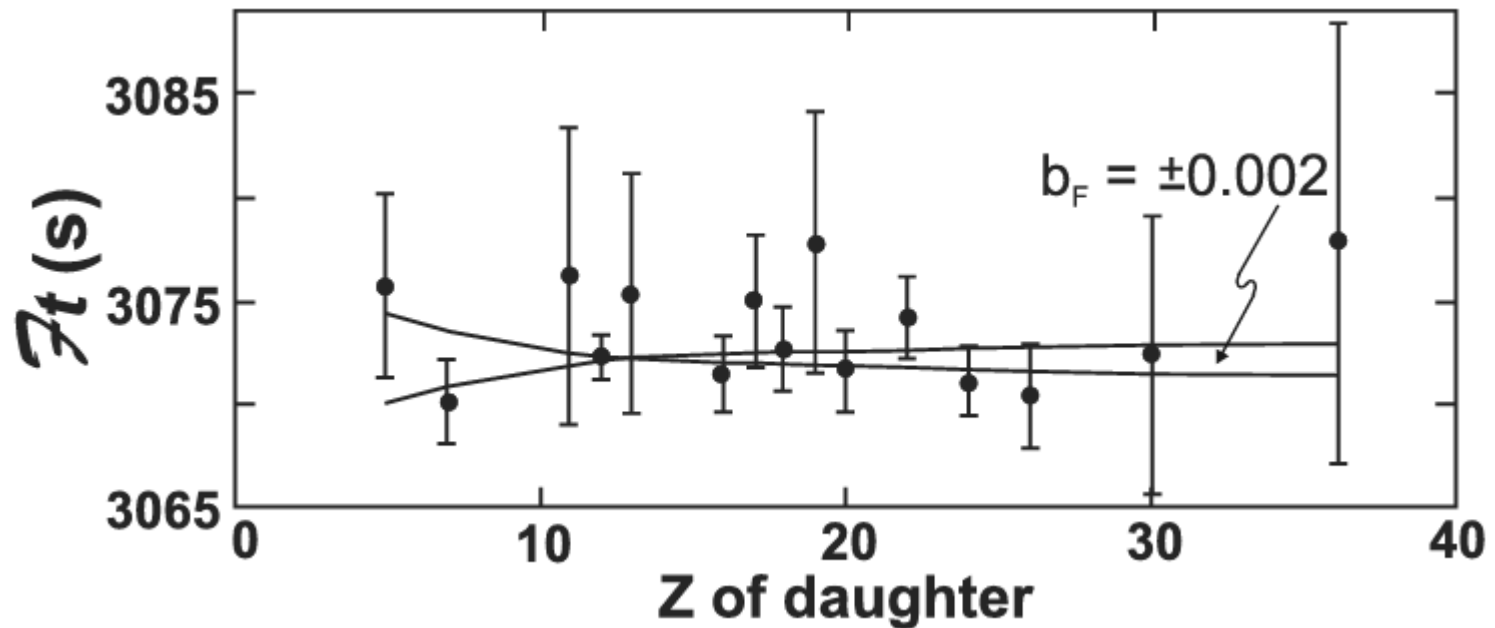

Hardy and Towner's last survey
PRC **102**, 045501 (2020)

Experimental efforts

Being low-Z, ^{10}C and ^{14}O are the most interesting regarding scalar currents

SALER: Superconducting Array for Low-Energy Radiation

Direct implantation and measurement of eV-scale radiation from short-lived ($T_{1/2} > 1$ ms) rare isotopes for BSM physics searches (CKM unitarity, exotic weak currents, etc.)

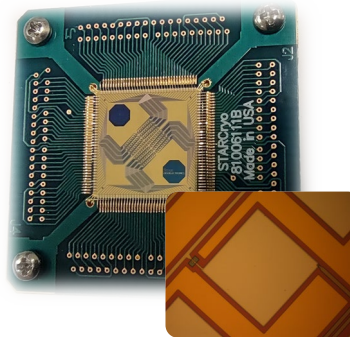

eV-scale nuclear recoil spectroscopy for BSM physics studies

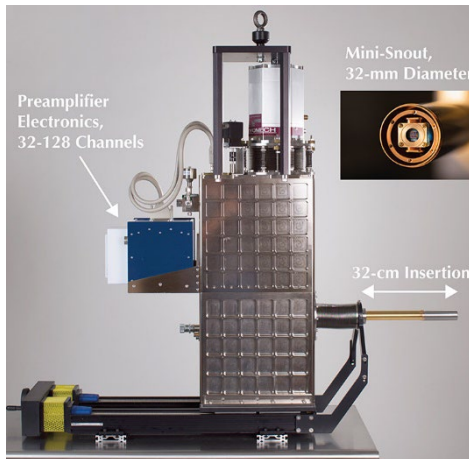

Al degrading foil

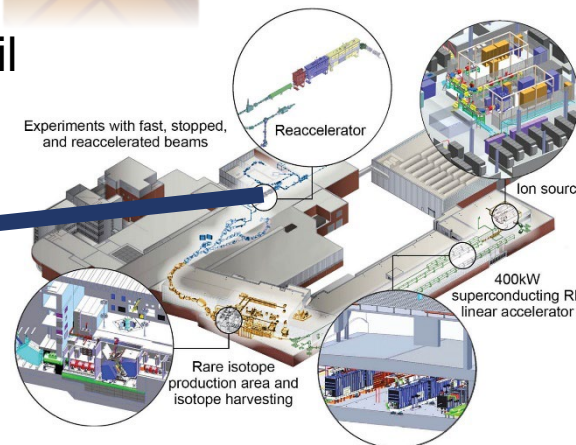
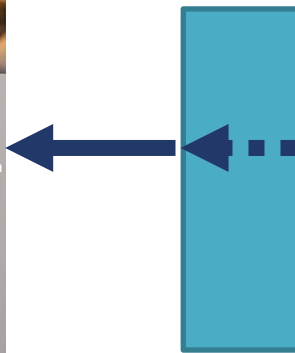

G15.00003
(Sun 11:33 am)

Experimental efforts

Being low- Z , ^{10}C and ^{14}O are the most interesting regarding scalar currents

PRC 101, 055501 (2020)

Proton-rich cases to be studied with WISArD and TAMUTRAP via the kinematic shift of β -delayed proton decays

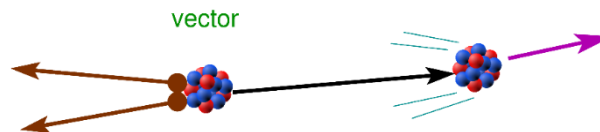
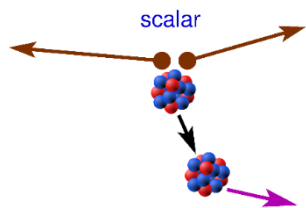
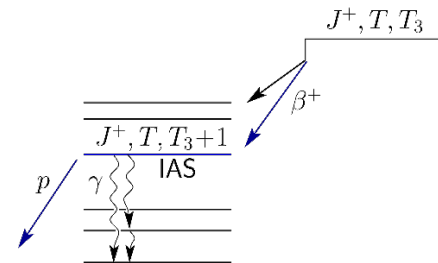
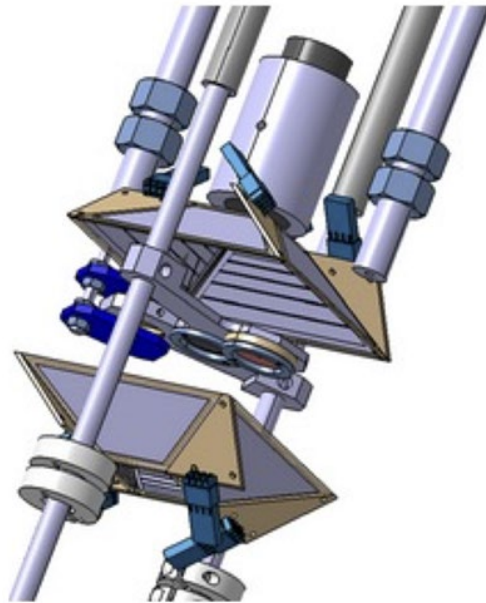

Experimental efforts

Being low- Z , ^{10}C and ^{14}O are the most interesting regarding scalar currents

PRC 101, 055501 (2020)

Proton-rich cases to be studied with WISArD and TAMUTRAP via the kinematic shift of β -delayed proton decays

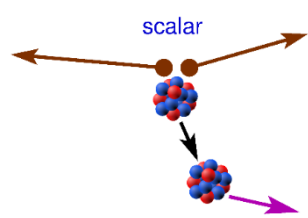
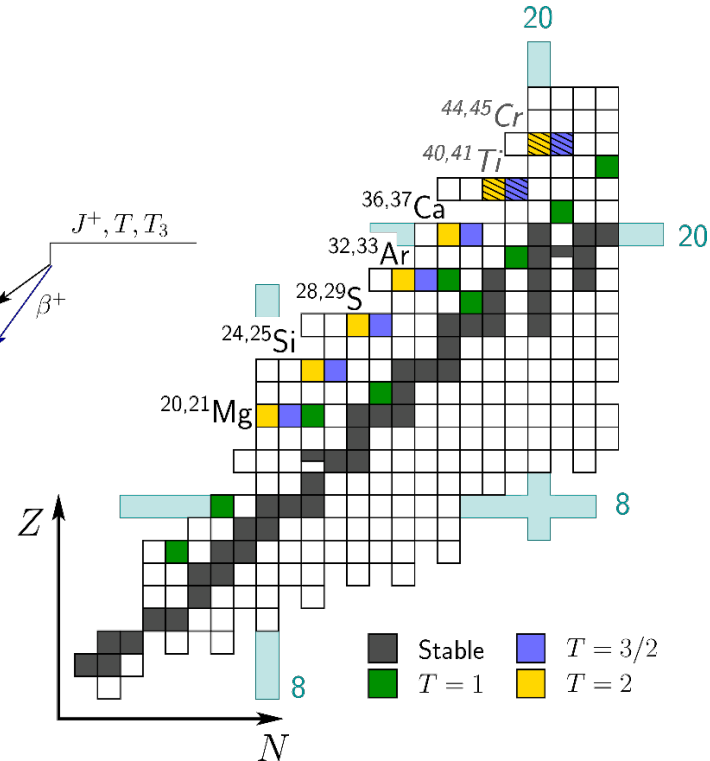
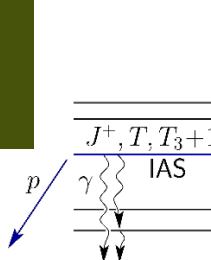
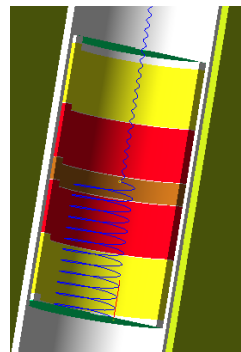
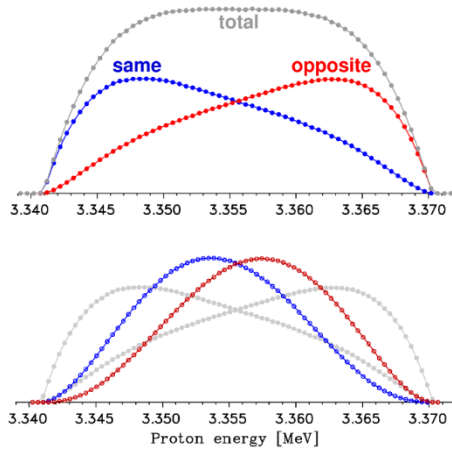
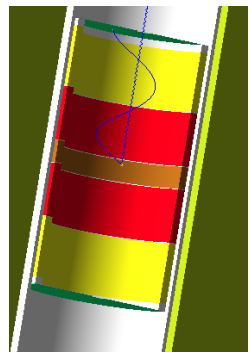

Experimental efforts

- Being low- Z , ^{10}C and ^{14}O are the most interesting regarding scalar currents)
- Proton-rich cases to be studied with TAMUTRAP via the kinematic shift of β -delayed proton decays
- Mirror nuclei continue to be improved as an alternate to $0^+ \rightarrow 0^+$ (and of course the neutron, next talk)
- Lifetimes, β - ν correlations with St. Benedict @ Notre Dame

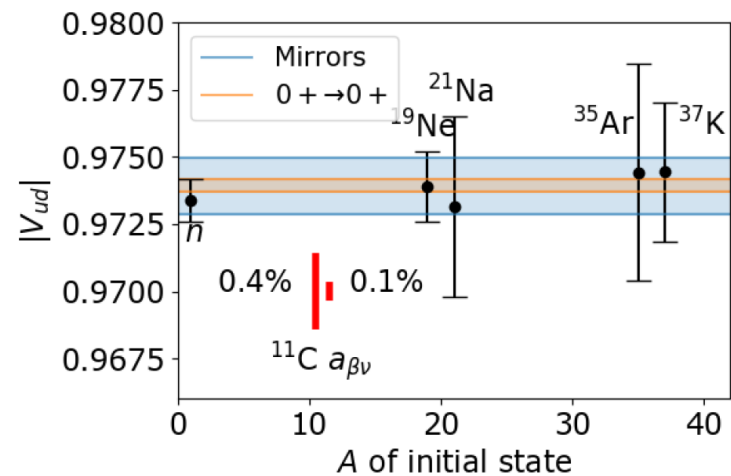
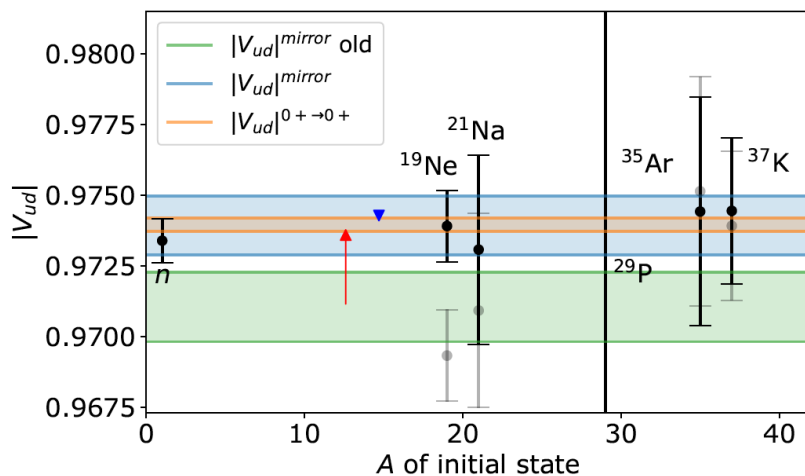

Superaligned Transistor Beta-Neutrino Decay Ion Coincidence Trap (St. Benedict)

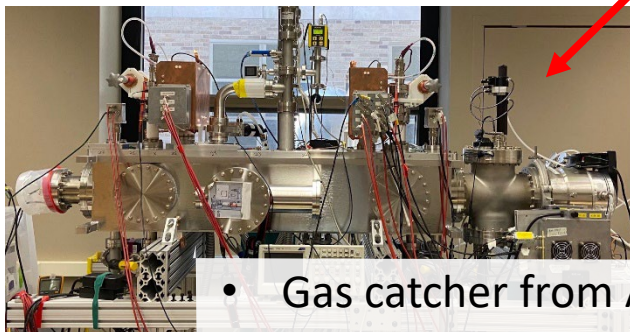
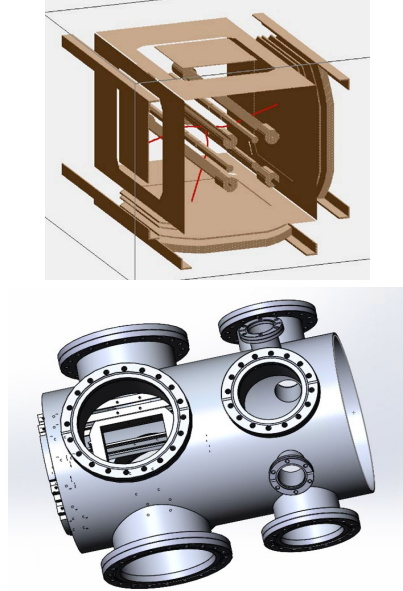
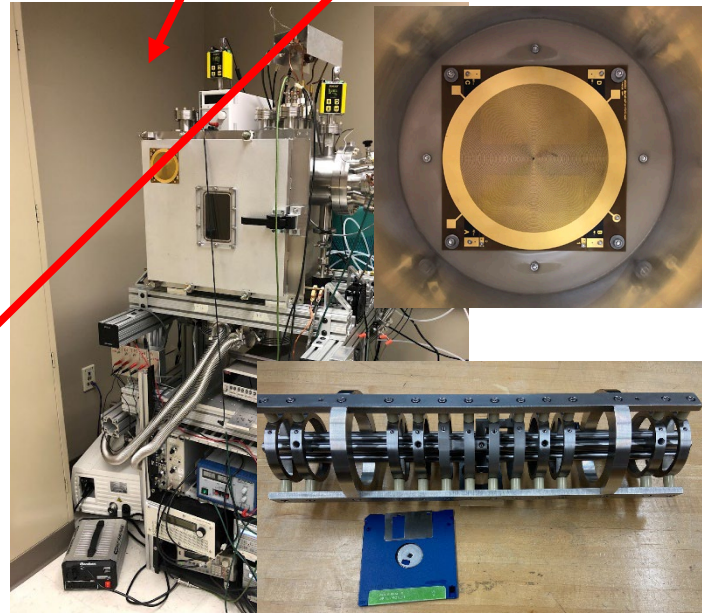
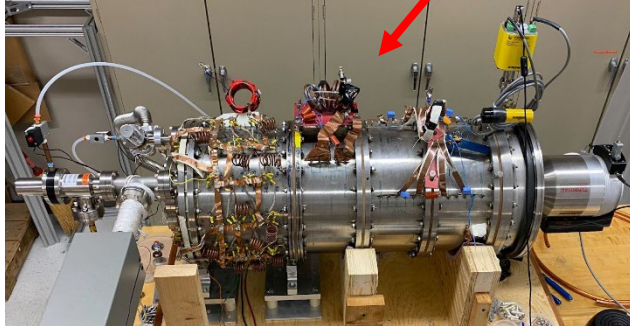
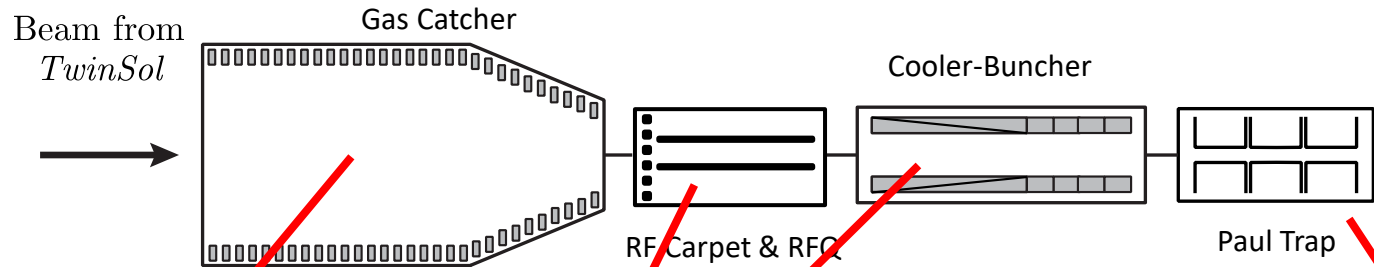

- Gas catcher from ANL: RF/DC & vacuum tested; transport tests underway
- RF carpet tested; ion guide assembled and RF circuit being tested
- Cooler/buncher commissioned
- Paul trap has been simulated and manufactured



Experimental efforts

- Being low- Z , ^{10}C and ^{14}O are the most interesting regarding scalar currents)
- Proton-rich cases to be studied with TAMUTRAP via the kinematic shift of β -delayed proton decays
- Mirror nuclei continue to be improved as an alternate to $0^+ \rightarrow 0^+$ (and of course the neutron, next talk)
- Lifetimes, β - ν correlations with St. Benedict @ Notre Dame
- Lifetimes, branching ratios (fast-tape + HPGe), β - ν correlations (TAMUTRAP) at the Cyclotron Institute

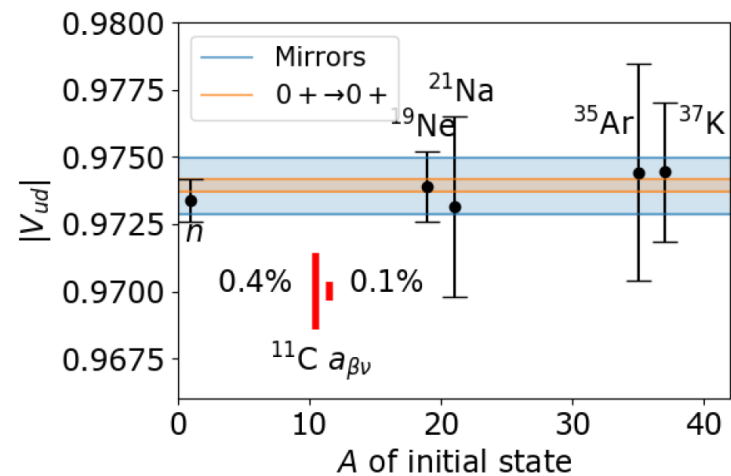
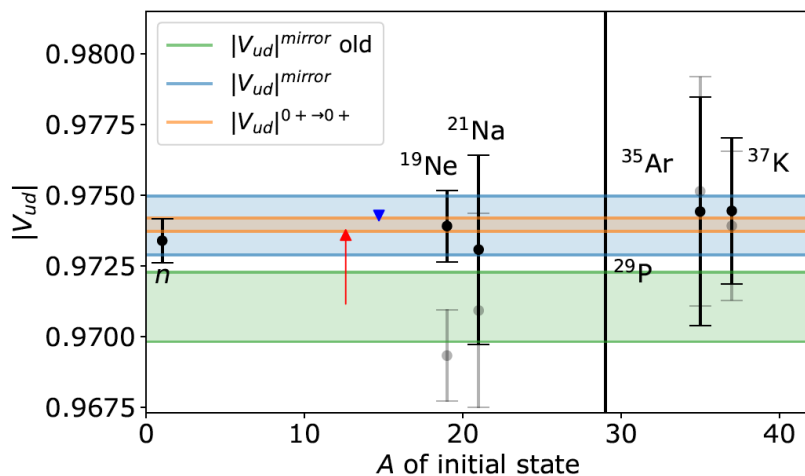

Outline

- CKM matrix unitarity tests
 - ✳ Theory has made huge progress
 - ✳ New experiments targeting low-Z cases, mirror transitions
- Searches for scalar and tensor currents
 - ✳ Spectrum-shape for Fierz
 - ✳ Ion and atom traps
- β decays for neutrino physics
 - ✳ Ultra-low Q-values for direct m_ν measurements
 - ✳ Sterile neutrinos via EC
 - ✳ Reactor antineutrino anomaly

Searches for Scalar/Tensor currents

- Most sensitive probe is b_{Fierz} – linear in exotic couplings
- Cyclotron radiation emission spectroscopy (He6-CRES)
 - ${}^6\text{He}$ (GT), ${}^{19}\text{Ne}$ (F/GT) and ${}^{14}\text{O}$ (F); β^\pm opposite sign in b_{Fierz}
 - Much larger bandwidth needed compared to Project 8
 - Other challenges: other modes, harmonics, wall effects

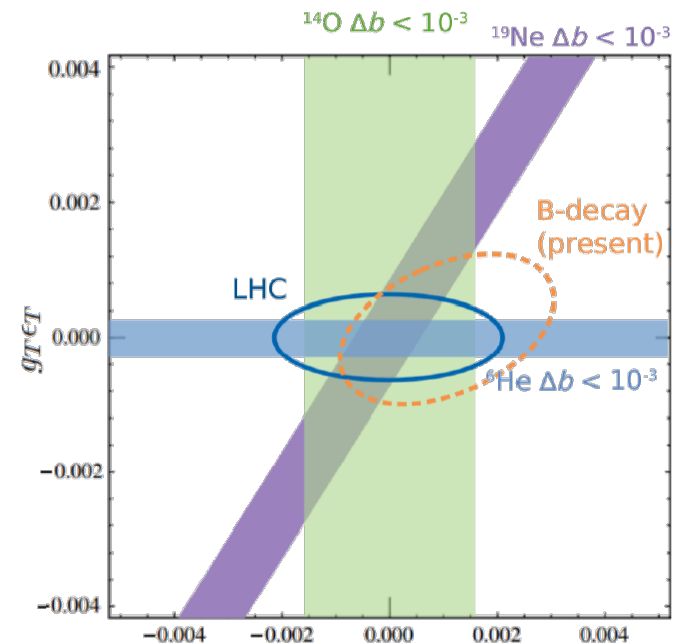
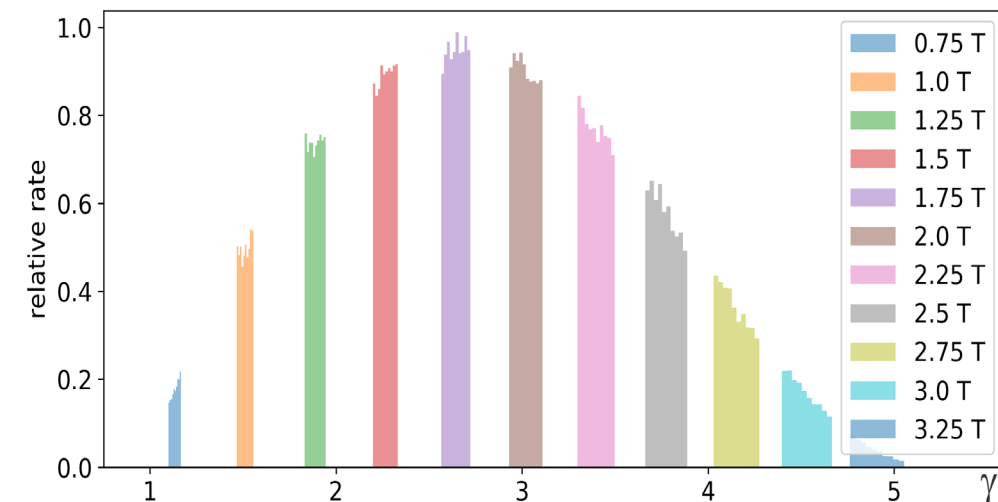

First CRES signals seen

Identify event start frequencies.

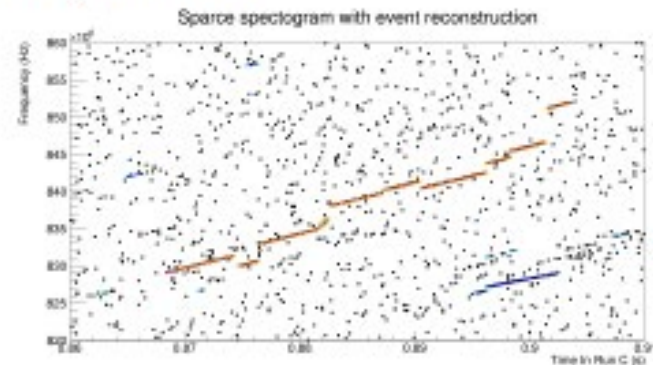
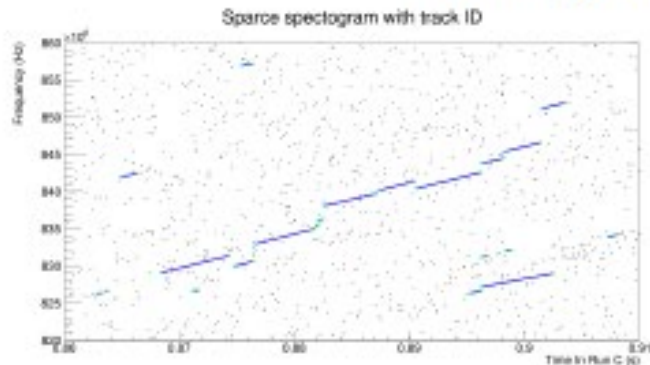

Build a frequency spectrum.

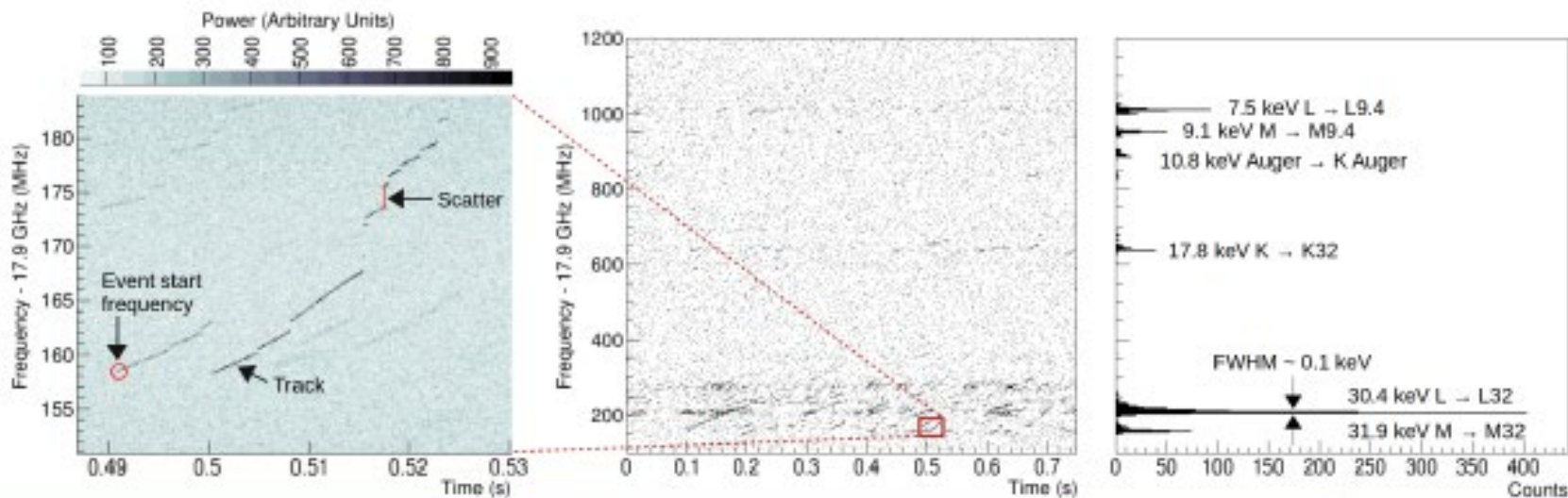

First CREES signals seen

Identify event start frequencies.

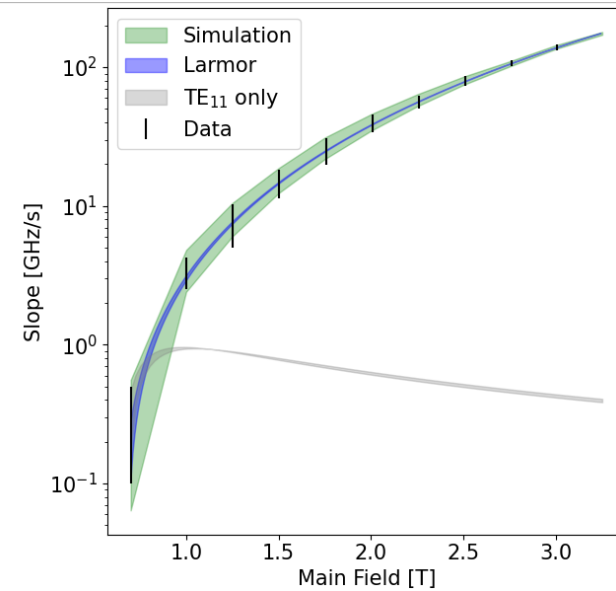
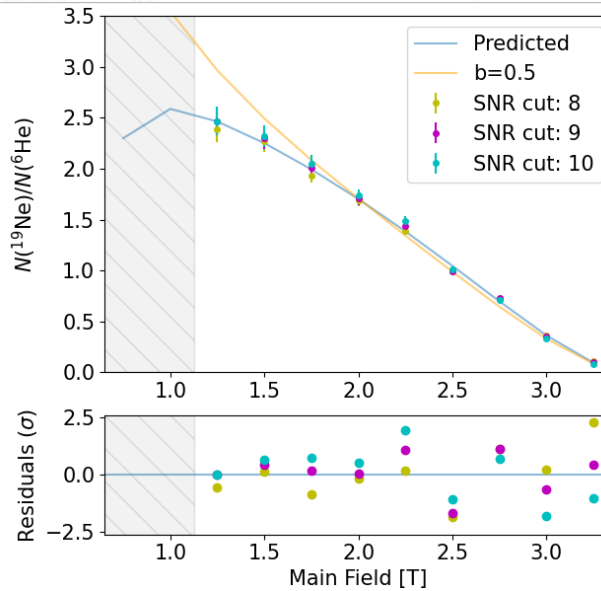
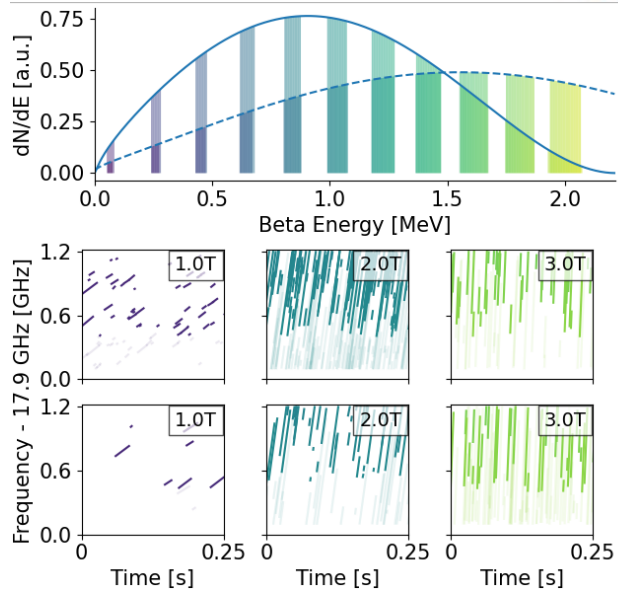
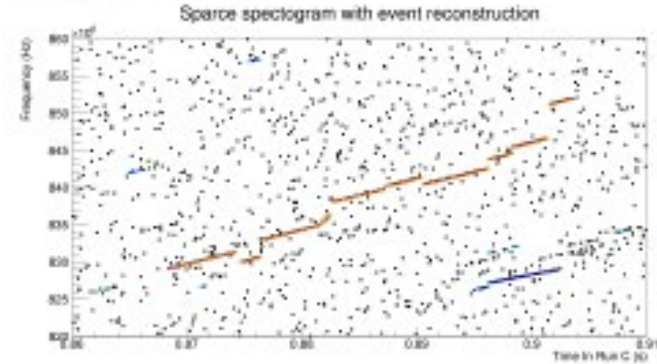
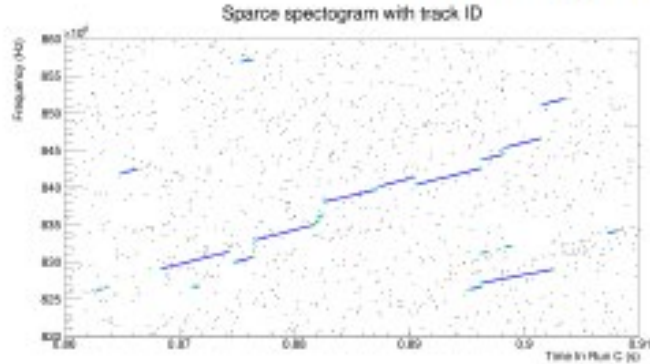

Ion trap + CRES

Wall effects expected to be a limiting systematic

Largest and smallest electron orbits at 2 T

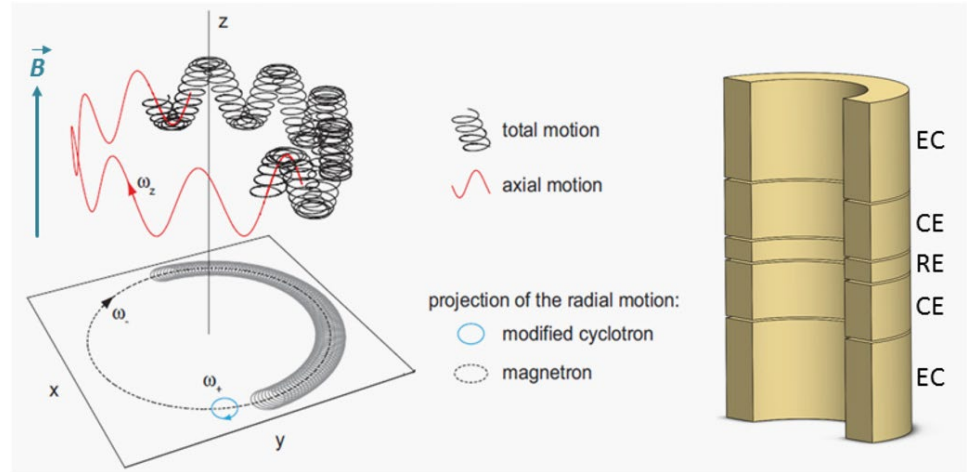
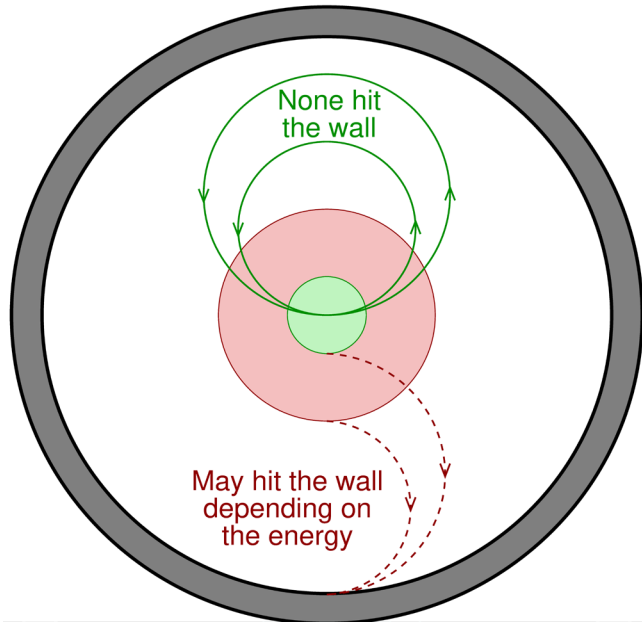

Simulations indicate the rf signal not degraded, and rates *should* be high enough

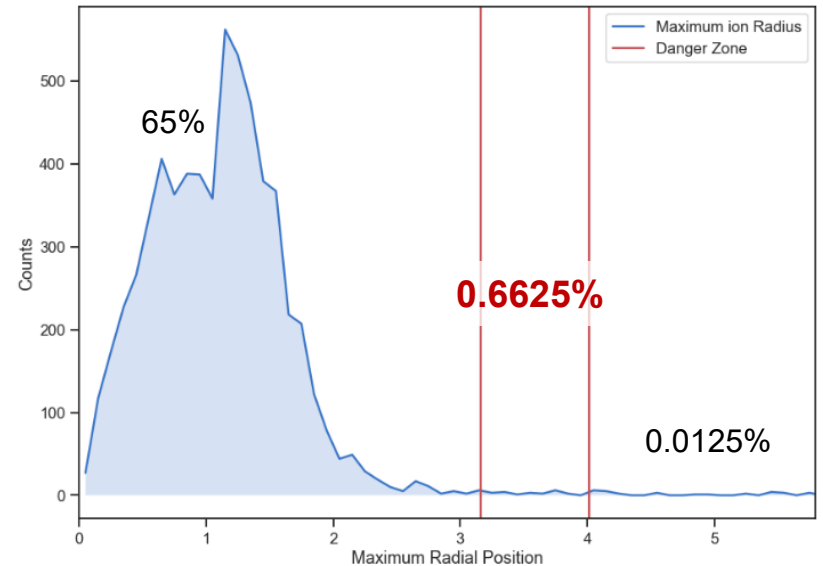

Searches for Scalar/Tensor currents

- Most sensitive probe is b_{Fierz} – linear in exotic couplings
- Cyclotron radiation emission spectroscopy (CRES)
- Implantation at FRIB (Naviliat-Cuncic); next ^{26}mAl

Fragmentation reactions enable choosing the most suitable candidates.



X. Huyan, PhD
thesis 2019

46 MeV/nucleon

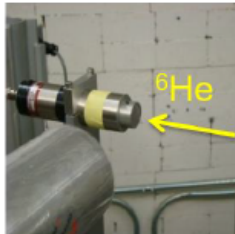

Analysis near
completion.
Expected
 $\Delta b_{GT} \sim 0.01$

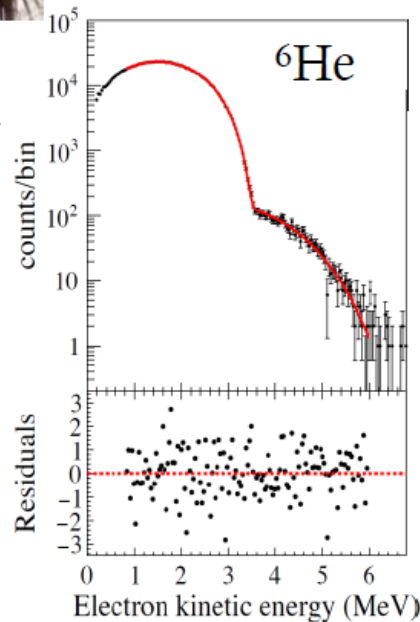

M. Hughes, PhD
thesis 2019

132 MeV/nucleon

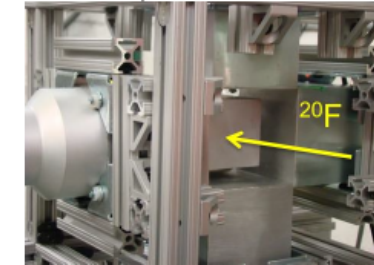

Analysis completed:
reached $\Delta b_{GT} \sim 0.02$
including systematics

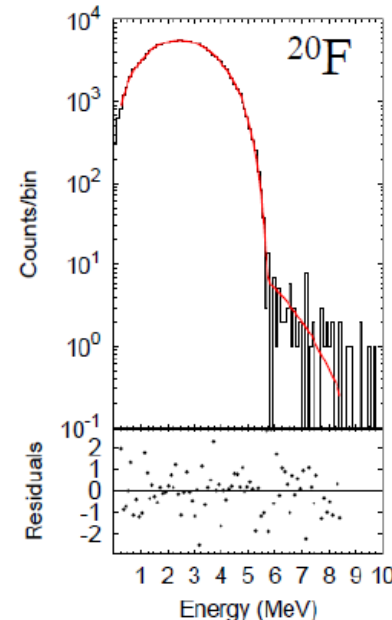

Atom and ion traps for BSM searches

TRINAT has developed some pretty cool techniques

High nuclear polarization

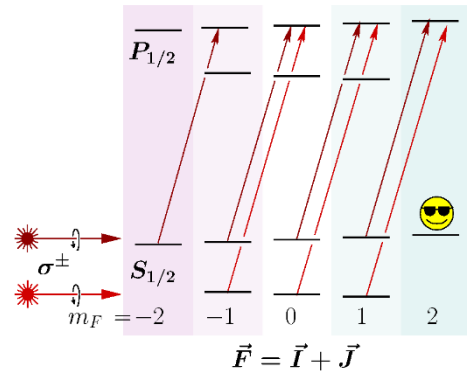

B.Fenker *et al*,
New J. Phys. **18**
(2016)

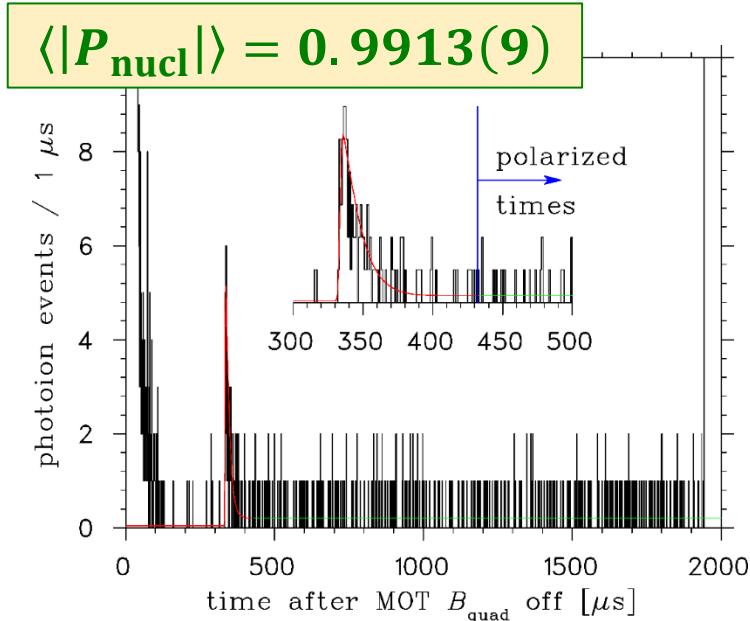

Physics result: A_β to 0.3%

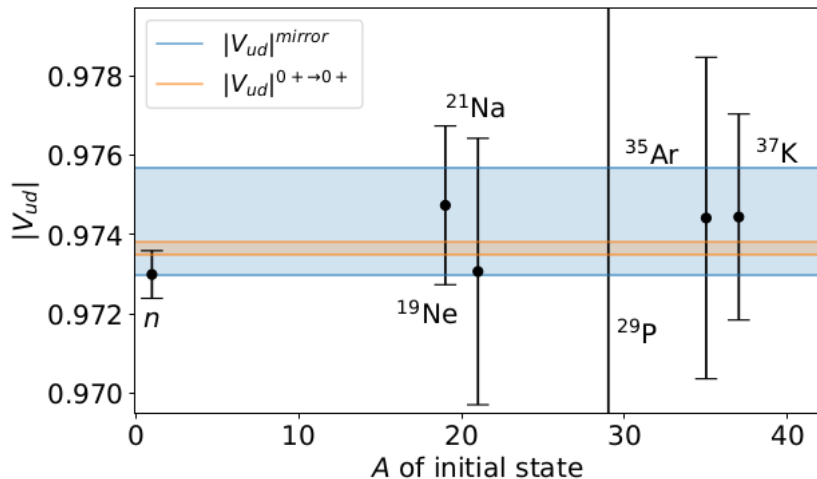

B.Fenker *et al*, PRL **120** (2018)

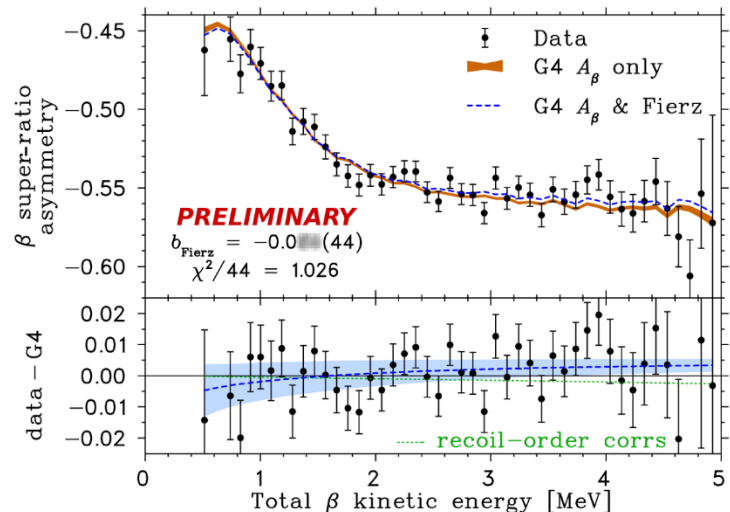

Atom and ion traps for BSM searches

TRINAT has developed some pretty cool techniques

- High nuclear polarization
- Physics result: A_β to 0.3%
- < 0.1% within reach!

^6He at CENPA in collaboration with ANL

Recently published result:

$$\tilde{a} = -0.3268(46)(41)$$

$$\Leftrightarrow 0.007 \leq |C_T/C_A| \leq 0.111 \text{ (90\% CL)}$$

Muller *et al.*, PRL **129**, 182502 (2022)

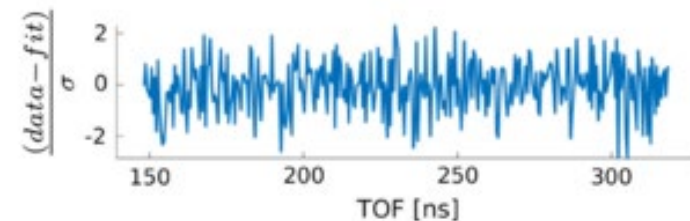
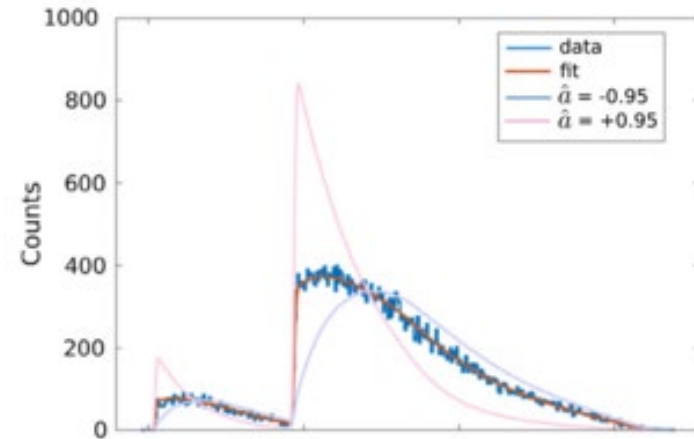
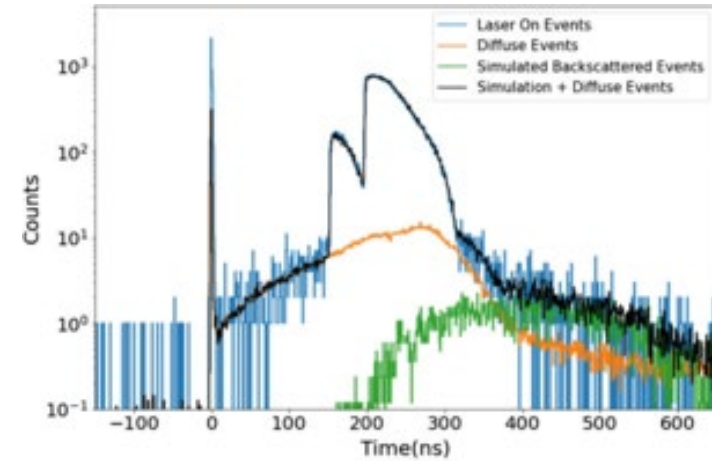

Atom and ion traps for BSM searches

• The beta-decay Paul trap @ ANL (LLNL, ND, ...)

✶ β - α - α coincidence M.T. Burkey *et al.*, PRL **128**, 202502 (2022)

TABLE I. Summary of dominant systematic corrections and uncertainties, listed at 1σ .

Source	Correction	Uncertainty
Theory	Intruder state (added linearly)	+0.0005
	Recoil and radiative terms	0.0015
	α -energy calibration	0.0007
Experiment	Detector line shape	0.0009
	Data cuts	0.0009
	β scattering	0.0010
Total	+0.0005	0.0028

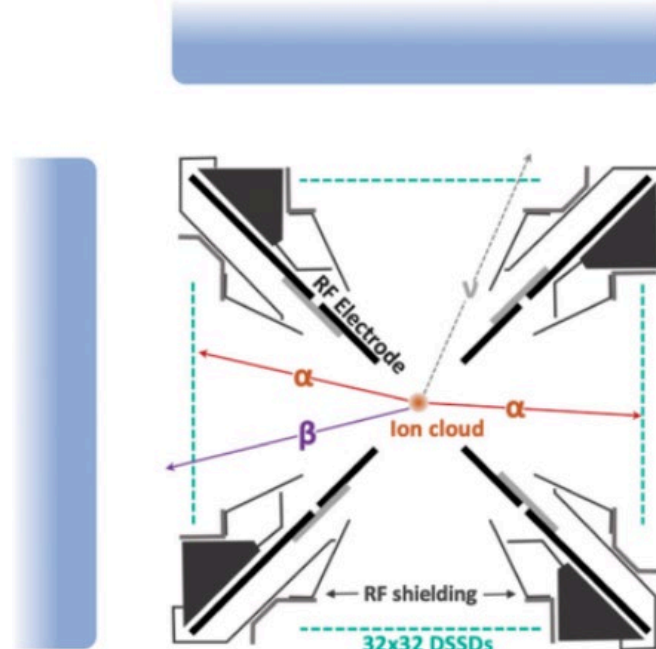

Plastic Scintillator

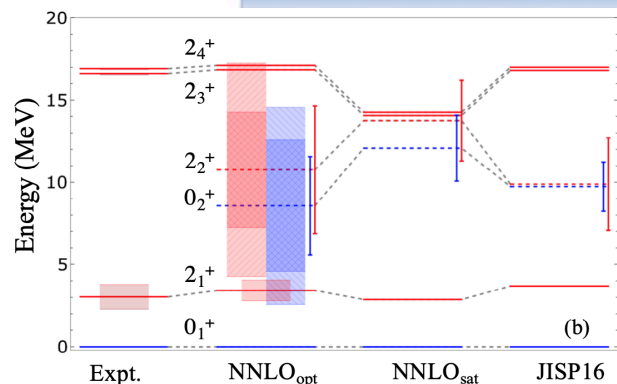

	j_2/A^2c_0	j_3/A^2c_0	d/Ac_0	b/Ac_0
2_1^+	-956 ± 37	-1547 ± 42	10.0 ± 1.0	6.0 ± 0.4
2_2^+ (new)	-10 ± 10	-80 ± 30	-0.5 ± 0.5	3.7 ± 0.4
2_3^+ (doublet 1)	12 ± 5	-60 ± 15	0.3 ± 0.2	3.8 ± 0.2
2_4^+ (doublet 2)	11 ± 3	-65 ± 11	0.2 ± 0.2	3.8 ± 0.2

Atom and ion traps for BSM searches

• The beta-decay Paul trap @ ANL (LLNL, ND, ...)

✳ β - α - α coincidence M.T. Burkey *et al.*, PRL **128**, 202502 (2022)

TABLE I. Summary of dominant systematic corrections and uncertainties, listed at 1σ .

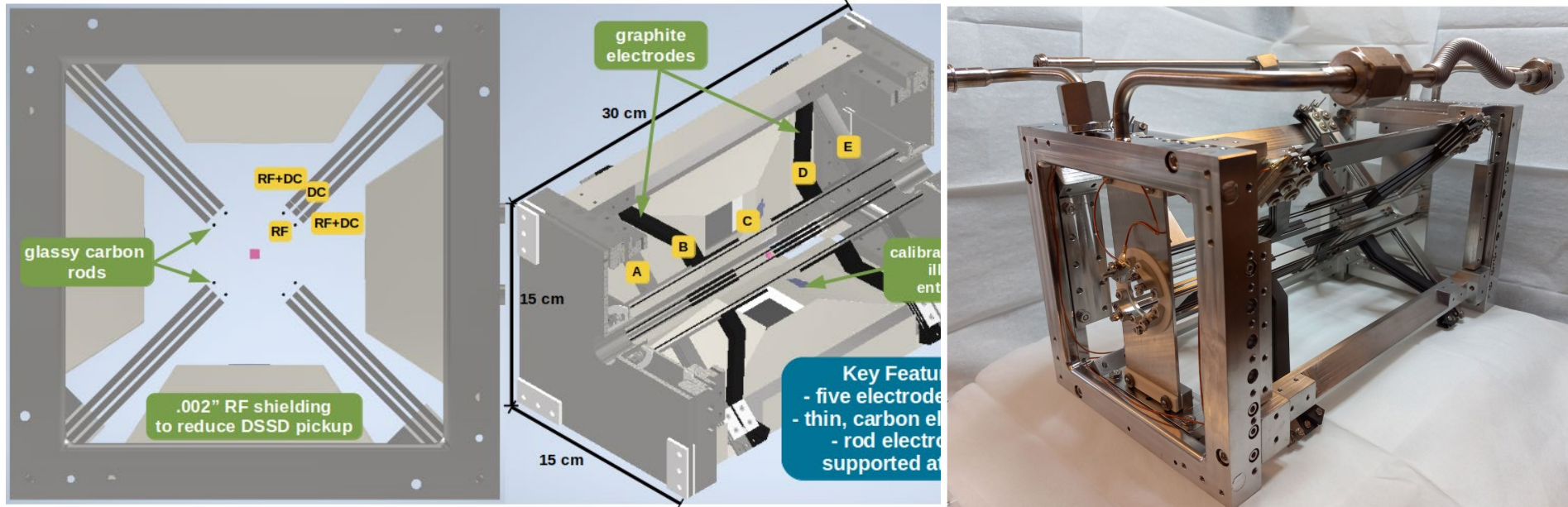

✳ Upgrade will reduce β scattering by $4 \times$. Goal is to improve uncertainty by factor of 2 from recently published result.

G15.00001 and G15.00002 (Sun 10:45 am)

Mass measurements with Penning traps

- TOF-ICR the workhorse for many years
- Phase-image ion-cyclotron-resonance (PI-ICR) improves precision
- LEBIT, CPT (TITAN, JYFLTRAP, ...)
- MR-TOF has really exploded in recent years; every major lab has one now

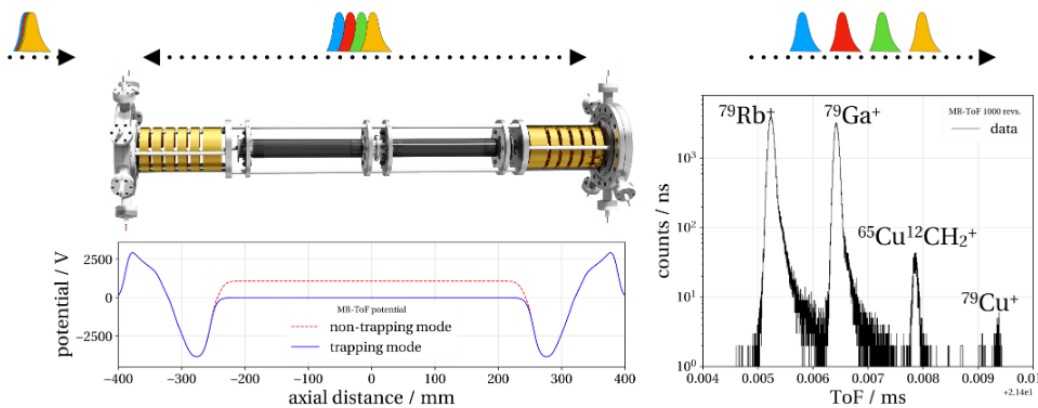
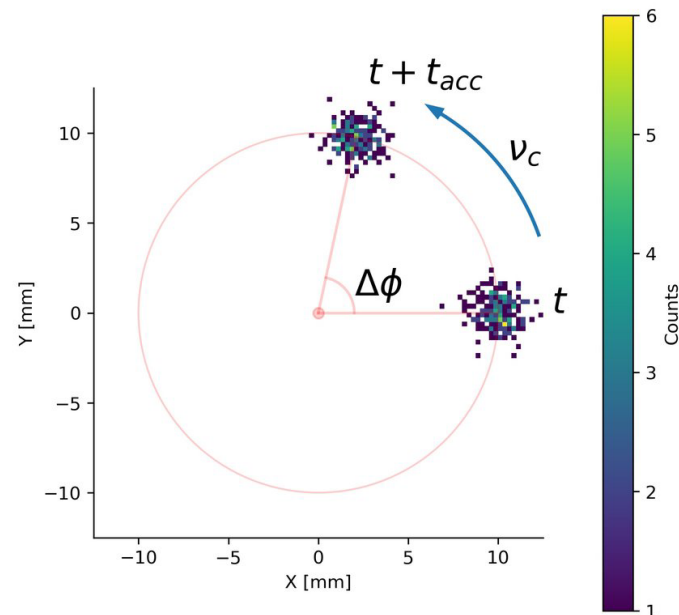

Outline

- CKM matrix unitarity tests
 - ✱ Theory has made huge progress
 - ✱ New experiments targeting low-Z cases, mirror transitions
- Searches for scalar and tensor currents
 - ✱ Spectrum-shape for Fierz
 - ✱ Ion and atom traps
- β decays for neutrino physics
 - ✱ Ultra-low Q-values for direct m_ν measurements
 - ✱ Sterile neutrinos via EC
 - ✱ Reactor antineutrino anomaly

Ultra-low Q value measurements with CHIP-TRAP

Penning traps: Independent β -decay Q value from mass ratio of parent and daughter nuclides

$$Q_{g.s.} = (M_P - M_D)c^2 = (M_P - m_e)(1 - R)c^2$$

$$R = M_D^+ / M_P^+$$

Ultra-low Q value β -decay: $Q_{UL} = Q_{g.s.} - E^* < 1 \text{ keV}$

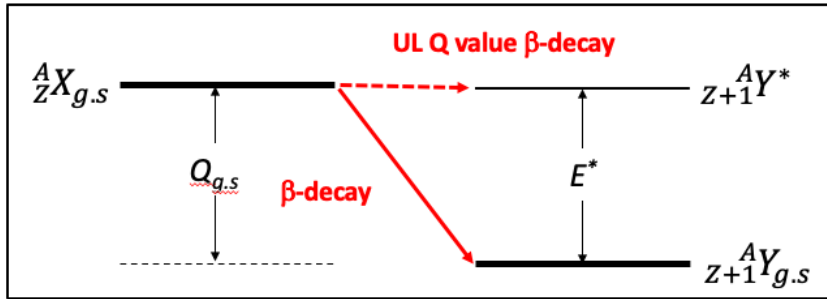

More precise Q values needed to identify candidates

Some promising potential candidates

Isotope	Decay	Forbiddenness	Half-life	Q_{ES} (keV)
^{136}Cs	β^-	Allowed	13 dy	3.7(19)
^{188}W	β^-	Allowed	70 dy	-4.6(32)
^{155}Eu	β^-	1 st Forbidden	5 yr	0.3(16)
^{156}Eu	β^-	1 st Forbidden	15 dy	1.0(37)
^{56}Co	EC	Allowed	78 dy	4.76(55)
^{97}Tc	EC	Allowed	4.2 Myr	-0.1(42)
^{175}Hf	EC	Allowed	70 dy	1.0(26)
^{81}Kr	EC	1 st Forbidden	229 kyr	3.2(15)
^{146}Pm	EC	1 st Forbidden	6 yr	-0.3(45)
^{157}Tb	EC	1 st Forbidden	71 yr	-2.3(14)
^{173}Lu	EC	1 st Forbidden	1.5 yr	1.0(18)
^{183}Re	EC	1 st Forbidden	70 dy	2.5(81)
^{195}Au	EC	1 st Forbidden	186 dy	1.9(12)
^{148}Eu	β^+	Allowed	55 dy	-15(10)
^{105}Ag	β^+	1 st Forbidden	41 dy	5.7(47)
^{144}Pm	β^+	1 st Forbidden	1 yr	-4.8(32)
^{146}Pm	β^+	1 st Forbidden	6 yr	-4.3(45)

2201.08790v2

Q values for forbidden β -decays

High-precision β -spectra provide:

- Possibility to extract g_A via spectral shape method.
- Data for radionuclide metrology (applications in nuclear medicine and nuclear power).
- Improved knowledge of rare decays – potential backgrounds in $0\nu\beta\beta$ and dark matter detectors.
- Improved data for testing theoretical calculations.

Penning trap Q values provide:

- Direct test of systematics via comparison of Q value and end point energy.
- Precise Q value for phase space factor calculations.

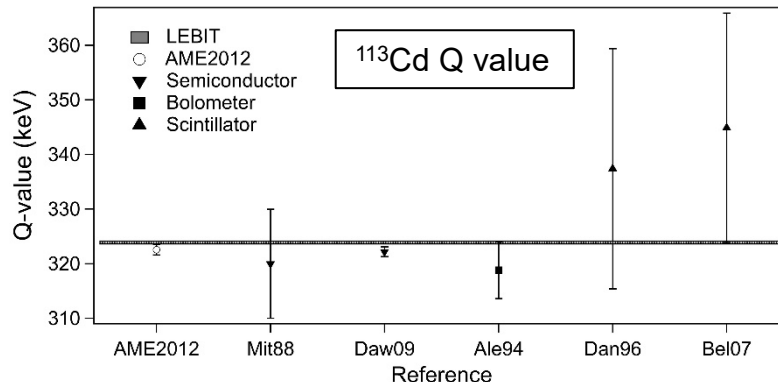

BSM with Rare-Isotope Doped Superconductors



- Embedding radioactive atoms into superconducting tunnel junctions (STJs)
- Measure eV-scale decay recoils
- Search for keV – MeV sterile neutrinos

^7Be implantation at TRIUMF-ISAC

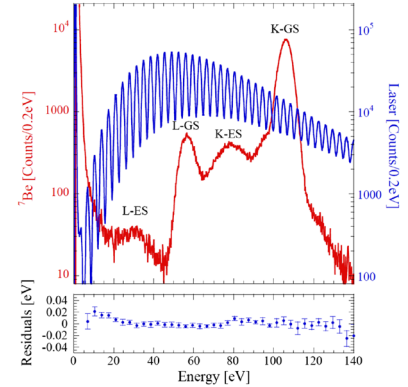
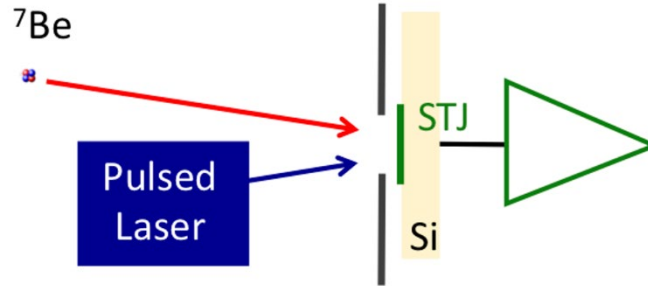

Ta, Al, and Nb-based STJ Sensors

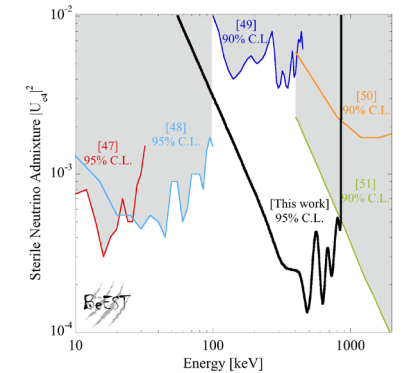
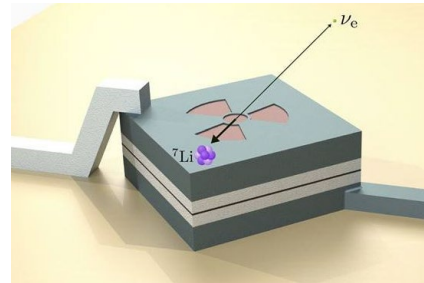



A. Samanta *et al.*, Phys. Rev. Applied (*in press*) (2022)
 S. Friedrich *et al.*, J. Low Temp. Phys. (*in press*) (2022)
 C. Bray *et al.*, J. Low Temp. Phys. (*in press*) (2022)
 K.G. Leach *et al.*, J. Low Temp. Phys. (*in press*) (2022)
 S. Friedrich *et al.*, Phys. Rev. Lett. **126**, 021803 (2021)
 S. Fretwell *et al.*, Phys. Rev. Lett. **125**, 032701 (2020)
 S. Friedrich *et al.*, J. Low Temp. Phys. **200**, 200 (2020)

HUNTER

Heavy Unseen Neutrinos by Total Energy-momentum Reconstruction

 Kinematic reconstruction of m_ν in individual EC decays of ^{131}Cs atoms at rest

-  Kinematic reconstruction - not an oscillation experiment. Measure all decay product momenta & reconstruct missing neutrino mass event-by-event
-  ^{131}Cs is at rest - held in a Magneto-Optical Trap and laser cooled to $20\ \mu\text{K}$
-  Reaction Ion Microscopes measure recoil nucleus and Auger electron directions & momenta with high efficiency & resolution 0.1-1%

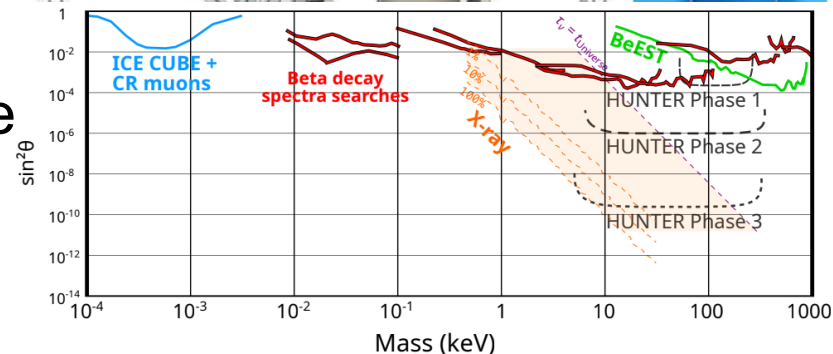
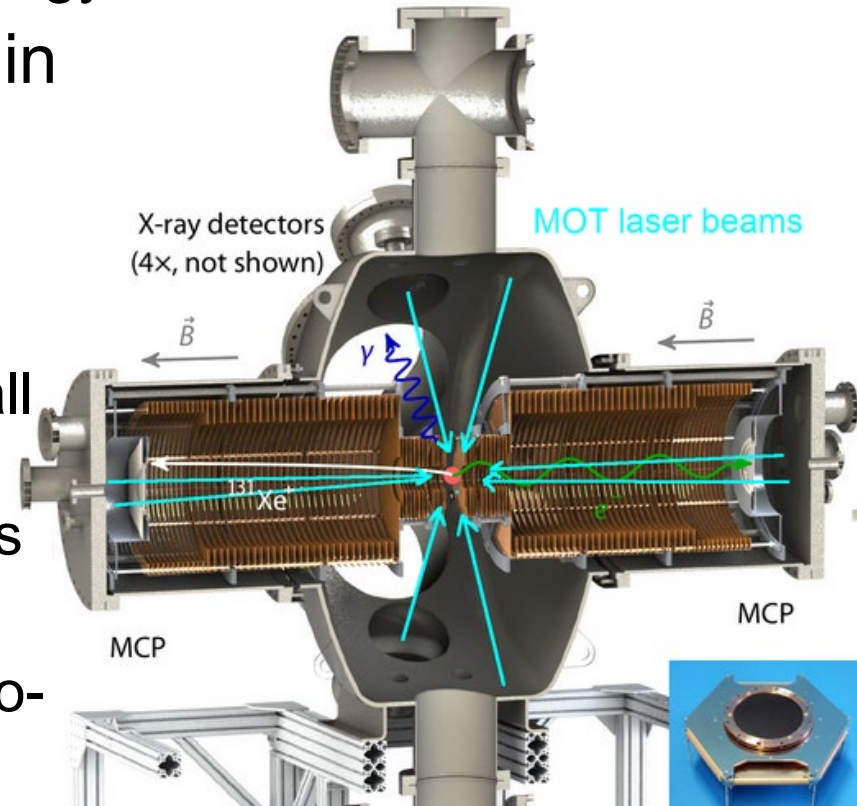

Measuring β Transitions in Complex β Decays

Currently only β energy spectra of **very** simple β decays are studied

ORNL-LSU collab are developing the **β -Spectrum Module (β SM)** with ORNL's MTAS Detector

to measure entire β -energy spectra for each individual β -decay transition

Isolate Individual β transitions with $\sim 99\%$ efficiency

Permits extraction of various allowed and 1st-forbidden β shapes all from the same parent

- Improve reactor antineutrino flux predictions beyond the 5% level down to the $\sim 1\%$ level by directly measuring β -shape factors of individual β transitions
- Expand by hundreds the number of important **β -decay shape factors** that can be studied
- Allows access to g_V and g_A , nuclear matrix elements
- Can minimize systematics by measuring different β transitions from the same β -decaying parent

Simulated β SM Response to ^{93}Y β Decay

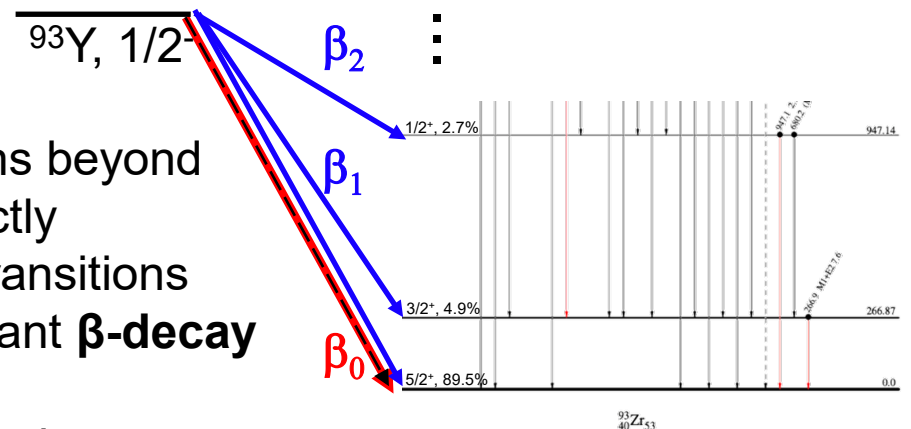
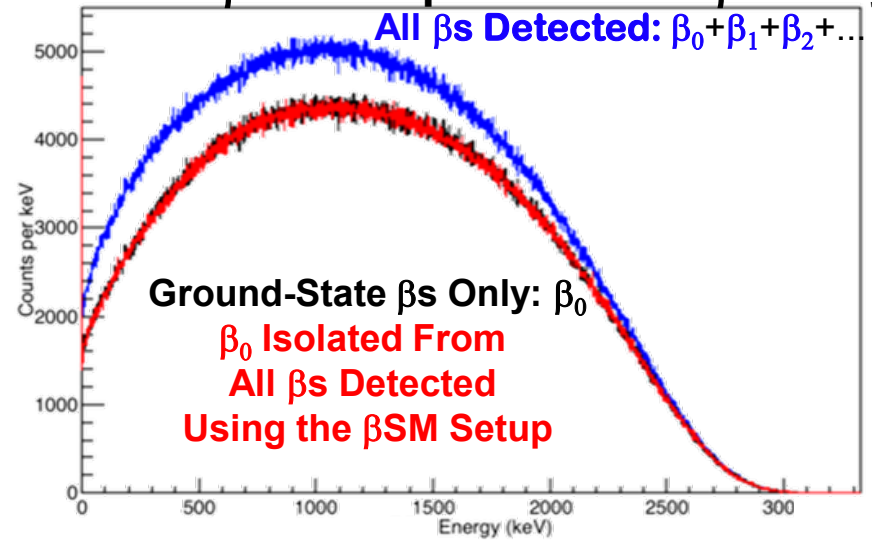

OAK RIDGE
National Laboratory

LSU

Work supported by Nuclear Data FOA-2440, Rasco et al., 2022

Summary

Why are the next few years interesting:

- ✳ Increased precision of V_{ud} could confirm CKM unitarity deficit
 - Precision of V_{ud} from neutron decay is gradually catching up. Comparisons between V_{ud} from different determinations could possibly unveil new anomalies.
 - It is possible for the first time to compute quantities such as δ_{NS} and δ_C with rigorously-quantified theory uncertainties
- ✳ Cutting-edge technologies opening up new opportunities for significant increase in precision for BSM searches and (sterile) neutrino searches (CRES, quantum sensors, traps, ...)

What might get accomplished during this LRP:

- ✳ Formation of a topical group (e.g. VudU, “Vud unitarity” alliance) to facilitate collaborations, especially between experiment and theory
- ✳ Compute δ_{NS} and δ_C with ab-initio methods for light and medium nuclei; improve recoil-order corrections
- ✳ Experimental programs maturing to reach 0.1% and beyond, and orders of magnitude on sterile neutrinos

Poised for **great** results to come out of this LRP

In case I run out of time (I didn't?!?!)

- Start and end with the White Paper recommendations:
 - Experimental + theoretical alliance for V_{ud} and CKM unitarity
 - Investing in small- and mid-scale projects
 - Establishing support for nuclear theory
 - Developing cutting-edge techniques
 - Promote diverse and inclusive environment, and better support students
- Thanks for input (apologies to all)
 - Maxime Brodeur, Drew Byron, Jason Clark, Leendert Hayen, Kyle Leach, Charlie Rasco, Matt Redshaw, Nick Scielzo, Chien Yeah Seng, Louis Varrian, and everyone on the nuclear β decay White Paper
 - DOE and NSF for support



U.S. DEPARTMENT OF
ENERGY

Office of
Science

