

# Particle Physics Instrumentation and experiments

**Christian Bohm**  
**Stockholm University**

## **Outline**

Physics Background

LHC and its detectors

ATLAS and its subdetectors

Future Developments

# Introduction

We study new physics by **colliding high energy particles**

New particles can be produced in these collisions if the energy is sufficiently high.

If we collide single protons the probability (cross section) for this is extremely small.

You need many collisions to increase the probability – need **high luminosity** and **many repetitions**

To release a lot of energy there must be a head collision.

The protons contains three quarks, so only must the protons collide head-on but also their constituents.

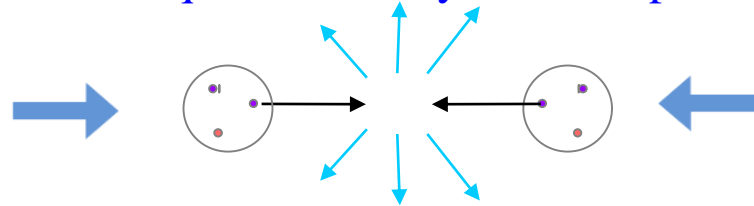

After doing this for some time, we look for unusual interesting events.

And not only one, we want **many** such events to believe the results

Thus,

- **We must collide a large number of protons each time – use high luminosity proton beams**
- **We must repeat collisions many times – use high collision rates**

# Why we need to record many events

To determine if our  $N$  observed events contain new data that constitute a discovery we must determine if the data could be produced by combinations of well-understood events. The probability for such events is the background  $B$ .

For  $N$  to be a discovery,  $N$  must be significantly larger than  $B$

For example if  $N$  is 80 and  $B$  is 64 then  $\sigma(B)$  is 8 (assume Poisson distribution  $\sigma^2=N$ )

$N$  is  $2\sigma$  above i.e. 2% probability that  $N$  is just random noise

If we measure 4 times as long  $N'$  will be at 320,  $B'$  is 256 and  $\sigma(B')$  16 i.e. about  $4\sigma(B')$  above i.e. 0.004% that it is random noise. Much smaller probability that  $N'$  is due to random noise but this is not enough to claim a discovery.

$5\sigma$  (0.00002% it is random noise) is often required for discovery.

**The significance of  $N$  will grow after more measurements if it is a real effect, but the significance could also decrease or even disappear if it is not.**

**There are many  $3\sigma$  effects that have disappeared, but a  $5\sigma$  must have been a  $3\sigma$  at some point (750GeV diphoton excess)**

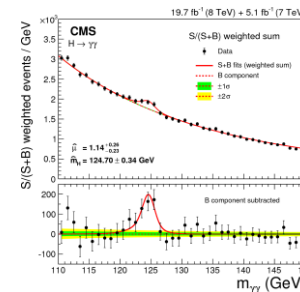
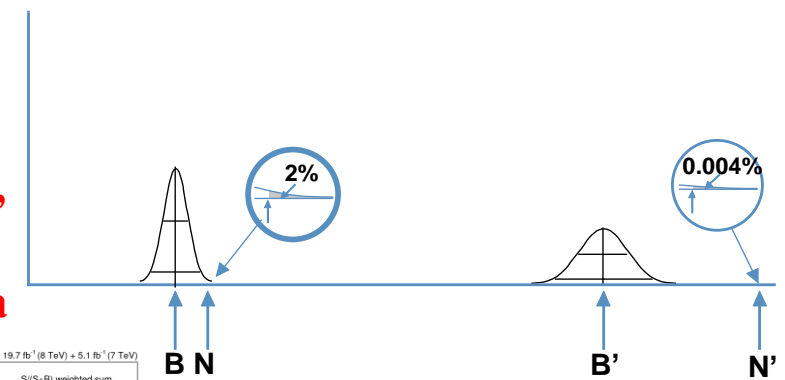
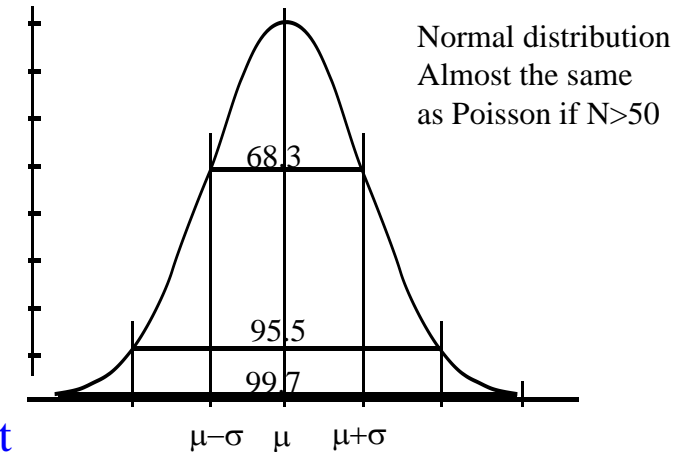

# Beyond the Standard Model

We have a theory, the **Standard Model**, to explain much of the particle physics we have observed, but not all. The task is to explore **Beyond Standard Model (BSM)** physics

One way is to find new observational results that cannot be explained by the Standard Model  
Better precision (higher luminosity and longer measuring time) increases the probability for finding deviations

Another way is to propose theories that agrees with existing experimental results but also predicts new results that can be tested with experiments

Some potential BSM theories predict super symmetric partners to all normal particles – **none of which have been seen so far**

To progress we need to know where the Standard Model fails

We need more data and/or higher energies

# Detectable Standard Model particles

The **Standard Model**, explains most of the particle physics we have observed (but not all).

The most basic constituents are:

**Leptons, quarks and bosons**

These can be created in collisions in high energy physics experiments at accelerators, but short lived particles decay before they reach the active parts of the detector. They can only be deduced from their decay products.

We can detect **electrons**, (positive) **muons** and their anti-particles (**positrons** and negative muons)

The only boson we can detect directly is the **photon**.

We can detect composite particles (charged and uncharged) formed by quarks, called **hadrons** but have problems identifying them.

The hadrons can be **mesons** and **baryons** such as **protons** and **neutrons**

# Jets

In the standard model there are 6 types of quarks and 6 types of antiquarks.

Free quarks are never seen. You only see combinations of them, hadrons.  
They can combine into baryons (3 quarks) or mesons (a quark-antiquark pair).

One way to **illustrate** the quark behavior is to see them as **string ends**.

A mesons will then be modelled as:  and a baryon (e.g. a proton) as:  or 

If you stretch a meson, i.e. trying to move the quark and antiquark away from each other, the string breaks.

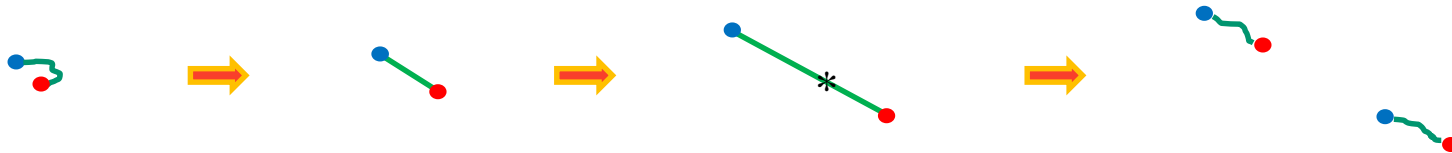

**Forming two strings with two new string ends, a new quark-antiquark pair, and thus two mesons**

# Jets

If the quarks in a meson separate with a high kinetic energy there will be multiple string ruptures a **jet** of hadrons

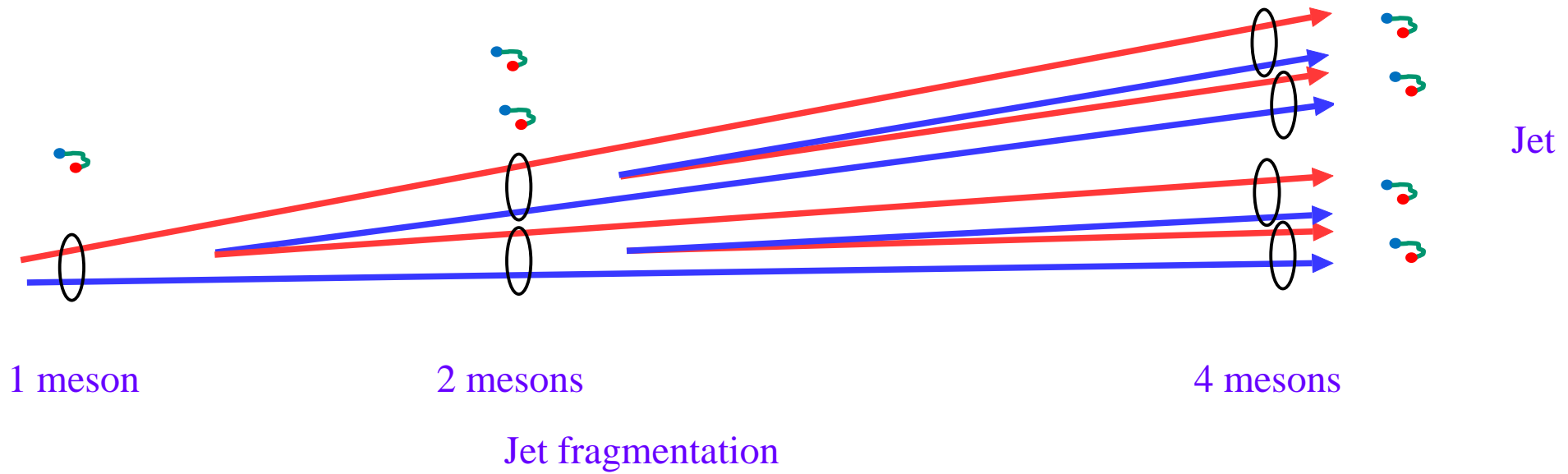

**Whenever a quark tries to escape a jet is formed**

# Short lived particles

You have to infer the existence of short lived ( $< 10^{-10}$  sec) particles by recording the disintegration products

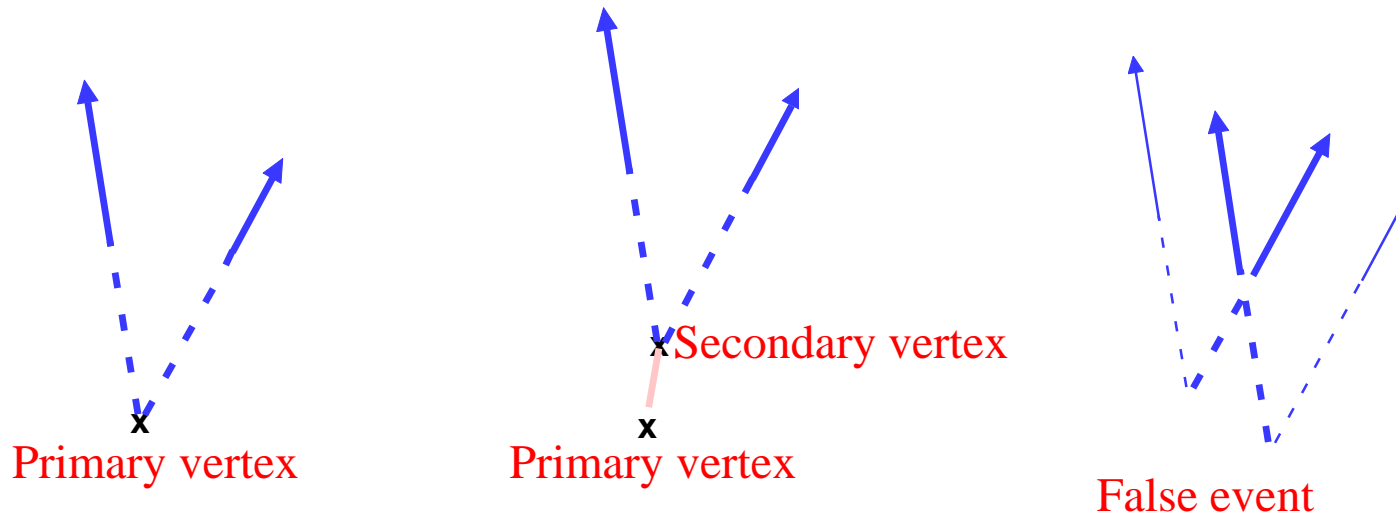

But this opens for mistakes:

If  $A \rightarrow B, C$  and you record  $B$  and  $C$  it is not **certain** they came from the same  $A$ . They might have come from **different** processes

**Need to know the direction with high precision,** to be able to identify if it is a secondary vertex



# Missing Transverse Momenta (Energy)

The center of gravity of all particles created in an explosion stay at the collision center

The vector sum of all momenta in the COG system is 0

Same thing applies to the transverse projection

If one particle is not detected there will be a missing transverse momenta

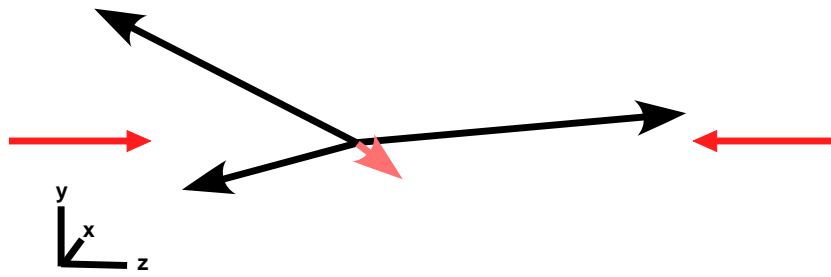

3D

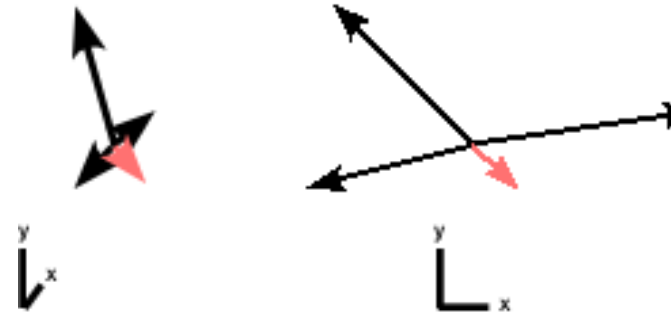

Transverse projection

Missing transverse momenta can be due to:

- Particles that cannot be detected (e.g. neutrinos) or failing detector elements
- The detector should be hermetic

# Colliders

One solution to get high luminosity and high repetition rate is to circulate the particles (e.g. protons) in two ring accelerators that cross in regions where the particles can collide

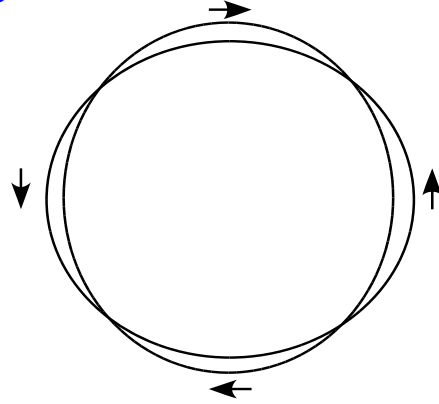

**Most protons will pass through and continue to recirculate, but some would collide** (along with collisions with rest gas)  
**Eventually all protons will be lost, but before that they will pass each other many times**

A better solution is to group the protons in bunches and let the bunches collide

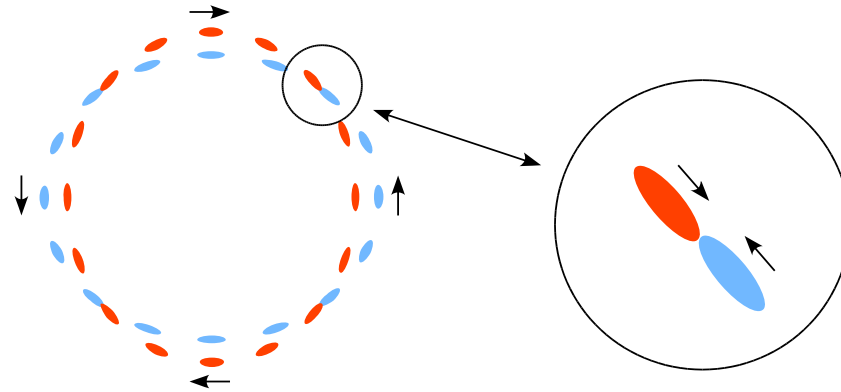

# The Large Hadron Collider

27km circumference double ring collider

13 TeV (6.5+6.5) – 0.999999991 times  $c$ , i.e. 3m/s less than  $c$

4 interaction points with detectors – ATLAS, CMS, LHC-B and ALICE

1600 superconducting magnets (up to 9T) to bend and focus the beams

$10^{34}$  protons/cm<sup>2</sup>/sec focused into 16  $\mu$  beams that collide in the interaction points

Bunches with about  $10^{11}$  protons each collide every 25 ns

~ 20 non-elastic collisions per bunch crossing

The total beam energy is 562 MJ – melts 2 ton copper

Start of operations 2010 (2008)



# The Large Hadron Collider

Insulation vacuum at  $10^{-6}$  mBar in a volume of  $15000\text{m}^3$

Beam pipe vacuum  $10^{-10}$  mBar (as on the moon)



## CROSS SECTION OF LHC DIPOLE

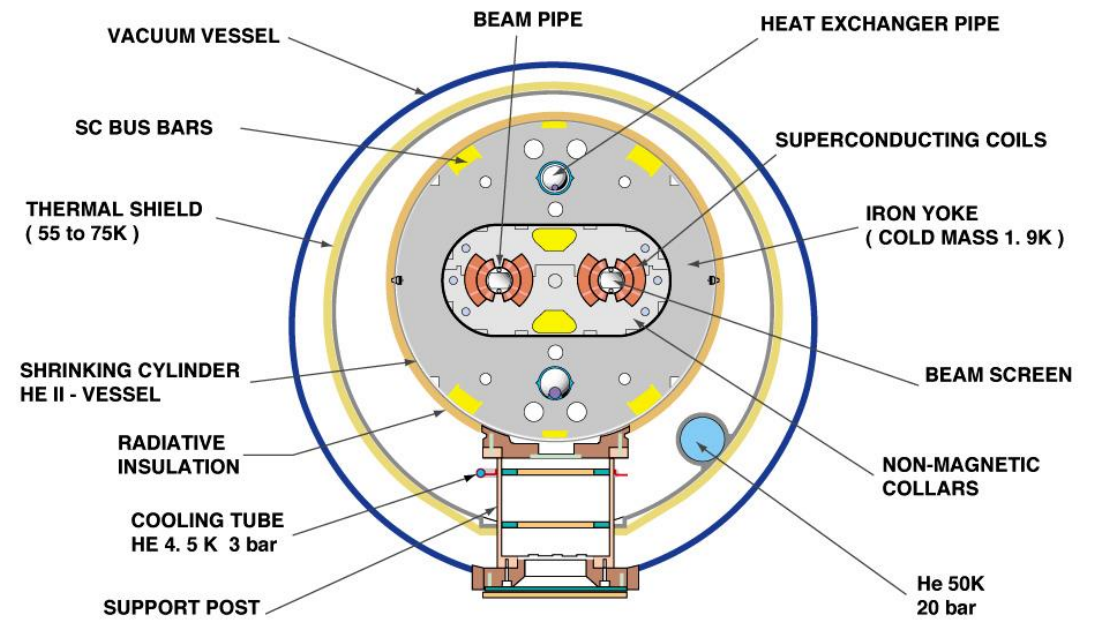

CERN AC\_HE107A\_V02/02/98

# The CERN Accelerator Systems

## A hierarchical system of accelerators

Linac 2 → PS Booster → PS → SPS → LHC  
 50 MeV      1.4 GeV      25 GeV    450 GeV    6.5 (7) TeV

One or two injections into LHC per day

450 GeV injected protons accelerate to 6.5 TeV in 20 minutes

Aim for 7 TeV 2021

## CERN Accelerator chronology

Linac 1 and PS started 1959

PS Booster started in 1972

SPS started in 1976

Linac 2 started in 1978

LEP started in 1989 reached 104+104 GeV

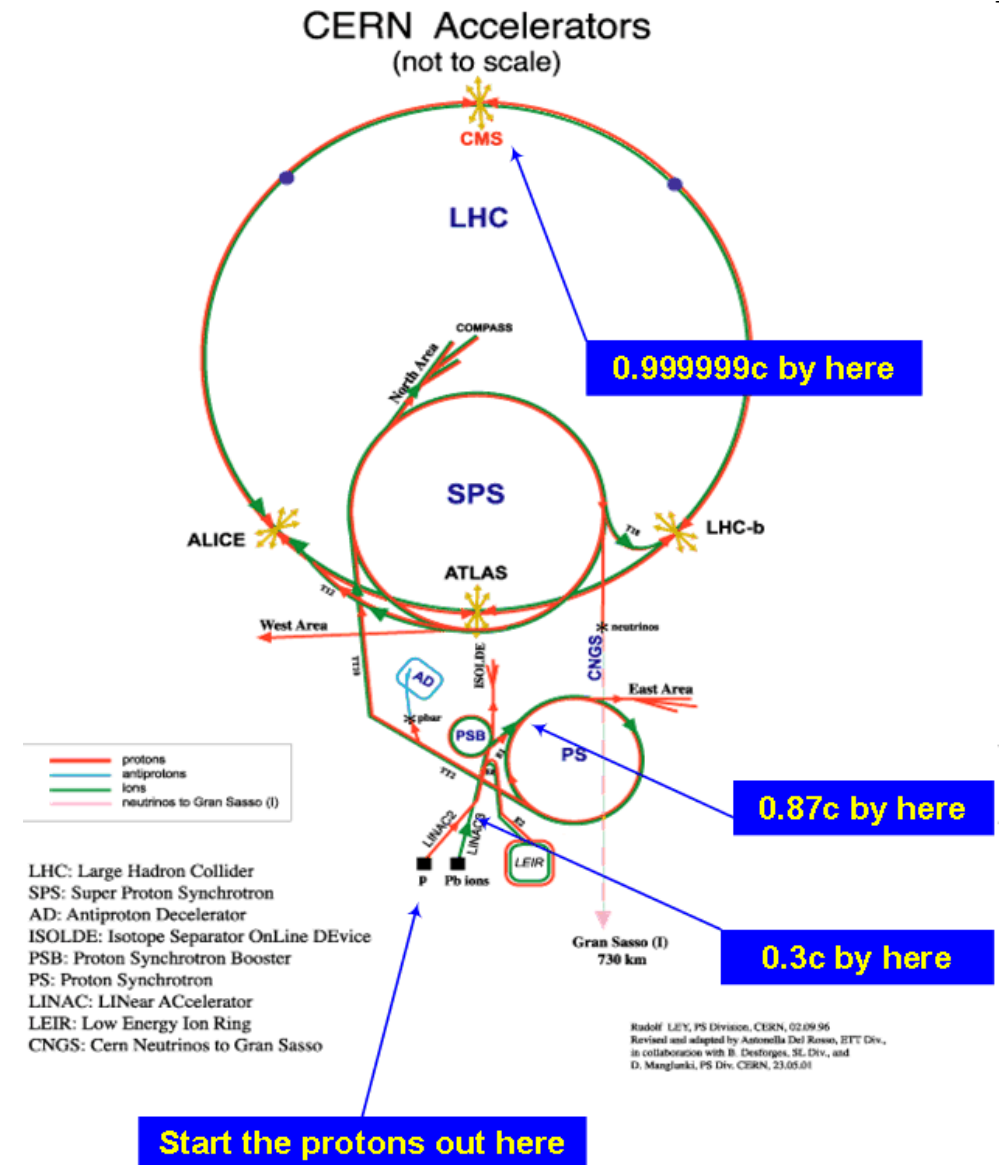

# Detector and Subdetectors

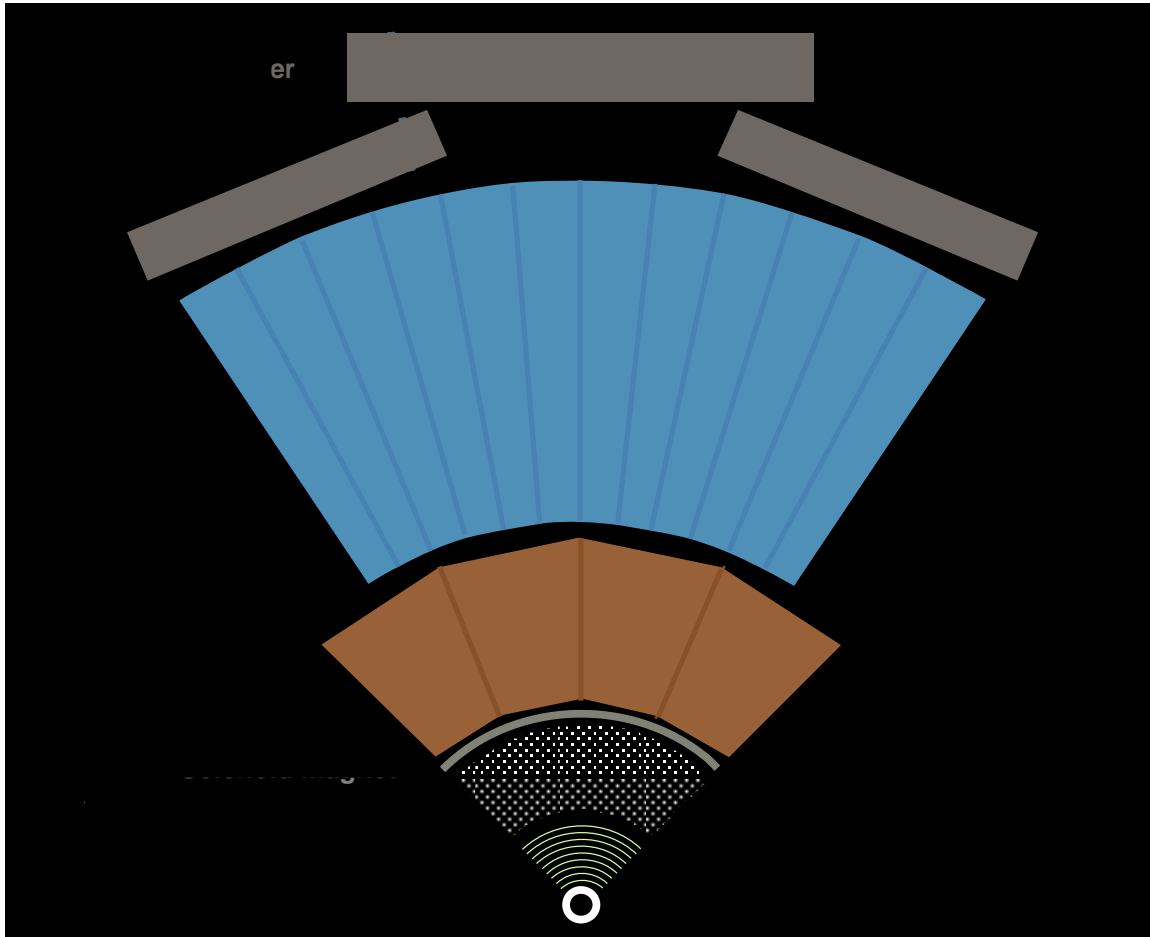

All short-lived particles decay before entering the detector itself

Remaining particles:  $e^-$ ,  $e^+$ ,  $\gamma$ , hadrons (p, n..., jets),  $\mu^+$ ,  $\mu^-$ ,  $\nu$ , ?

Onion-like with multiple subdetector and magnet shells:

Inner detector (tracker) with Pixel, SCT and TRT  
to find charged particle tracks

Solenoid magnets to deduce charge and momentum

Electromagnetic calorimeter to measure e/m tracks and energy

Hadron calorimeter to measure hadron and jet tracks and energy

Muon detector to detect muon tracks and momentum

# Identifying the collision event

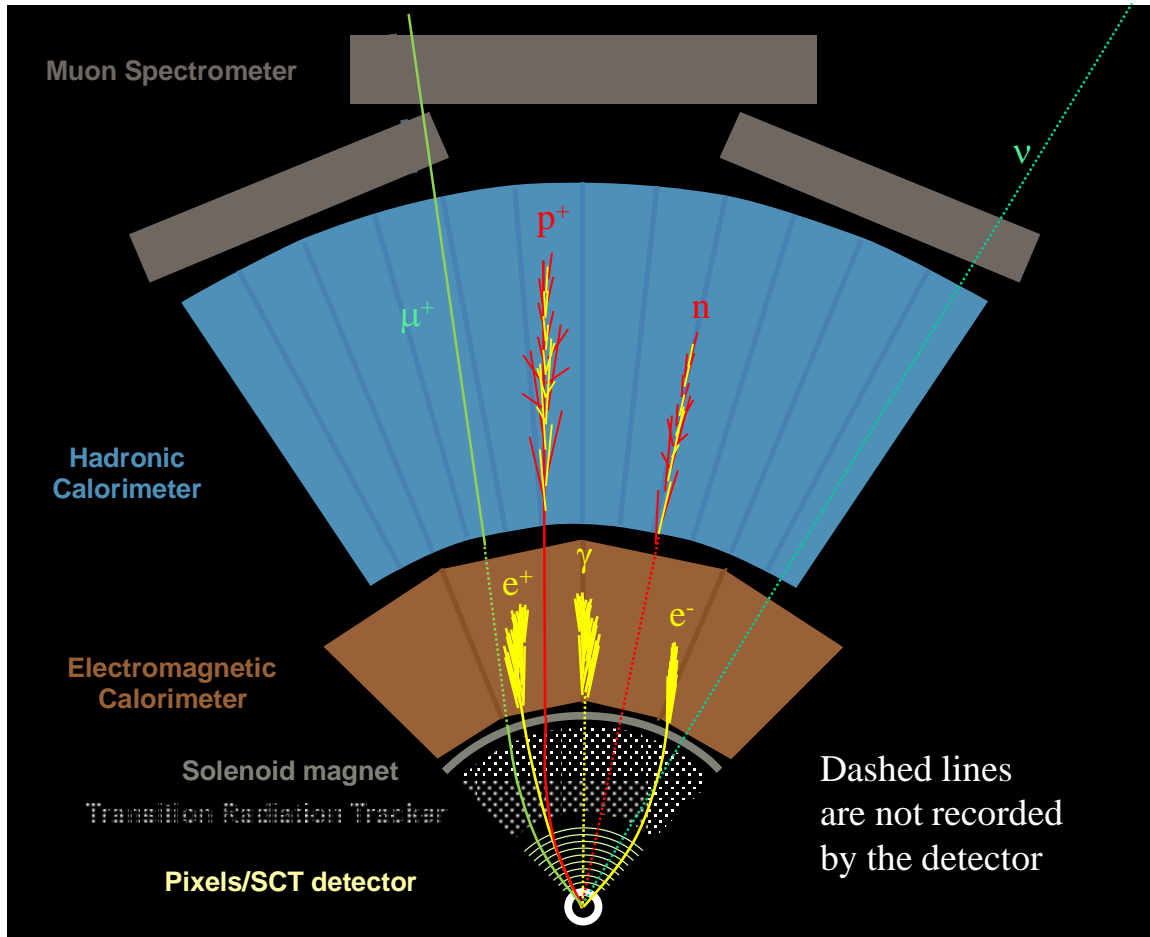

An electron ( $e^-$ ) leaves a track in the inner detector with negative (here counter clockwise) curvature and showers and is absorbed in the electromagnetic calorimeter

An higher energy positron ( $e^+$ ) leaves a positive smaller curvature

A photon ( $\gamma$ ) leaves no track in the inner detector

A positive muon ( $\mu^+$ ) leaves a positive curvature track in the inner detector, a weak track in the hadron calorimeter and a signal in the muon spectrometer

A proton ( $p$ ) leaves a positive curvature track in the inner detector, a track in the e/m calorimeter and a track in the hadron calorimeter

A neutron ( $n$ ) leaves no track in the inner detector, a track in the e/m calorimeter and a track in the hadron calorimeter

A neutrino ( $\nu$ ) does not leave any tracks at all

# Identifying the collision event

Group particles from the same interaction point – could be outside beam pipe

Deduce source particle:

$$e^+e^- \rightarrow Z$$

$$\mu^+\mu^- \rightarrow Z$$

$$2Z \rightarrow H$$

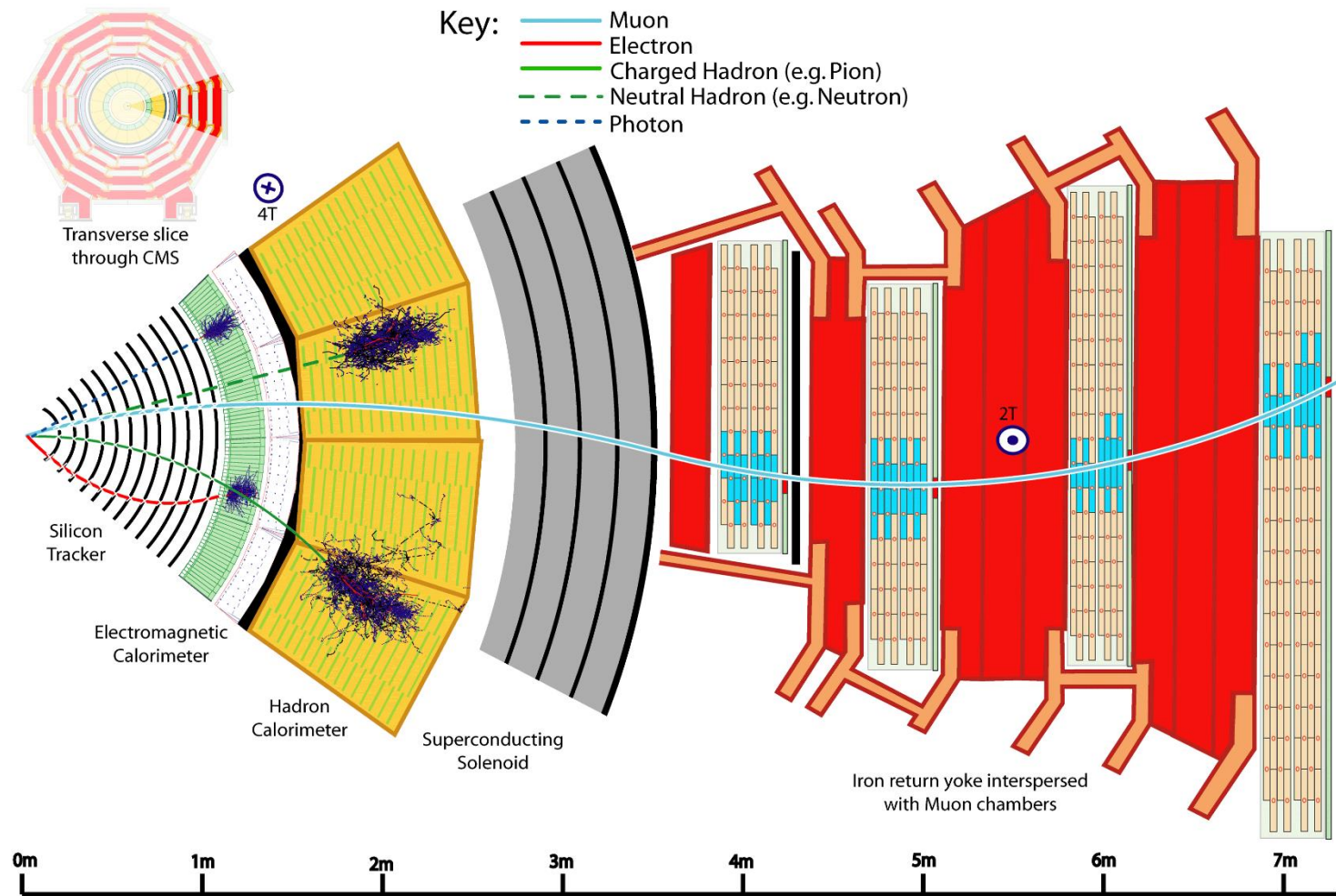



# Desirable detector properties

- High precision inner detector position information to identify secondary vertices, but amplitude information is not needed here – many layers and many channels
- Inner detector should be a light construction that does not compromise calorimeter resolution
- Good energy information in calorimeters and muon detector to determine missing momentum accurately
- All detectable particles should be detected – hermeticity
- Detector signals are often long, many bunch crossings, but must be associated with correct bunch crossing, if not, false missing momentum – **pile-up** problem at high count rates
- E/M calorimeter should be deep enough to contain electrons and  $\gamma$
- Hadron calorimeter should be deep enough to contain hadrons
- Radiation exposure determine choice of detectors and electronics



**Design compromises necessary for economical reasons**

# LHC Detectors

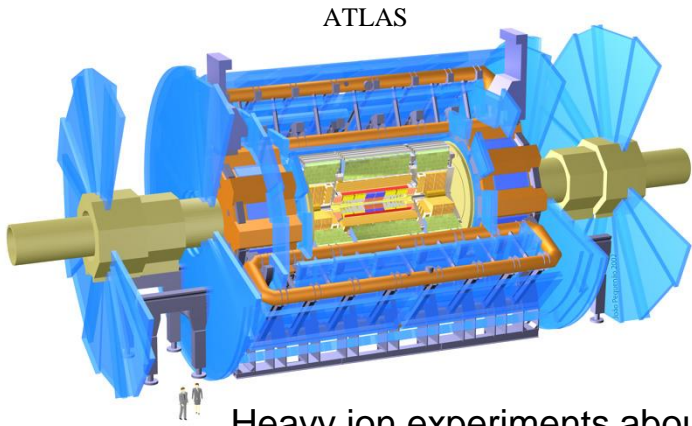

ATLAS  
Heavy ion experiments about 2 weeks/year

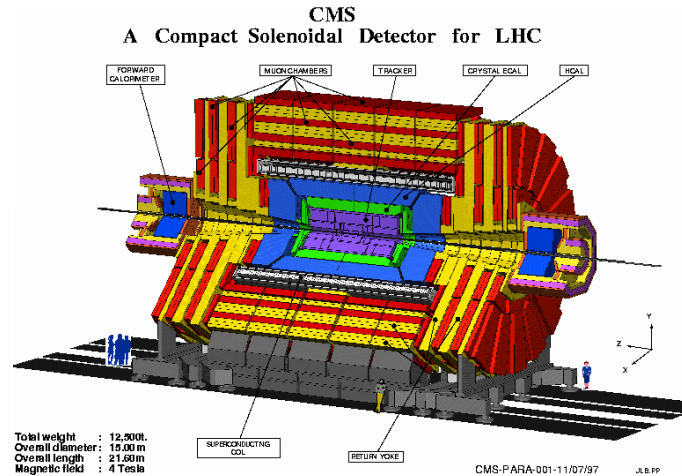

ATLAS -CMS  
Similar but different – magnet system,  
detector solutions, TDAQ system  
Competition – Collaboration

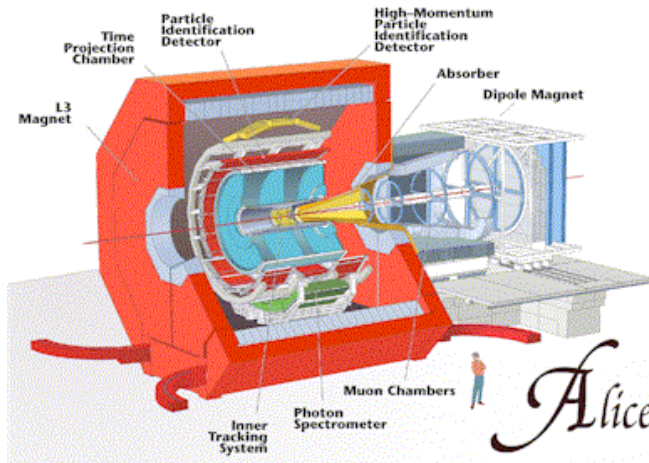

Heavy ion experiments,  
Pb – Pb or Au – Au

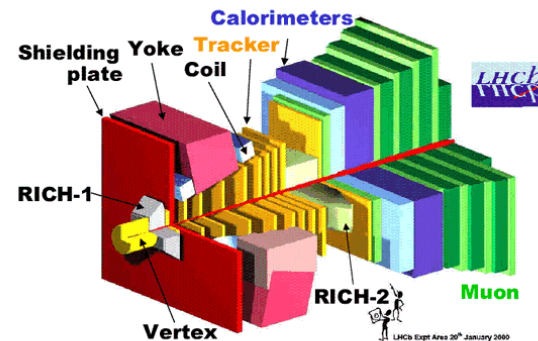

B physics at lower luminosities

Different sizes:  
ATLAS 46x25 m  
CMS 21x15 m  
Alice 26x16 m  
LHCb 21x10x13 m

# LHC results and cost

## **RESULTS so far**

Higgs particle discovered 2012 July 4th (Nobel prize 2013)

No strong indications for BSM physics (Beyond Standard Model) yet

No SUSY (SuperSymmetry) yet

## **COSTS**

LHC material costs ~3.1 G€

ATLAS material costs ~.3 G€

# A Toroidal Apparatus - ATLAS

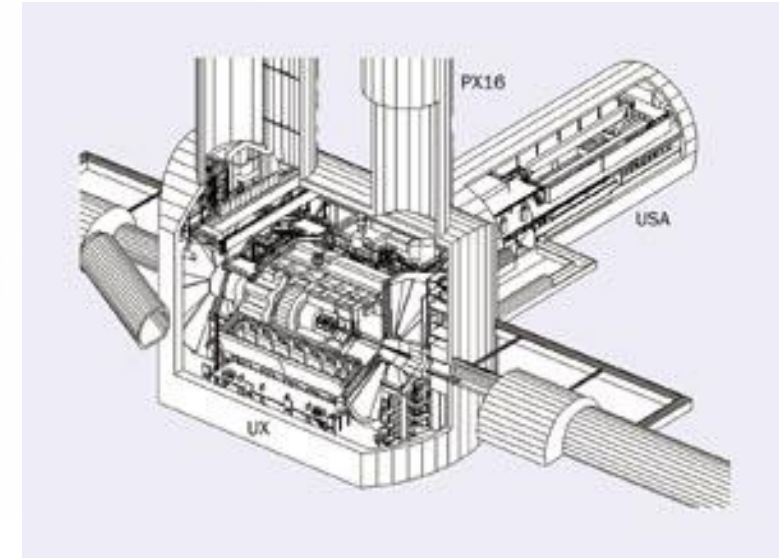
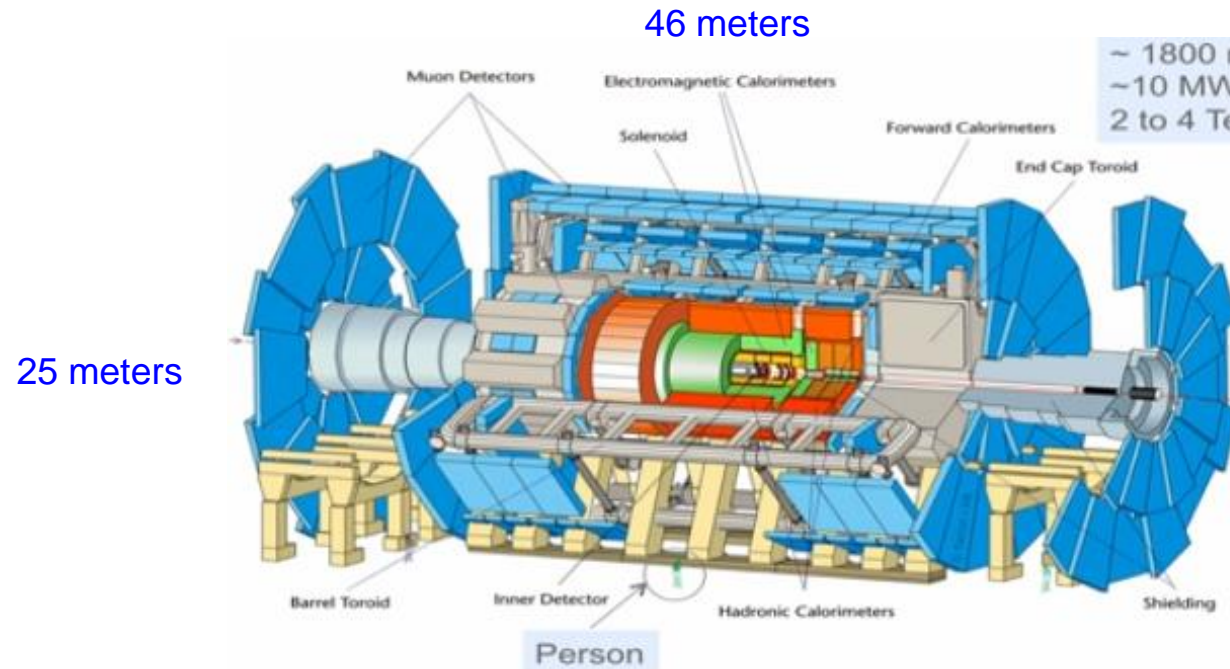

USA = Underground Storage Area  
100m below surface  
Access shafts 12 – 22 m diam.

Inner detector 1 bit? - ~86 Mch

Weight 7000 tons

E/M calorimeter 16 bit - ~300 kch

3000 physicists + x engineers

Hadron calorimeter 16 bit ~10kch

181 institutes from

Muon detector x bit ~100 kch

38 countries

# A Toroidal Apparatus - ATLAS

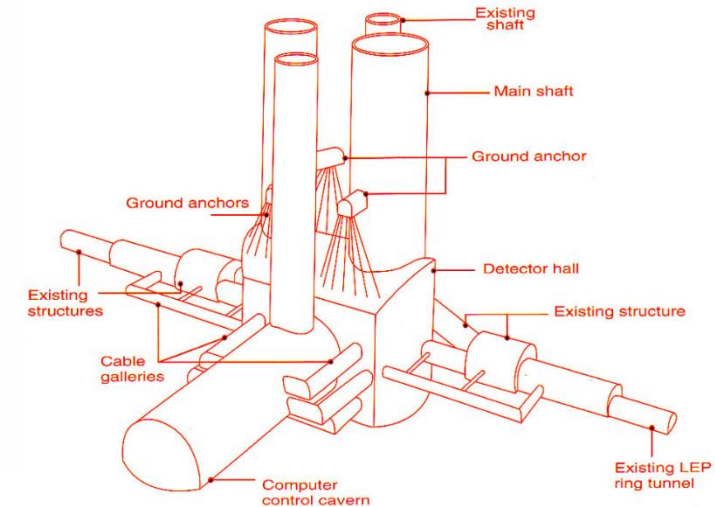
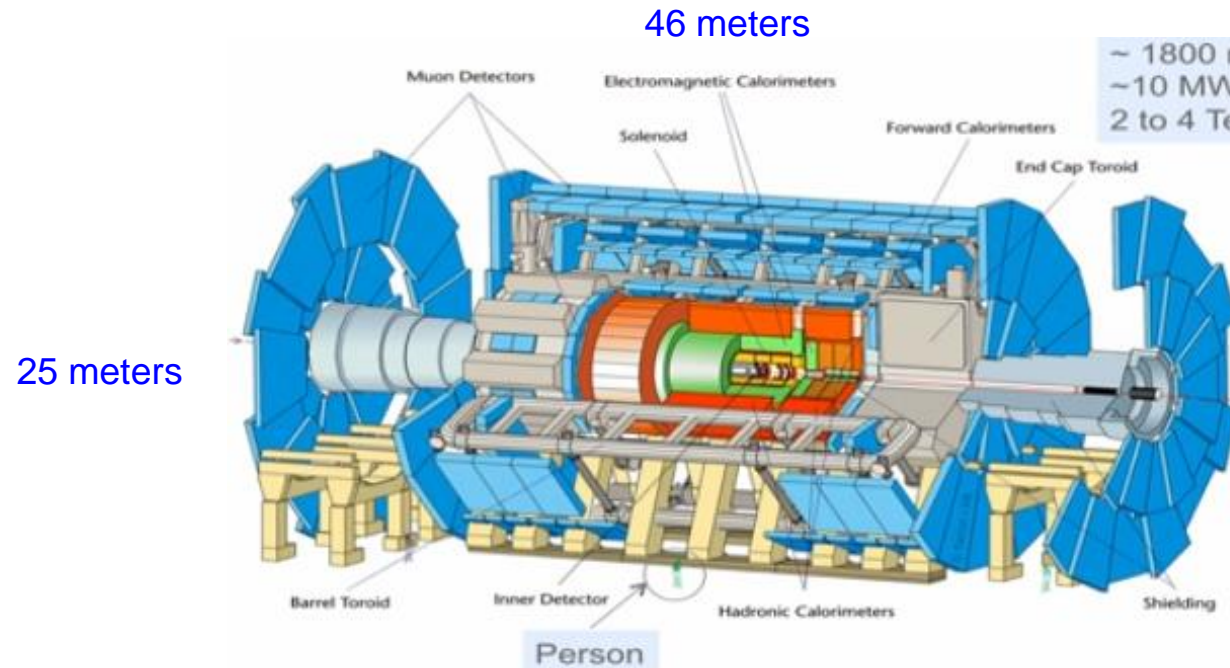

Inner detector 1 bit? - ~86 Mch  
 E/M calorimeter 16 bit - ~300 kch  
 Hadron calorimeter 16 bit ~10kch  
 Muon detector x bit ~100 kch  
 Dipole magnet 2T 2.4m diam  
 Toriod magnets  
     Barrel 4T 20.1 m diam  
     Endcap 4T 10.7 m diam

Weight 7000 tons  
 3000 physicists + x engineers  
 174 institutes from  
 38 countries

USA = Underground Storage Area  
 100m below surface  
 Access shafts 12 – 22 m diam.

# CMS – Compact Muon Solenoid

36 Nations, 159 Institutions, 1940 Scientists (February 2003)

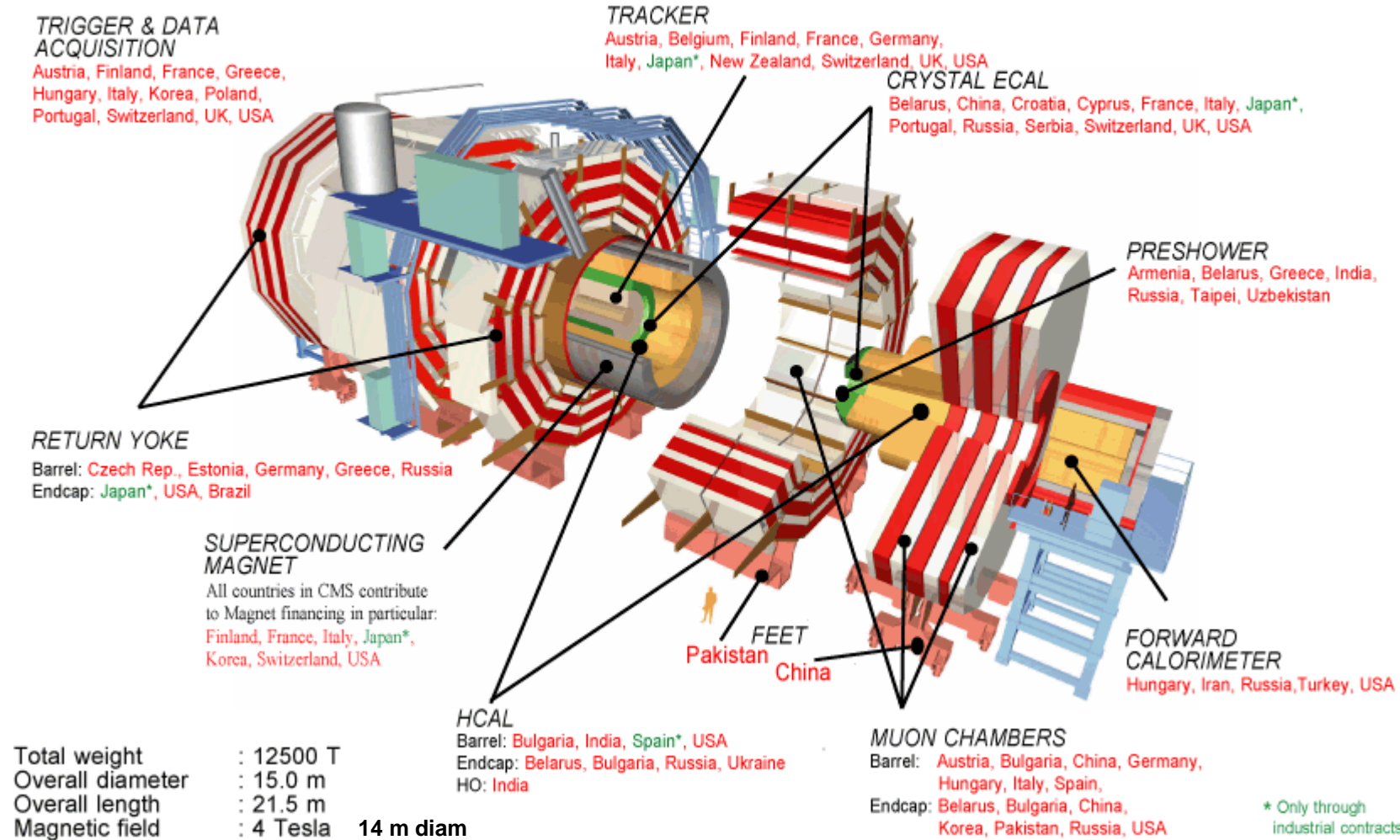

# ATLAS installation

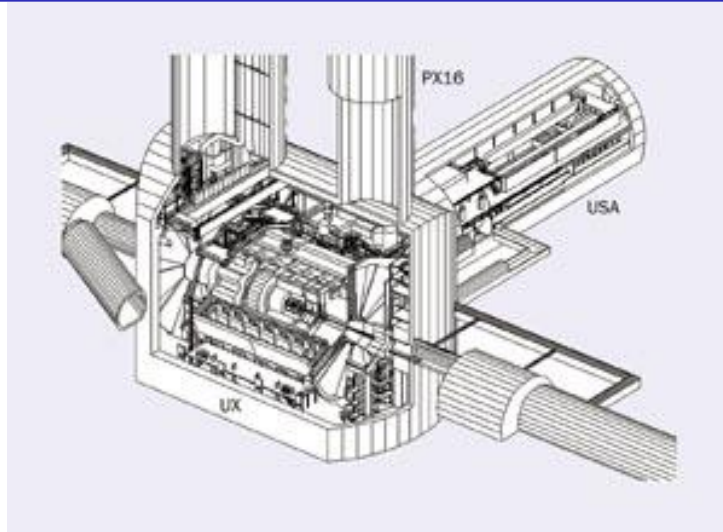

# ATLAS installation





# Radiation Detectors

A large class of radiation detectors are based on **scintillation** where the ionizing radiation excites an inorganic or organic scintillator. When the scintillator de-excites it emits light of characteristic wavelengths.

The light can be collected by **photo multipliers (PMTs), APDs or SiPMs**.

In another class of radiation detectors the radiation **ionizes the media** and an electric field separates the electrons and the ions. The media can be gaseous or liquid. Different media gives different performance.

In semiconductor detectors the radiation creates **electron-hole pairs** that are separated by the field over a p-n junction.

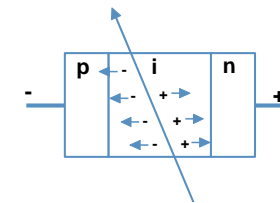
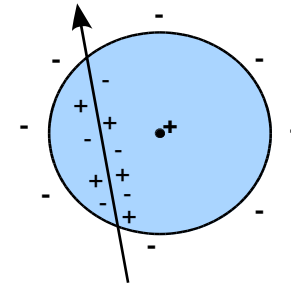
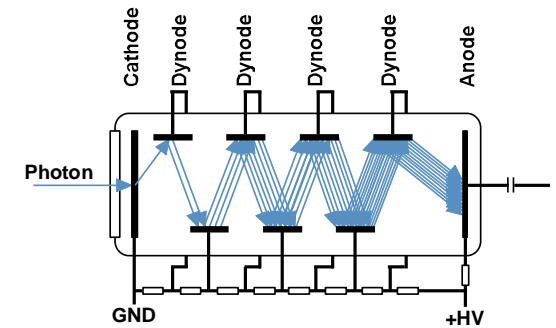
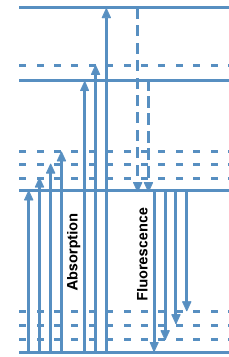

# ATLAS inner detector

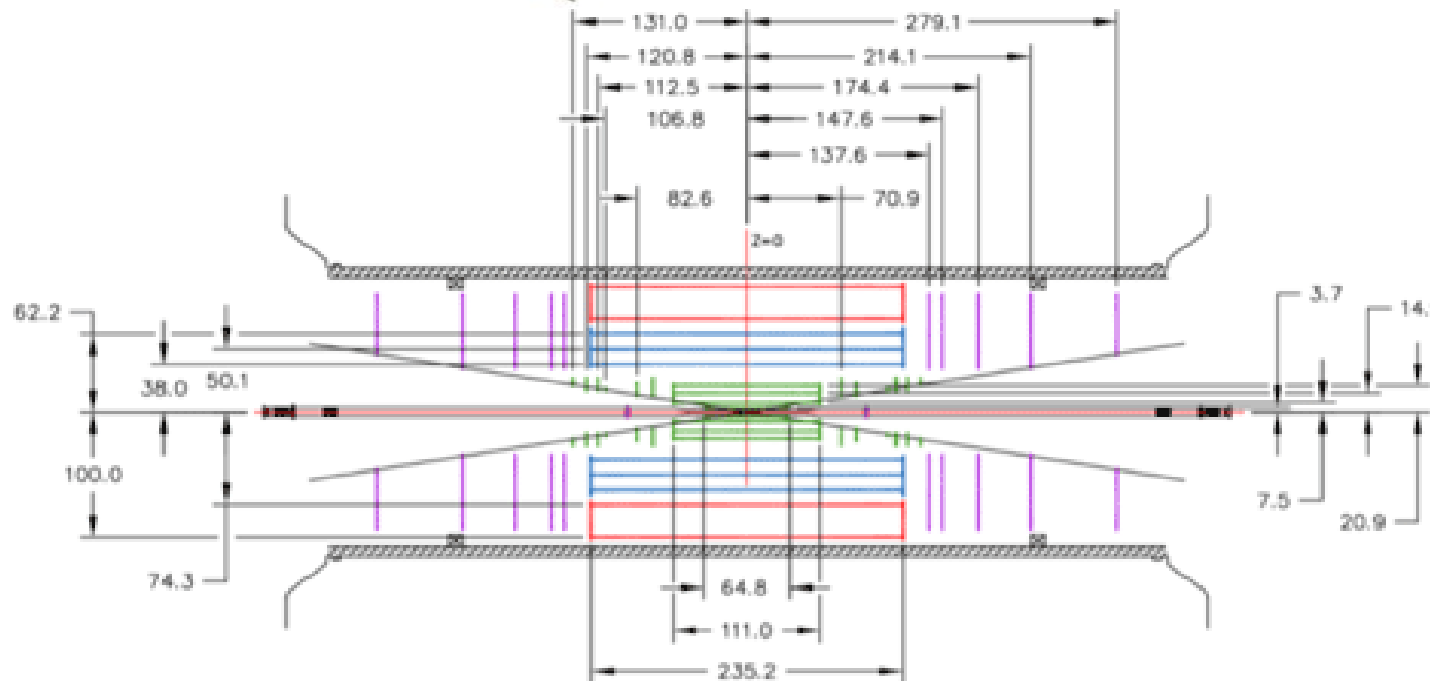
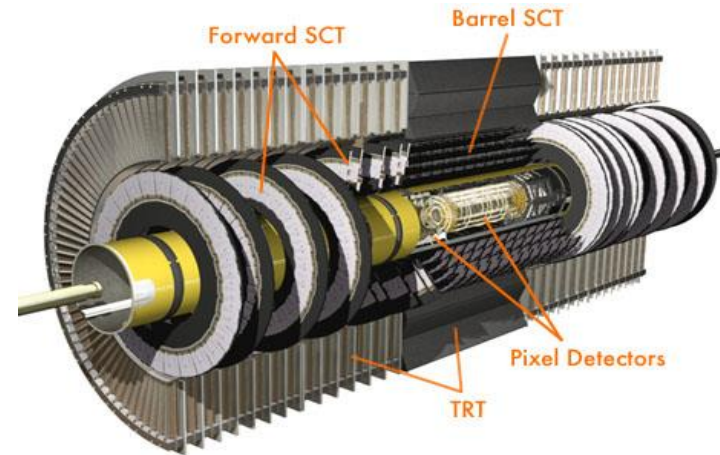
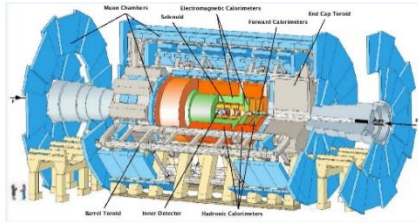

Magnetic field 2T  
3 different detector types

Pixel detector 80 Mch  
Silicon pad detector 2D resolution  $12 \mu \times 110 \mu$

Semiconductor Tracker (SCT) 6 Mch  
Silicon strip detector (1D)  
Double layers Resolution  $23 \mu \times 800 \mu$

Transition Radiation Tracker (TRT)  
300kch  
Gas detector – straw tubes  
Electron identification

# ATLAS inner detector

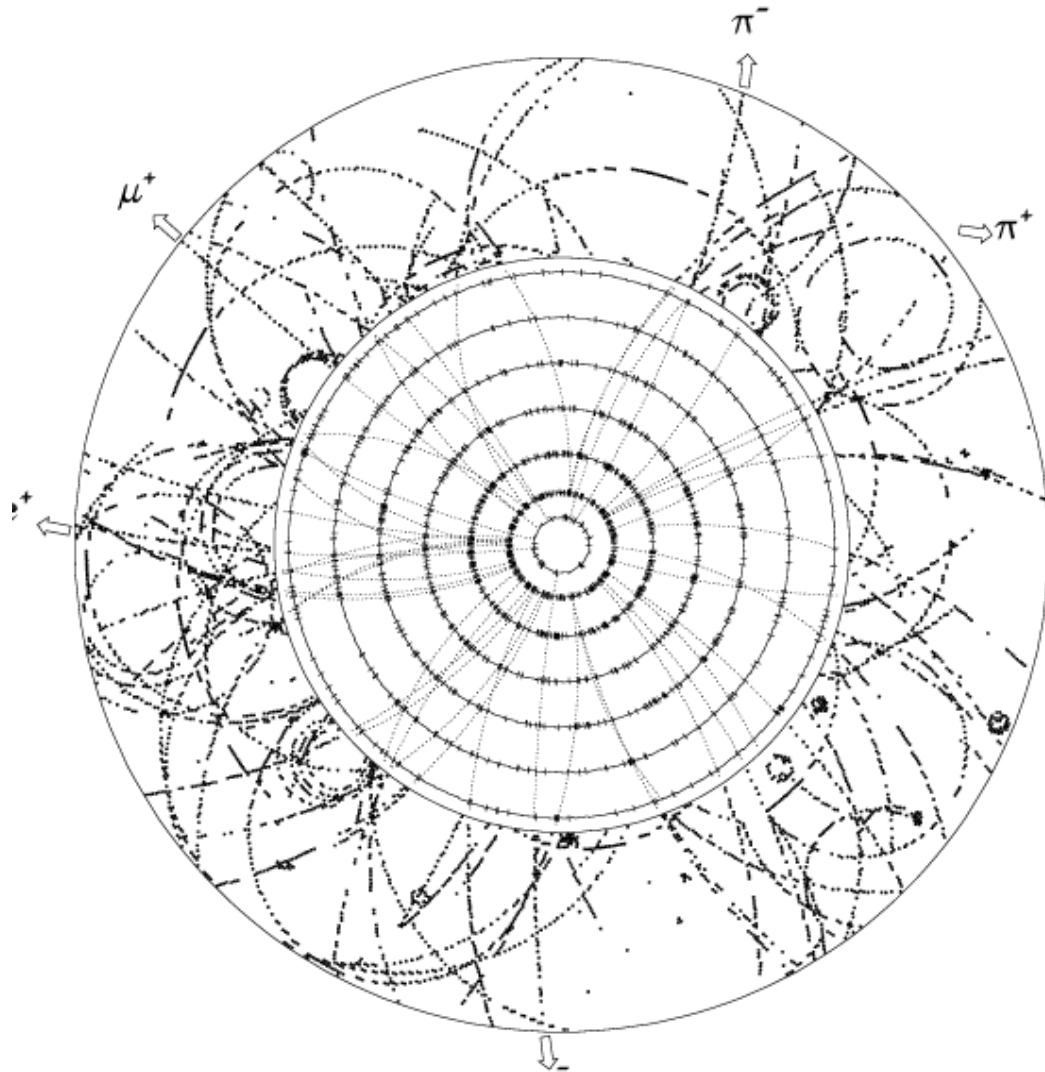

About 1000 particles

Magnetic field 2T  
3 different detector types

Pixel detector 80 Mch  
Silicon pad detector 2D resolution  $12\ \mu \times 110\ \mu$

Semiconductor Tracker (SCT) 6 Mch  
Silicon strip detector (1D)  
Double layers Resolution  $23\ \mu \times 800\ \mu$

Transition Radiation Tracker (TRT)  
300kch  
Gas detector – straw tubes  
Electron identification

Pixel detector 3 sample points  
Strip detector 4 sample points  
TRT 36 sample points

# ATLAS inner detector

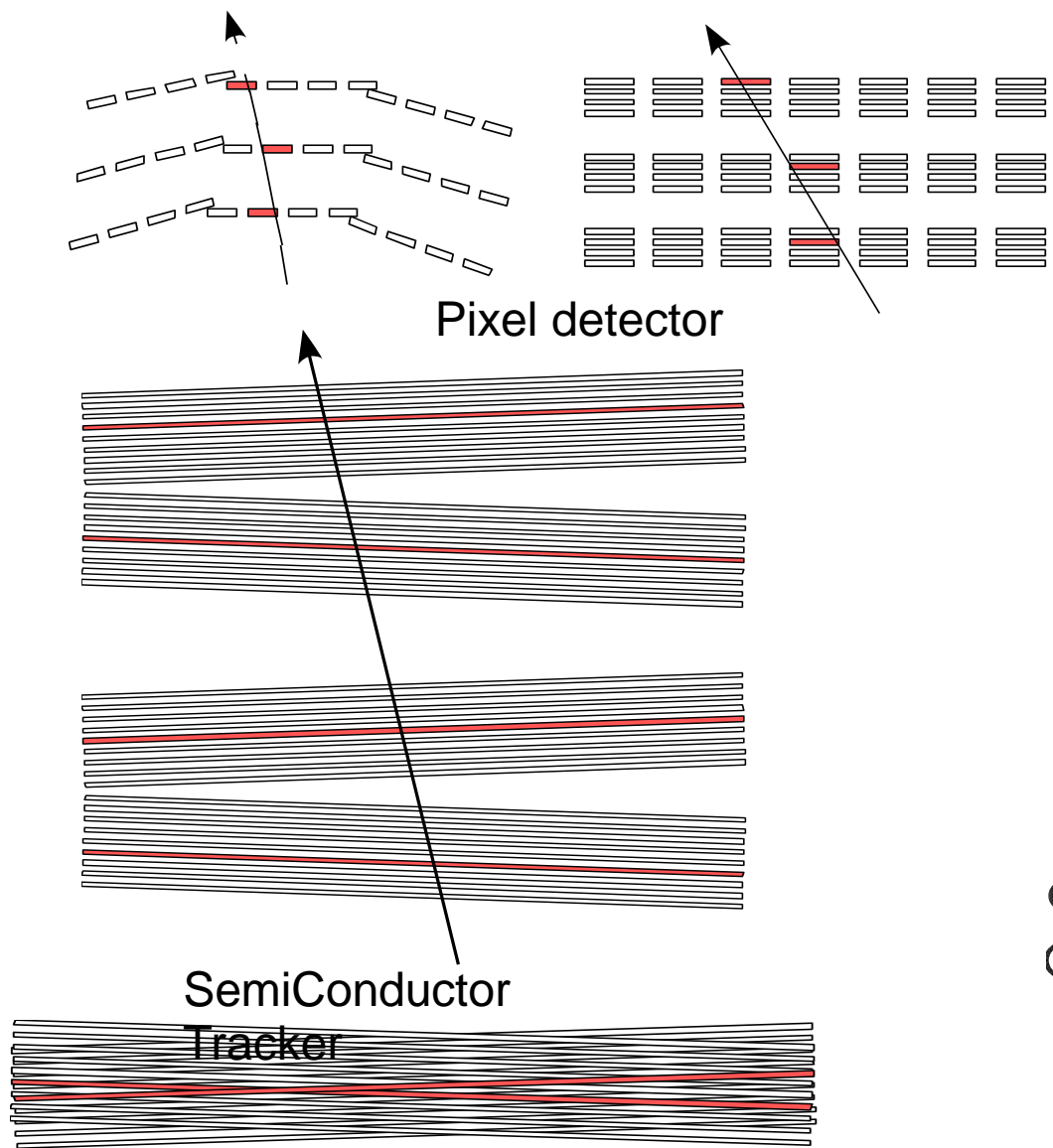

Magnetic field 2T  
3 different detector types

Pixel detector 80 Mch  
Silicon pad detector 2D resolution  $12 \mu \times 110 \mu$

Semiconductor Tracker (SCT) 6 Mch  
Silicon strip detector (1D)  
Double layers Resolution  $23 \mu \times 800 \mu$

Transition Radiation Tracker (TRT)  
300kch  
Gas detector – straw tubes  
Electron identification

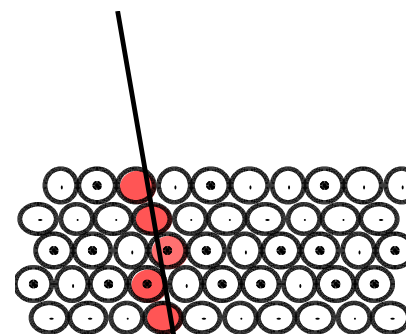

TRT

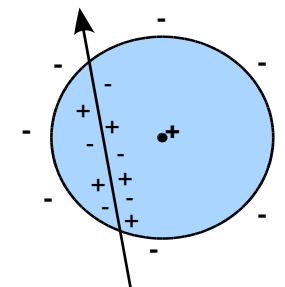

# ATLAS inner detector

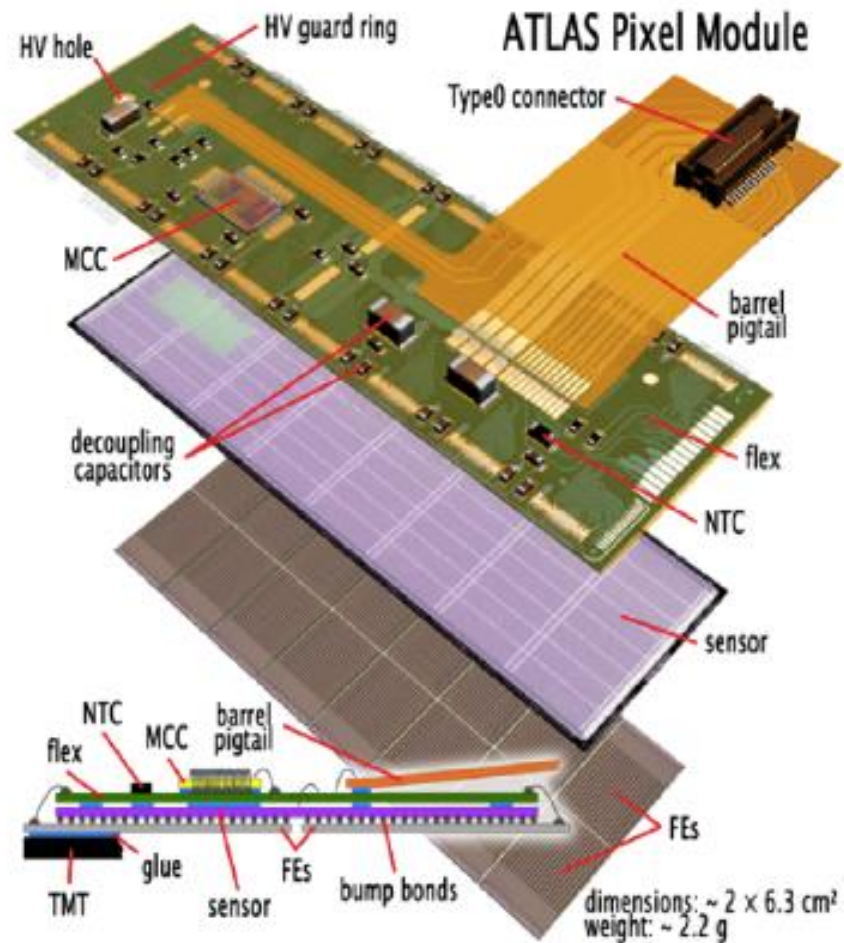

Radiation tolerance, power and cooling problematic

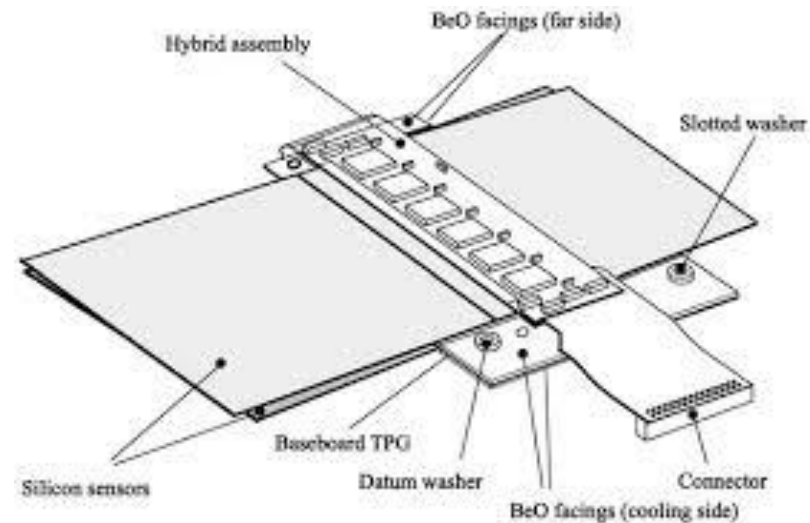

# Liquid Argon e-m calorimeter

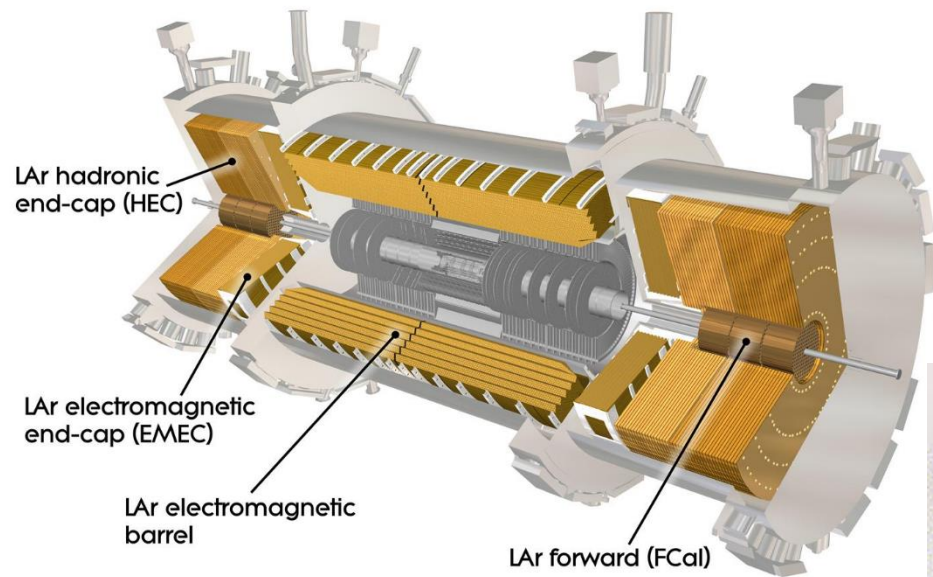

Liquid Argon-Lead/stainless steel calorimeter (87°K)

16-bit dynamic range

Cooled preamplifiers

4 layers + presampler

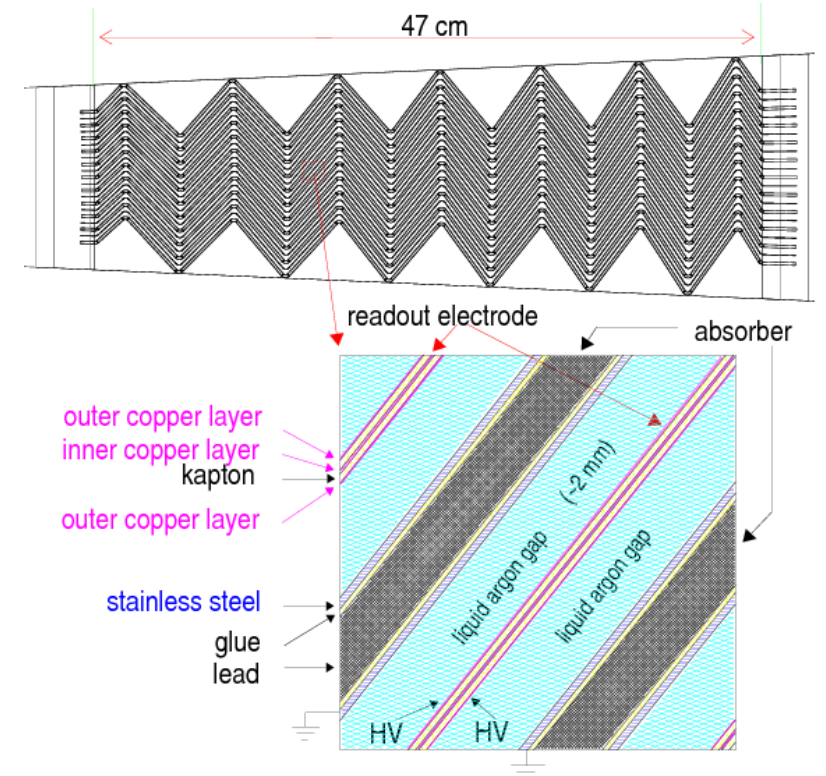
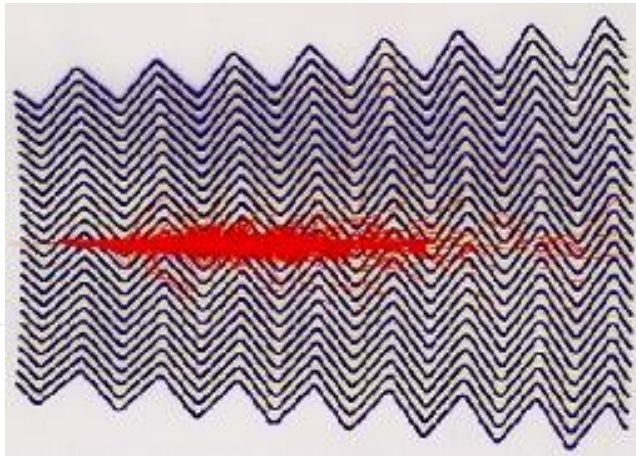
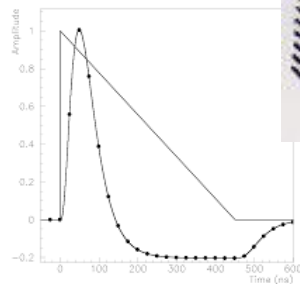

# TileCal hadron calorimeter

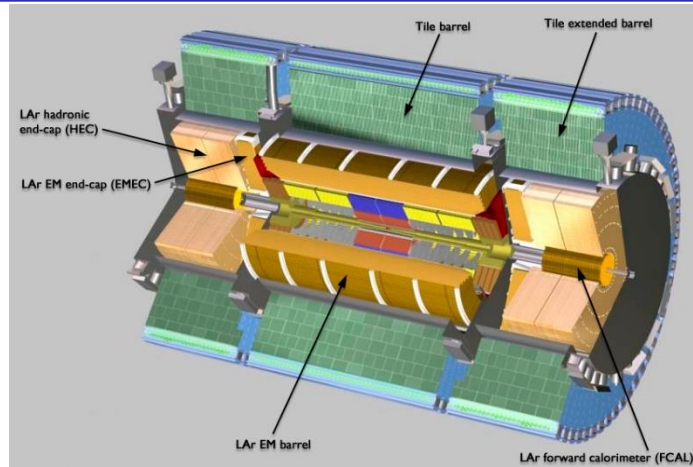

Interleaved steel and scintillator tiles

256 modules, each weighing 10 tons

4 depth layers

Coarse spatial but good amplitude resolution

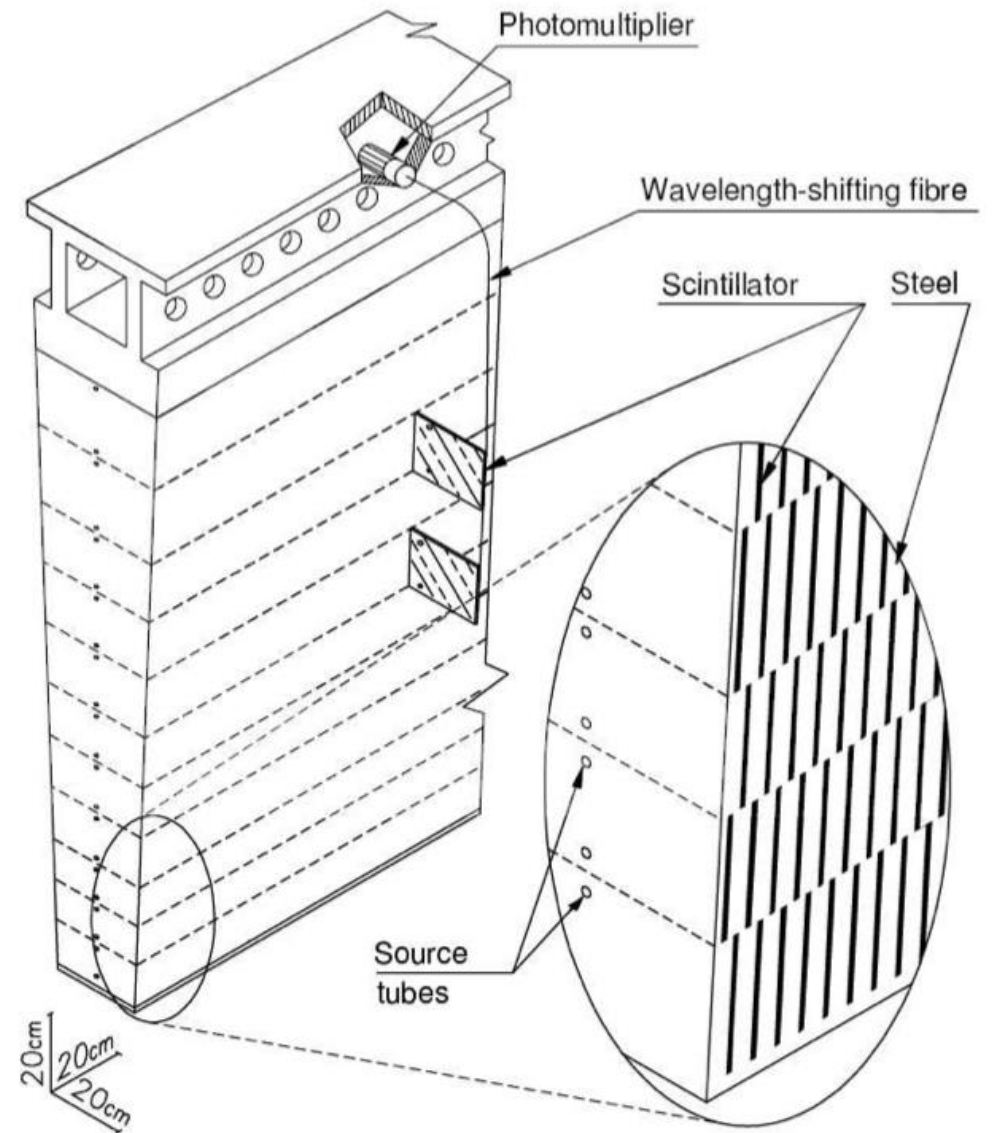
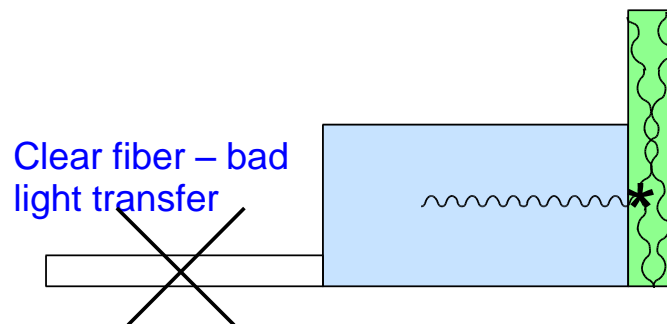

# The Muon Spectrometer

Geometrical alignment precision  $30 \mu\text{m}$

Alignment can change due to temperature change or deformations when the magnet field is changed

Cost  $\rightarrow$  Use gas detectors, different types for precision and trigger and different types for normal and high intensity regions, close to beam pipe

MDT (Monitored Drift Tubes) and CSC (Cathode Strip Chambers) for high precision. CSC for high intensity forward regions

RPC (Resistive Plate Chambers) and TGC (Thin Gap Chambers) for trigger. TGC for high intensity regions.

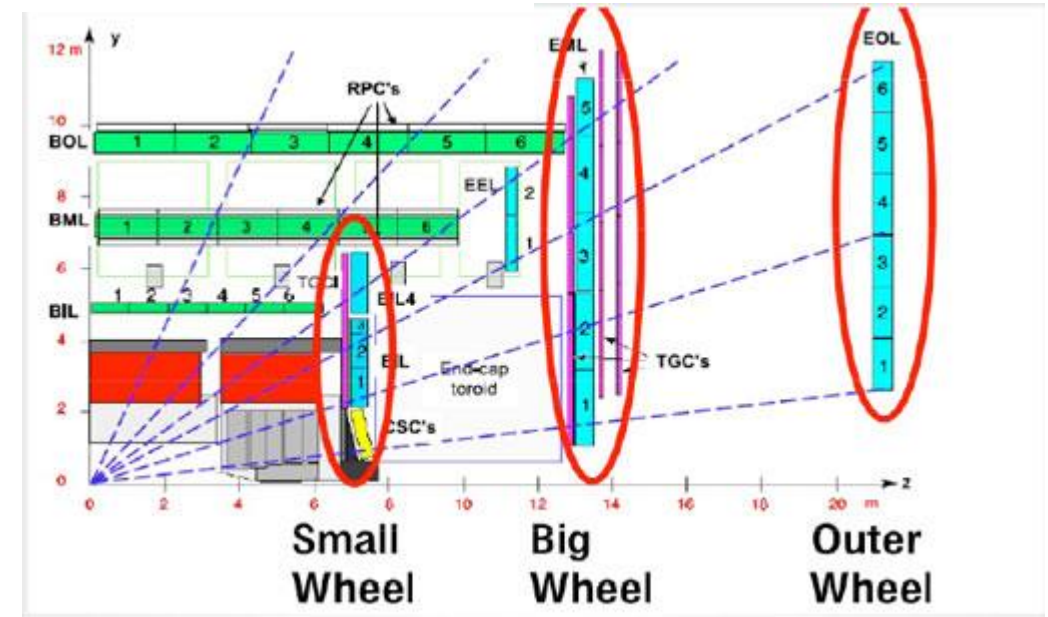
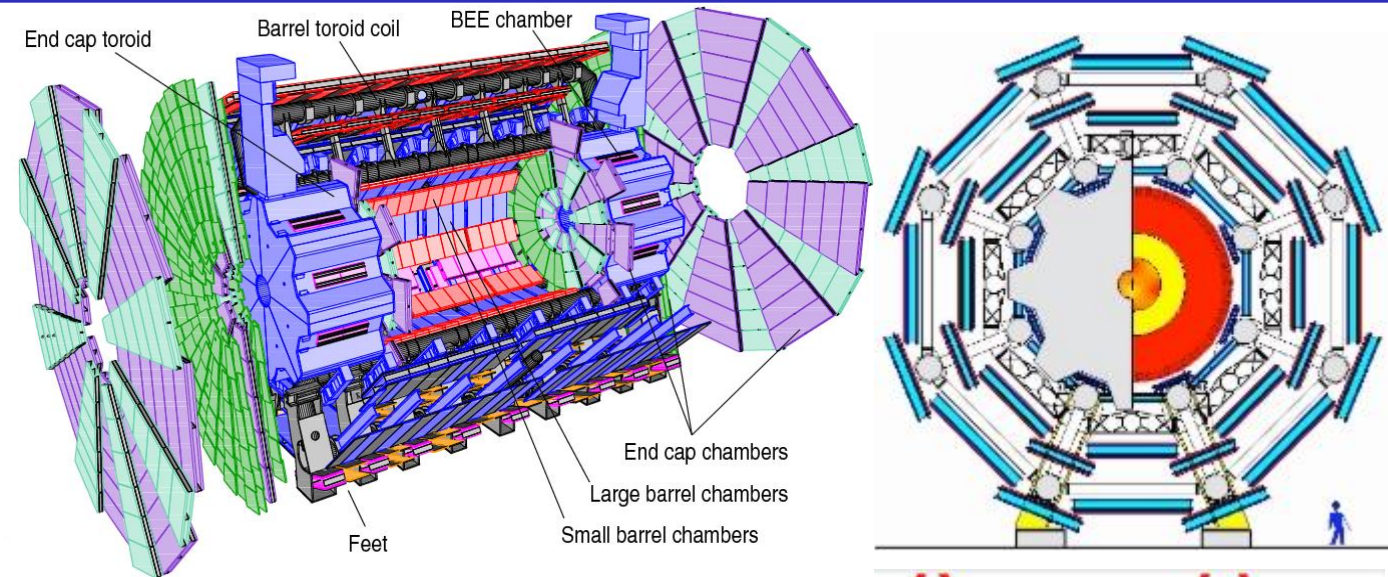



# The Muon Spectrometer

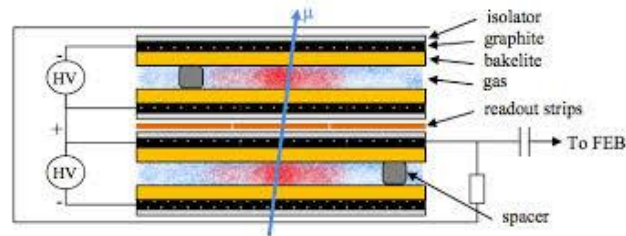

RPC – Resistive Plate Chamber

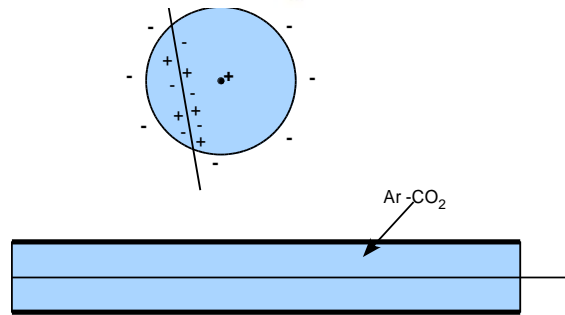

MDT – Monitored Drift Tubes

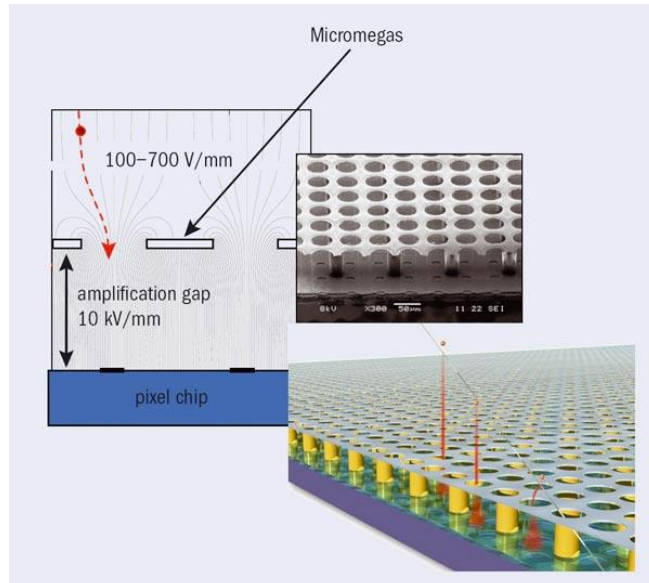

Micromegas for muon detector upgrade

# Trigger and Data Acquisition (TDAQ)

20 event per BC at nominal luminosity

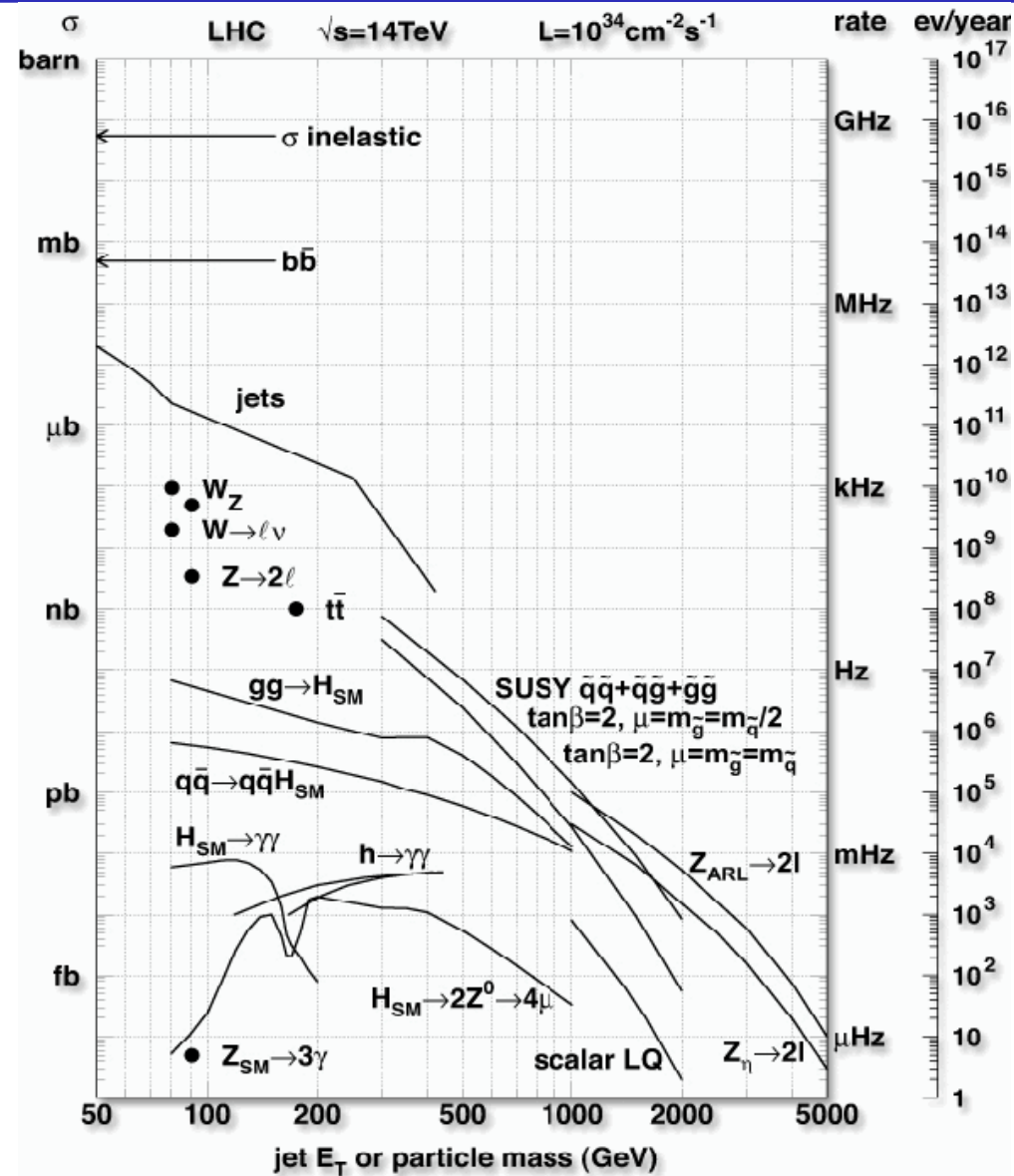

# Data from Bunch crossings present

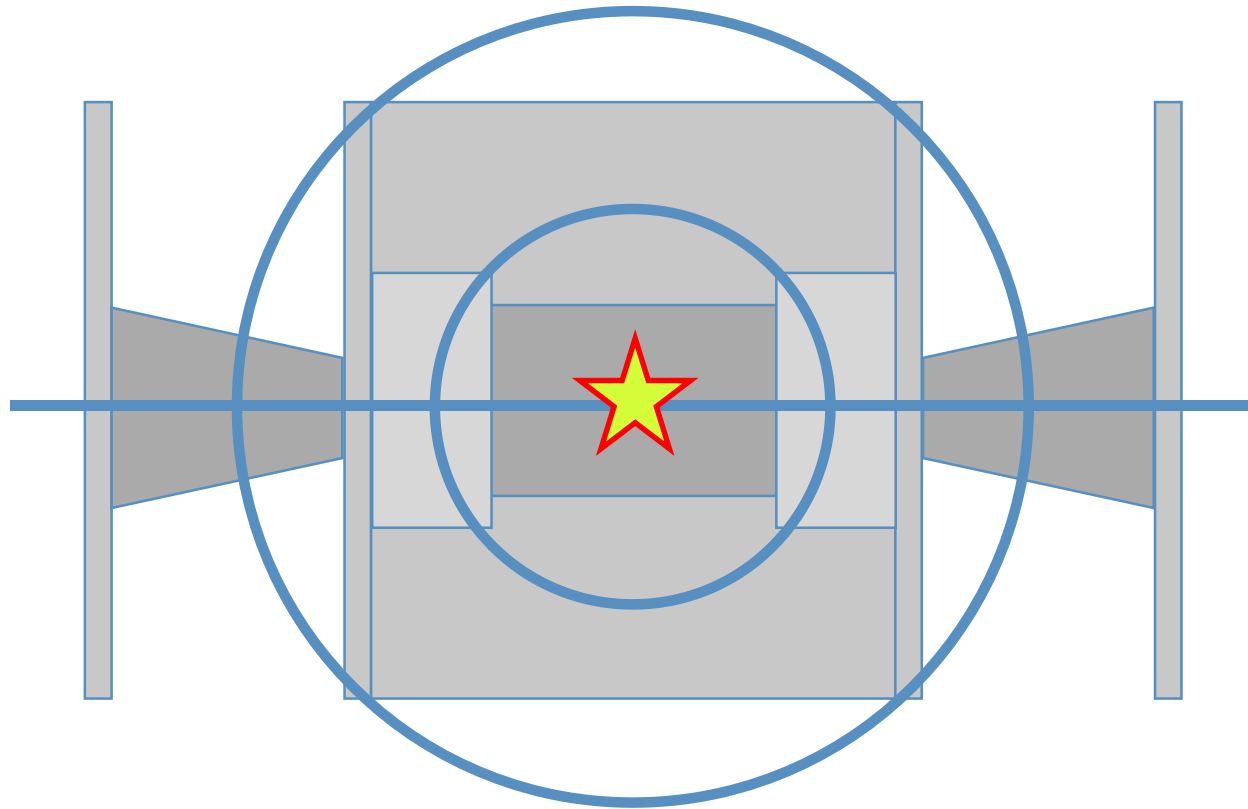

Local time reference for all detector elements so that relate to correct bunch crossing

# Trigger and Data Acquisition (TDAQ)

Reading out all data, every bunch crossing, completely impossible 2008 - data transfer limitations  
Solution -> use multilevel trigger – data storage limitations, radiation tolerance

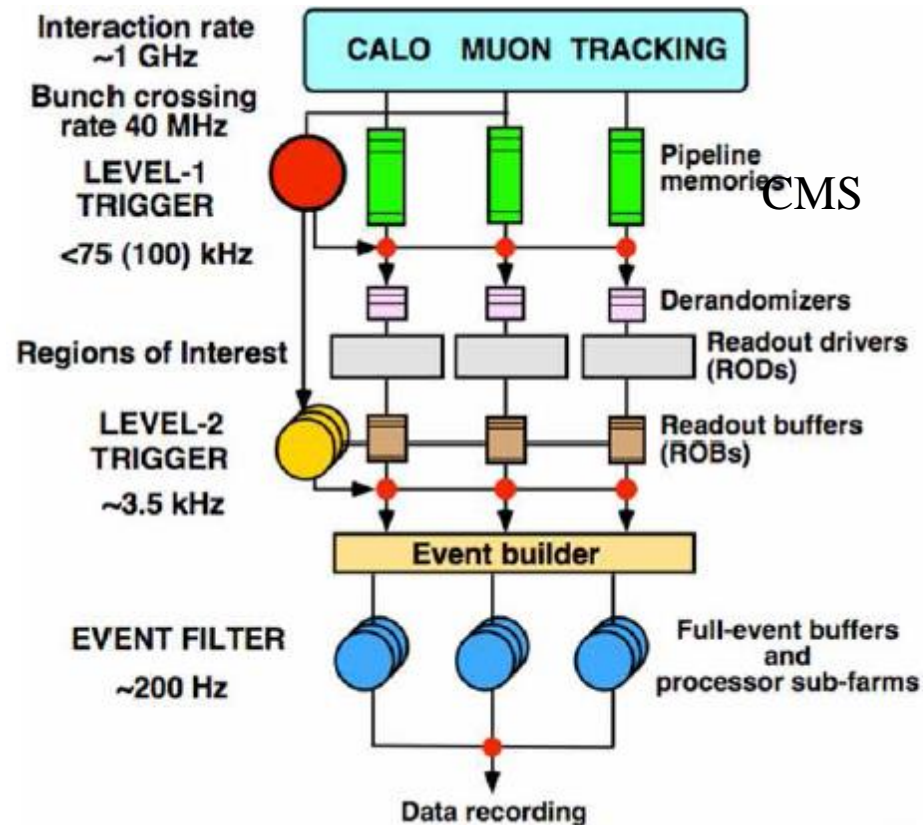

# Trigger and Data Acquisition (TDAQ)

First level trigger – pipe-lined processing (in FPGAs) of merged calorimeter and muon data with reduced spatial and amplitude information - delivers Regions Of Interest

Second level trigger – PC based software processing full resolution data from all subdetectors but only from RIOs

Third level trigger – Event Builder – PC farm to on-line analyze all data at highest precision

A first selection criteria is to require large transverse energy components to guarantee a head-on collision

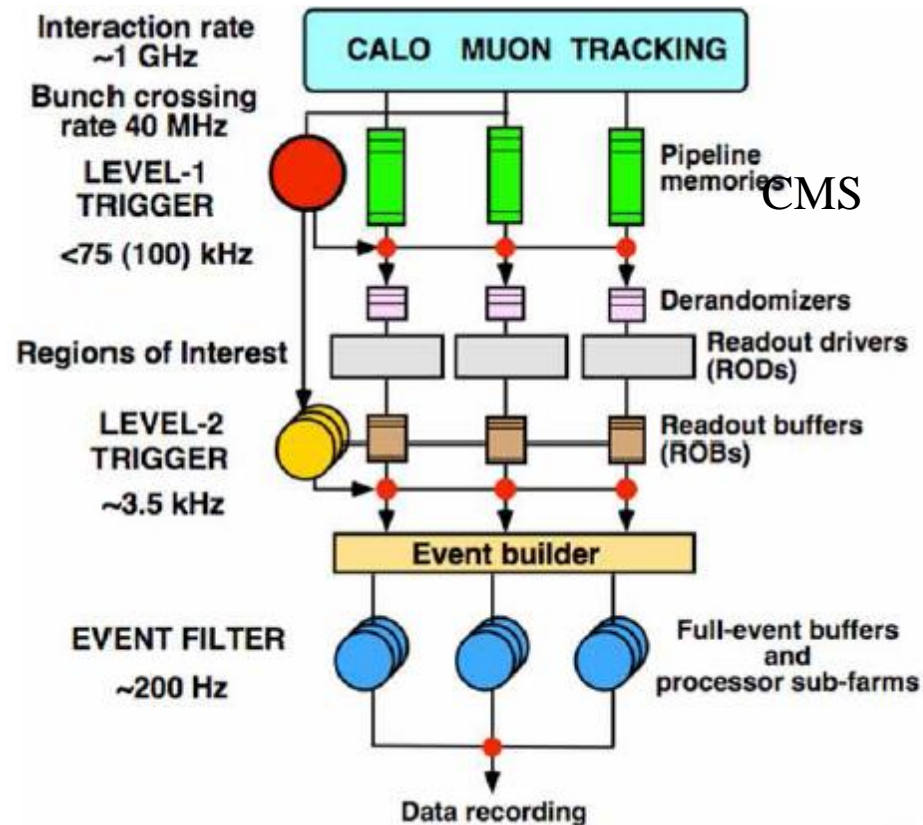

# First level trigger

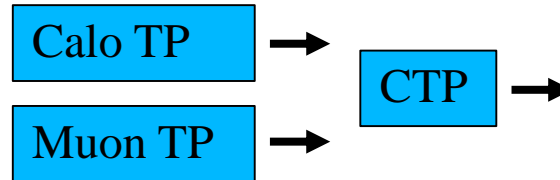

The Calorimeter trigger processor and the Muon trigger processor reports to the **Central Trigger Processor (CTP)**

CTP looks for characteristic signatures in the data that indicates that the data contains an interesting event e.g.

- 4 isolated electrons or
- 4 muons or
- 2 high energy electrons over a certain threshold and 2 jets
- etc.

The search criteria are defined in the **Trigger Menu** data base

The current Trigger Menu selection is defined at the start of a run

# First level trigger

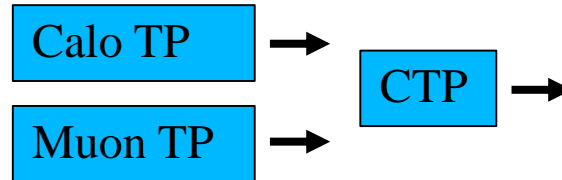

All data can be stored on the detector for maximum  $2.5 \mu\text{s}$  – the **latency** of the first level trigger

Before this, a decision must be made on saving or not saving that data

The specified data latency allows for sending the data from the detector to the trigger processor in USA-15 (Underground Storage Area), process it and send the result back to the detector for possible transmission of the entire data set.

# First level trigger

Each bunch crossing, i.e. each 25ns

4096 trigger data values arrive from LAr and Tile

64 cell rows around the calorimeter cylinder and 64 cells in each row along the detector

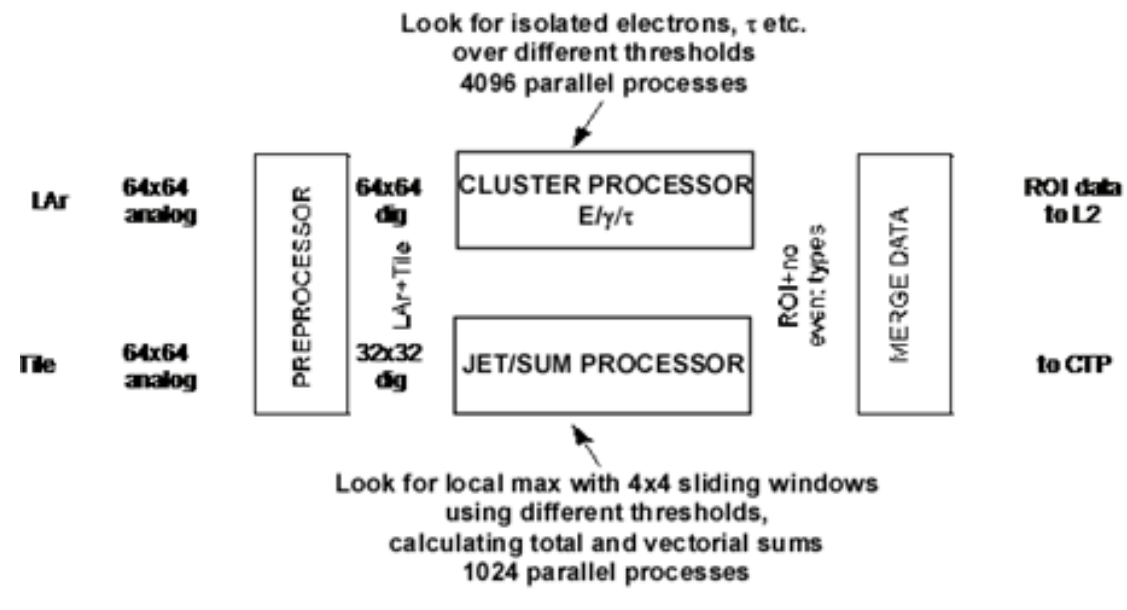
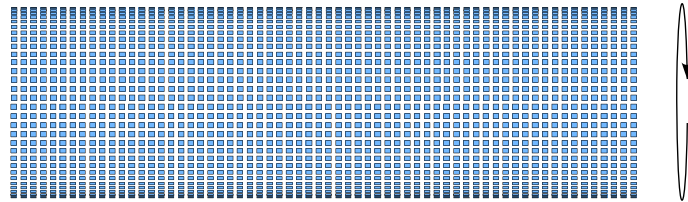

For each corresponding trigger cell one must study if it contained an interesting event  
4096 parallel processes start every 25ns and should be completed within 1  $\mu$ s  
FPGAs widely used together with pipelined processing



# First level trigger

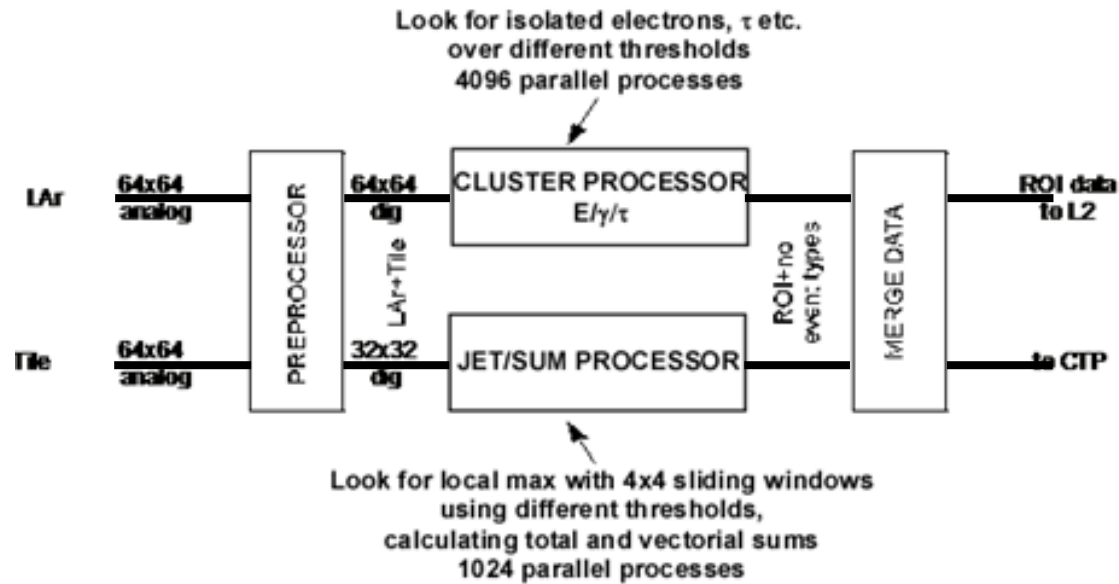

## CLUSTER FINDING $e/\gamma$ ALGORITHM

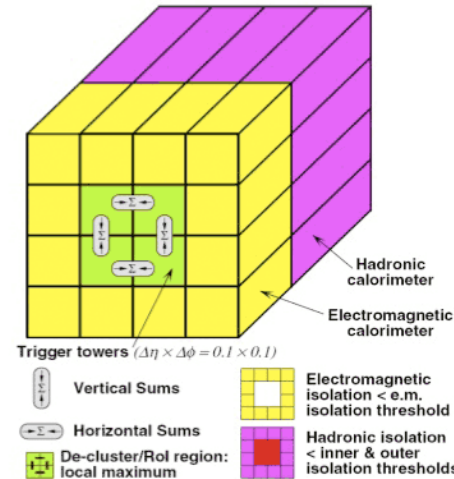

- For each cell and each set of thresh.
- Vert. SUM or Hor. SUM > thresh.
- Em isolation SUM < thresh.
- Had isolation SUM < thresh.

## JET MAX ALGORITHM

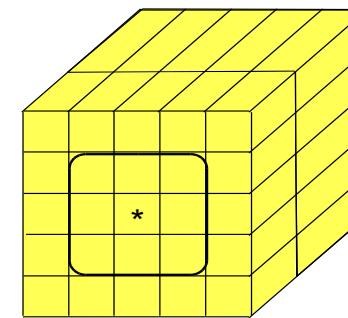

$E_0$



$E_{NW}$



$E_{SW}$



$E_{SE}$



$E_{NE}$

# Synchronization

The Timing, Trigger and Control (TTC) system is responsible for synchronization

The accelerator clock 40.08 MHz distributed to all Front-End units with local phase control

L1A distributed to all FE-boards with programmable delay to maintain sync.

Addressed commands to configure local FE-boards

Maintains Bunch Crossing Identifier BCID to label events

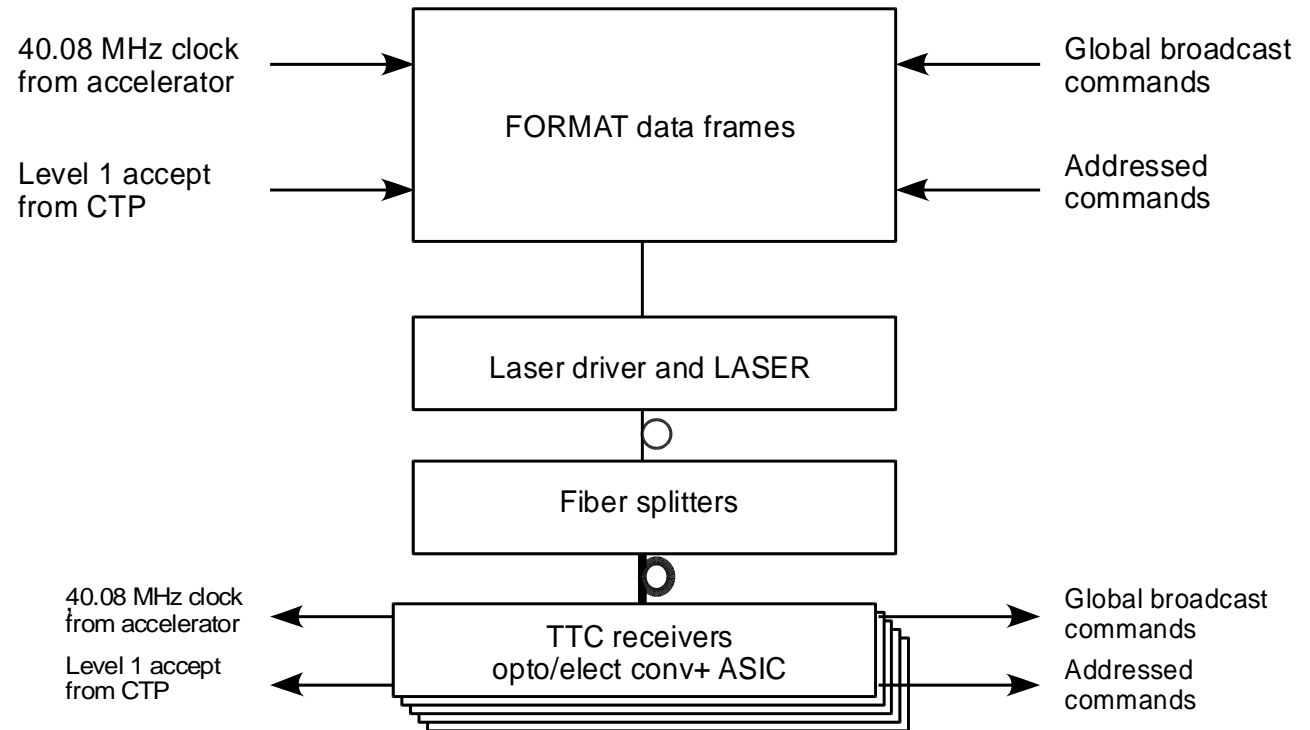

# Detector Control - DCS

The Detector Control System or Slow Control, as it was called before, is responsible for initializing and monitoring of all system components including configuring programmable logic (FPGAs).

It will monitor parameters like temperatures, fan operation, pressures, voltages, currents, humidities, error conditions etc..

It is also responsible for safety functions and alarms

It records error conditions and archives monitored parameters

When supervising DCS it is important to have efficient and intuitive GUIs

## ATLAS control room

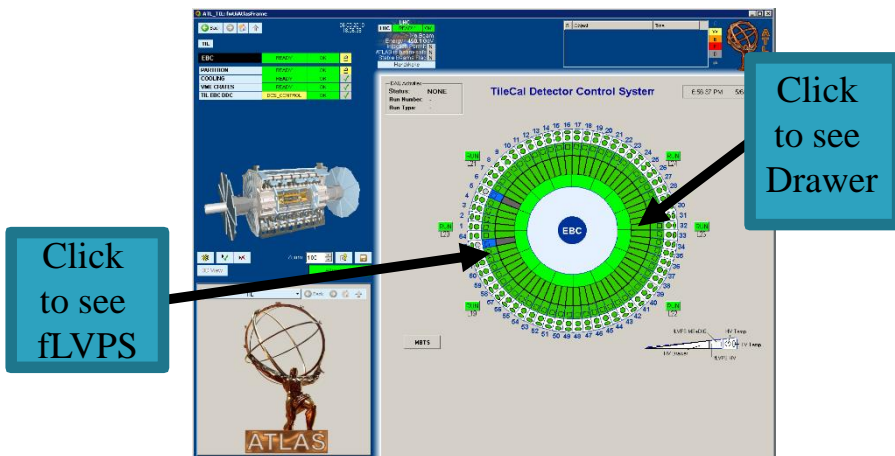

# ATLAS upgrades

LHC has yearly stops for minor repairs (end of year)  
and regular stops for longer maintenance and upgrade, LS 1-

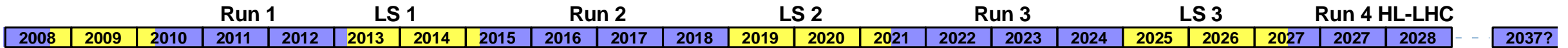

End of operation 2037?

**Initial operation - Run 1**  
Reduced energy 6.5 TeV  
Luminosity:

# ATLAS upgrades

LHC has yearly stops for minor repairs (end of year)  
and regular stops for longer maintenance and upgrade, LS 1-

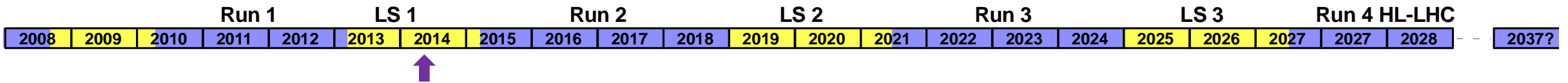

End of operation 2037?

## Upgrade phase 0 (LS1)

Prepare for almost full energy 13 TeV

Insertable B-layer (3.3 cm from beam center) – replaced the inner pixel layer

# ATLAS upgrades

LHC has yearly stops for minor repairs (end of year)  
and regular stops for longer maintenance and upgrade, LS 1-

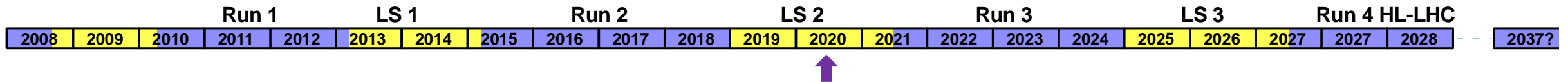

End of operation 2037?

## Upgrade phase 1 (LS 2) – 2019-2020

3 times higher luminosity, need better algorithms

Full energy 14 TeV

New Small Wheel? (at least one)

Topological trigger – not only count event but also consider their geometrical relationship

LAr fully digital trigger

New trigger architecture

# ATLAS upgrades

LHC has yearly stops for minor repairs (end of year)  
and regular stops for longer maintenance and upgrade, LS 1-

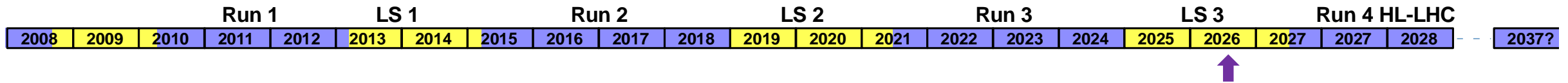

End of operation 2037?

## Upgrade phase 2 (LS 3) – 2025-27

### Prepare for HL-LHC (High Luminosity LHC)

5 times nominal instantaneous luminosity, need still better algorithms

10 times total luminosity – luminosity leveling

New Trigger system – level 0 (L0a: 1MHz, Latency: 6 $\mu$ s) (level 1

(L1a:<400kHz, Latency: <30 $\mu$ s))?

New inner detector – no TRT, track trigger (introducing track data into Level 1)?

New TileCal electronics – read out all data to USA-15 – fully digital trigger

New trigger architecture L0/L1?, higher rates, longer latencies

Track trigger?

# Different electronic design strategies

When designing the first (present) version of the ATLAS electronics then:

- Special rad hard (tolerant) electronics was available (close to end of cold war)

- High speed data transmission (optical or electrical) expensive →

Send reduced trigger data to external L1 trigger processor. Keep data on detector until L1 accepted – reduced data flow

Now:

- standard electronics reasonably radiation tolerant – SEE problem

- High speed transmission available →

Remove all data from detector as soon as possible

Then:

- FPGAs unsafe

Now:

- SEE mitigation techniques exist making on-detector FPGAs feasible



# Mistakes

**We learn from mistakes but some times we forget what we learned'**

**Connector problems**

**Power supply problems**

**Radiation sensitivity problems**

**Problems with new untested techniques**

# Future

## General trends

Higher energies

Higher luminosity

Higher granularity in all detector sub-systems

More complicated events to process early in the triggers

More on-detector FPGAs – new FPGAs more radiation tolerant to hard but not soft errors – develop correction strategies for soft errors

More high speed data transmission – 40 Gb/s or more

Early digitization – less analog, more digital

After 2037: ILC? CLIC? FCC



Future Circular Collider

FCC

50+50TeV

First  $e^+ - e^-$  later  $p - p$

100 km circumference

Assumes new magnet technologies

(20 TeV magnets)

Kick off for Conceptual Design Report Nov 9

**BUT THIS IS FOR YOU!**

# Backup slides

# Calorimeters

Two main types of calorimeters

Homogeneous

Crystal or liquid

Sampling

Interleaved absorbers and scintillators

High Z values good for EM, U and W have been used

CMS ECAL is homogeneous and CMS HCAL of sampling type

ATLAS Lar and TileCal are both of sampling type

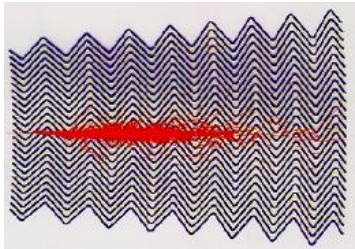

Lar: Ar (liq)+Pb

To understand the calorimeter response require multiple test beam tests

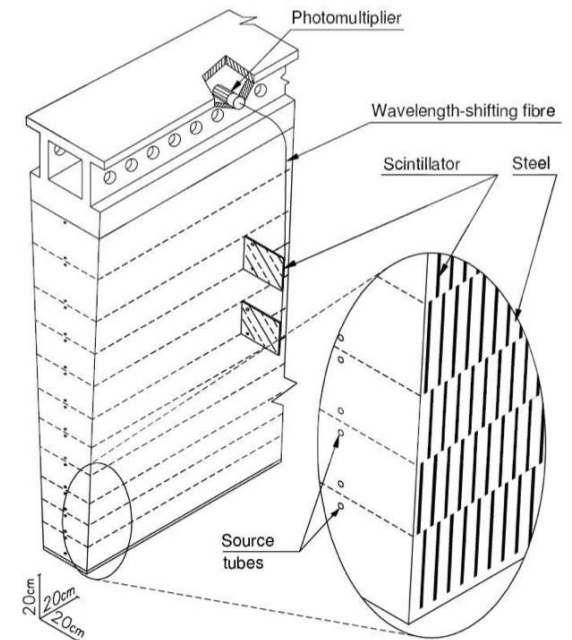
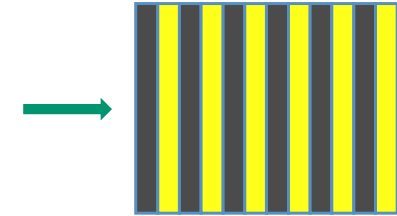

TileCal: Steel+plastic scintillator

# Calibration - problem for TileCal

Scintillators and fibers age due to radiation

PMTs age when exposed to light

Three calibration methods:

- Cesium calibration – with circulating sources
- Laser calibration – with clear fibers
- Charge injection – in FEB

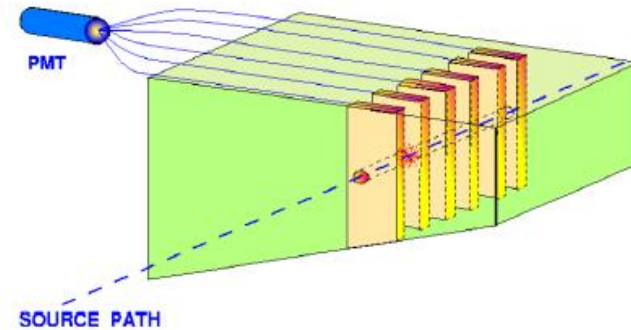

Performed often sometimes in gaps during measurements

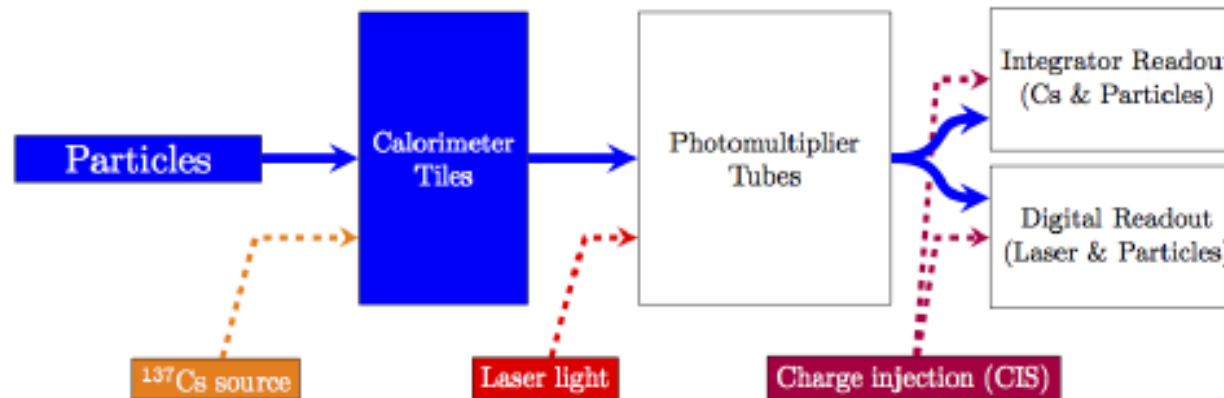

Ref:  
Richard Wigmans

# TDAQ

## Trigger and Data Acquisition

TDAQ tasks:

- Read out data from the detectors (**Readout**)

- Collect complete events (**Event Building**)

- Keep some typical uninteresting events for further analysis

- Stores event data (**Data logging**)

- Provides control, configuration and monitoring facilities (**Detector Control System, DCS**)

# Pipelined Processing

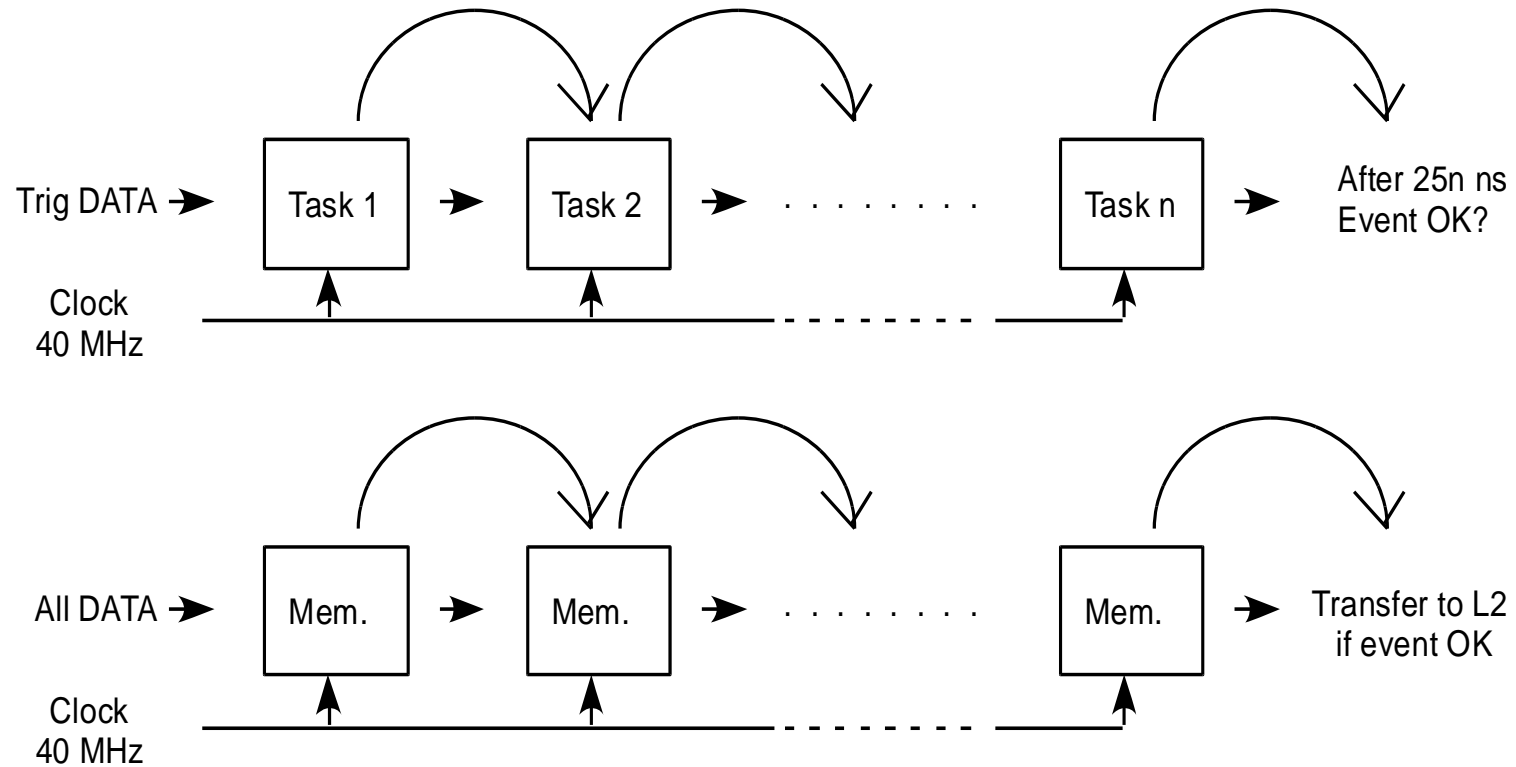

# On/off-detector Processing

In the original ATLAS electronics high band width communication was expensive -> Send reduced (amplitude and granularity data) trigger data to off detector LEVEL 1 Trigger processor. The decision is sent back to the detector.

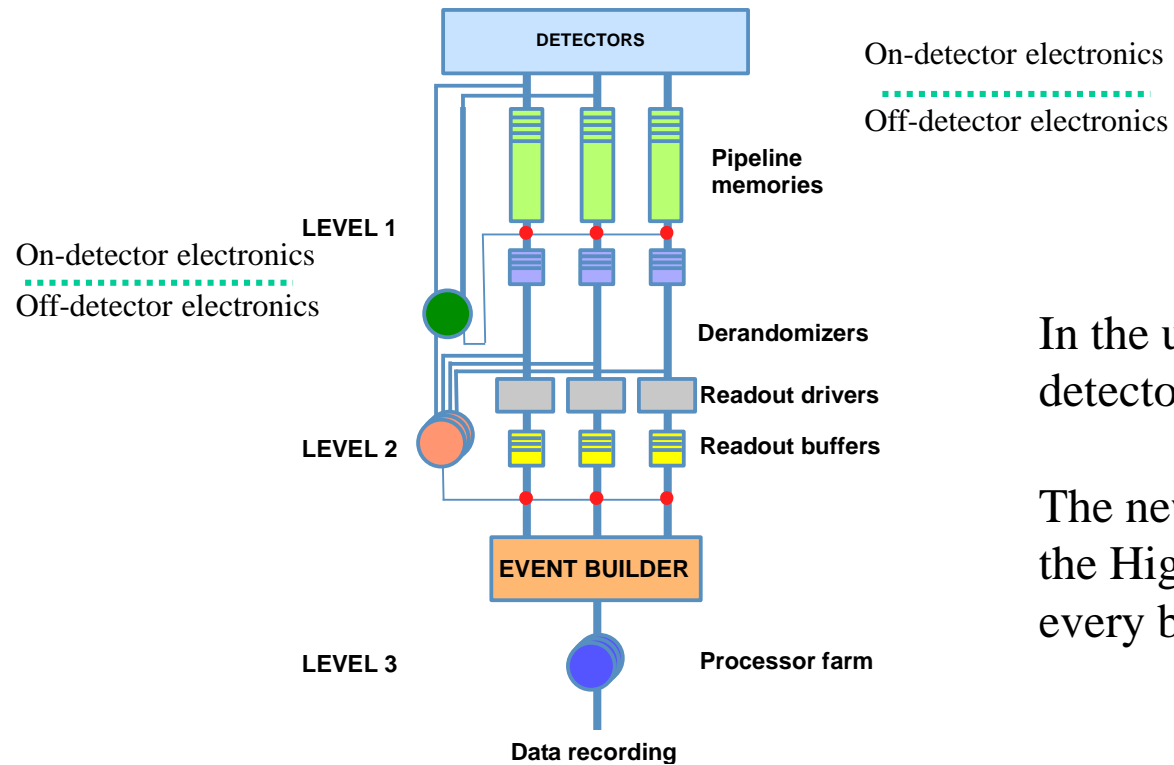

In the upgraded system digitized data is sent off detector without delay.

The new strategy is necessary to cope with the needs of the High-luminosity LHC and its 200 collision event at every bunch crossing.



# Optical communication

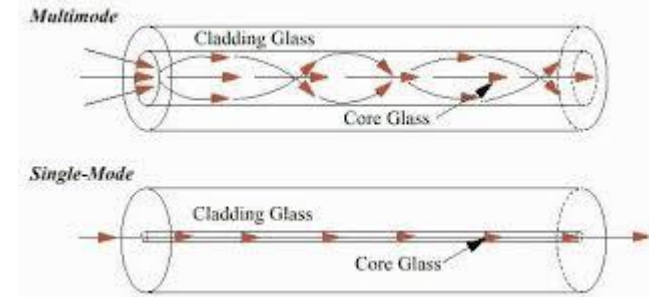

Optical communication has become much cheaper. Fiber links carrying 10 Gbps is practical over 100 m distances.

2 alternatives:

Single mode fibers -> Cheap fibers, more expensive optical transmitter and receivers.  
Low signal losses

Multimode fibers -> More expensive fibers, less expensive transmitter and receivers.  
Larger signal losses in the fibers, but better high multiplicity optical connectors

# FPGA

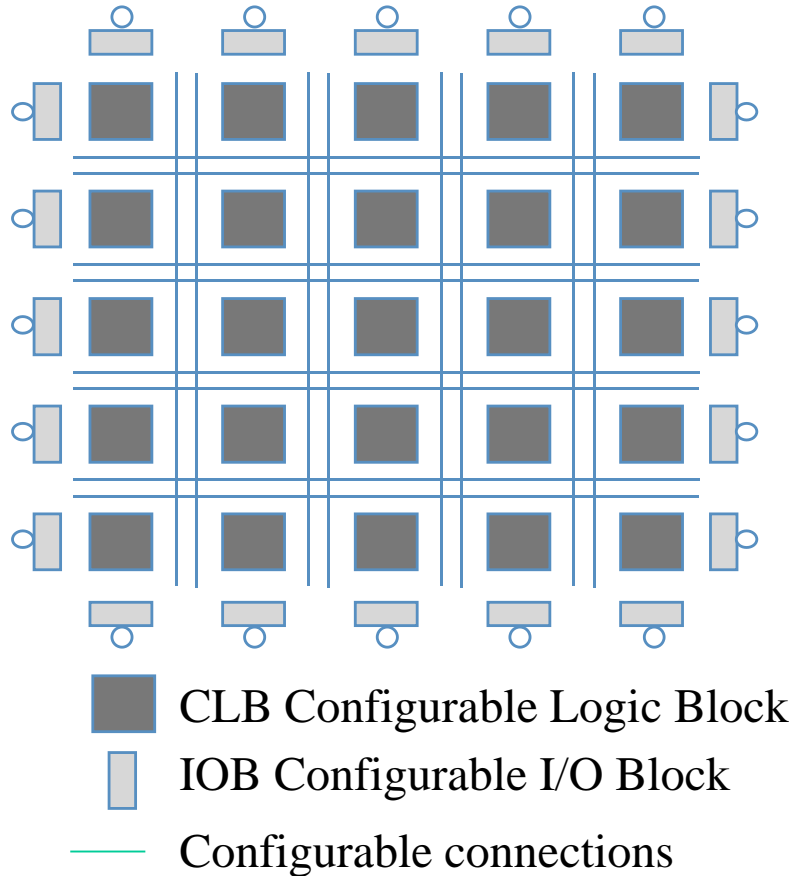

Field Programmable Gate Arrays (FPGAs) has become a standard component when building Data Acquisition and logic systems in general.

The programming is stored in a adjacent memory.

This memory can be volatile or fixed. Volatile memories must be programmed at every start up.

State-of-the-art FPGAs can have up to thousands of CLBs, IOBs , DSP slices and 100ds of Mb on-chip memories

Also many 32 or 58 Gbps high speed connections and on-chip processors etc etc.

Anything is possible... almost  
But high performance costs

# ATLAS Phase-II TDAQ

Present system

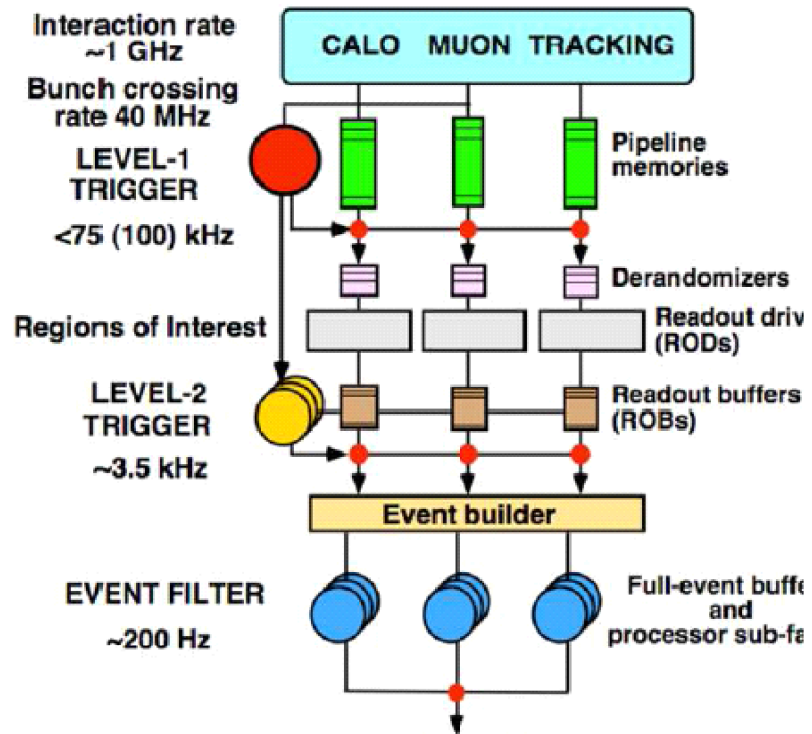

Phase II system

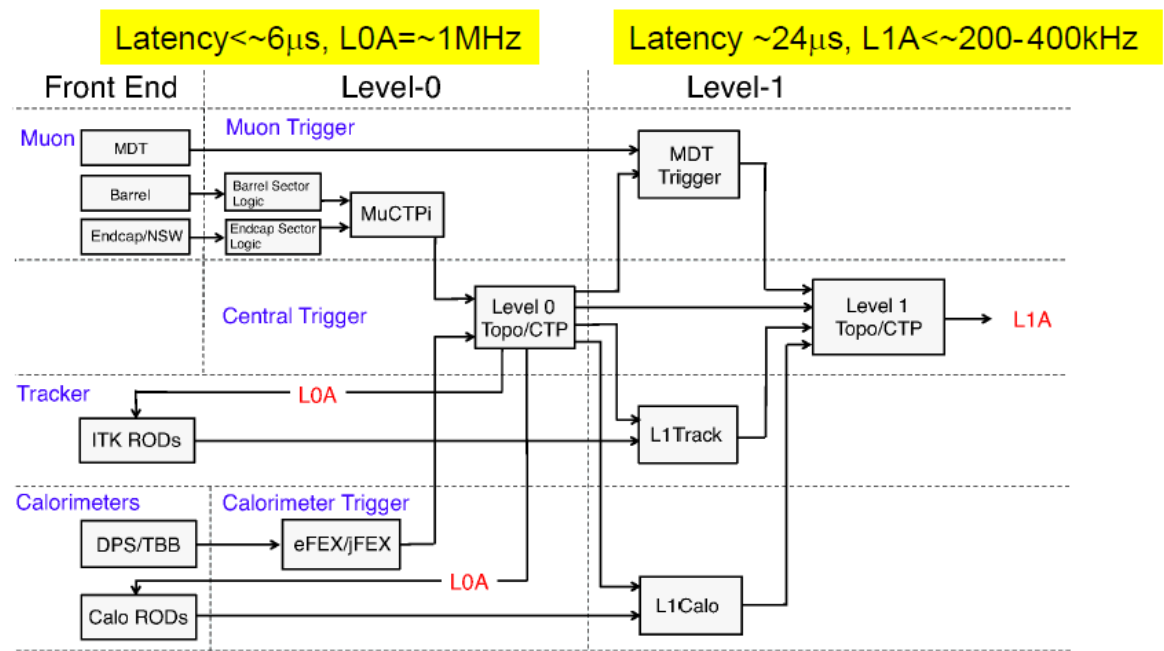

# Phase 2 (LS3) upgraded TileCal electronics

More luminosity → upto 200 event/bunch crossing → more complex trigger processes → require more data → read out all data directly to off detector trigger  
→ Many (4000) 9.6 Gbs links and large FPGAs

New TileCal electronics

Better redundancy, smaller units (failure less costly)

New Low Voltage Power Supplies (partly from South Africa)

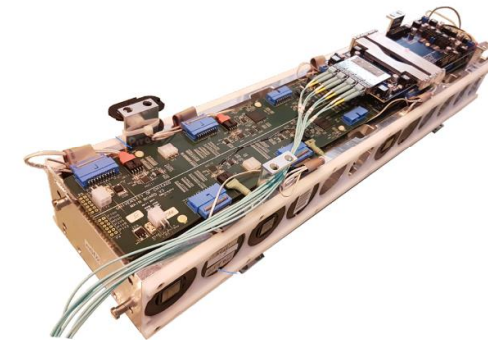
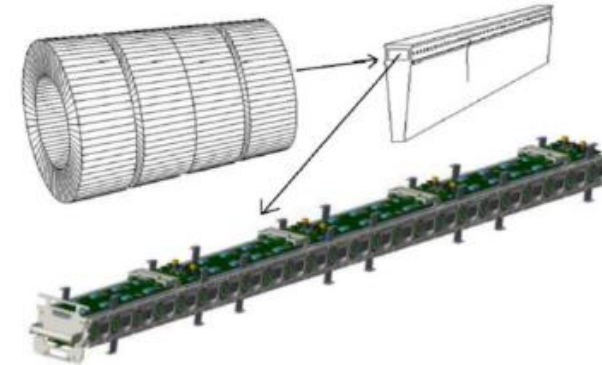

# Front-End example - TileCal

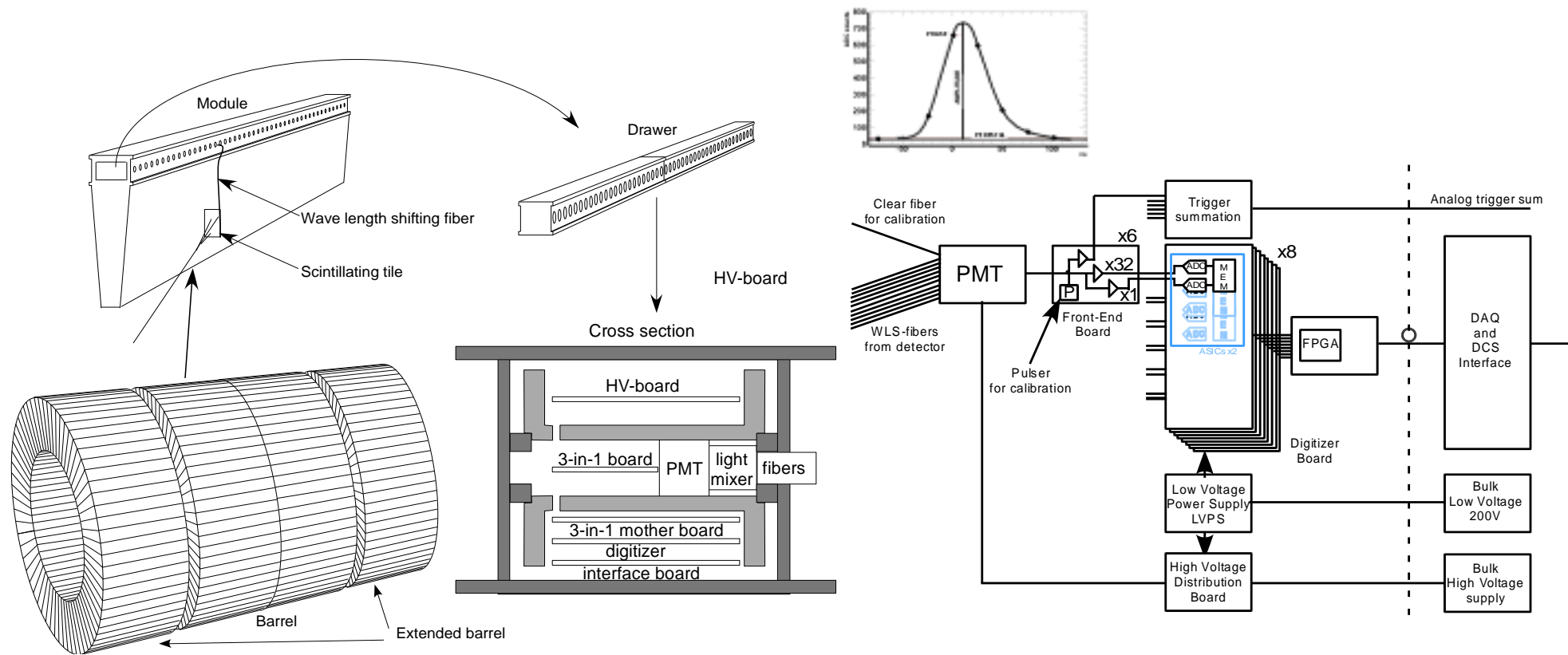

4x64 modules (with electronics in "drawers") with 46 or 32 PMTs each read out by 2 10 bit ADCs (high and low gain)

Each module 8 contains Digitizer boards with 2 ASICs each containing digital pipeline and de-randomizer

Analog trigger signals – digitized in USA-15