

Seeing Quarks and Gluons

50 Years of QCD, UCLA, Sept. 12, 2023

George Sterman, Stony Brook University

1. The fundamental fields reveal themselves
2. Jets from QCD: Following quarks and gluons into the final state
3. Factorizations: Finding universality for initial-state partons
4. Using universality
5. Summary and for the coming years

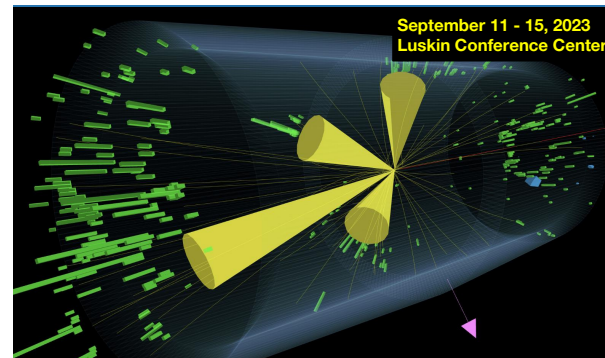

An overview of some of the origins and fundamental concepts of perturbative quantum chromodynamics that are relevant today, with a few recollections from my personal path in QCD.

Recommended additional pQCD overview: Y. Dokshitzer in *50 Years of Quantum Chromodynamics*, 2212.11107

1. The fundamental fields reveal themselves

- **From** $p, n \Rightarrow$

p n N(1440) N(1520) N(1535) N(1650) N(1675) N(1680) N(1700) N(1710) N(1720) N(1900) N(1990) N(2000) N(2080) N(2090) N(2100)
N(2190) N(2200) N(2220) N(2250) N(2600) N(2700) N(3000 Region) Δ (1232) Δ (1600) Δ (1620) Δ (1700) Δ (1750) Δ (1900) Δ (1905)
 Δ (1910) Δ (1920) Δ (1930) Δ (1940) Δ (1950) Δ (2000) Δ (2150) Δ (2200) Δ (2300) Δ (2350) Δ (2390) Δ (2400) Δ (2420) Δ (2750)
 Δ (2950) Δ (3000 Region)

- **Composite yet irreducible? bootstrap \rightarrow strings**

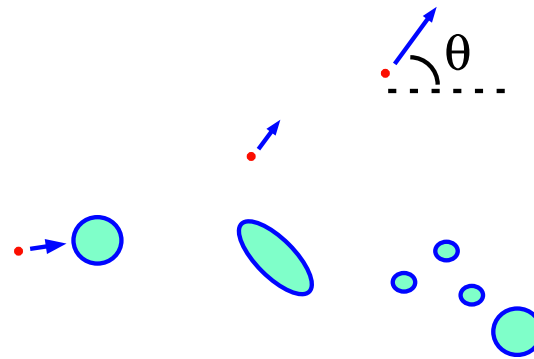

- **Composites of indivisibles? quark model**

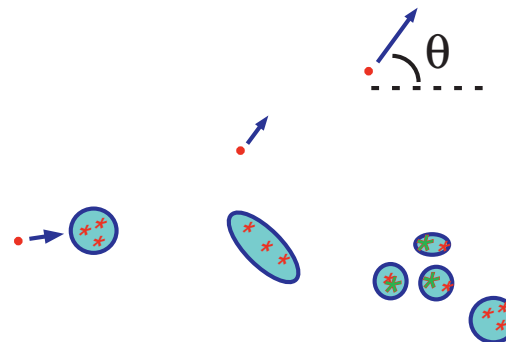

- **Yet are the $\star\star$'s "real"? Confinement**

- In the light of QED ...

$$\frac{g_e - 2}{2} = 1159.6521869 \pm 0.0000041 \times 10^{-6}$$

- Nature makes its choice:

- current algebra: **★★'s provide currents** Yang & Mills:

currents → **vector fields** → **forces**

“This is a very profound idea, perhaps the most profound idea in theoretical physics since the invention of Dirac theory.”

- J.J. Sakurai, Ann. Phys. 11, 1 (1960)

- dipole-like form factors:

★★ small & strongly coupled

- **Lightning strikes: scaling in deep inelastic scattering**
ep inelastic scattering. **The electron sees $\star\star$'s as spin-1/2 point particles**

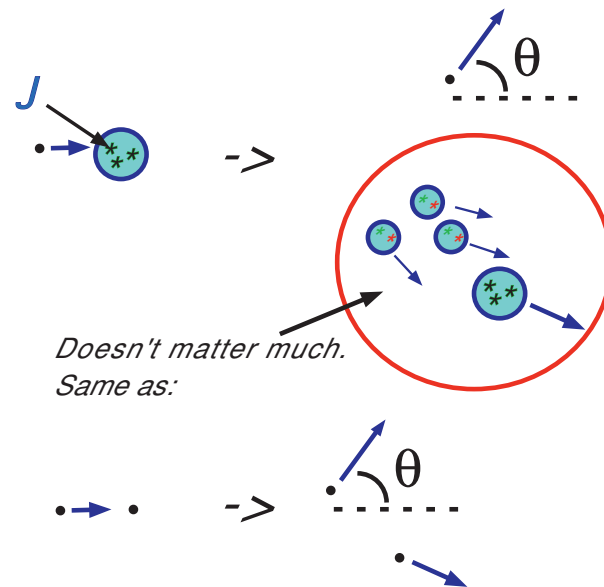

- The “strong” force seems weak, almost irrelevant to the electron that scatters
- The “quark-parton” model of Feynman, Bjorken-Paschos
 - Ignore $\star\star$ interactions, $x = Q^2/2p \cdot q$.
 - $\sigma_{\text{proton}}(P, Q, x) = \sigma_{\text{EM}}(xP, Q) \times$ (probability of parton mtm. xP in the proton)

QFT analysis was ready with Correlations

- pre-1970 **inclusive** DIS analysis in field theory

- EM Current (J) correlators
- For any field theory with coupling $\alpha_s(\mu)$

- Deep-inelastic ep scattering, energy transfer $E = x(Q^2/2m_p)$, momentum transfer Q :

$$\int dx x^{N-1} \sigma_{\text{ep}}(x, Q) \sim \int dx x^{N-1} \langle p | J(Q) J(-Q) | p \rangle$$
$$= C_N(Q/\mu, \alpha_s(\mu)) \langle p | O_N(0) | p \rangle_\mu$$

- $O_N(0)$: local operators
 - μ : scale of the coupling
 - Wilson, Brandt-Preparata, Frishman, Christ-Hasslacher-Mueller
- But the scale of the coupling is our choice, nature doesn't care:

$$\mu \frac{d}{d\mu} \sigma_{\text{ep}}(x, Q) = 0.$$

Separation of variables implies an equation for μ and therefore Q ; *evolution*

$$\mu \frac{d}{d\mu} \ln C_N(Q/\mu, \alpha_s(\mu)) = \gamma^{(1)} \alpha_s(\mu) + \dots$$

- Quantified the paradox: scaling $\rightarrow \alpha_s(Q)$ small,
 \Rightarrow the strong interactions are “weak” in DIS

QUANTUM CHROMODYNAMICS

$$\mathcal{L} = \sum_q \bar{q} (i\not{D} - g\not{A} + m_q) q - \frac{1}{4} F_{\mu\nu}^2[A]$$

- The Y-M theory of quarks (q) and gluons (A)
- Just the right sets of currents
- Just the right kind of forces:
- Compute the T (time) -dependence of:

$$g(h/T) = \text{tree} + \text{loop}(cT) + \text{loop} + \text{loop}$$

$$\alpha_s(Q) = 4\pi/b_0 \ln(Q^2/\Lambda_{\text{QCD}}^2)$$

- Asymptotic freedom \rightarrow scaling Gross-Wilczek, Politzer (1972)
- Near a \star (quark), force is weak \rightarrow scaling?
- Far from a \star , force is strong \rightarrow Infrared strong coupling \rightarrow quark confinement?
- **By the time a struck \star gets far enough to feel a strong force, the electron is long gone. Then, the quark \star 's reassemble into hadrons**

- 1977: A physical picture for evolution

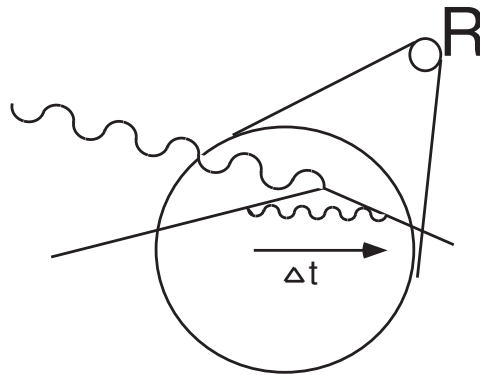
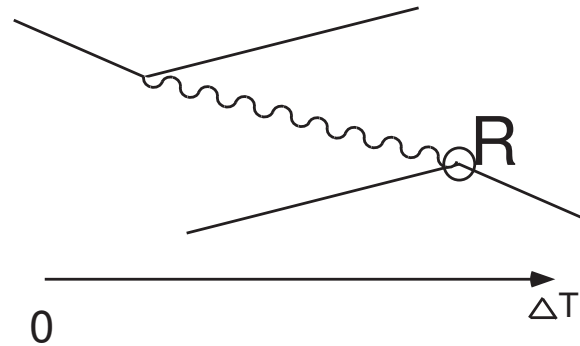

- Dokshitzer, Gribov-Lipatov, Altarelli-Parisi
- Asymptotic freedom is a big deal:

$$\frac{\text{Asymptotic Freedom}}{\text{QCD}} = \frac{\text{Elliptical Orbits}}{\text{Newtonian Gravity}}$$

- A beginning, not an end. For Newtonian gravity, the three-body problem. For QCD ...

HOW TO OBSERVE CONFINED DEGREE OF FREEDOM?

- The goal

$$\frac{\text{Nuclear Physics}}{\text{QCD}} = \frac{\text{Chemistry}}{\text{QED}}$$

- But can we study the particles that

- Give the currents (quarks)?
- Give the forces (gluons)?
- Expand in number of gluons?

Perturbation Theory

- In QCD they're confined: **observed hadrons are bound states**
- Bound-state scattering: **Complexity & strong forces**
- Does this make sense at all?
- **More analogies: atoms before observation of radioactivity & molecules before the explanation of Brownian motion**

3. JETS FROM QCD: FOLLOWING QUARKS AND GLUONS INTO THE FINAL STATE

- **Learning to calculate with the the then-new theory:**

Correlation functions *vs.* the *S*-matrix

- Correlation functions at short distances: **PT-friendly**

$$\begin{aligned}\langle 0|J(x) J(0)|0\rangle &= C(x\mu, \alpha_s(\mu)) \\ &= C(1, \alpha_s(1/x))\end{aligned}$$

– e^+e^- annihilation cross section (Appelquist & Georgi, Phys. Rev. (1973))

- The *S*-matrix, even at high energy: **pretty hopeless in PT**

$$\begin{aligned}\langle B \text{ out}|A \text{ in}\rangle &= f(Q/\mu, m/\mu, \alpha_s(\mu)) \\ &= f(1, m/Q, \alpha_s(Q)) \\ &= f(Q/m, 1, \alpha_s(m))\end{aligned}$$

– m – mass scales: $m_\pi, m_p, m_q, m_G(= 0) \dots$

– **Still, it's only the ratio m/Q that causes the problem**

- Were we doomed to compute only correlations of currents?
- **Were we *forbidden* to look inside the final state?**
- **Or, could it be possible to “see” quarks and gluons?**

The structure of final states: From cosmic rays to quark pairs

- Particle jets in cosmic rays ...
 - “The average transverse momentum resulting from our measurements is $p_T=0.5$ BeV/c for pions ... Table 1 gives a summary of jet events observed to date ...”
 - B. Edwards et al, Phil. Mag. 3, 237 (1957)
 - Limited transverse momentum in secondaries of hadron collisions
 - What about quarks produced in e^+e^- annihilation?

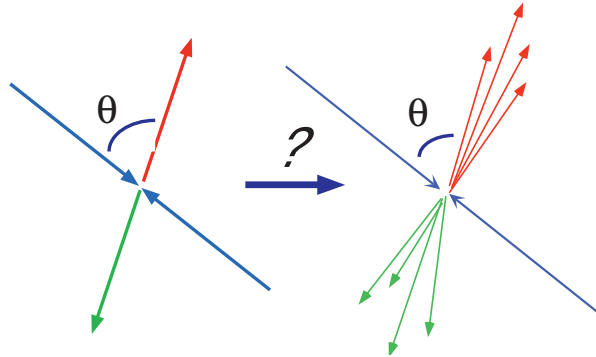

- **Extension of the parton model: q/e scattering to $e^+e^- \rightarrow q\bar{q}$. Conjecture p_T -cutoff.**
 - **A prediction for the angular distribution: $1 + \cos^2 \theta$**
 - “Because of our cutoff $k_{\max} \ll |q| \dots$ The distribution of secondaries in the colliding ring frame will look like two jets ...” S.D. Drell, D.J. Levy and T.-M. Yan, Phys. Rev. D1
 - **Here was a question to ask of QCD. Would the final state look like this?**
 - **It did: – G. Hanson et al, Phys. Rev. Lett. 35, 1609 (1975)**

JETS FROM QCD

- How I came to study e^+e^- final states
 - Thesis (UMD) in the echos of the old and stirrings of the new:
 - complex analysis of scattering amplitudes (advisor: Alex Dragt)
 - perturbative form factors in a Yukawa model (Joseph Sucher and Ching Hung Woo)
- Discussions at Urbana with Shau-Jin Chang and Jeremiah Sullivan, from CEA data to $J/\Psi \dots R_{\text{hadron}}$ in Litke, G. Hanson et al. 1973 ... Davier et al. 2019

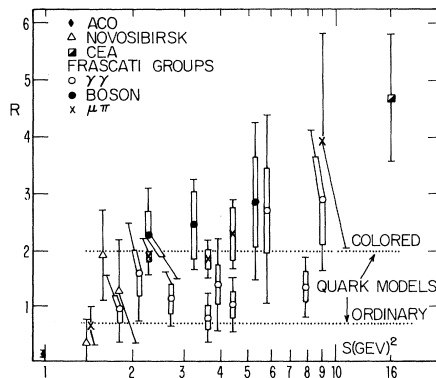

FIG. 2. $R = \sigma(e^+e^- \rightarrow \text{multibody hadrons}) / \sigma(e^+e^- \rightarrow \mu^+\mu^-)$ versus the square of the center-of-mass energy s in GeV^2 . The dotted lines give the asymptotic predictions of parton models assuming ordinary and colored quarks.

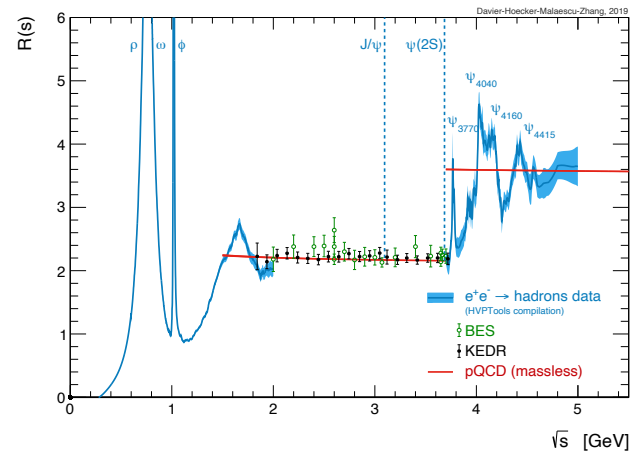

Fig. 8. The total hadronic e^+e^- annihilation rate R as a function of centre-of-mass energy. Inclusive measurements from BES [49] and KEDR [50, 51] are shown as data points, while the sum of exclusive channels from this analysis is given by the narrow blue bands. Also shown for the purpose of illustration is the prediction from massless perturbative QCD (solid red line).

- **Could $\sigma_{e^+e^-}^{\text{tot}}$ increase with Q ? (No). We were seeing the cross section respond to the charm threshold.**
- Out of which came ...

An abstract question; an abstract answer

- QED: exclusive cross sections typically infrared divergent

$$\sigma_{AB}^{(1)}(Q, m_e, m_\gamma \rightarrow 0, \alpha_{\text{EM}}) \sim \alpha_{\text{EM}} \beta_{AB}(Q/m_e) \ln \frac{m_\gamma}{Q}$$

- Energy resolution ϵQ (Bloch-Nordsieck)
→ IR finiteness (sum over $E_\gamma \leq \epsilon Q$)

$$\bar{\sigma}_{AB}^{(1)}(Q, m_e, \epsilon Q, \alpha_{\text{EM}}) \sim \alpha_{\text{EM}} \beta_{AB}(Q/m_e) \ln \frac{1}{\epsilon}$$

- **Impossibility of resolving arbitrarily soft photons**
(Yennie, Frautschi, Suura, *Ann. Phys.* 13 (1961)):

380

YENNIE, FRAUTSCHI, AND SUURA

1. INTRODUCTION

The essential idea for the understanding of the infrared divergence problem was first brought out by Bloch and Nordsieck in their famous paper, published a little over two decades ago (1). In brief, this idea is that in any practical experiment involving charged particles it is impossible to specify completely the final state of the system. Because individual photons can be emitted with arbitrarily small energies, there will always be a possibility that some photons will escape detection. In fact, they showed that the probability that only a finite number of photons will escape detection is precisely zero; this is due to the

- Could something like this happen:
 - For QED with $m_e = 0$?
 - For QCD with $m_q = 0$?
 - Kinoshita, Lee-Nauenberg
- See: a prescient footnote from S. Weinberg “Soft gravitons and photons” PR 140 (1965)

³ The extra divergences in massless quantum electrodynamics have long been known to many theorists. Recently, it has been noted by T. D. Lee and M. Nauenberg, Phys. Rev. **133**, B1549 (1964), that these divergences cancel if transition rates are computed only between suitable ensembles of final *and initial* states. [See also T. Kinoshita, J. Math. Phys. **3**, 650 (1962)]. However, these ensembles include not only indefinite numbers of very soft quanta but also hard massless particles with indefinite energies, and I remain unconvinced that transition rates between such ensembles are the only ones that can be measured and need be finite.

- After some thought, it turned out that:
 - ϵ not enough . . . but with an extra *angular* resolution δ , it works.
 - Impossibility of resolving collinear massless particles.
 - Changing focus from dimensional p_T to dimensionless δ natural for renormalizable theory with conformal limit.

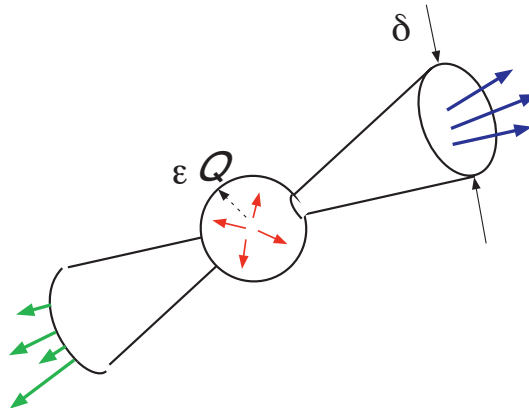

- No large ratios Q/m : **Infrared Safety.**
- Trade high-energy for zero-mass limit.

- **New class of observables: Jet Cross sections**

$$\sigma(Q/\mu, \alpha_s(\mu), \epsilon, \delta) = \sigma(1, \delta, \epsilon, \alpha_s(Q))$$

- **“We define two states [to be] “jet-related” if they differ by the emission or absorption of a number of zero energy particles, or by the transformation of one set of parallel moving particles into another ...” GS ILL-(Th)-75-32 (preprint)**

Our ensembles will thus be specified in terms of sets of jet-related states. To make this idea more quantitative we define for any state \underline{a} , an "angular energy current" in the e^+e^- CM frame:

$$j_{\underline{a}}(\Omega) = \sum_{i=1}^{n_{\underline{a}}} \eta_i \delta(\Omega - \omega_i) \quad (1)$$

where the sum is over the $n_{\underline{a}}$ massless particles in \underline{a} , with energies $\{\eta_i\}$ and momentum directions $\{\omega_i\}$ (ω_i stands for angles θ_i and φ_i). Jet-related states have the same $j(\Omega)$. Each group of particles with collinear momenta may be described as a jet, and any set of jet-related states is characterized by the number of jets, as well as their energies and directions.

- **Energy flow becomes the focus of computability.**
- **Not, alas, accepted for publication. But in some ways my good fortune, given how it worked out (and, $\ln^2 \delta$ should have been $\ln \delta \ln \epsilon$!)**

- In the tradition of Poynting: energy flow in gauge theories
- Slow discharge of a condenser (Poynting). Fast neutralization of a color dipole (LEP)

ON THE TRANSFER OF ENERGY IN THE
ELECTROMAGNETIC FIELD.

[*Phil. Trans.* 175, 1884, pp. 343-361.]

[Received December 17, 1883. Read January 10, 1884.]

A space containing electric currents may be regarded as a field where energy is transformed at certain points into the electric and magnetic kinds by means of batteries, dynamos, thermoelectric actions, and so on, while in other parts of the field this energy is again transformed into heat, work done by electromagnetic forces, or any form of energy yielded by currents.

On interpreting the expression it is found that it implies that the energy flows as stated before, that is, perpendicularly to the plane containing the lines of electric and magnetic force, that the amount crossing unit area per second of this plane is equal to the product

$$\frac{\text{electromotive intensity} \times \text{magnetic intensity} \times \text{sine included angle}}{4\pi},$$

while the direction of flow is given by the three quantities, electromotive intensity, magnetic intensity, flow of energy, being in right-handed order.

(2) *Discharge of a condenser through a wire.*

We shall first consider the case of the slow discharge of a simple condenser consisting of two charged parallel plates when connected by a wire of very great resistance, as in this case we can form an approximate idea of the actual path of the energy.

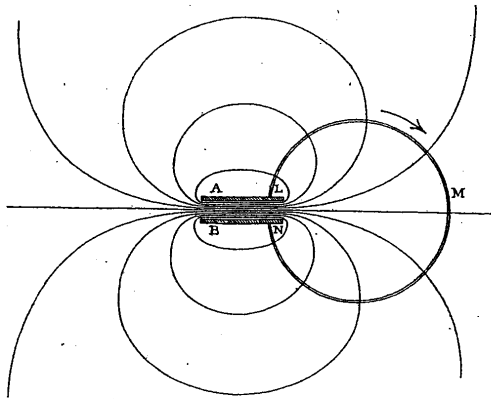
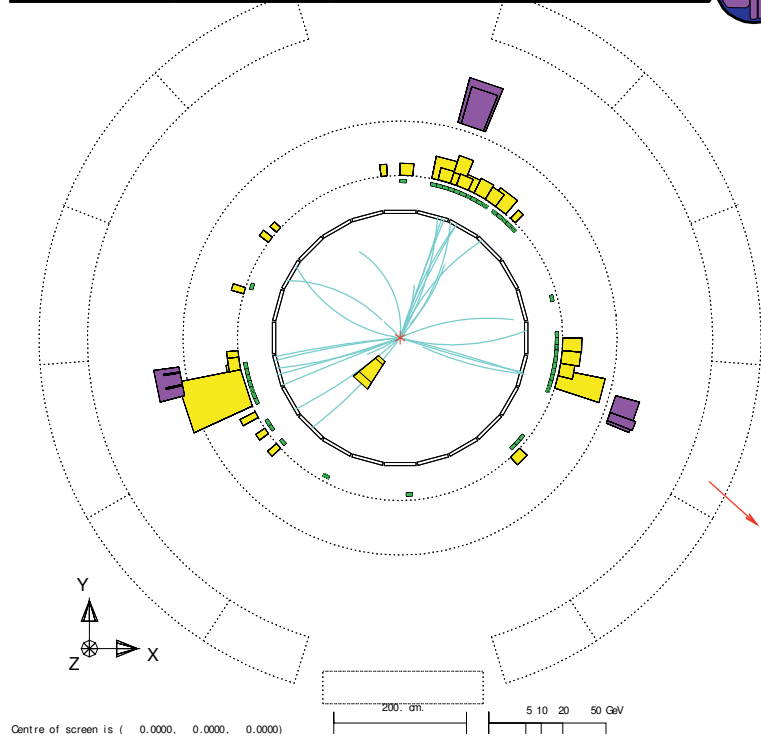

Fig. 2.

Run:event 2542: 63750 Date 911014 Time 36925Clrk(N= 28 Smp= 42.1) Ecal(N= 42 SntE= 59.8) Hbal(N= 8 SntE= 12.7)
Beam 45.609 Evis 88.2 Eris 5.0 Vlx (-0.05, 0.12, -0.90) Mion(N= 1) Sec Vlx(N= 0) Fdet(N= 2 SntE= 0.0)
Bz=4.350 Thrust=0.8223 Aplm=0.0120 Orlat=-0.3338 Spher=0.2463



- How this idea become known, and a bit of my own story . . .
- Thanks to: Jim Carrazone for a seminar invitation to Fermilab, to Tom Appelquist, on sabbatical at Fermilab, who heard my talk there and reported the work at a “Coral Gables” conference, to (advisor) Joe Sucher who told attendees I needed a 2nd postdoc. To Tom Kinoshita who remembered my work a year later, and to its independent inventor, Steven Weinberg.
- S.W. recounted developing the idea while on sabbatical at SLAC, where the jet observation had recently been made by Hanson et al., then making phone calls to see how had worked on the mass divergence problem. T. Kinoshita knew of the preprint and referred S.W. to G.S.
- This led eventually to a phone collaboration between G.S. and S. Weinberg, and to Phys. Rev. Lett. 1977, “Jets from Quantum Chromodynamics”: Zero-mass limit as a diagnostic for perturbative calculability. What became known as “Infrared safety”.
- S. Weinberg to G. Sterman (as recalled) “if we join forces, I believe we will succeed”

- In fact, it turned out to be a little more complicated than we anticipated:

September 12, 1977

Dr. Steven Weinberg
Lyman Laboratory of Physics
Harvard University
Cambridge, Mass. 02138

Dear Dr. Weinberg:

The manuscript by G. Sterman and S. Weinberg entitled "Jets from Quantum Chromodynamics" has been reviewed by our referee(s). While some of the referees' comments were favorable, there were also scientific criticisms which were so strongly adverse that we cannot accept your paper on the basis of material now at hand. We are therefore returning your manuscript herewith, together with a copy of the pertinent criticism.

If you wish to reply, the paper will be given further consideration.

- Happily, PRL reconsidered after the acceptance of papers based on our work by Edward Farhi (thrust) and by Howard Georgi & Marie Machacek (spherocity), both listed as received on Sept. 26, 1977. Basham, Brown, Ellis and Love on radiation pattern and energy correlations (PRD, PRL, 1978) followed shortly.

What is Infrared Safety?

- Infrared Safety: “quantities . . . predictable . . . if: (a) they are finite in QCD perturbation theory and the perturbation series is sufficiently convergent, and (b) non-perturbative effects are not obviously dominant.”
 - A. de Rújula, J. Ellis, E.G. Floratos and M.K. Gaillard, Nucl. Phys. B138 (1978) 387
- Became updated as:
QCD perturbation theory gives self-consistent predictions for a quantity C when C :
 - is dominated by short-distance dynamics in the infrared-regulated theory;
 - remains finite when the regulation is taken away.
- Contemporary update (or aspiration): C is IR safe when C can be computed directly in four dimensions. (Torres-Bobadilla et al. Eur. Phys. J. 2022, Anastasiou & GS, 2022).
- Infrared Safety is not the only concept that leads to consistent perturbative analysis: In “Parton-hadron duality”, extend calculability by the identification of parton & hadron multiplicities at some cutoff. Dokshitzer, Diakanov, Troian Phys. Rep. 58 (1980)
 - This duality is built into event generators with models for hadronization.
- Perturbative QCD is much, much more than just jet cross sections. But they lay the groundwork, and at Tevatron and especially LHC, they have become a ubiquitous tool (Salam, Soyez, Cacciari . . .) see other talks in this conference.

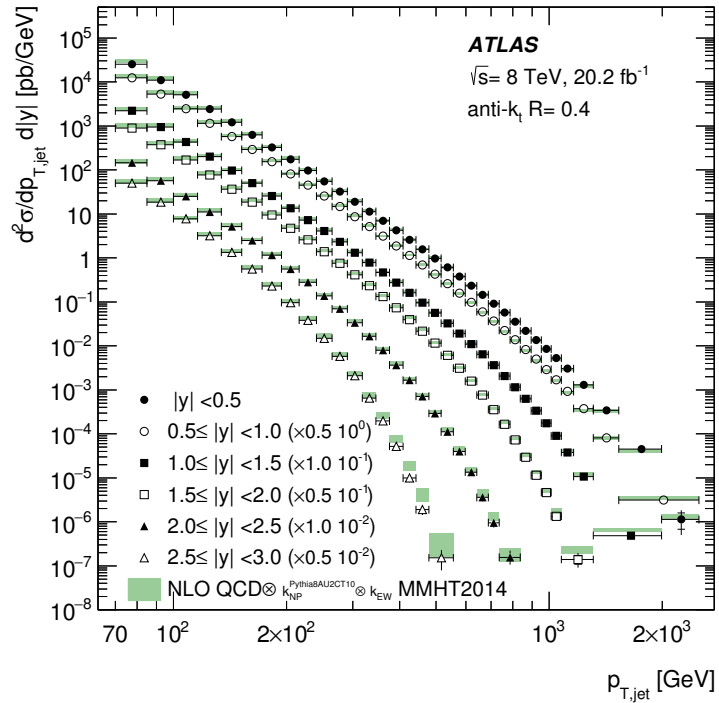

Figure 5: Inclusive jet cross-section as a function of jet p_T in bins of jet rapidity. The results are shown for jets identified using the anti- k_T algorithm with $R = 0.4$. For better visibility the cross-sections are multiplied by the factors indicated in the legend. The data are compared to the NLO QCD prediction with the MMHT2014 PDF set corrected for non-perturbative and electroweak effects. The error bars indicate the statistical uncertainty and the systematic uncertainty in the measurement added in quadrature. The statistical uncertainty is shown separately by the inner vertical line.

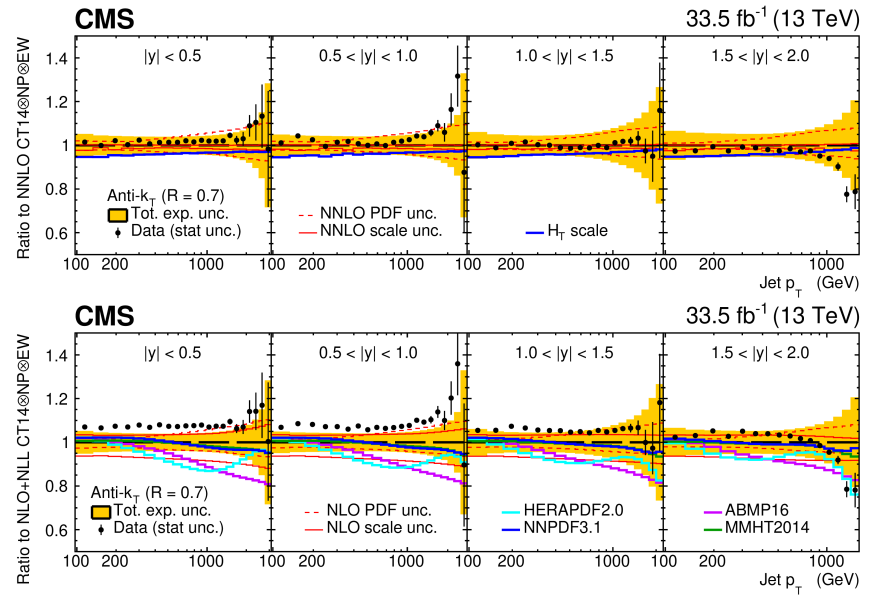
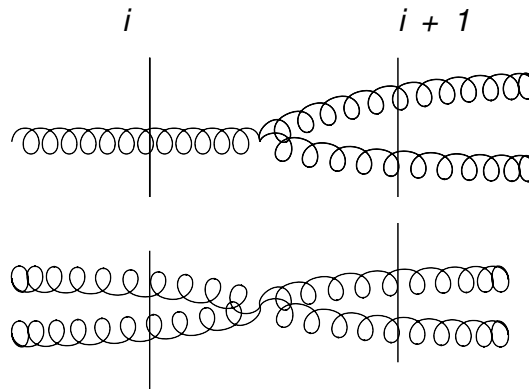

Figure 1: The double-differential inclusive jet cross sections as a function of jet p_T measured in intervals of $|y|$ shown with jet distance parameter $R = 0.7$. The data are divided by NNLO (upper panel) and NLO+NLL predictions (lower panel) [5].

A few general viewpoints that lead to general results

- IR logarithms arise from coalescing mass-shell ($k^2 = 0$) poles in loop integrals, “pinches”. (Landau equations with Coleman-Norton analysis; see Eden et al *The Analytic S-matrix* 1966). We look for observables that are insensitive to these)
- The basic finding: **Long distance behavior** \leftrightarrow **classical propagation in massless theory**
 - An analog of the correspondence principle, where classical and quantum pictures overlap
 - Jet substructure is long-distance dominated because massless particles can propagate classically between interactions when they preserve the flow of energy.



- Such configurations are very restrictive at high energy, and reduce to parton-model like pictures.

CLASSICAL KINEMATICS EMBEDDED IN AMPLITUDES
 THE UNDERLYING SINGULAR REGIONS
 (Black lines represent "jet" subdiagrams)

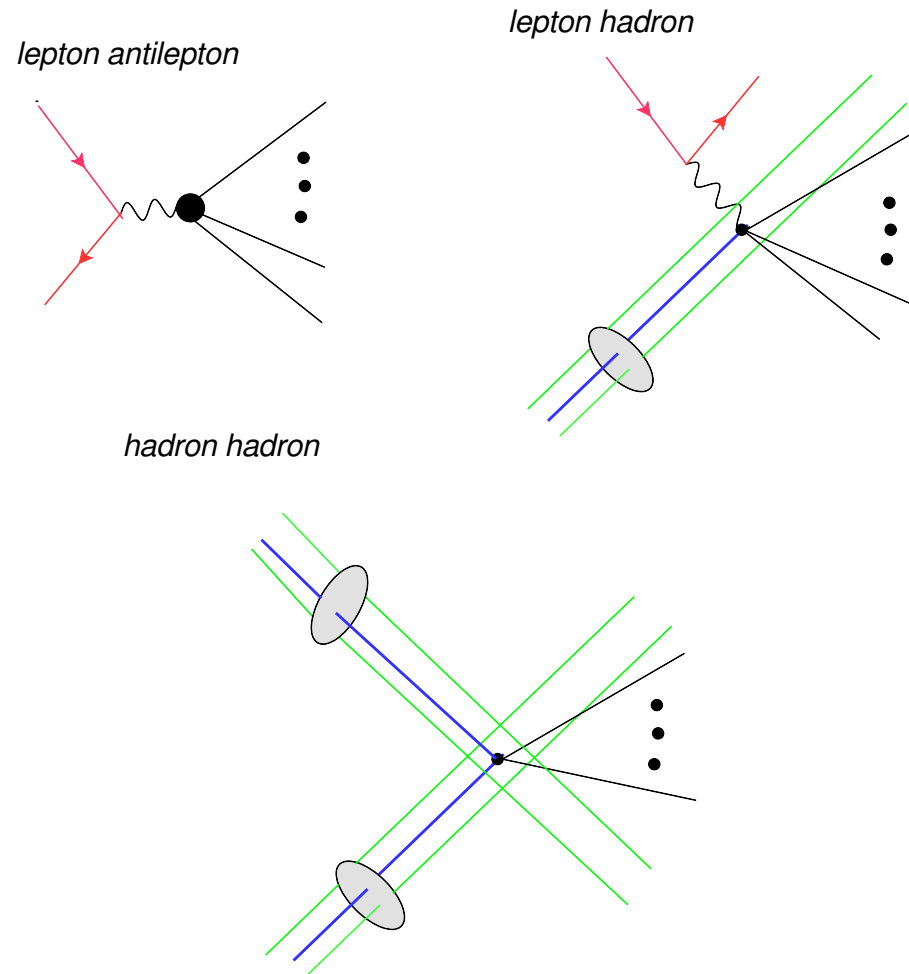

- In each case, interactions between outgoing jets involve no local momentum transfer.
- Logarithms we organize in evolution or resummation result from integrals up to these momentum configurations.

- In gauge theory, the classical processes are dressed by soft vectors . . .

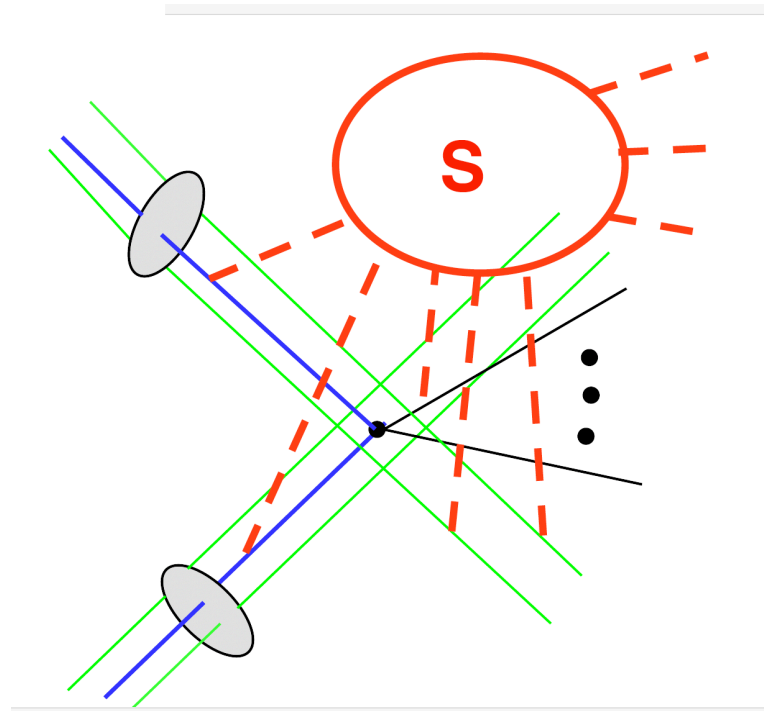

- A little more on how jet cross sections impose locality.

- For leptonic annihilation (as in all cases), all final states are familiar hadrons, with nothing special about them to tell the tale of QCD, $|N\rangle = |\text{pions, protons...}\rangle$,

$$\sigma_{e^+e^- \rightarrow \text{hadrons}}(Q) \propto \sum_N \langle 0 | j_{\text{em}}^\mu(0) | N \rangle \langle N | j_{\text{em},\mu}(0) | 0 \rangle \delta^4(Q - p_N)$$

- On the other hand, $\sum_N |N\rangle \langle N| = 1$, and using translation invariance this gives

$$\sigma_{e^+e^- \rightarrow \text{hadrons}}(Q) \propto \text{Im} \int d^4x e^{-iQ \cdot x} \langle 0 | T(j_{\text{em}}^\mu(0) j_{\text{em}}^\mu(x)) | 0 \rangle$$

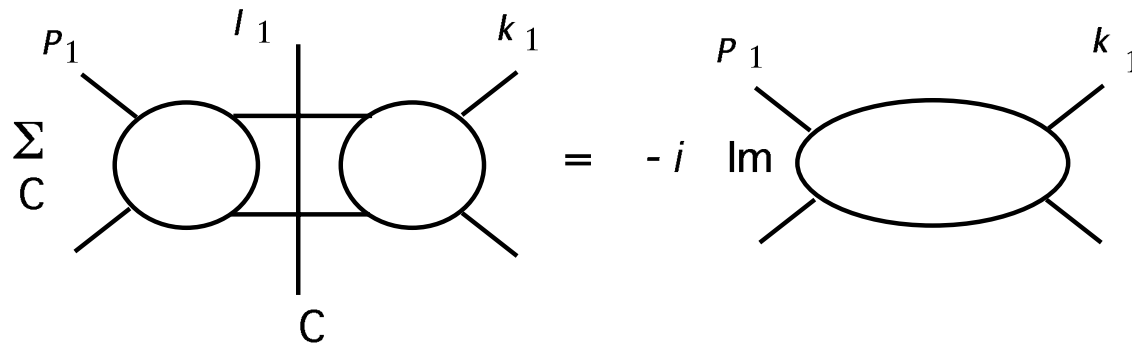

- On the RHS there are no classical pictures connecting $J(0)$ and $J(x)$ by jets in diagrams for the matrix element \rightarrow the total cross section is IR safe.
- After summing over states, we are probing the vacuum at short distances, imposed by the Fourier transform as $Q \rightarrow \infty$. The currents are only a distance $1/Q$ apart.

- But what about 2- or more-jet cross sections? We can't use the same unitarity ...

$$\sigma_{e^+e^- \rightarrow \text{jets}}(Q) \propto \sum_N \Theta(N \in \text{JetStates}) \langle 0 | j_{\text{em}}^\mu(0) | N \rangle \langle N | j_{\text{em},\mu}(0) | 0 \rangle \delta^4(Q - p_N)$$

- **But, each set of “jet-related” states has its own unitarity! ... (GS PRD 1978)**

Next we can sum over all possible cuts α of G . Grouping the terms by τ orderings of G ,

$$\sum_{\alpha} g^{(\alpha)} = \int \left(\prod_{i=1}^L dk_i^+ d^2\vec{k}_i \right) \prod_{j=1}^N \frac{\theta(l_j^+)}{|l_j^+|} \sum_{T(G)} \sum_{\alpha} \prod_{\beta} (q^- - S_{\beta} + i\epsilon)^{-1} \delta(q^- - S_{\alpha}) \prod_{\beta'} (q^- - S_{\beta'} - i\epsilon)^{-1}, \quad (2.9)$$

$$\sum_{\alpha} g^{(\alpha)} = i \int \left(\prod_{i=1}^L dk_i^+ d^2\vec{k}_i \right) \prod_{j=1}^N \frac{\theta(l_j^+)}{|l_j^+|} \sum_{T(G)} \left[\prod_{\gamma} (q^- - S_{\gamma} + i\epsilon)^{-1} - \prod_{\gamma} (q^- - S_{\gamma} - i\epsilon)^{-1} \right]. \quad (2.10)$$

- Summing over jet-related states removes all pinches & long time behavior.
- **The two currents are drawn together in space-time by the measurement, the sum over states.** Depends only on a hermitian Hamiltonian.
 - Part of what underlies SCET. Also derived in loop-tree duality formalism by Capatti, Hirschi, Ruiji (JHEP 2022).
- But of course, we can't sum over the states we prepare with hadrons in the initial state.

3. FACTORIZATION: FINDING UNIVERSALITY FOR INITIAL-STATE PARTONS

- Generalize to incoming hadrons (as for cosmic rays)
- In DIS: incoming hadron is a single-particle jet – supplies quark with momentum fraction y :

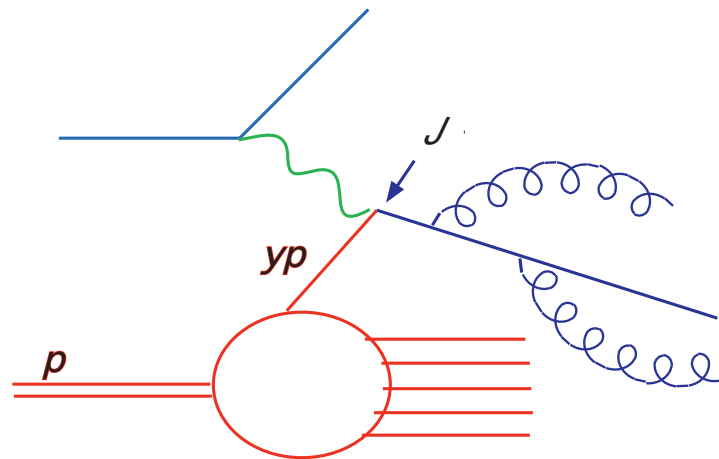

- Factorization:

$$W_N(q, p) = \sum_{a=\mathcal{Q}, \bar{\mathcal{Q}}, \mathcal{G}} \int_x^1 dy C_a \left(\frac{q^2}{\mu^2}, \frac{x}{y}, \alpha_s(\mu) \right) f_{a/N}(y, \mu).$$

- And for hadron-hadron scattering: electroweak annihilation (Drell-Yan) and jets again

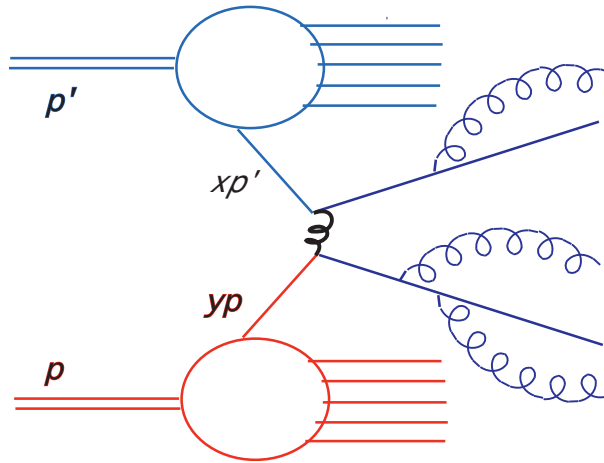

- Factorization (here, Drell-Yan):

$$\frac{d\sigma_{AB}}{dQ^2 dy} = \sum_{a,b} \int_0^1 d\xi_a d\xi_b f_{a/A}(\xi_a, \mu) H_{ab} \left(\frac{x_a}{\xi_a}, \frac{x_b}{\xi_b}, \frac{Q}{\mu}, Q^2, \alpha_s(\mu) \right) f_{b/B}(\xi_b, \mu).$$

- The assertion is that, as in the parton model, the parton distributions for Drell-Yan are the same as those in DIS, and indeed are the same for QCD production of hadron jets when suitably defined in terms of energy flow.
- Program emerged from work of: **Mueller (1974), Politzer (1977)**
- Then on to all orders **Amati, Petronzio & Veneziano; Efremov & Radyushkin; Ellis, Georgi, Machacek, Politzer & Ross; Mueller; Libby, GS (all 1978)**
- Right around the same time as factorization and evolution in elastic amplitudes (Brodsky & Lepage, Efremov & Radyushkin)

- **Physical bases of factorization: locality, causality and unitarity.**
 - **Locality:** hard interactions are mediated by strong or EW currents at short distances
 - **Unitarity:** once the hard scattering occurs, final-state interactions can't undue it, and corrections cancel in inclusive cross section based on energy flow.
 - **Causality:** protons can't mutually polarize each other while they approach at the speed of light. Gluons and massless quarks evolve independently if they recede at c .
 - Gauge theory's unphysical degrees of freedom made this challenging.
(In pQCD, scalar=longitudinal polarizations are pure gauge artifacts.)

- For example, local unitarity is needed to separate hard scattering from soft interactions in hadron-hadron scattering, in “cut diagram” notation.

From Libby & GS (1978): Terms on left generically leading power and singular. Terms on the right are power suppressed because at least one soft line disappears into a sub-diagram that is off-shell. (higher-dimension operator)

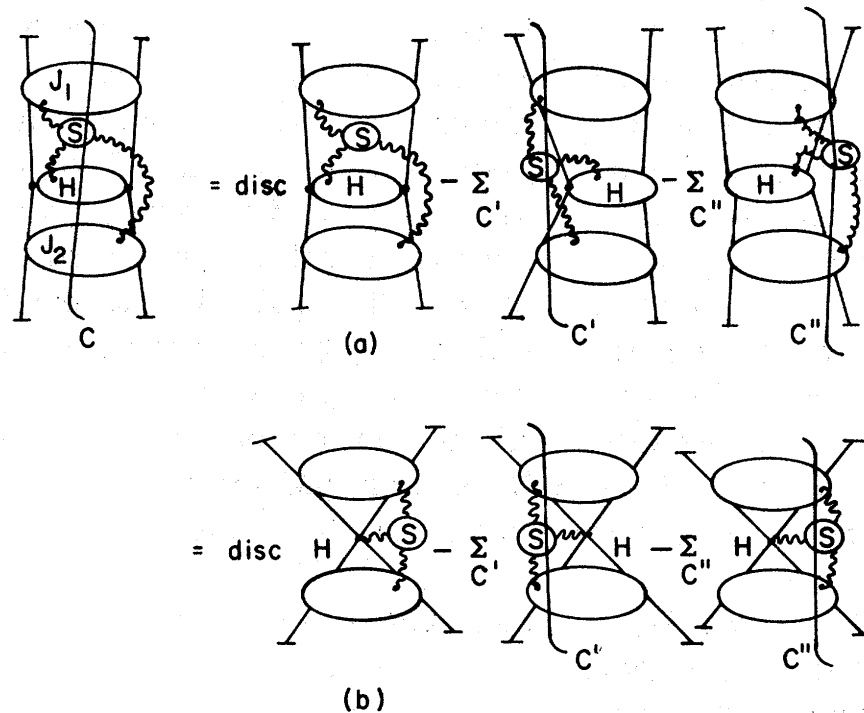

FIG. 7. Cut reduced diagrams illustrating cancellation of IR divergences when soft lines attach to hard subdiagram H .

- **Analysis made well-defined by QFT analysis of parton distributions; culminating in Collins & Soper 1982:**

$$\mathcal{P}_{f/A}(x, k_T, \zeta) = \frac{1}{2(2\pi)^3} \int dy^- d^2 y_T e^{-i(xP^+ y^- - k_T \cdot y_T)} \text{Tr} \gamma^+ \langle P | \psi_f(0, y^-, y_T) \bar{\psi}_f(0) | P \rangle \quad (2.2)$$

and the gluon distribution:

$$\begin{aligned} \mathcal{P}_{g/A}(x, k_T, \zeta) = & -\frac{1}{xP^+(2\pi)^3} \int dy^- d^2 y_T e^{-i(xP^+ y^- - k_T \cdot y_T)} \\ & \times \langle P | \hat{F}_a(0, y^-, y_T)^+_{\mu} \hat{F}_a(0)^{+\mu} | P \rangle, \end{aligned} \quad (2.3)$$

where $\hat{F}_{\mu\nu} = \partial_\mu A_\nu - \partial_\nu A_\mu$. All the definitions (2.1) to (2.3) are normalized so that in free field theory with A replaced by a parton state

$$\mathcal{P}_{a/b}(x, k_T) = \delta_{ab} \delta(x-1) \delta^{(2)}(\mathbf{k}_T).$$

For the remainder of this section and the next section we will be concerned with the distributions integrated over k_T . We find it convenient to make these definitions gauge invariant. The ultraviolet divergences [5] that arise as $k_T \rightarrow \infty$ can be dimensionally regulated and in sect. 3 we will renormalize them away. Our definition of the gauge-invariant quark distribution is

$$\begin{aligned} f_{f/A}^{(0)}(x) = & \frac{1}{4\pi} \int dy^- e^{-ixP^+ y^-} \langle P | \bar{\psi}_f^{(0)}(0, y^-, 0_T) \gamma^+ \\ & \times \text{P exp} \left[ig^{(0)} \int_0^{y^-} d\bar{y}^- A_a^{(0)+}(0, \bar{y}^-, 0_T) t_a \right] \psi_f^{(0)}(0) | P \rangle_c, \end{aligned} \quad (2.4)$$

- **The Wilson lines summarize the effects of gauge degrees of freedom: at high energy, to partons the rest of the world consists of a source of unphysically-polarized gluons, emerging from the opposite light cone.**

- **Historically, another round of factorization studies concerned exchanges cancelled in the sum over final states. (The period I had the good fortune to work with John Collins and Dave Soper.)**
- **Collins & GS (1981), Brodsky, Bodwin and Lepage (1981); Collins, Soper, & GS (1985,88), Bodwin (1985); Aybat & GS (2008), J.C. Collins (*Foundations of pQCD* (2011))**
- **These papers looked more closely at how final-state interactions really cancel.**
- **Here's a representative sequence from Collins, Soper, GS (1985):**

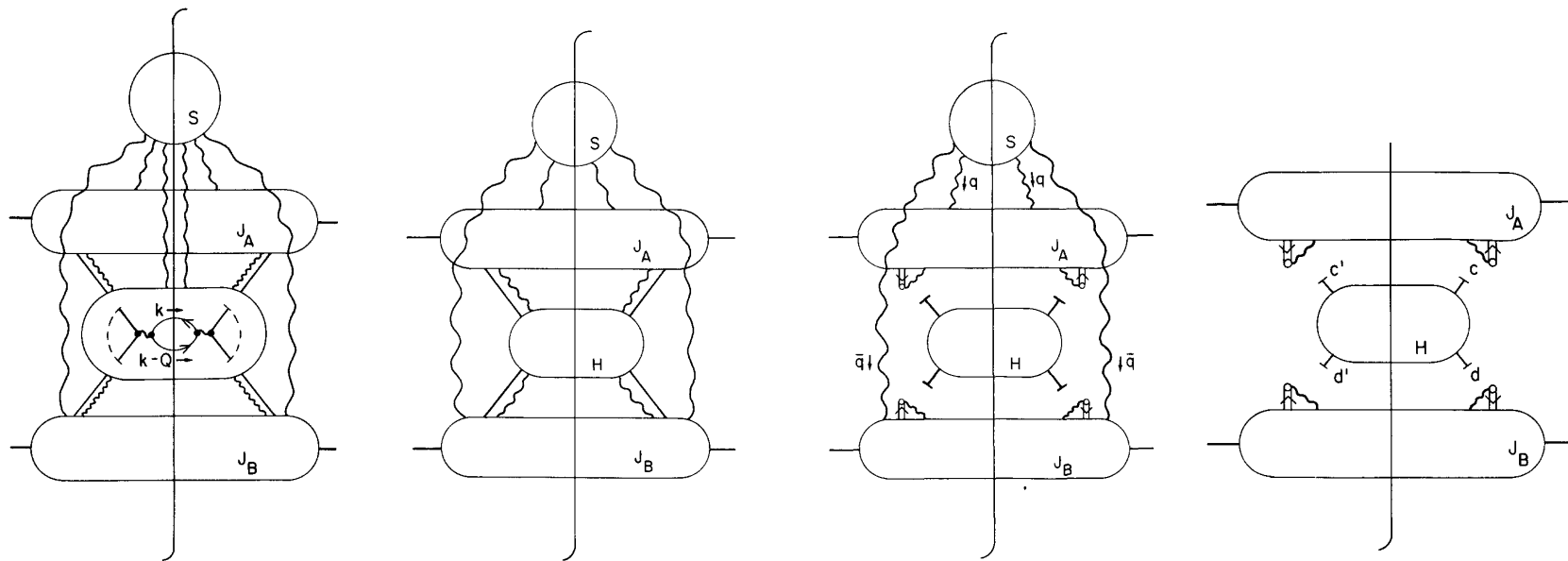

- **Ward identities mediate the transition from the second to third and third to fourth pictures.**

- **When “collinear” factorization is not enough, it gets even more interesting.**
- **Causality ensures that outgoing jets do not exchange momenta with each other, except through soft lines. Interactions with scattering centers “lying in wait” are another matter. Corrections due to scattering from spectators are power-suppressed (GS and J.W. Qiu, NPB 1991), but this effect can be large in dense media (AA!).**
- **Factorization as above also assumes partons are “dilute” in hadrons – at small x this fails, and again power corrections may dominate. Expansions in $f_{G/h}(x)/R_H^2 Q^2$. (Gribov, Levin, & Ryskin, Phys. Rep. 1983; Mueller & Qiu, NPB 1985; ... CGC)**
- **Small- x in DIS opens the door to the total cross section, organized by logs of x rather than Q , and perturbative pictures of the pomeron, the shadow of the total cross section (Balitsky, Fadin, Kuraev, Lipatov, Sov. J. Nucl. Phys., 1977, 1978 ...)**
- **Another connection: to mathematics of solvable models: Lipatov (1993); Fadeev & Korchemsky (1995) ...**

4. USING FACTORIZATION AND UNIVERSALITY

- Introducing hierarchical scales in measurements
- Factorization and/or effective theory to separate scales
- Consistency and/or renormalization group equations to resum dependence on scale ratios
- In IR-regulated calculations, scales can be set to zero. The universality of anomalous dimensions connects physical to formal calculations, and to other theories
- Classic example is the Drell-Yan pair Q_T :

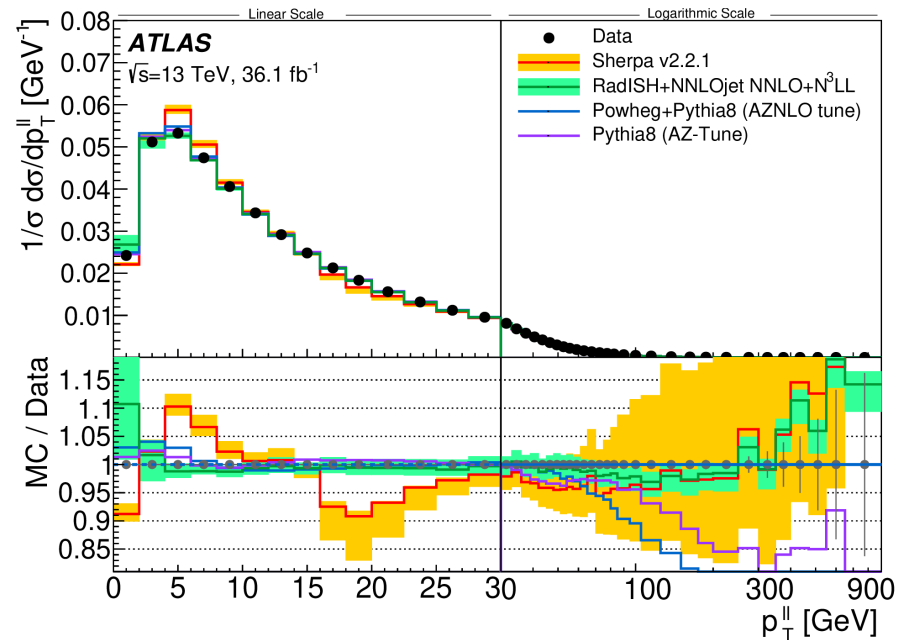

(Z. Wu for ATLAS (2022))

- A bit more, to get an example ...

- Drell-Yan Q_T (Dokshitzer-Diakanov-Troian; Curci-Greco-Srivastava; Parisi-Petronzio, Collins-Soper, Collins-Soper-GS (1980-85)). Starts with a factorization in impact parameter space.

$$\frac{d\sigma_{NN \rightarrow QX}(Q, b)}{dQ} = \int d\xi_1 d\xi_2 H(\xi_1 p_1, \xi_2 p_2, Q, \mathbf{n})_{a\bar{a} \rightarrow Q+X} \\ \times \mathcal{P}_{a/N}(\xi_1, \mathbf{p}_1 \cdot \mathbf{n}, b) \mathcal{P}_{\bar{a}/N}(\xi_2, \mathbf{p}_2 \cdot \mathbf{n}, b) U_{a\bar{a}}(b, \mathbf{n})$$

- The cross section is independent of μ and of the vectors n^μ introduced to quantify collinearity.

$$\mu_{\text{ren}} \frac{d\sigma}{d\mu_{\text{ren}}} = 0 \quad n^\alpha \frac{d\sigma}{dn^\alpha} = 0$$

- Apply separation of variables to both equations, as in evolution ...

- The result is an inverse transform of the solutions to the two equations

$$\frac{d\sigma_{NN\text{res}}}{dQ^2 d^2\vec{Q}_T} = \sum_{\bar{a}} H_{a\bar{a}}(\alpha_s(Q^2)) \int \frac{d^2b}{(2\pi)^2} e^{i\vec{Q}_T \cdot \vec{b}} e^{E_{a\bar{a}}^{\text{PT}}(b, Q, \mu)}$$

$$\times \sum_{a=q\bar{q}} \int_{\xi_1 \xi_2} \frac{d\hat{\sigma}_{a\bar{a} \rightarrow \mu^+ \mu^- (Q) + X}}{dQ^2} f_{a/N}(\xi_1, 1/b) f_{\bar{a}/N}(\xi_2, 1/b)$$

“Sudakov” exponent links large and low virtuality:

$$E_{a\bar{a}}^{\text{PT}} = - \int_{1/b^2}^{Q^2} \frac{dk_T^2}{k_T^2} \left[2A_q(\alpha_s(k_T)) \ln \left(\frac{Q^2}{k_T^2} \right) + 2B_q(\alpha_s(k_T)) \right]$$

- The function $A(\alpha_s)$ is the “cusp” anomalous dimension, appearing a numerous other applications, for example “threshold resummations” (GS, Catani & Trentadue (1988) ...)
- Redeveloped for heavy quark production, “high energy factorization” (R.K. Ellis and J. Collins; Catani, Ciafaloni, Hautmann, NPB 1991).

5. SUMMARY AND FOR THE COMING YEARS

What changed QCD from curious to obvious

- **Lattice QCD verification of coexistence of confinement with asymptotic freedom (Creutz (1979))**
- **Fundamental degrees of freedom coming to life as jets ...**
- **Petra: gluon jet (1979); UA1, UA2: very high- p_T quark-quark scattering (1982)**

PHYSICS LETTERS

24 September 1979

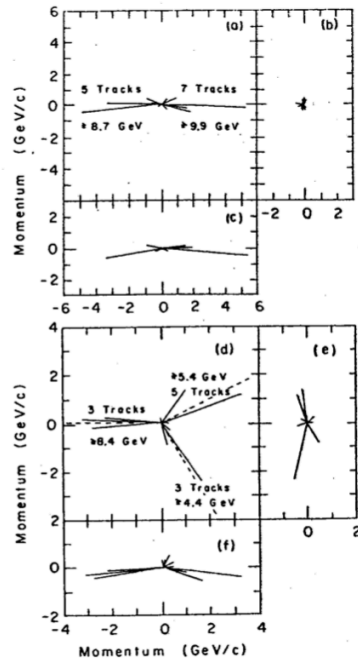

Fig. 6. Momentum space representation of a two-jet event (a)–(c) and a three-jet event (d)–(f) in each of three projections. (a), (d) $\vec{n}_2 - \vec{n}_3$ plane; (b), (e) $\vec{n}_1 - \vec{n}_2$ plane; (c), (f) $\vec{n}_1 - \vec{n}_3$ plane.

Volume 118B, number 1, 2, 3

PHYSICS LETTERS

2 December 1982

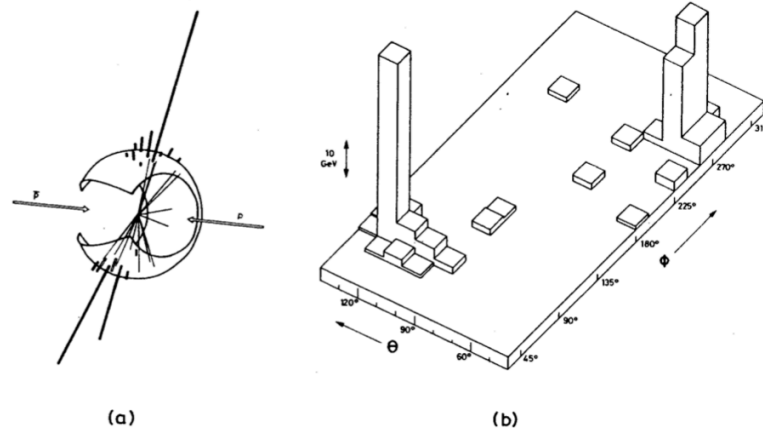

Fig. 4. Configuration of the event with the largest value of ΣE_T , 127 GeV ($M = 140$ GeV): (a) charged tracks pointing to the inner face of the central calorimeter are shown together with cell energies (indicated by heavy lines with lengths proportional to cell energies). (b) the cell energy distribution as a function of polar angle θ and azimuth ϕ .

- **At 50 years, QCD is still young.**
- **Many original issues remain: weak to strong QCD.**
 - fine jet substructure
 - footprints of color flow (new physics searches)
 - confinement for moving quanta
 - theory of hadronization
- **All scales are relevant in all accelerator experiments.**
- **New ideas are being developed to exploit them, and older concepts used in new ways (viz. energy correlations).**

- **Local unitarity, for example, should make it possible to identify bespoke weight functions for studies of final state dynamics. A general form (GS and Ani Venkata to appear 2023) in e^+e^- annihilation is:**

$$\begin{aligned}
\Sigma[f] = & \sum_G \sum_{\tau_G} \int d\mathcal{L}_G \mathbb{N}_{\tau_G} \prod_{i=1}^{N_G} \frac{1}{2\omega_i} \\
& \times \left(\prod_{s=1}^{n+1} \frac{i}{Q\lambda_s - \sum_{j \in s} \omega_j + i\epsilon} f_{n+1} \right. \\
& + \sum_{C=1}^n \prod_{s=C+1}^{n+1} \frac{i}{Q\lambda_s - \sum_{j \in s} \omega_j - i\epsilon} (f_C - f_{C+1}) \prod_{s=1}^C \frac{i}{Q\lambda_s - \sum_{j \in s} \omega_j + i\epsilon} \\
& \left. - \prod_{s=1}^{n+1} \frac{i}{Q\lambda_s - \sum_{j \in s} \omega_j - i\epsilon} f_1 \right). \tag{3.15}
\end{aligned}$$

- f_C is an infrared-safe weight function of the momenta in state C , dependent on energy flow (and possibly charge – K. Lee & I. Moutl 2023)
- **IR finite in four dimensions, and a tool to study power corrections to partial cross sections.**
- Unprecedented computational concepts and capacities are still to be exploited.
- Extraordinary experimental and theoretical developments make the dream of mapping the paths between partons and hadrons a possibility.