



A modular muon telescope for tomography and radiography applications

Abhishek¹, R. Karnam², V. K. S. Kashyap^{1,2}, B. Mohanty^{1,2}

1. School of Physical Sciences (SPS)

2. Centre for Medical and Radiation Physics (CMRP)

National Institute of Science Education and Research Bhubaneswar, An OCC of HBNI, Jatni, Khurda – 752050, Odisha, INDIA

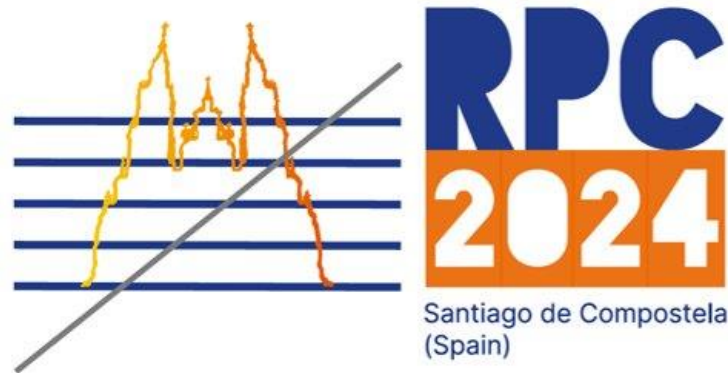

Outline

- Introduction
- Motivation
- Muon tomography simulation studies
- RPC based muon telescope developments
- Summary and conclusions

Introduction

- Muography

Muography

- When muons traverse through a given material
 - Deflect from their incident direction due elastic scattering from target nuclei
 - Loose their energy due to inelastic collisions with the atomic electrons in the target
- Muons have very high penetration capabilities through the material
- **Muography** is an imaging technique exploits the scattering and/or absorption characteristics of the atmospheric muons

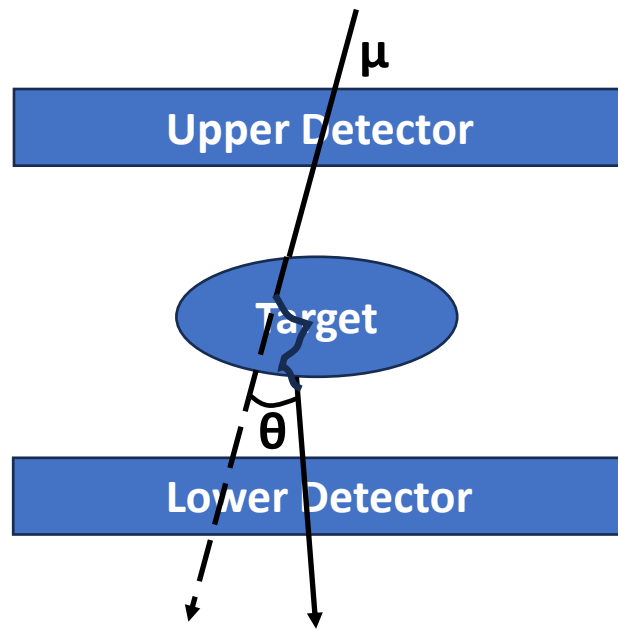

Muon tomography technique

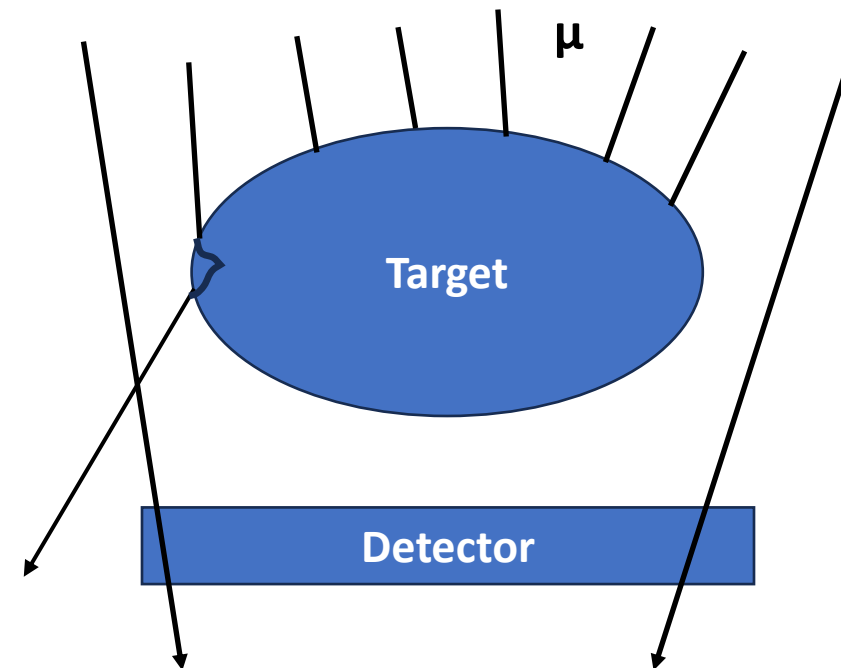

Muon radiography technique

Muography

Muon Tomography [1,2]

- When cosmic-ray muons crossing a given material, they are affected with elastic multiple coulomb scattering.
- After traversing a macroscopic amount of material, the net angular distribution features an approximately Gaussian core and the standard deviation can be expressed as:

$$\sigma(\theta) = \frac{13.6 \text{ MeV}}{\beta c p} \sqrt{\frac{x}{X_0}} \left[1 + 0.038 \ln \frac{x}{X_0 \beta^2} \right]$$

- $\frac{1}{X_0}$ can be expressed as:

$$\frac{1}{X_0} \propto \frac{Z(Z+1)}{A} \ln \left(\frac{287}{\sqrt{Z}} \right)$$

- $\sigma(\theta)$ is directly related to Z , the basis for scattering based muography.
- **Applications:** Controls of the transport for the detection of the illicit or dangerous materials, nuclear safety, etc.

Muon Radiography [1,2]

- This technique is based on measurement of the attenuation of the muon flux intensity by large massive object.
- Expected muon transmission:

$$T_E(\theta, \phi, \bar{\rho}) = \frac{\Phi_{ET}(\theta, \phi, \bar{\rho})}{\Phi_{EFS}(\theta, \phi)}$$

- Measured muon transmission:

$$T_M(\theta, \phi) = \frac{\Phi_{MT}(\theta, \phi)}{\Phi_{MFS}(\theta, \phi)}$$

- Relative transmission:

$$R(\theta, \phi, \bar{\rho}) = \frac{T_M(\theta, \phi, \bar{\rho})}{T_E(\theta, \phi)}$$

Here, θ is zenith angle, ϕ is azimuthal angle, Φ is differential flux.

- **Applications:** Railway tunnel investigations

[1] *Prog. Part. and Nucl. Phys.* 112 (2020) 103768

[2] *Rev. in Phys.* 5 (2020) 100038

Motivation

- To use the glass RPCs for muography technology

Glass RPC for muography applications

- Resistive plate chambers (RPC) are simpler to construct
- Cost-effective
- Large area ($> 10 \text{ m}^2$) RPCs can be built [3]
- Efficiency: $\geq 95\%$ at the operating voltage
- The achieved position resolutions in muography experiments: a few mm [4]
- Time resolution: $\ll 1 \text{ ns}$ [5]

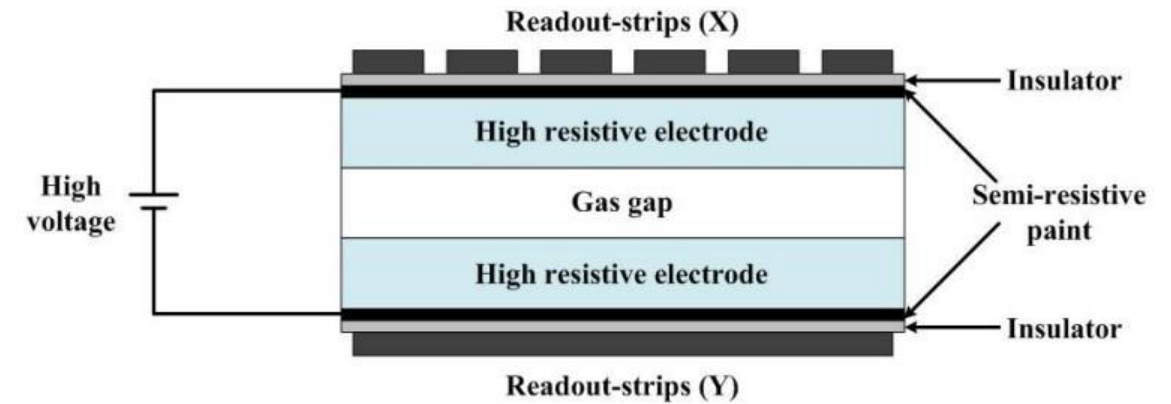

Schematic of a single gap Resistive Plate Chamber

These characteristics motivate to use the RPCs for muon tomography/radiography applications

[3] *Rev. in Phys.* 5 (2020) 100038

[4] J. Bonnard et al, *High performance electronics for a muon telescope operating in an isolated site, DIRE collaboration, Muographers2022 workshop*

[5] *IEEE Trans. Nucl. Sci.*, 49 (2002) 881-887

Muon tomography and radiography setups at NISER

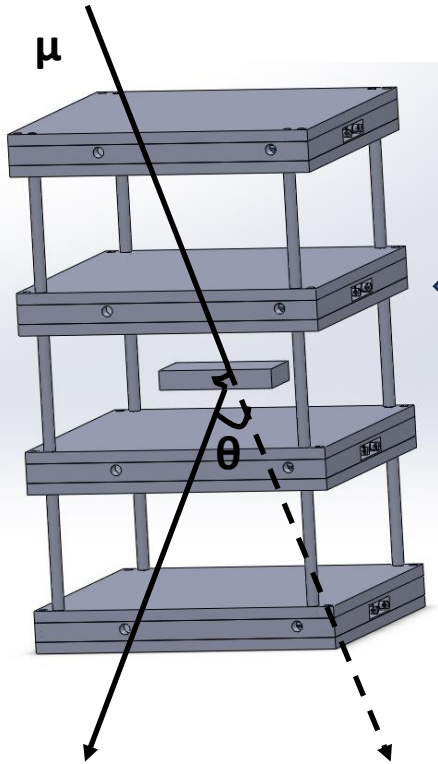

We are developing the muon telescopes in modular form for both tomography and radiography applications

This telescope has an upper and lower trackers, each comprise of two RPCs

This telescope has four layers of RPCs to track the cosmic-ray muons

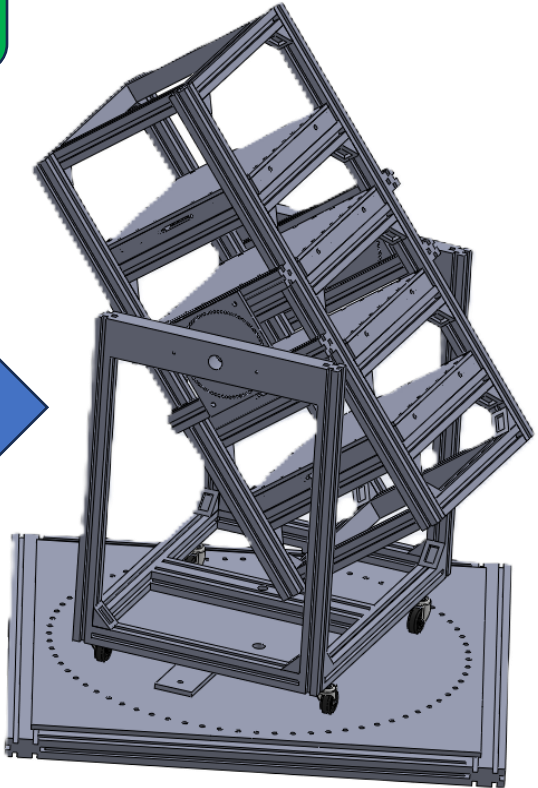

Layout of the muon telescope for the tomography activities

- Acrylic chamber outer dimensions: $400 \times 400 \text{ mm}^2$
- RPC dimensions = $200 \times 200 \text{ mm}^2$
- Readout strips = 9 mm width, 1 mm gap between consecutive strips

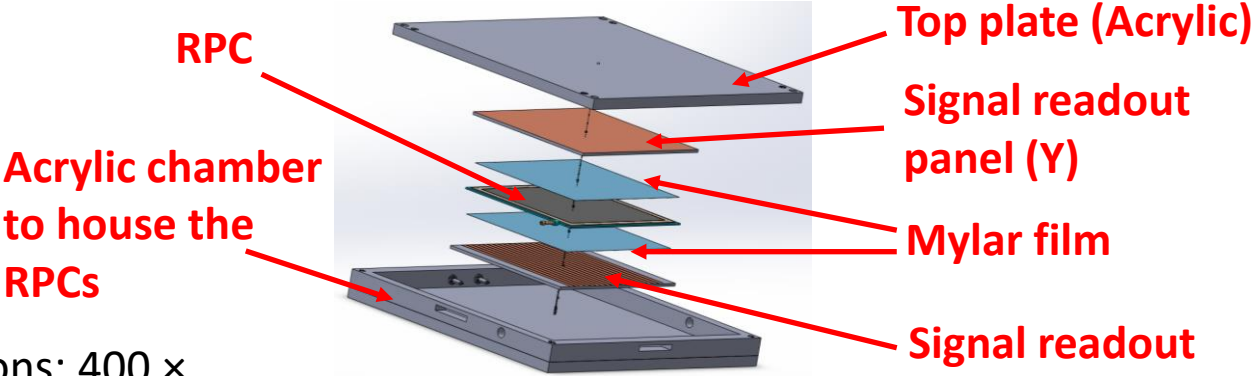

An exploded view of RPC housed in an acrylic chamber

Layout of the muon telescope for the radiography activities

Muon tomography simulation studies

Goals of the studies:

- To image the high-Z materials using the cosmic-ray muon tomography technique
- Test the technique for an application

Pipeline of the simulations work

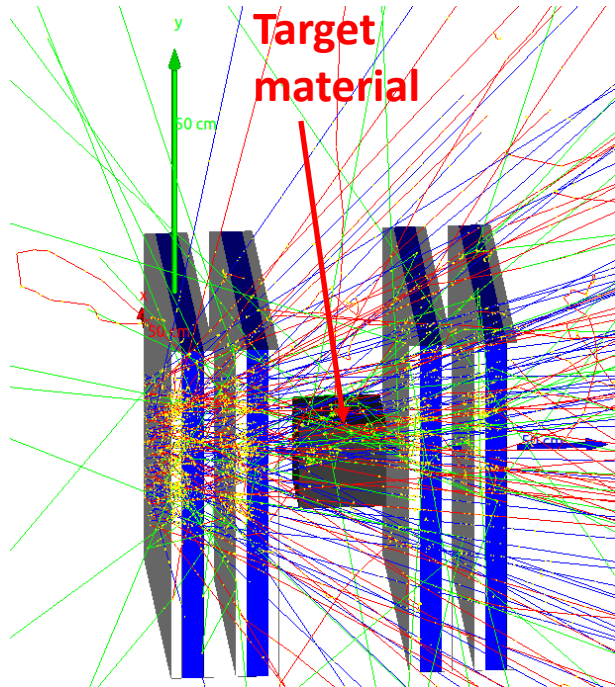
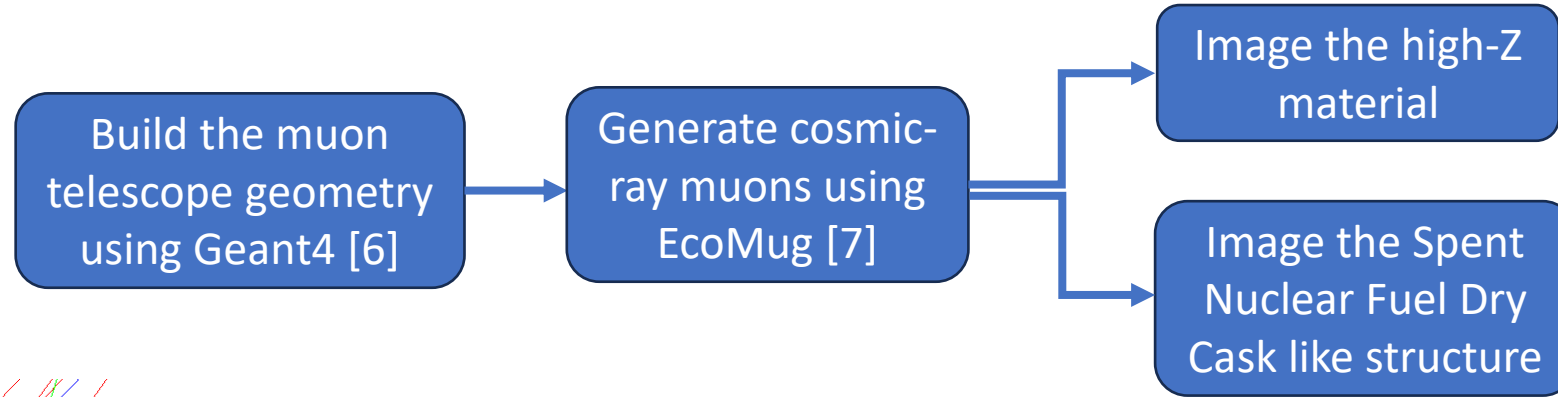

Geant4 geometry of the muon telescope

- A muon telescope is developed with an upper and a lower tracker
- Each tracker has two RPC modules
- A Lead block of $100 \times 100 \times 100 \text{ mm}^3$ is placed between the two trackers

[6] <https://geant4.web.cern.ch/>

[7] Nucl. Instrum. Methods Phys. Res. 1014 (2021) 165732

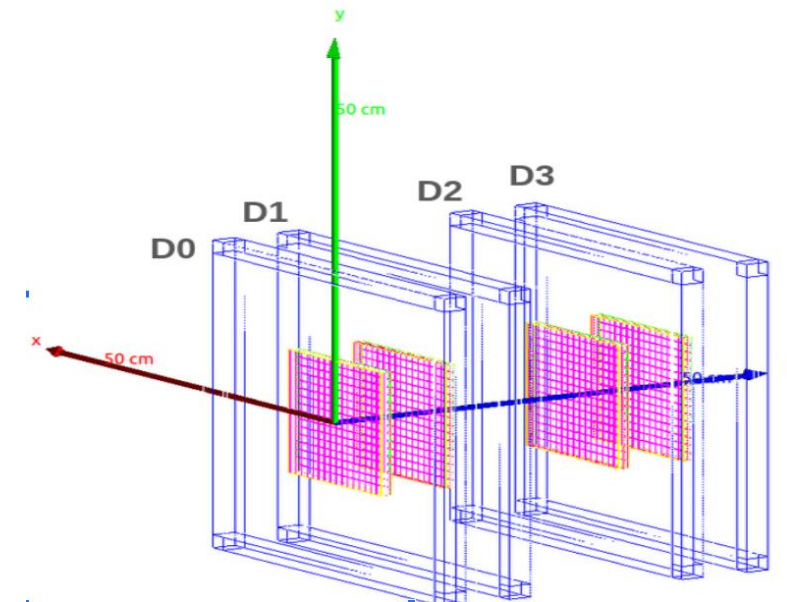

Geometry in the wired form

PoCA algorithm to image the materials [8]

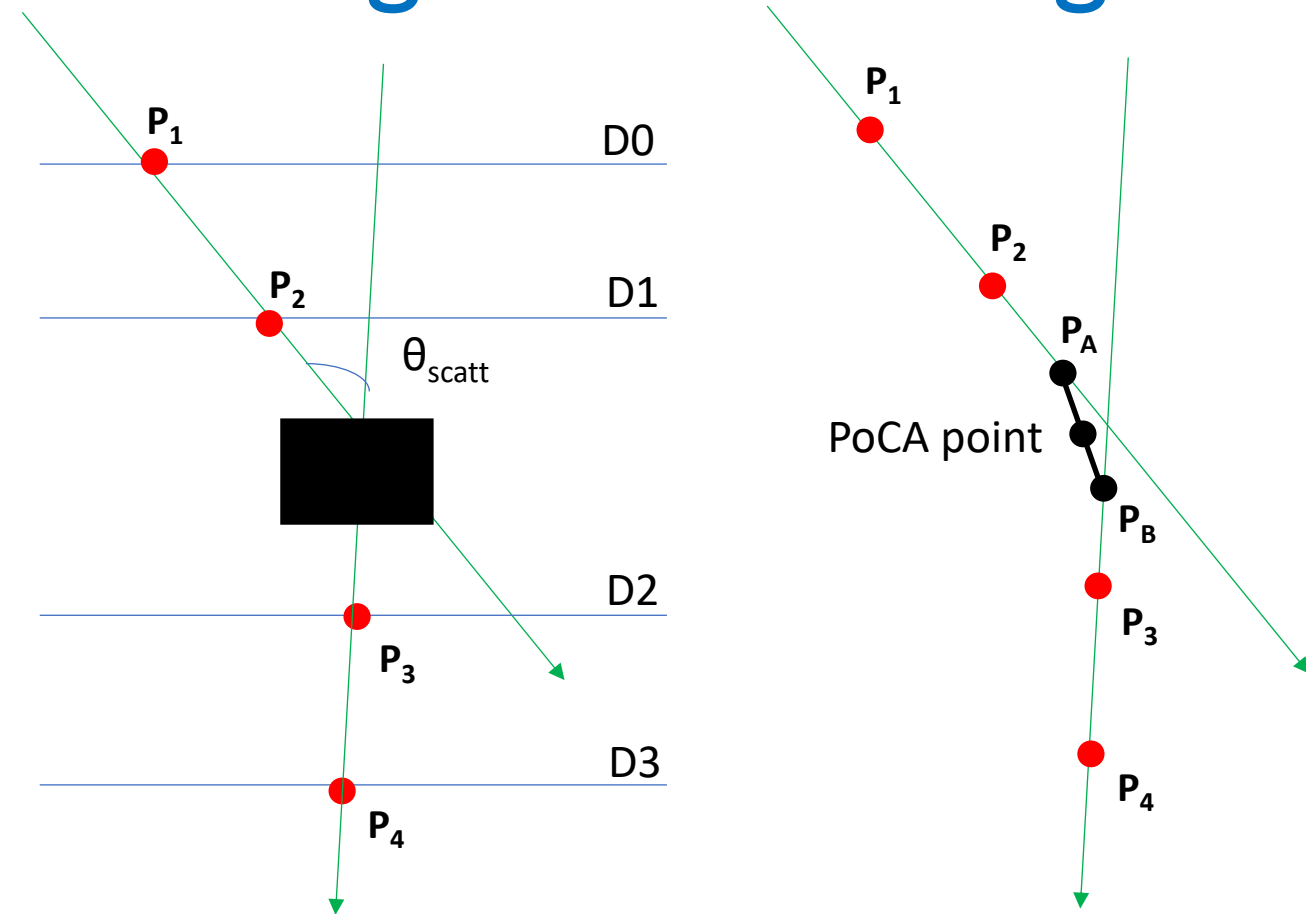

Lead block
dimensions

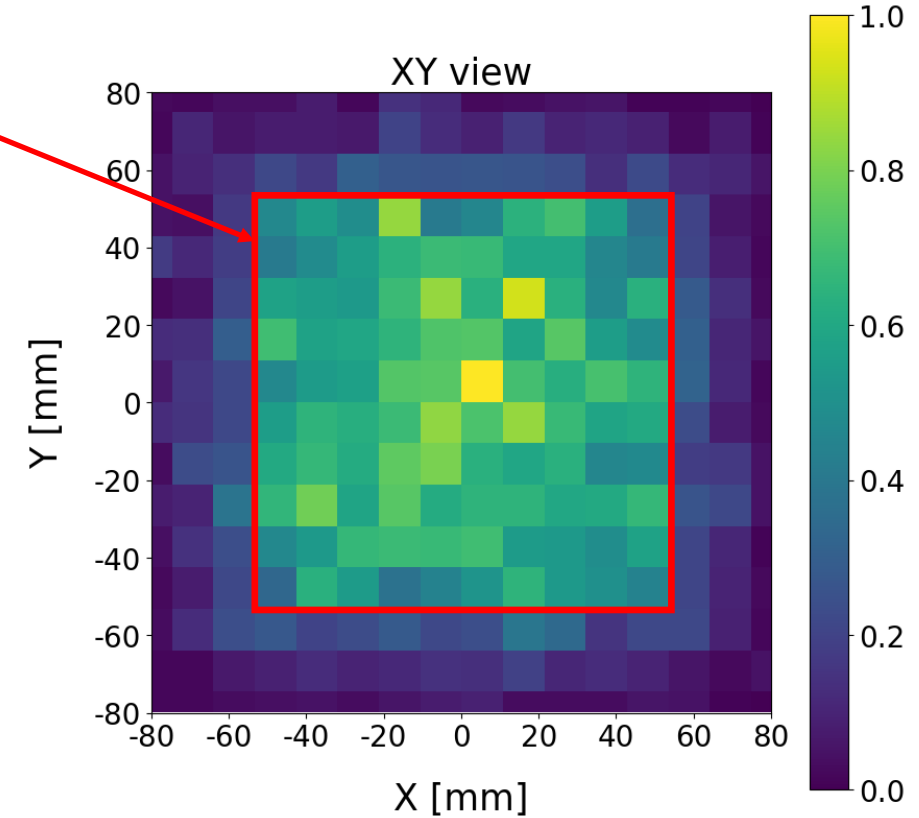

PoCA image of the Lead block (Z=82) with dimensions $100 \times 100 \times 100 \text{ mm}^3$ placed between the upper and lower trackers (From simulation studies)

- For a muon event, reconstruct the muon tracks from the upper and lower trackers
- Find the minimum distance between the two tracks
- Point of Closest Approach (PoCA) point is the mid point of line joining P_A and P_B

[8] Nucl. Instrum. Methods Phys. Res. 1014 (2021) 165732

High and Medium-Z material discrimination

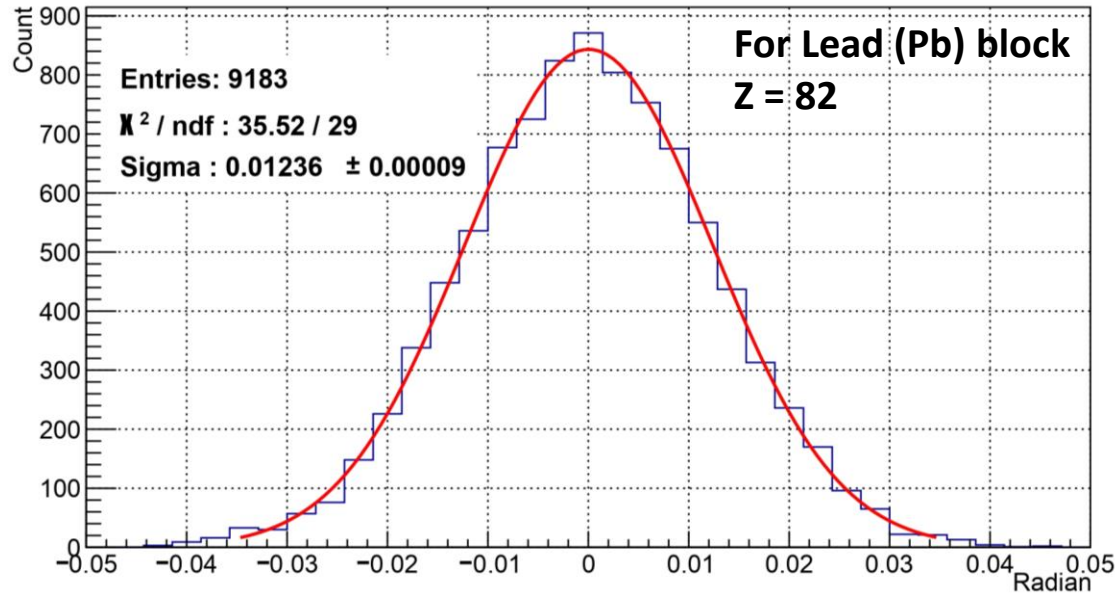

Scattering angle distribution for Lead (Pb) block of size $100 \times 100 \times 100 \text{ mm}^3$

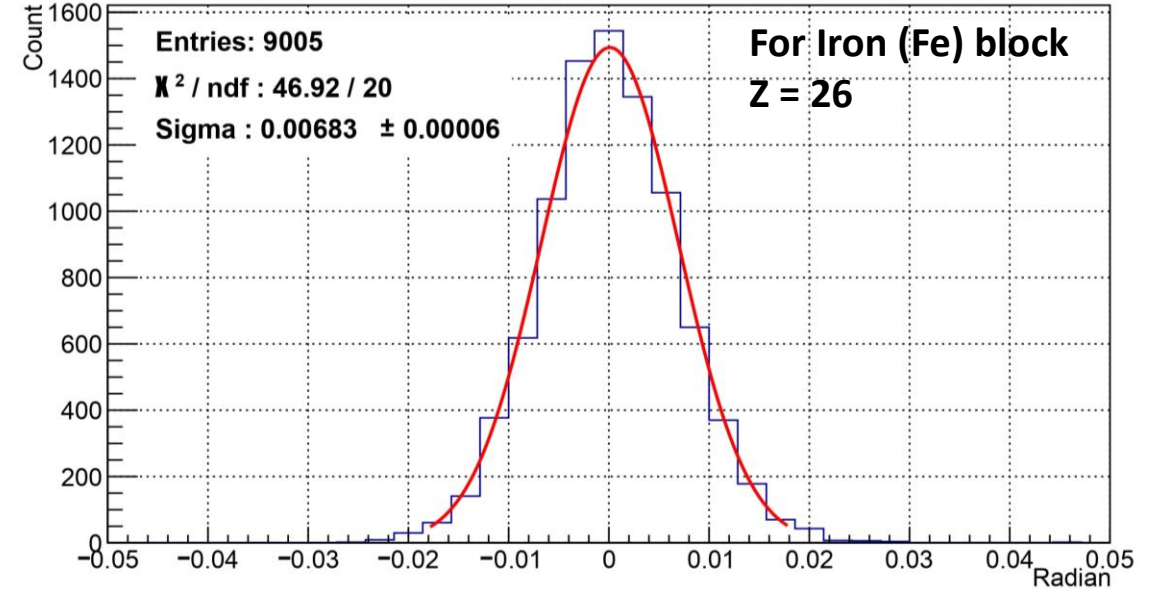

Scattering angle distribution for Iron (Fe) block of size $100 \times 100 \times 100 \text{ mm}^3$

Material (Z)	$\sigma_{\text{Theoretical}}$ (mrad)	$\sigma_{\text{Simulation}}$ (mrad)
Lead	12.05	12.31
Iron	6.65	6.77

Larger σ (width of the distribution) observed for larger-Z material

Binned Clustering Algorithm (BCA) [9]

- The 3D space between the two inner detectors D1 and D2 is divided into the voxels of the size $10 \times 10 \times 10 \text{ mm}^3$
- The PoCA points and the corresponding scattering angles are stored in each voxel
- For every pair of muon tracks with scatter vertices $v_i(x_i, y_i, z_i)$ and $v_j(x_j, y_j, z_j)$ located within the same voxel, calculate the metric distance $m_{ij} = \|v_i - v_j\|$
- The metric distance is weighted with the scattering angles as $\tilde{m}_{ij} = \frac{m_{ij}}{\theta_i \cdot \theta_j}$
- Score = Median($\ln(\tilde{m}_{ij})$)

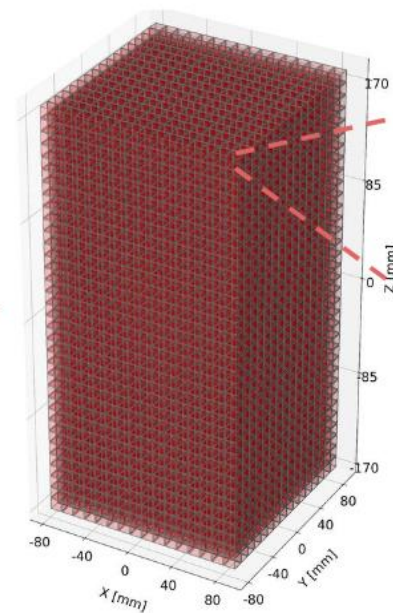
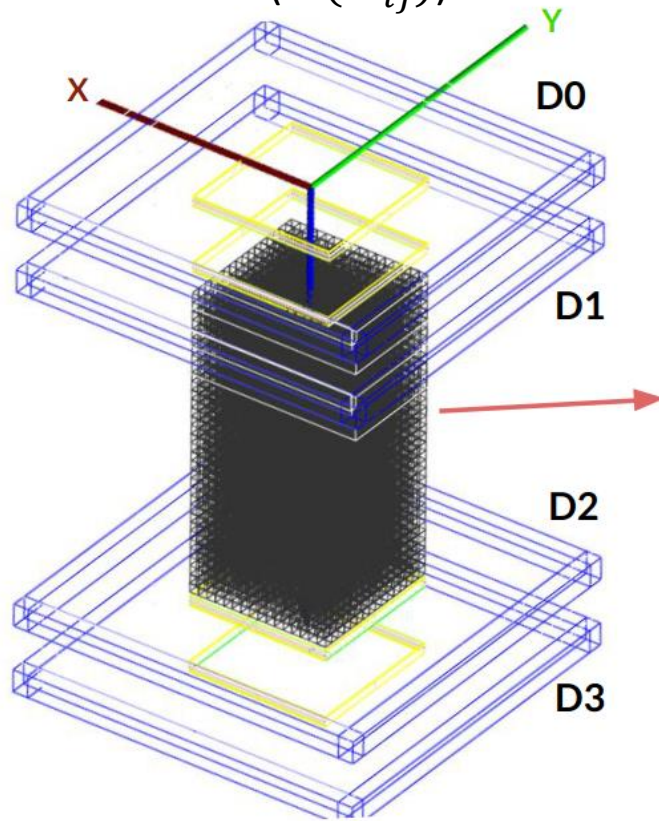

(1) Median($\ln(M_{ij})$): 0.78

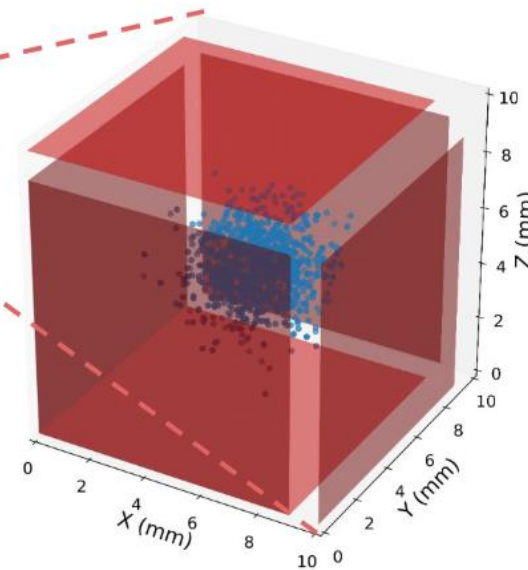

(2) Median($\ln(M_{ij})$): 1.89

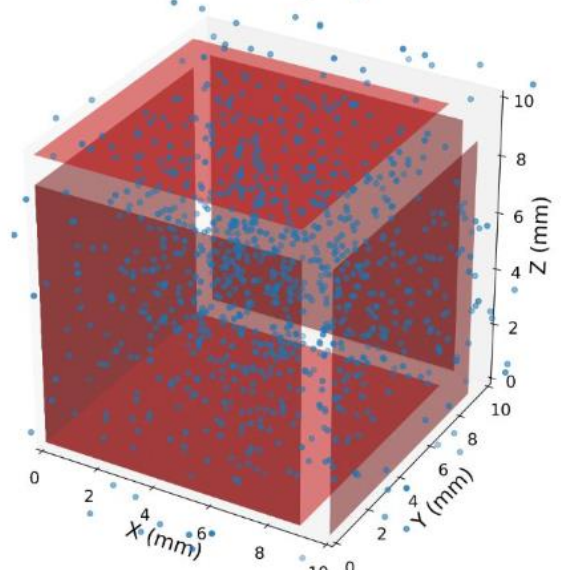

[9] JINST 8 (2013) P10013

Imaging with Binned Clustering Algorithm (BCA)

- With PoCA algorithm, false PoCA points are recorded outside the Lead block. These false points are from the muon scattering in the acrylic material.
- This issue is resolved using Binned Clustering Algorithm (BCA).

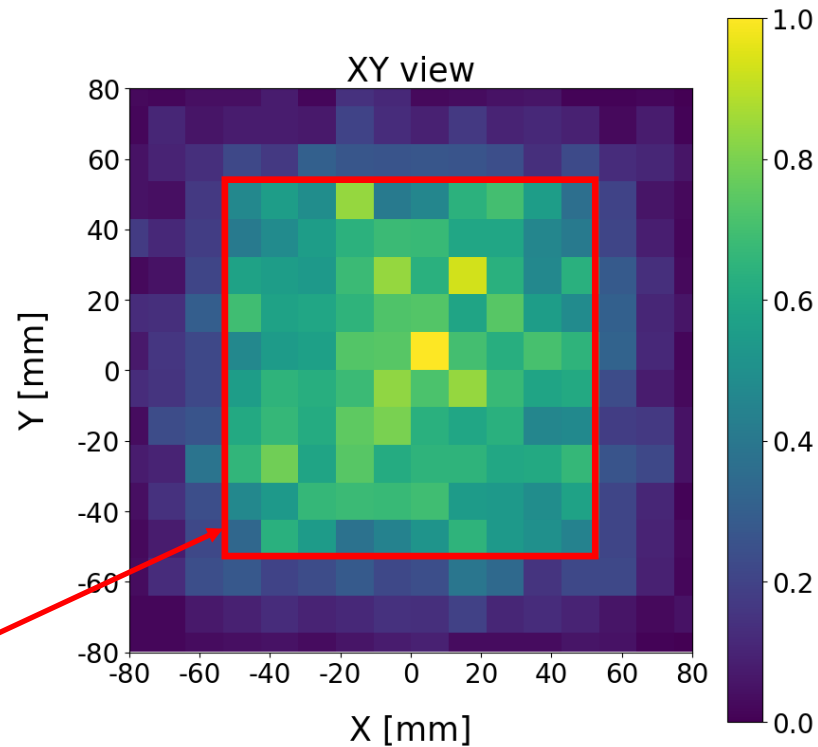

PoCA image of the Lead block of size $100 \times 100 \times 100 \text{ mm}^3$

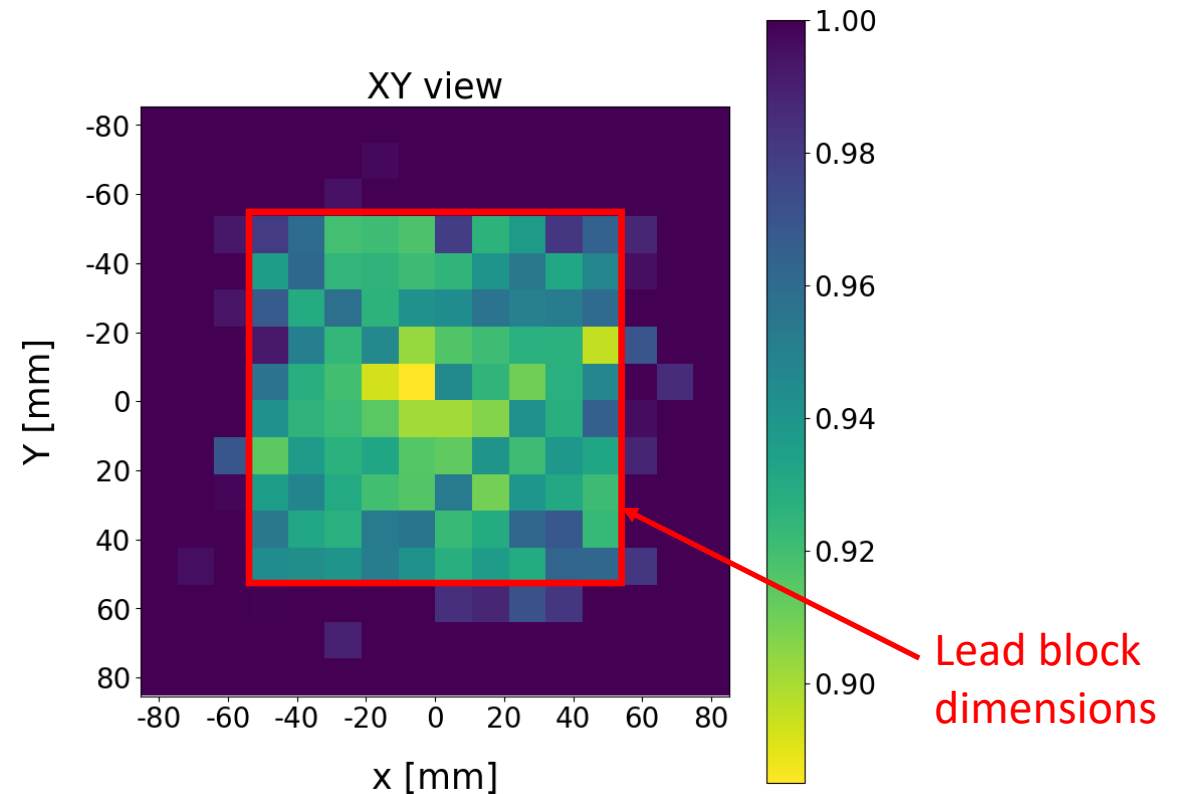

BCA image of the Lead block of size $100 \times 100 \times 100 \text{ mm}^3$

- **The edges of the Lead block are reconstructed better with BCA compared to PoCA**

Imaging spent nuclear fuel dry cask with BCA [10]

- Spent nuclear fuel (SNF) is leftover radioactive material (U^{238}) from nuclear reactors
- It is housed in a dry cask constructed from concrete and steel
- Muon scattering tomography technique can be used for monitoring these casks.

SNF storage dry cask like structure is built using Geant4 with the following components:

Component	Dimensions	Density (g/cm ³)
Concrete shell	Outer radius = 100 mm; Inner radius = 70 mm; Height = 110 mm	2.4
Steel container	Outer radius = 70 mm; Inner radius = 65 mm, Height = 100 mm	7.8
Uranium rods	20 rods; Each rod = 10 × 10 × 100 mm ³	19.1
Copper rods	4 rods; Each rod = 10 × 10 × 100 mm ³	8.9

[10] [arXiv:1808.07534v1](https://arxiv.org/abs/1808.07534v1)

Imaging Spent Nuclear Fuel dry cask with BCA

- The dry cask is placed between the upper and lower trackers and BCA is used to reconstruct its image.

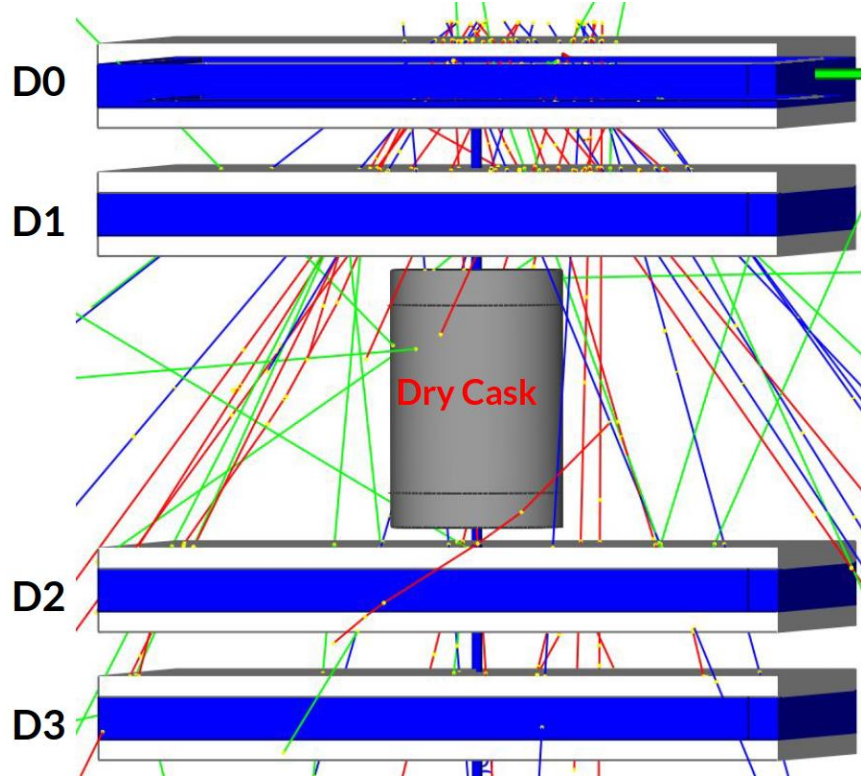

Spent nuclear fuel dry cask placed in between the upper and lower trackers

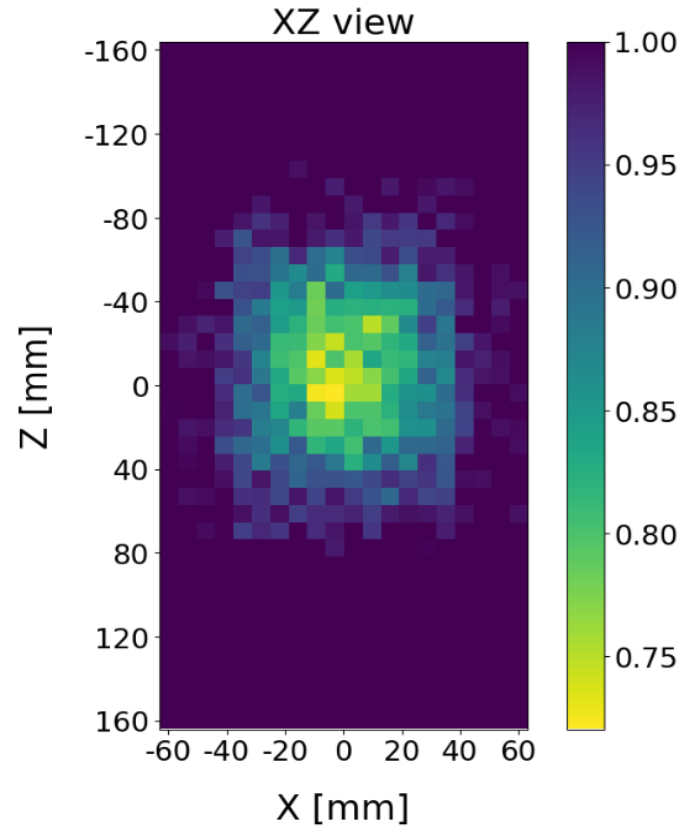

The XZ projection of the dry cask using BCA reconstruction

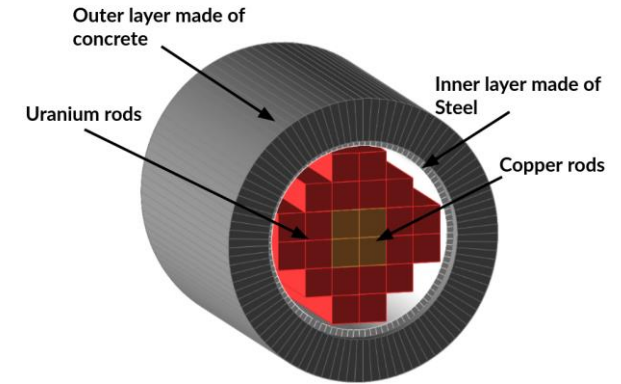

The top view of the dry cask containing the Uranium and Copper rods

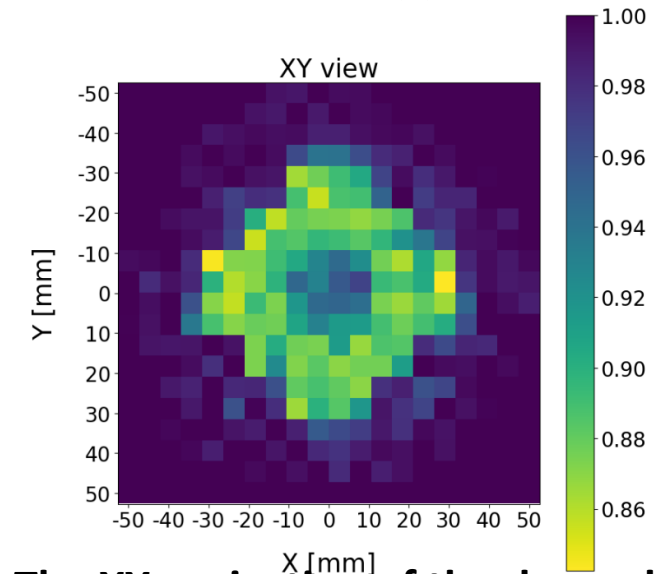

The XY projection of the dry cask using BCA reconstruction

RPC based muon telescope developments

- Four glass RPCs are built and four acrylic chambers are developed
- Efficiency and time resolutions are studied for one RPC
- Relative Humidity (RH) and temperature studies are performed to an acrylic chamber

Resistive plate chambers and readouts

- Glass RPCs are built with 3 mm thick and $200 \times 200 \text{ mm}^2$ size electrodes
- PCB readout boards are developed to study the cosmic-ray muon signals detected by the RPCs
- The efficiency and time resolution of one RPC are studied using a muon telescope developed with plastic scintillator detectors

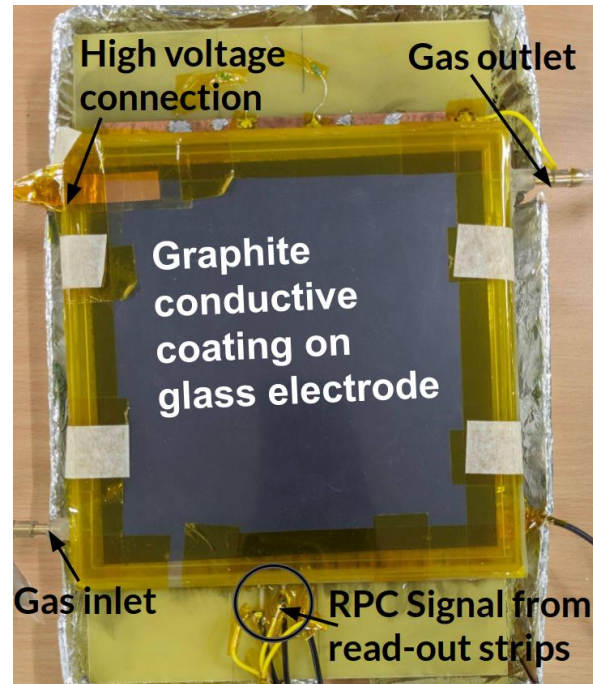

A glass RPC of $160 \times 160 \text{ mm}^2$ active area



A PCB based readout panel

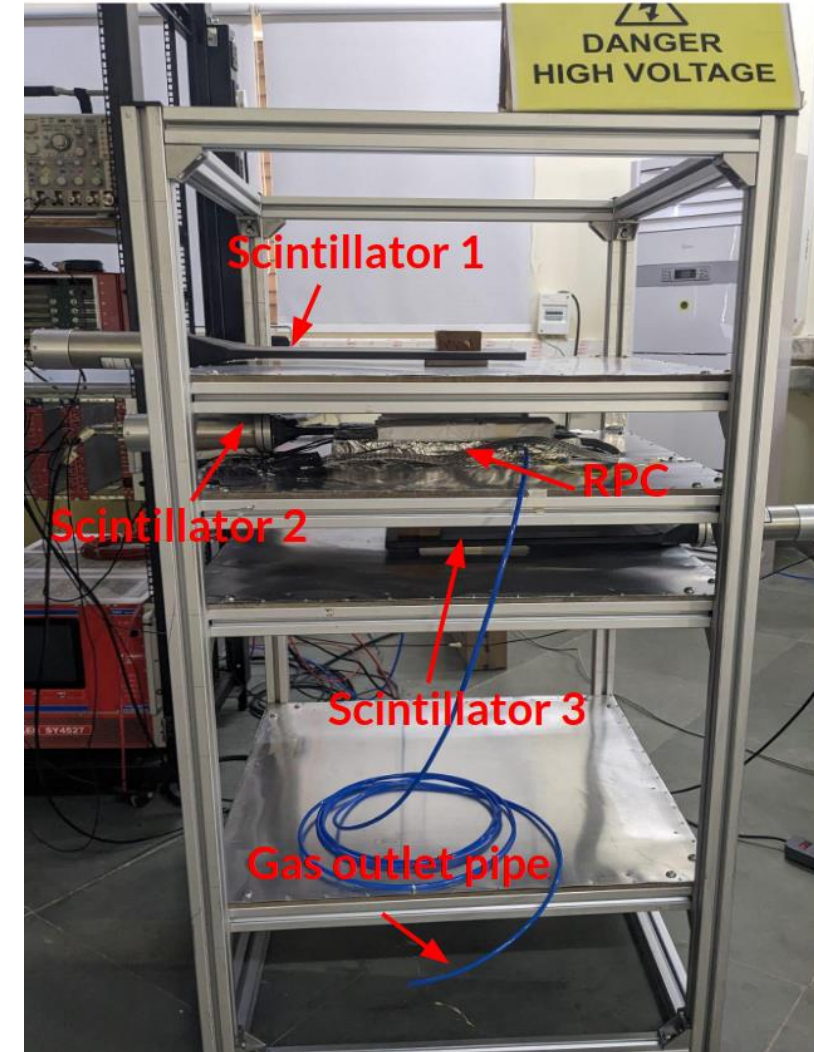

A muon telescope developed using plastic scintillator detectors

RPC Efficiency

- The efficiency of RPC is measured using a muon coincidence unit made of plastic scintillator detectors

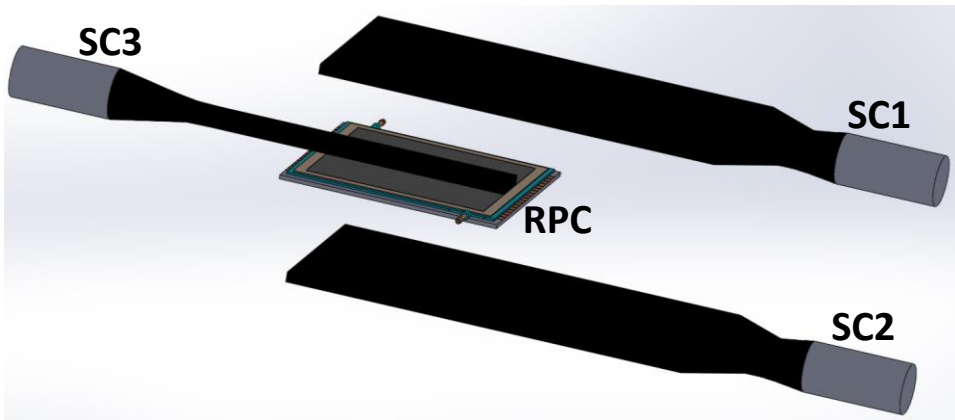

$$\text{Efficiency} = \frac{\text{Counts (SC1.SC2.SC3.RPC)}}{\text{Counts (SC1.Sc2.SC3)}}$$

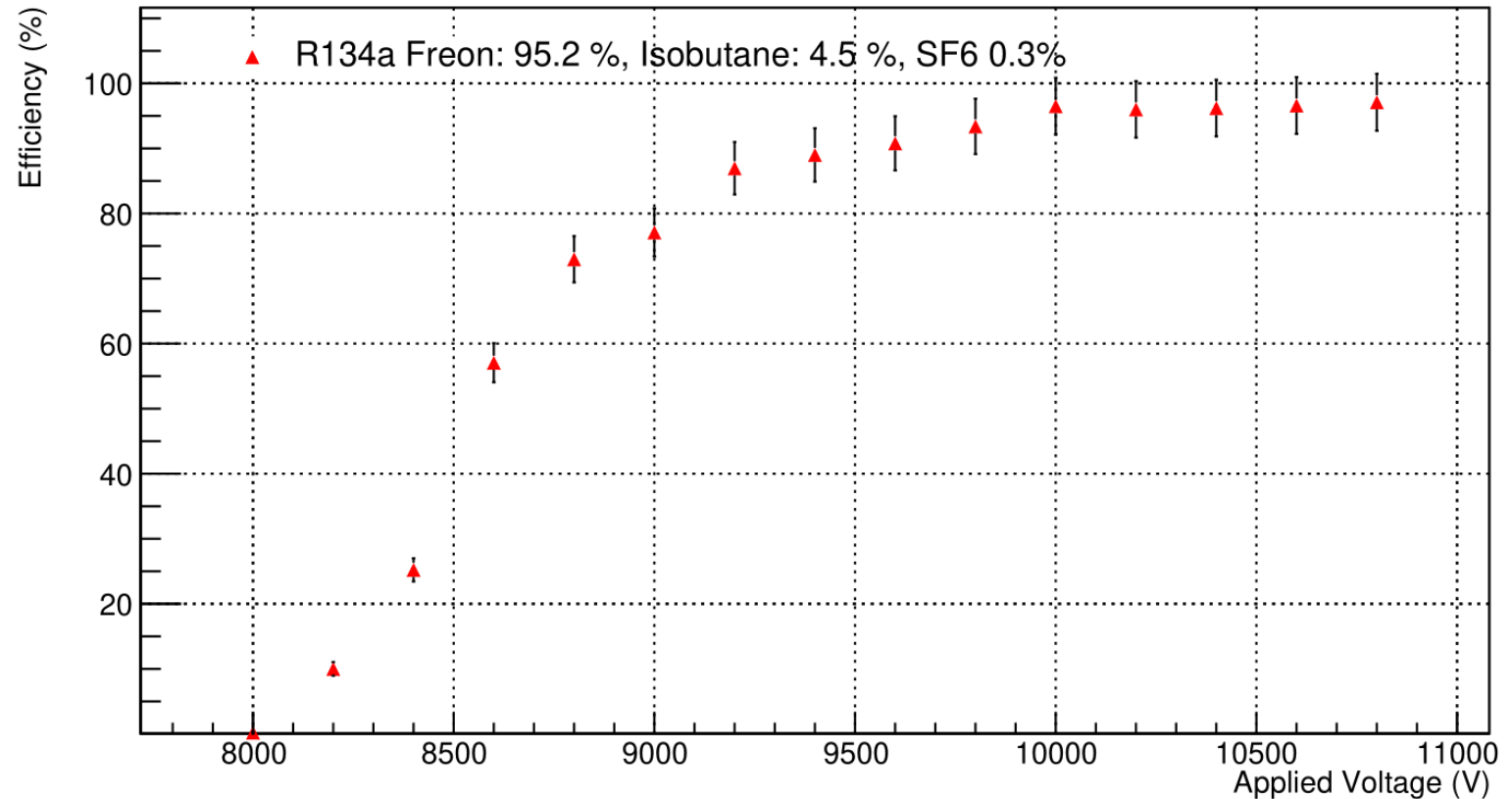

- The efficiency of RPC is **95%** on the plateau

RPC time resolution

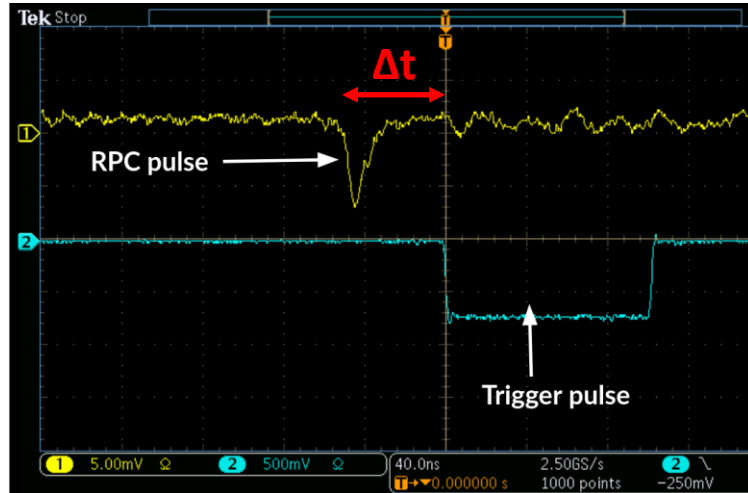

- Δt = The time difference between arrival time of RPC pulse and trigger pulse
- Δt s are plotted for the collected cosmic-ray muon events
- Gaussian function is used to fit the distribution
- Time resolution is the standard deviation (sigma) from the fit

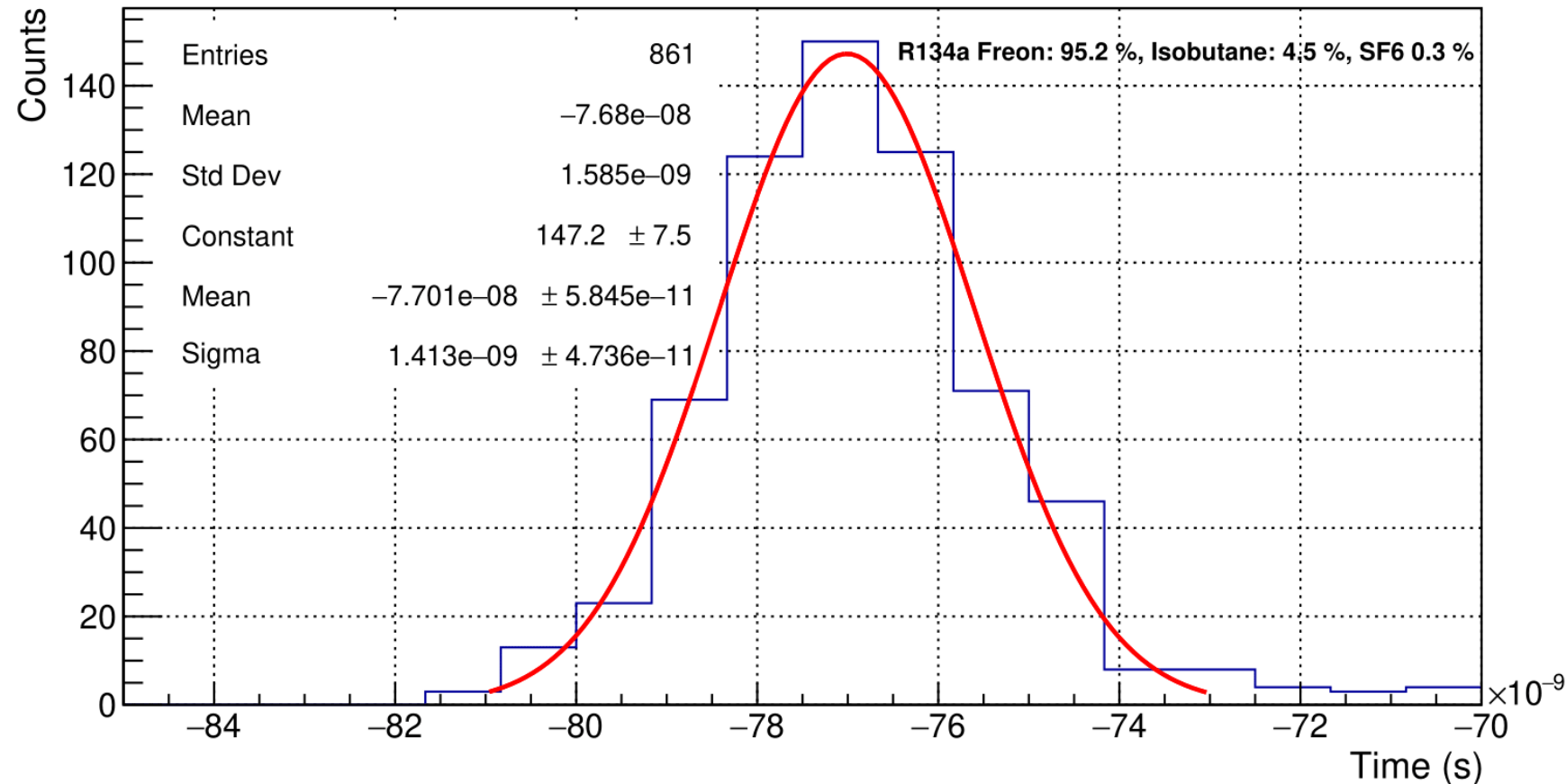

- The time resolution of RPC is **1.4 ns**

DAQ and power supply

- ASIC (PETIROC) and FPGA based DAQ system is being tested to study the RPC signals
- Single channel portable power supply module will be used to power all four RPCs

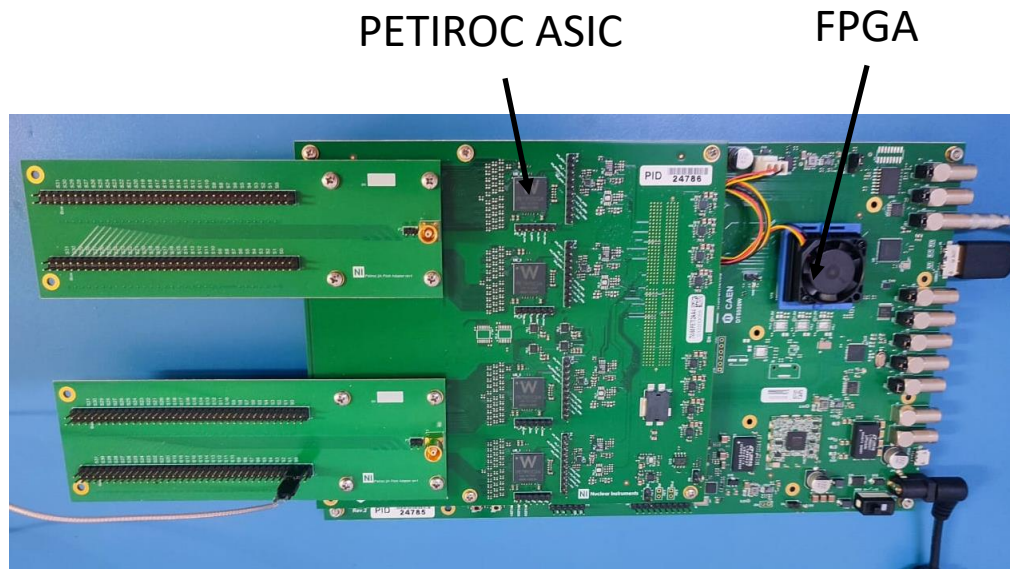

DT5550W DAQ System

PETIROC ASIC:

- Input channels: 32 inputs
(Four ASICs have 128 inputs)
- Signal polarity: positive or negative
- Dynamic range: 160 fC up to 480 pC
- 32 trigger outputs
- 40 ps bin TDC

CAEN A7512DN single channel power supply module:

- Single output channel
- The maximum output voltage = 12 kV
 - 200 mV monitor resolution
- The maximum current = 20 μ A
 - 500 pA monitor resolution



CAEN A7512DN

RH&T tests to the acrylic chamber

- RPC performance depends on the ambient Relative Humidity (RH) [11].
- Acrylic chambers are developed to house the RPCs and readout panels
- RH and Temperature (T) are monitored for 30 days inside and outside of an acrylic chamber

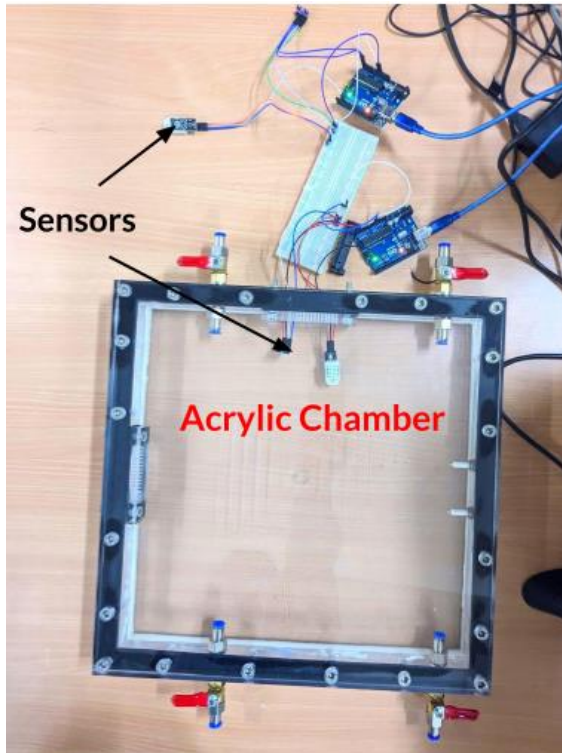

Acrylic chamber developed to house the RPC and signal readout panels

- DHT22 sensors are used to measure the temperature and RH.
- One sensor is placed inside the chamber and one outside.
- Arduino UNO R3 board is used to read the data from the sensors.
- RH variation inside the chamber is small whereas it is large outside the chamber
- Same variation of temperature is observed inside and outside the chamber

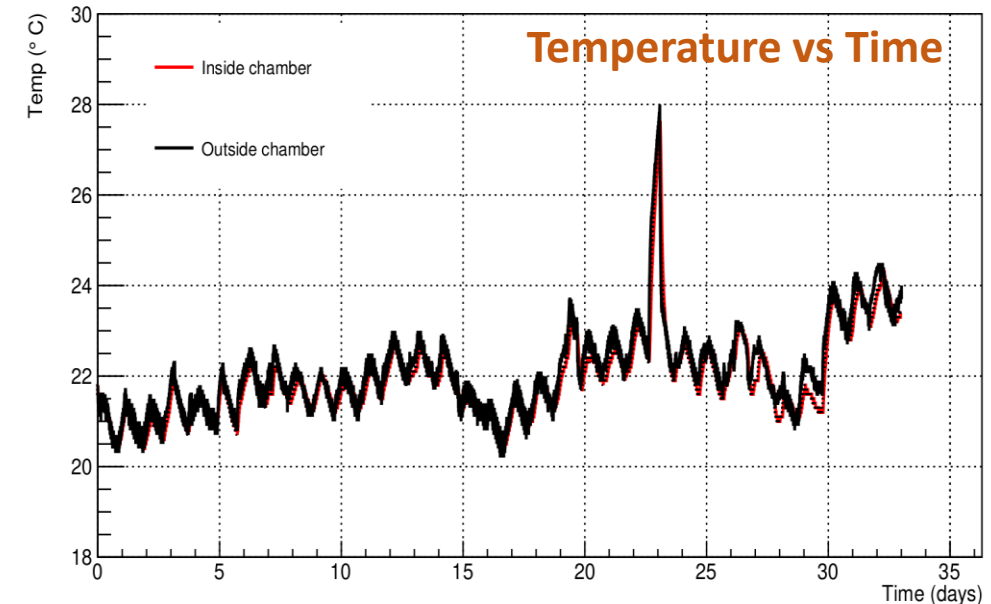
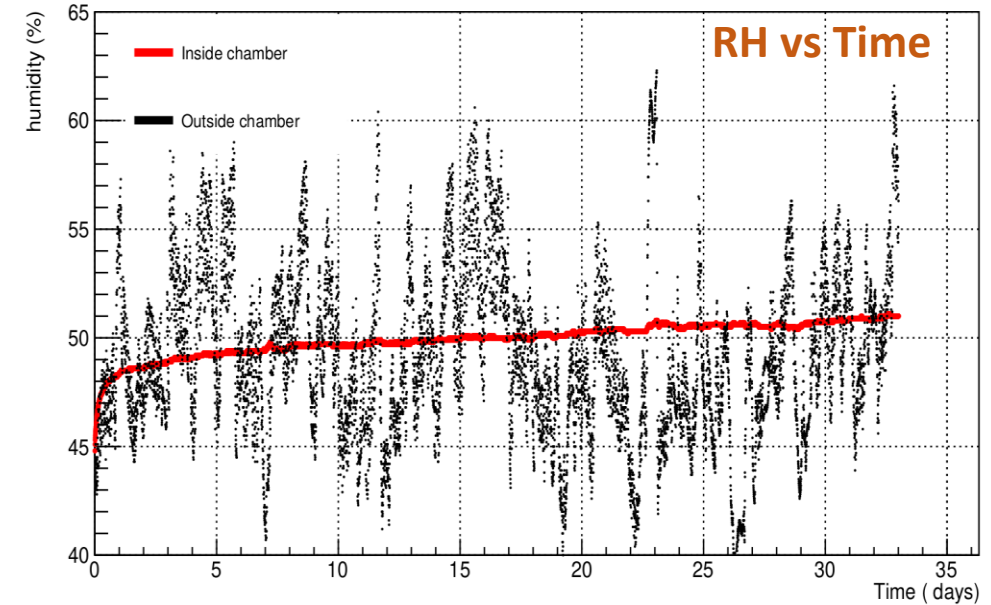

Summary and conclusions

- Simulated a glass RPC based telescope for cosmic-ray muon tomography applications using Geant4 toolkit
- Image of a Lead block is reconstructed using PoCA and BCA algorithms. BCA is found to work better
- Simulation studies demonstrate that the designed muon telescope can distinguish medium and high-Z materials
- BCA algorithm is used to image the Spent Nuclear Fuel Dry Cask like structure with the simulated muon telescope
- Efficiency of the glass RPC is 95% to detect the cosmic-ray muons and the time resolution is 1.4 ns.
- Four acrylic chambers are developed to house the RPCs and readout panels. RH and T studies are made to one chamber. RH is well controlled inside the chamber. Temperature variation is same inside and outside the chamber. These tests are being conducted for other three RPCs and acrylic chambers.

Future plans

- Construct the telescopes for both tomography and radiography applications
- Implement the ASIC (PETIROC) and FPGA based DAQ system for cosmic-ray muon data analysis from the telescope
- Test the telescope for imaging the tomography and radiography of the targets

Acknowledgements

- The authors are thankful to Department of Atomic Energy (DAE) and Department of Science and Technology (DST), India for funding this project.
- We thank D. Kumar and D. Barik of CMRP, NISER Bhubaneswar for technical help during the detector development and tests.
- We thank M. Moussawi, M. Lagrange, S. Basnet, A. Giammanco and E. Cortina Gil of UCLouvain, Belgium, for useful discussions.

Thank you

Backup slides

EcoMug Generator

Cosmic Muons Energy Distribution

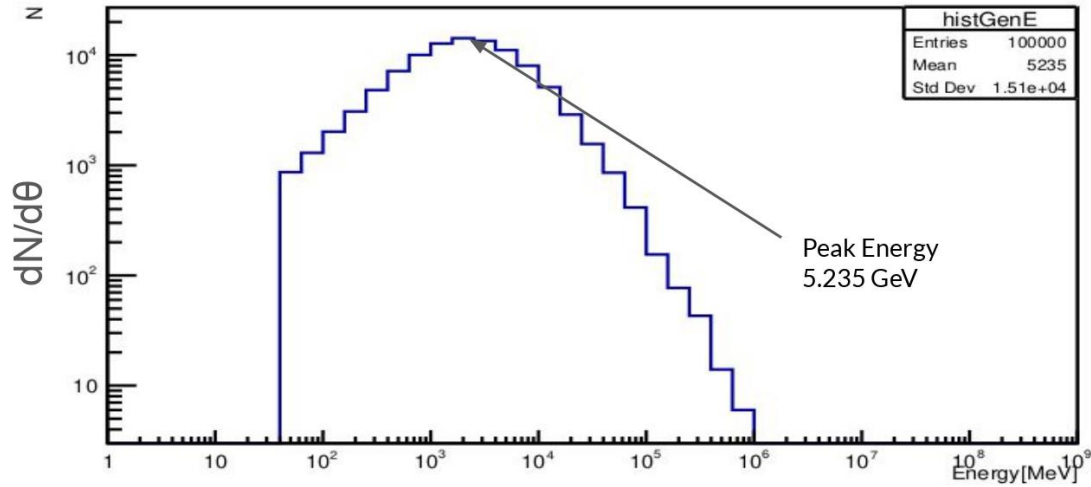

Cosmic Muons Theta(Zenith) Distribution

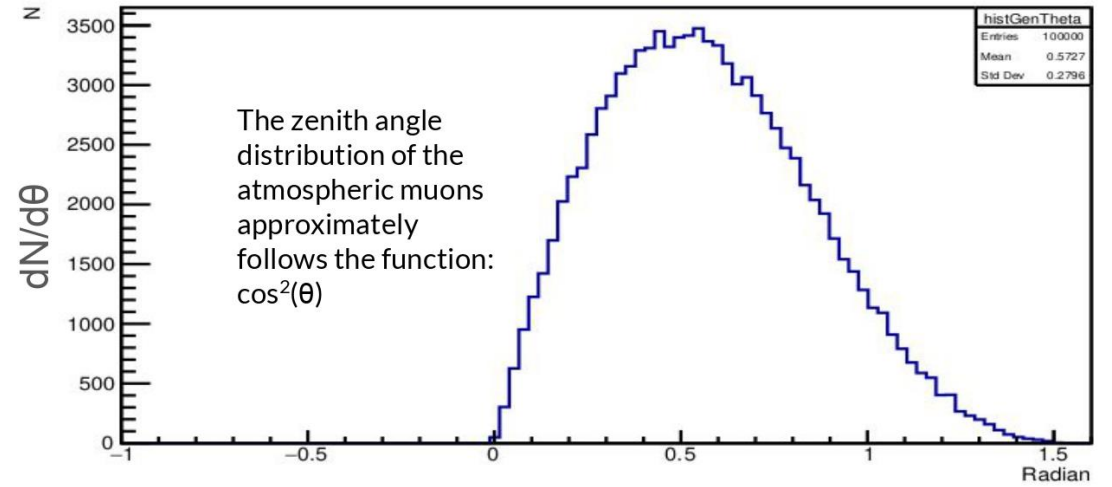

Cosmic Muons Phi(Azimuthal) Distribution

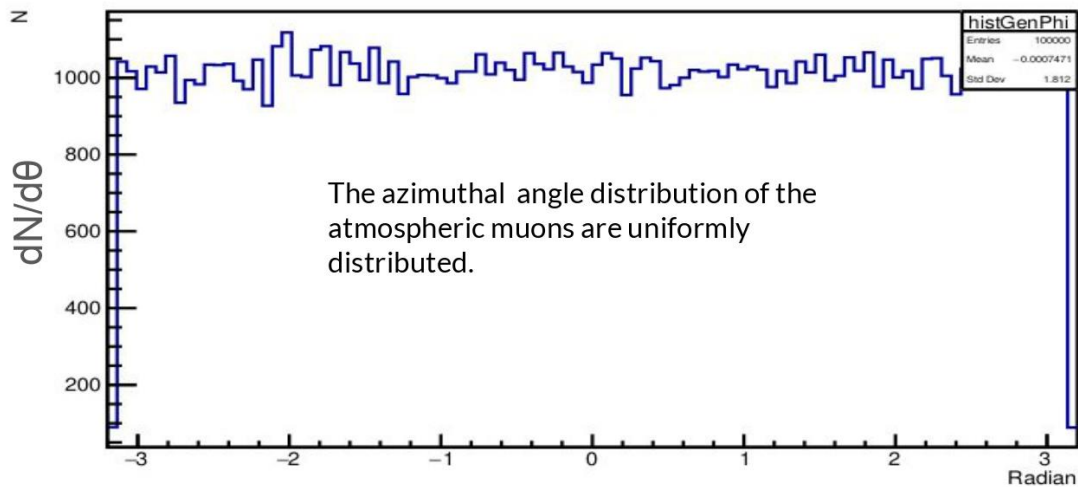

PDGid

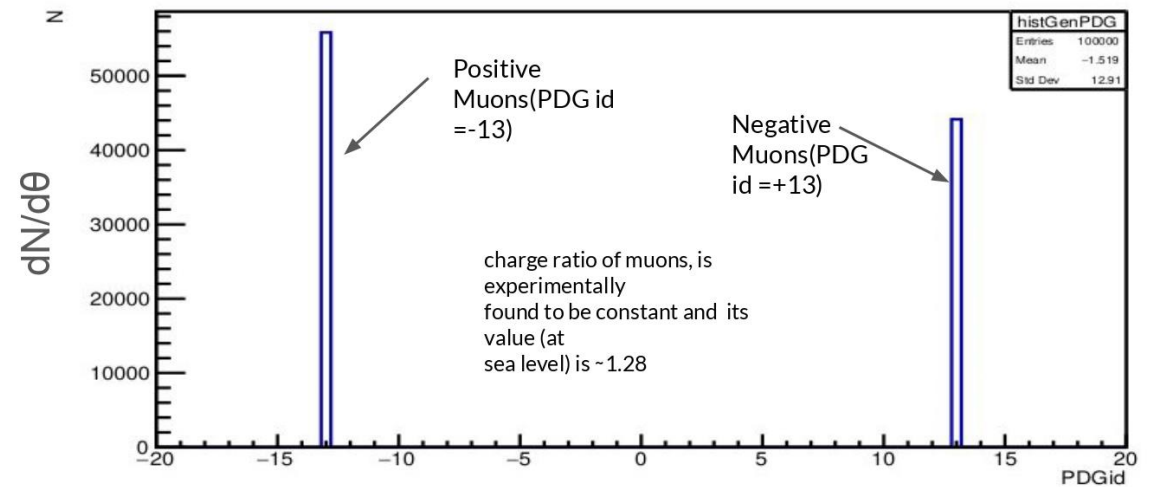

Telescope acceptance

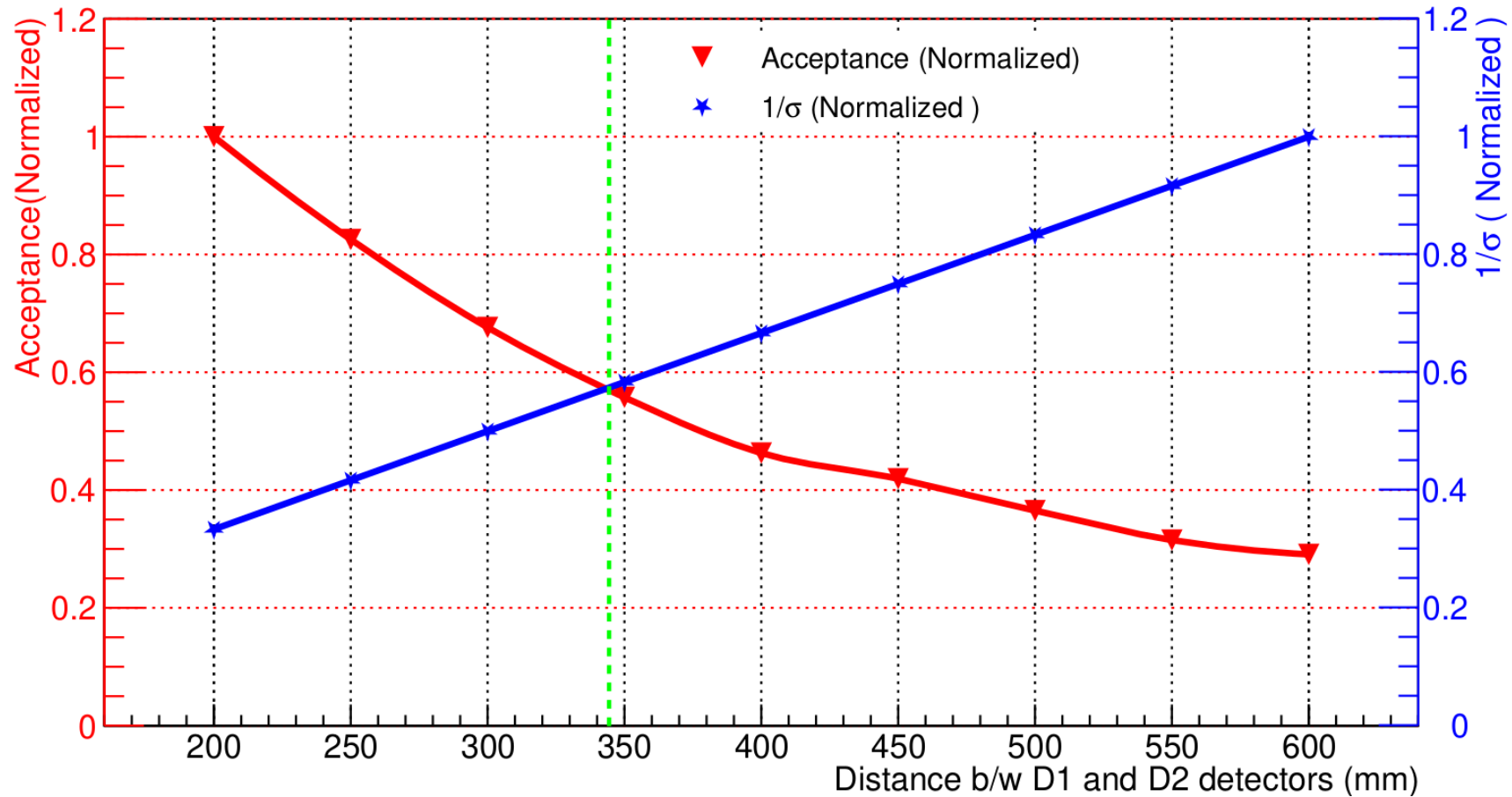

Detector developments

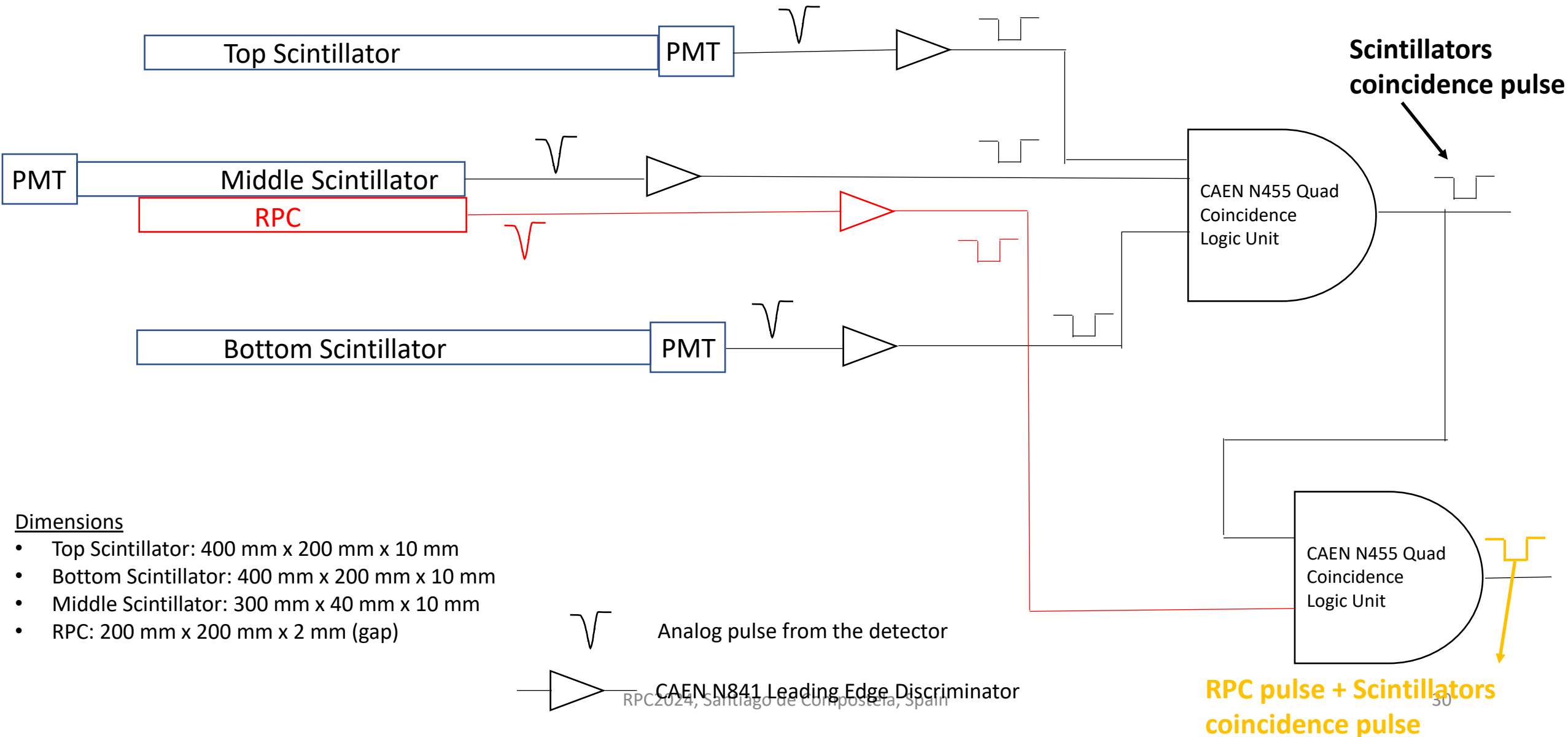

Current-Voltage (IV) characteristics of RPC

