

Centro de Microanálisis de Materiales

Introduction to the ion accelerator

Accelerator

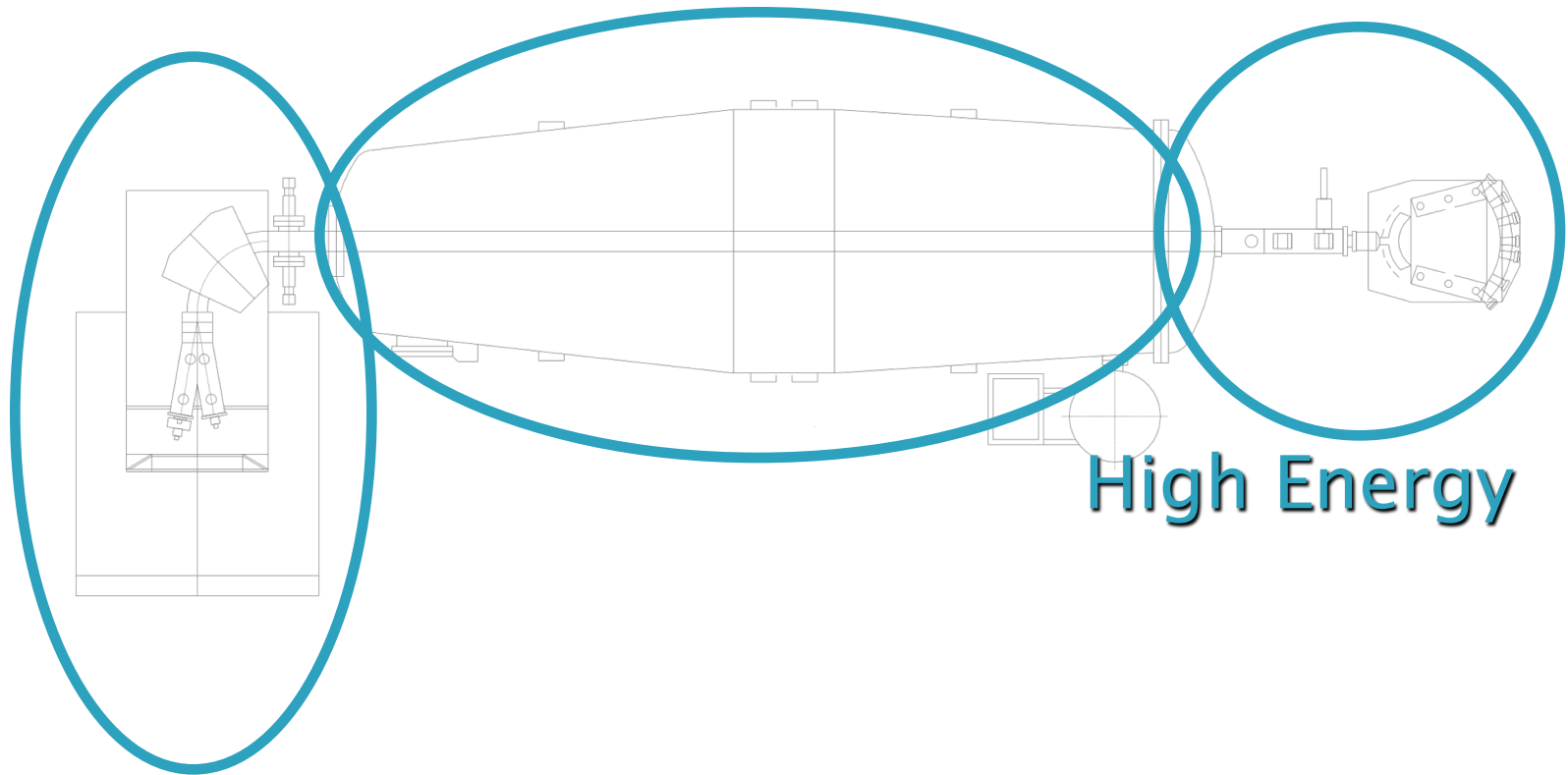

High Energy

Sources
and injector

Ion sources

- ▶ Two different sources at CMAM
 - Gas source (Duoplasmatron)
 - Produces positive or negative ions directly
 - Positive ions can be turned negative by passing through Lithium vapour produced by a Lithium canal
 - Sputtering source
 - Produces negative ions directly

Duoplasmatron

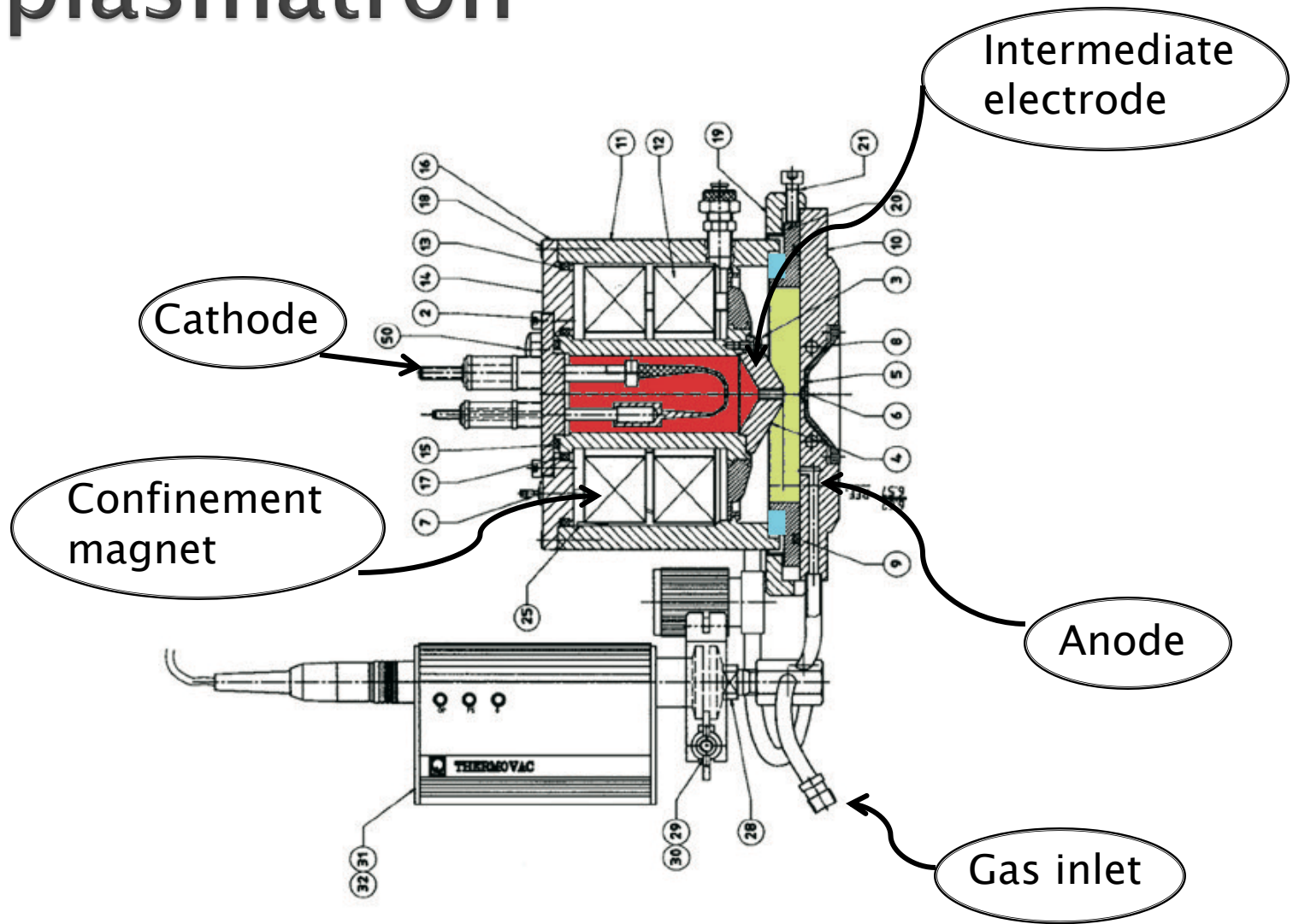

Sputtering source

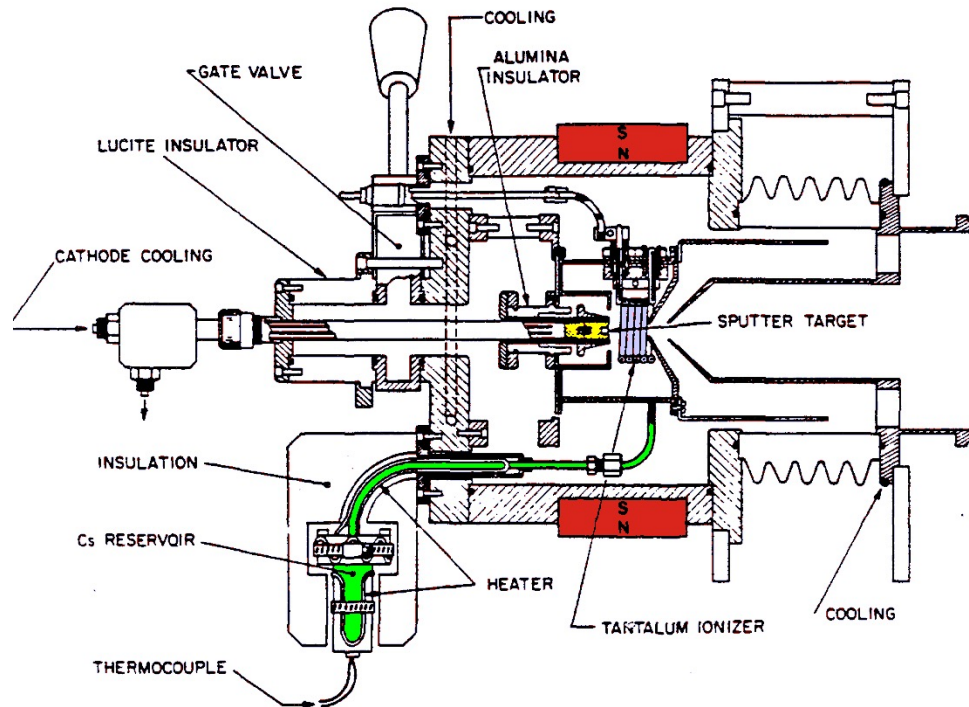

Production of negative ions

- ▶ **Unstable negative ions:**

N, Ne, Ar, Kr, Xe, Rn, Mg, Mn, Zn, Cd, Hg, some Lantanides
Molecular beams are used

- ▶ **Metastable negative ions:**

He, Be

Production of negative He ions

Charge exchange trough alkali metal (Li, Na, K, Rb) vapour

Efficiency 0.5 – 3%

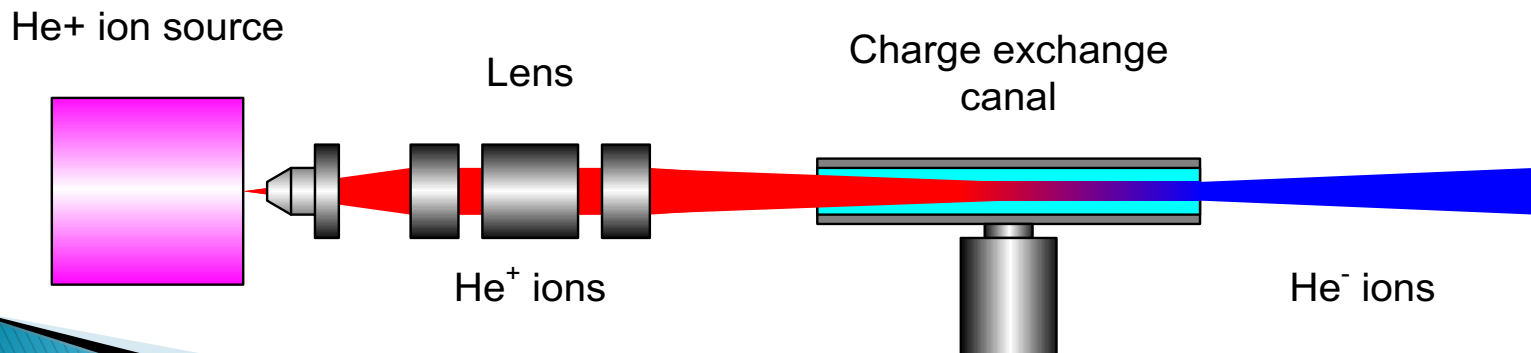

5 MV accelerator at CMAM

- ▶ Electrostatic tandem accelerator
- ▶ $V_{\max} = 5 \text{ MV}$
- ▶ $E_{\max} = 5(n+1) \text{ MeV}$
- ▶ Voltage generated by a Cockroft–Walton system
- ▶ Manufactured by High Voltage Engineering Europe

Tandem electrostatic accelerators

$$E_{\max} = E_{\text{ext}} + VT \cdot (q + 1) \cdot e$$

$$E_1 \text{ (MeV)} = 1 \cdot VT \cdot e$$

$$E_2 \text{ (MeV)} = q \cdot VT \cdot e$$

q = charge state

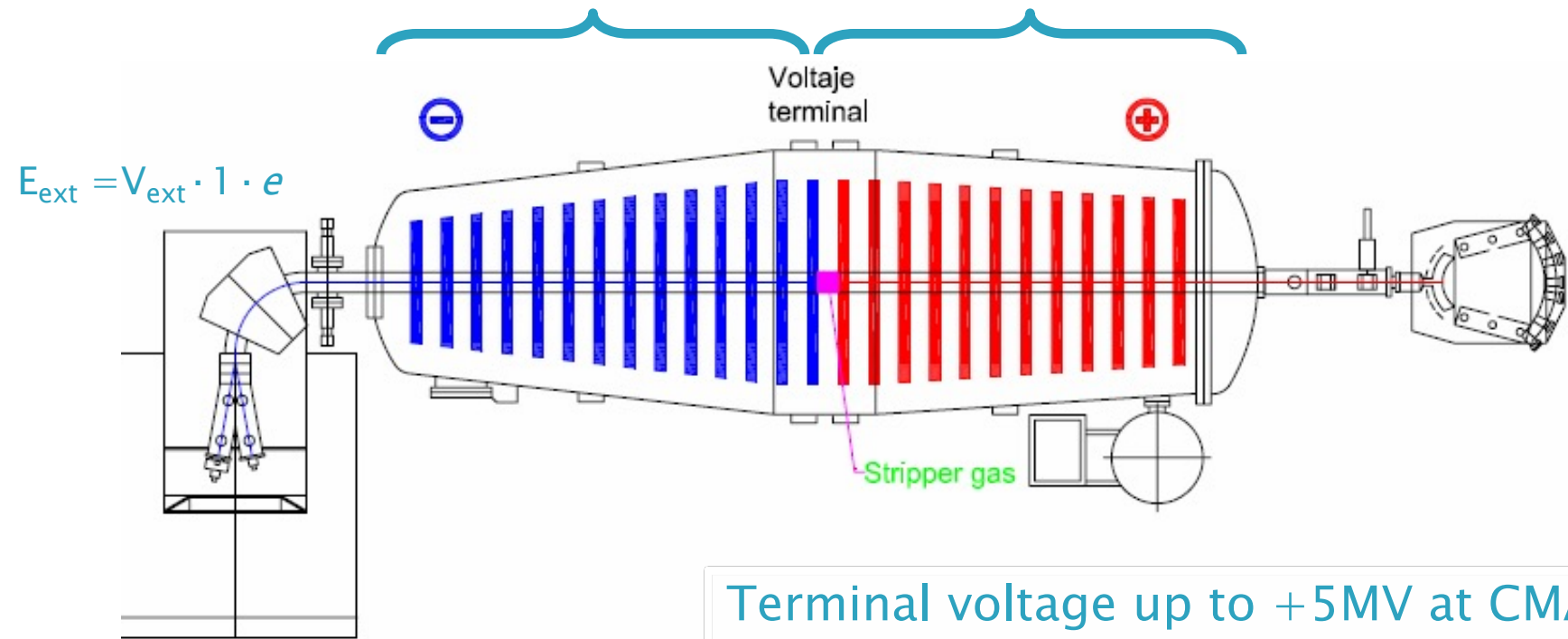

Cockcroft-Walton system

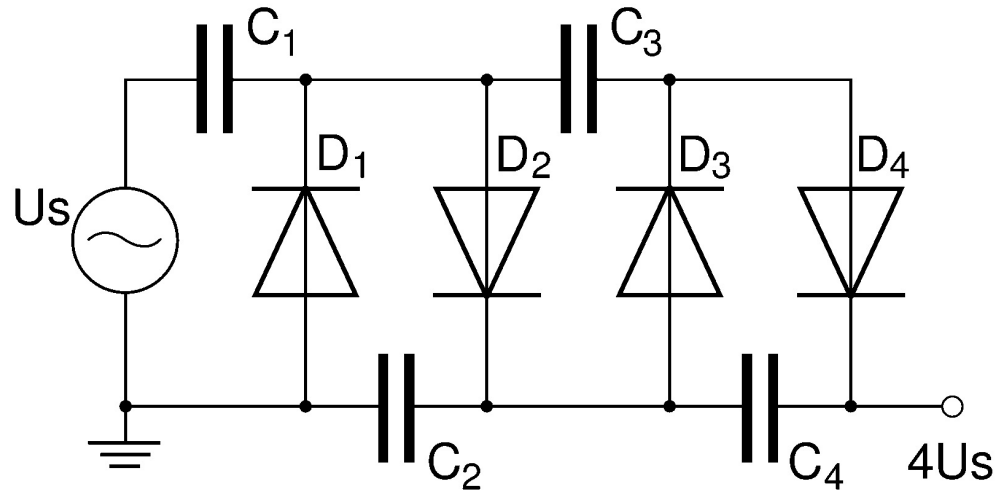

- ▶ High DC voltage obtained from AC signal
- ▶ No movable parts: very stable terminal voltage



Cockcroft-Walton accelerator

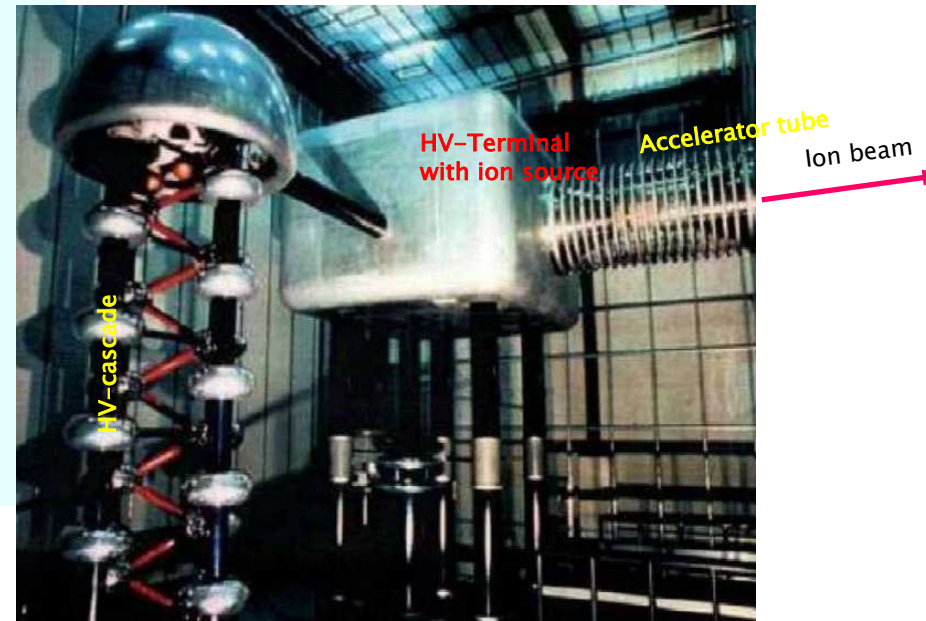
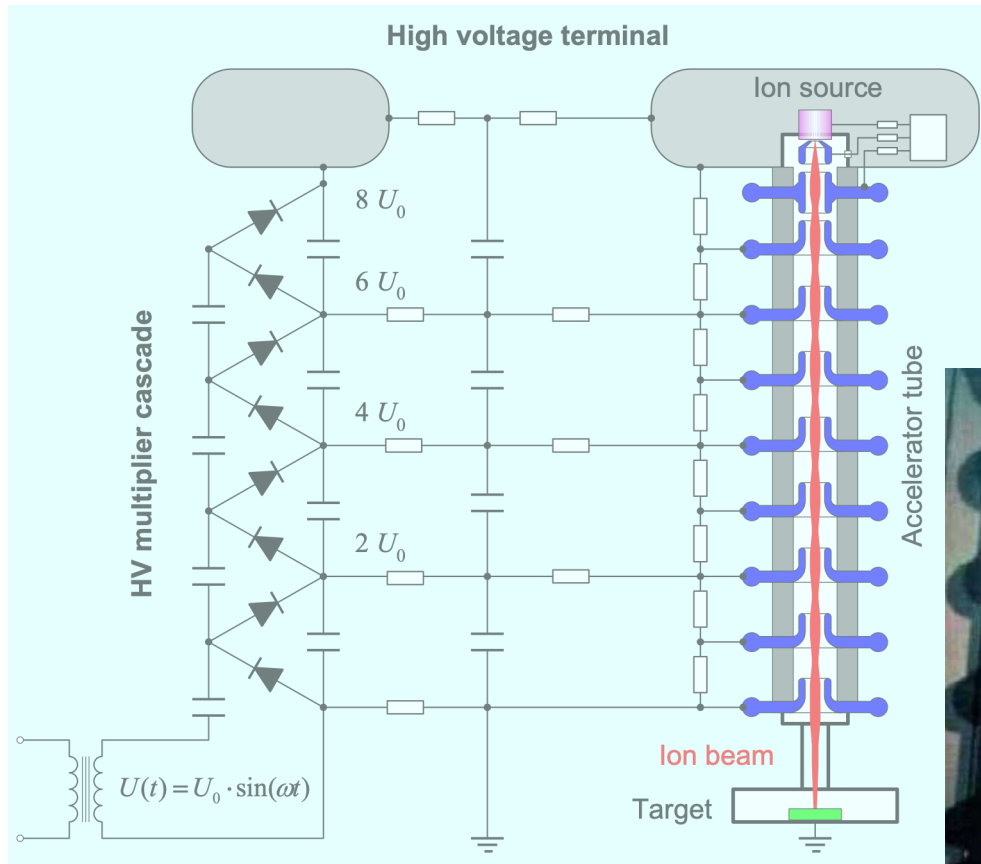

High Energy

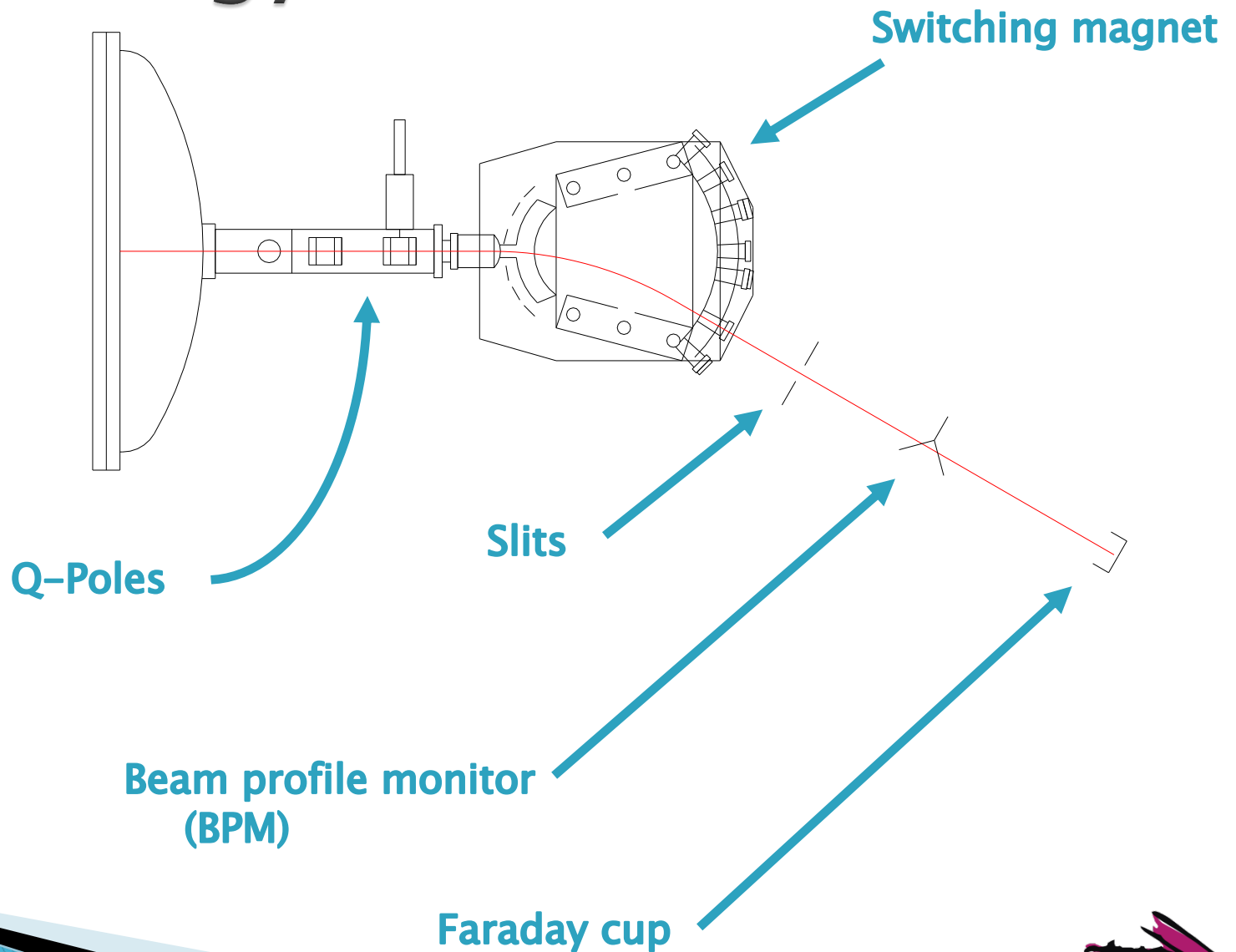

Q-Poles

- ▶ Used to focus the beam at a desired distance.
- ▶ Electrostatic or magnetic q-poles
- ▶ Focus only in one direction → at least a set of 2 are needed



Slits

- ▶ Define beam size and shape
- ▶ Made of very low activation material (eg. Ta)

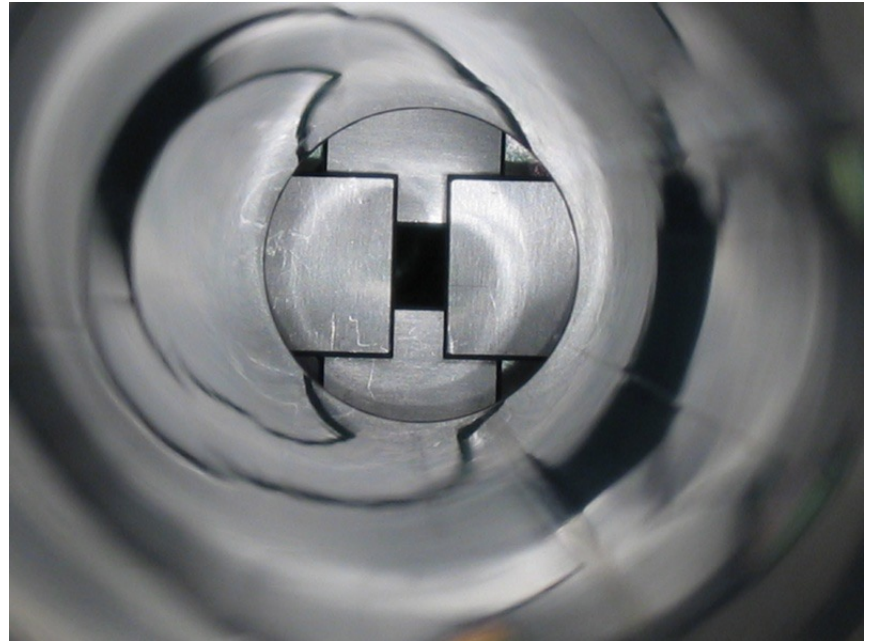

Beam Profile Monitor

- ▶ It allows to monitor shape and position of beam

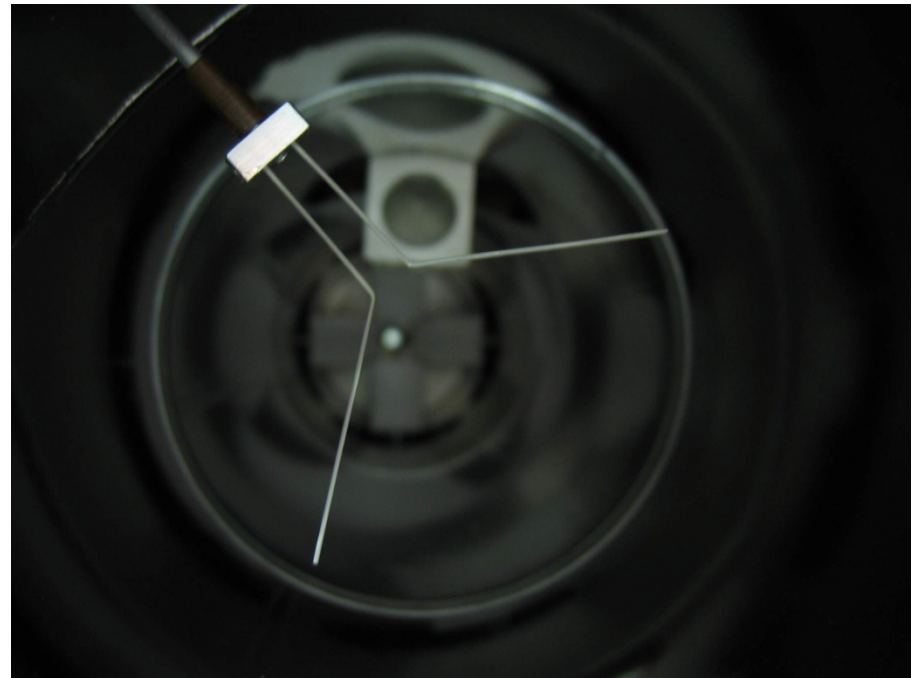
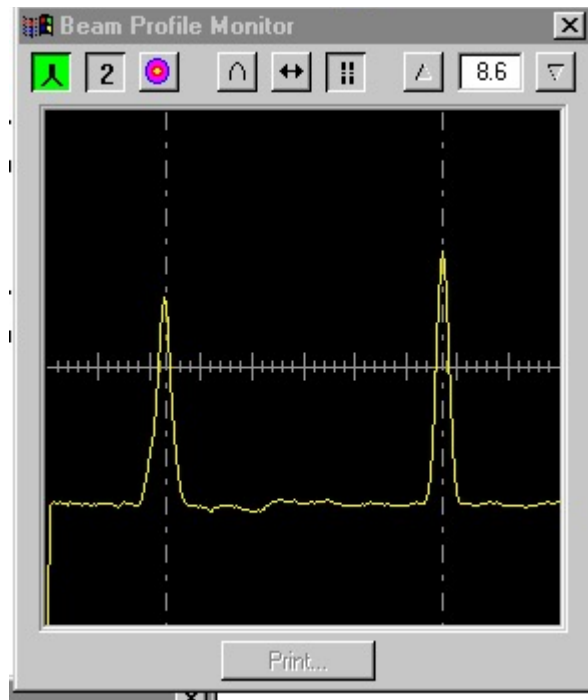

Faraday cups

To measure beam current

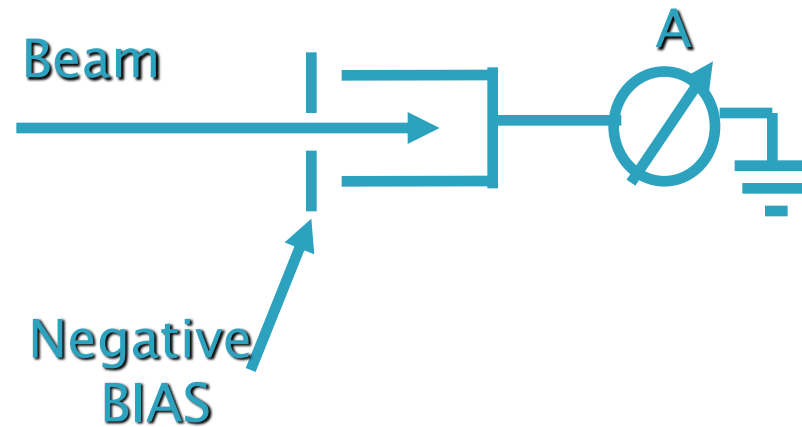

Sample holders

- ▶ Samples are installed on a sample holder, placed in a goniometer or any other device allowing the remote positioning of the sample

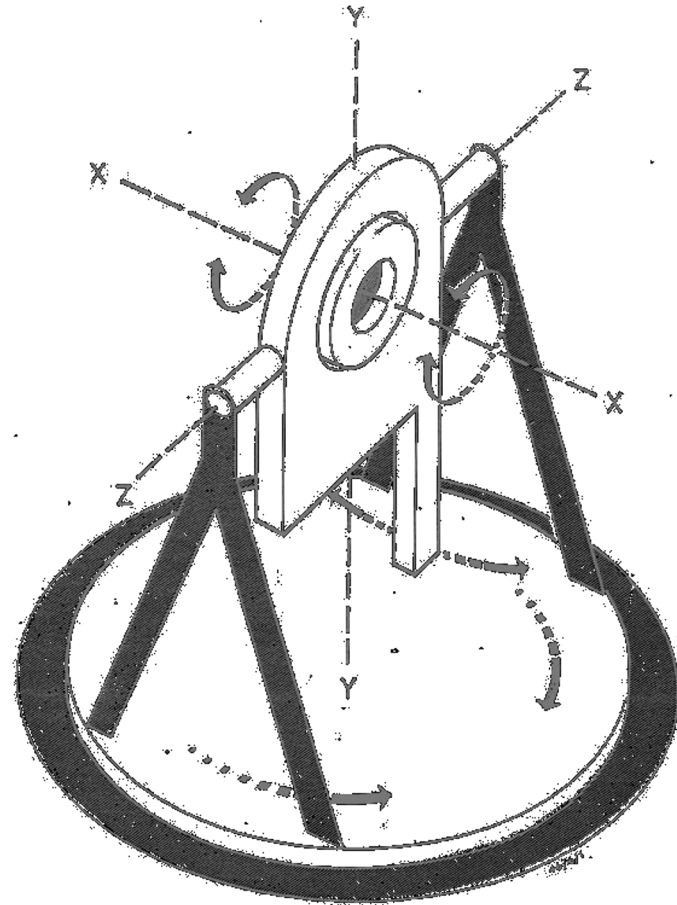

Detectors

- ▶ For particles
 - Solid State
 - Ionization chambers
 - Time of Flight telescopes
 - ...
- ▶ For electromagnetic radiation
 - Si(Li)
 - HPGe
 - Scintillators
 - ...

Visit to the CMAM accelerator hall

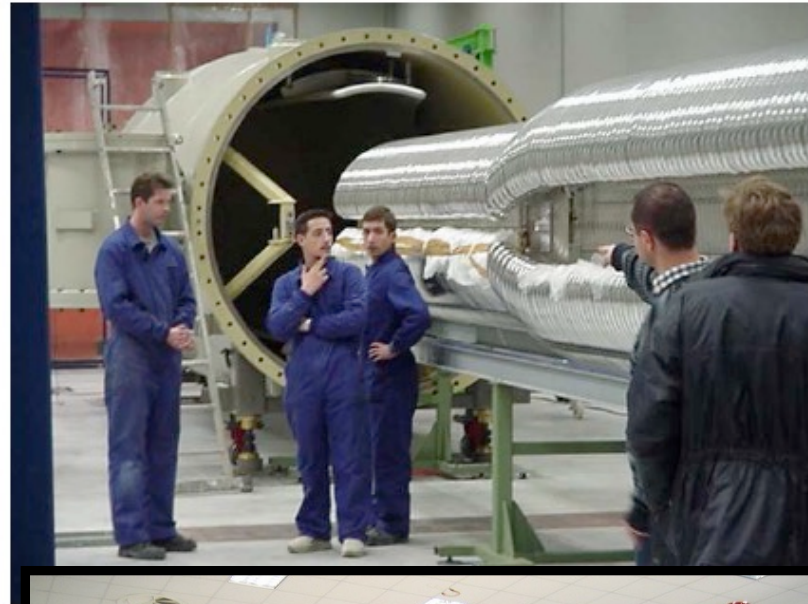



Como se construye un espectro de energia



Sonda: Rayos X, protones, alphas, etc..

Detector que transforma la energia depositada en señal electrica **proporcional** a la energia

ADC dispositivo que convierte la señal en un numero, generalmente de 1 a 4096 **proporcional** a la energia

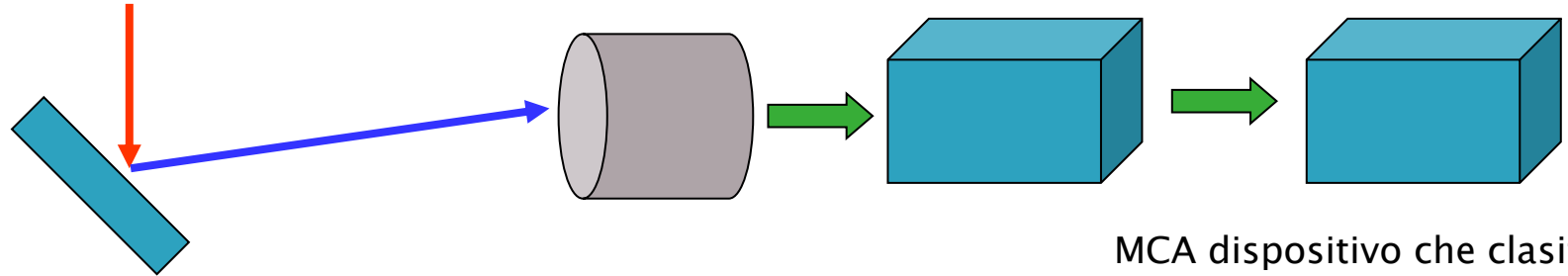

Muestra de donde salen por efecto de la repulsion coulombiana iones con diferentes energias segun el atomo blanco e incidente

MCA dispositivo que clasifica el evento segun el numero de 1 a 4096: un espectro de energia

Canales

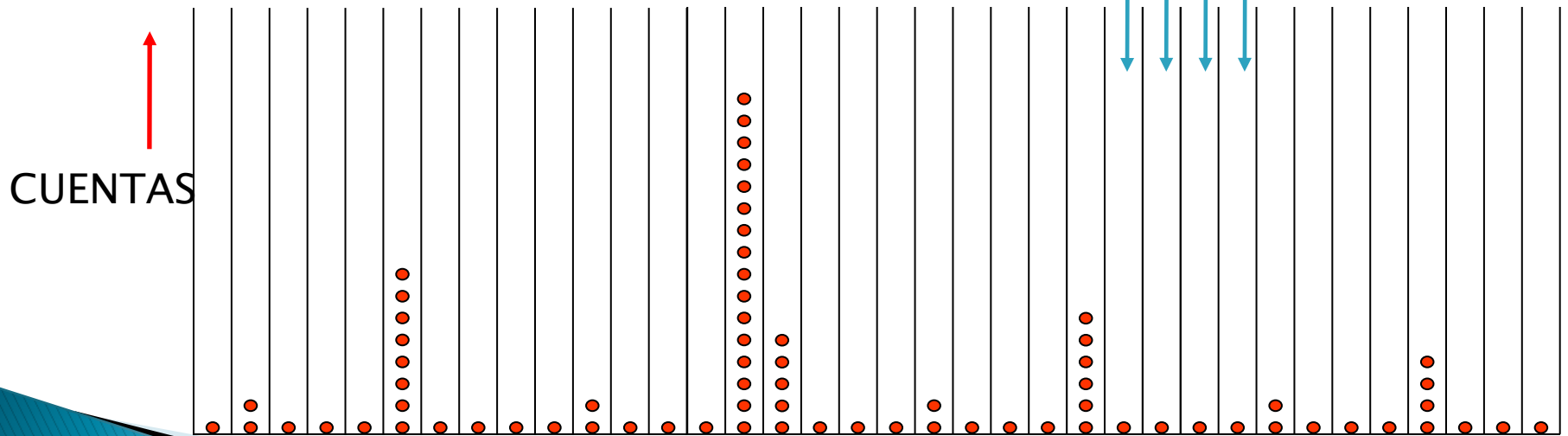

Calibración de la escala de energía



El número obtenido por el ADC es proporcional a la energía del rayo-X detectado

Utilizamos un **PATRON** para determinar la relación entre canal y energía

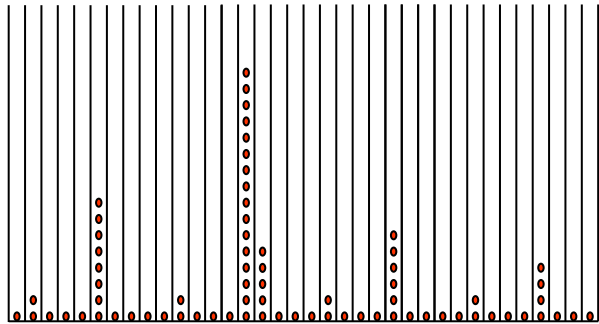

Calibro conociendo E_1 , E_2 , n_1 , n_2 y calculo a y b

$$E = a \cdot n + b$$

Ecuación general de una recta

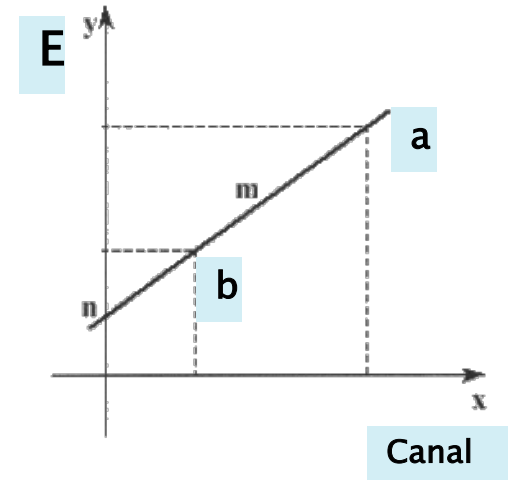

$$\left. \begin{array}{l} E_1 = a \cdot n_1 + b \\ E_2 = a \cdot n_2 + b \end{array} \right\} \quad a = \frac{E_1 - E_2}{n_1 - n_2} \quad b = \frac{1}{2} \frac{E_1 + E_2}{E_1 - E_2} \cdot \frac{n_1 - n_2}{n_1 + n_2}$$



Injection system

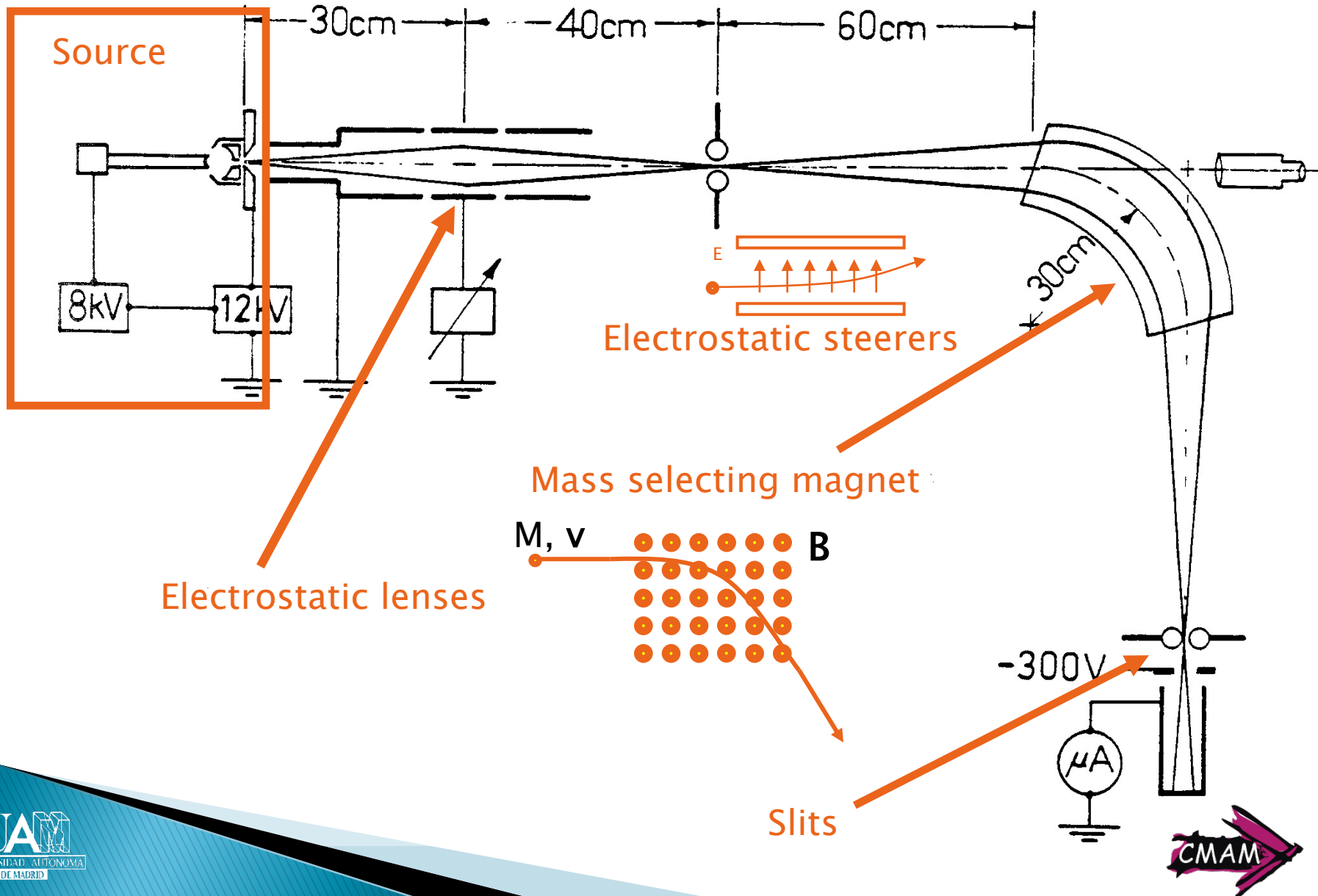

Iman selector de masas

