

Accelerator Physics Studies for Diamond-II

Ian Martin,

On behalf of the AP group

Diamond-II: challenges and novel solutions for upgrading
the national synchrotron light facility

Rutherford Appleton Laboratory

19th January 2024

Talk Outline

Diamond-II Storage Ring:

- Overall design goals
- Lattice design and main features

Injection Schemes:

- Standard four-kicker bump
- Injection using fast stripline kickers

RF Systems:

- Main and harmonic cavities
- Filling pattern and equilibrium electron bunch properties

Conclusions

Design Goals for Storage Ring

Design goals for Diamond-II storage ring:

1) Improve **quality of photon beams** delivered to users:

- Increase **spectral brightness and photon flux**
- Increase **transverse coherence**
- Reduced **spot size, line-width**
- Optimise **spectral range**

Achieved via reduction in natural emittance, increase in beam energy, new IDs

2) Increase **number of straight sections**:

- Space for **new beamlines**
- **Choice of source for existing dipole** beamlines (bending magnet / undulator / 3-pole wiggler)
- Space for ancillary components (RF cavities, diagnostics equipment, injection components, ...)

Diamond-II aims to combine both low emittance with high capacity

Diamond-II Structure

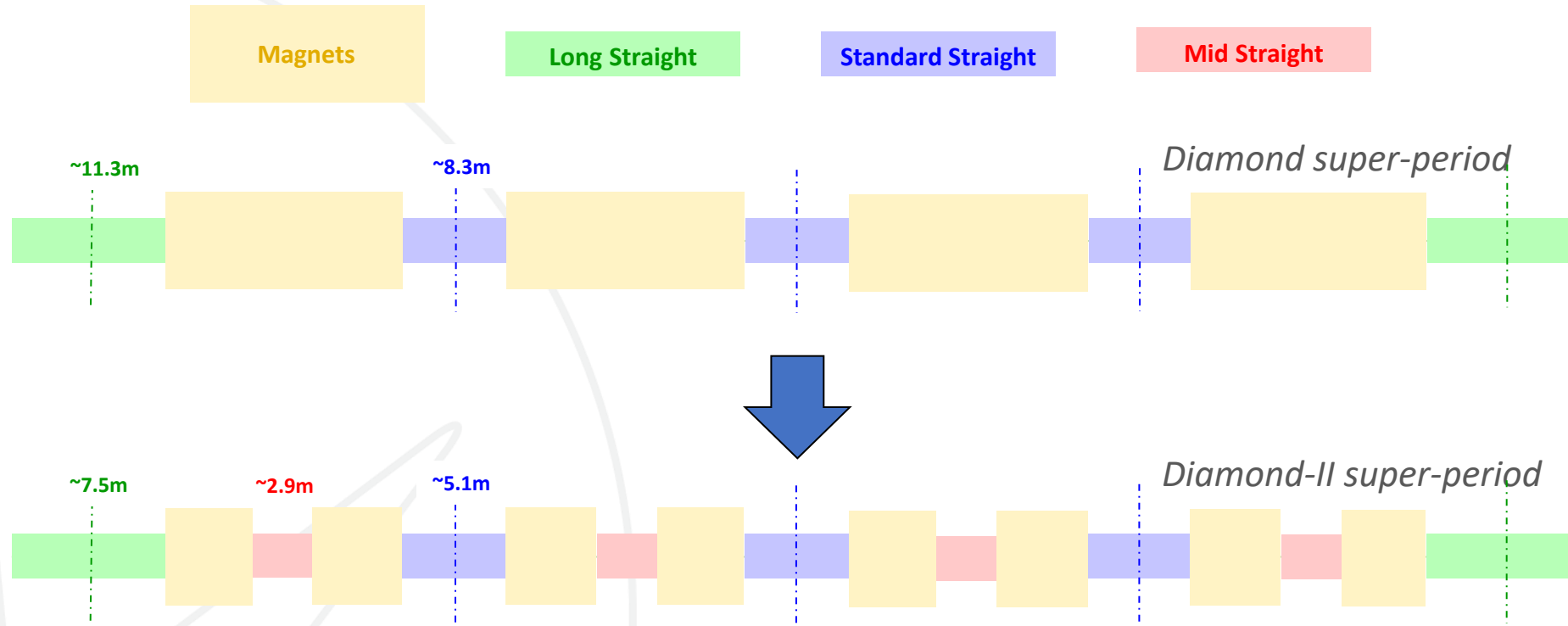

6 long straights, ~7.5 m long:

18 standard straights, ~5.2 m long:

24 mid straights, ~2.9 m long:

IDs, injection elements

IDs

IDs, 3PW/dipole sources, RF, 3HC, diagnostics, stripline kickers

>35 % of the ring consists of insertion straights (quad to quad)

Diamond-II Cell Design

Design for Diamond-II is a 'Modified Hybrid 6 Bend Achromat'
Combines two concepts:

- The ESRF-EBS cell (Hybrid 7 Bend Achromat)
- The Diamond Double-Double Bend Achromat cell

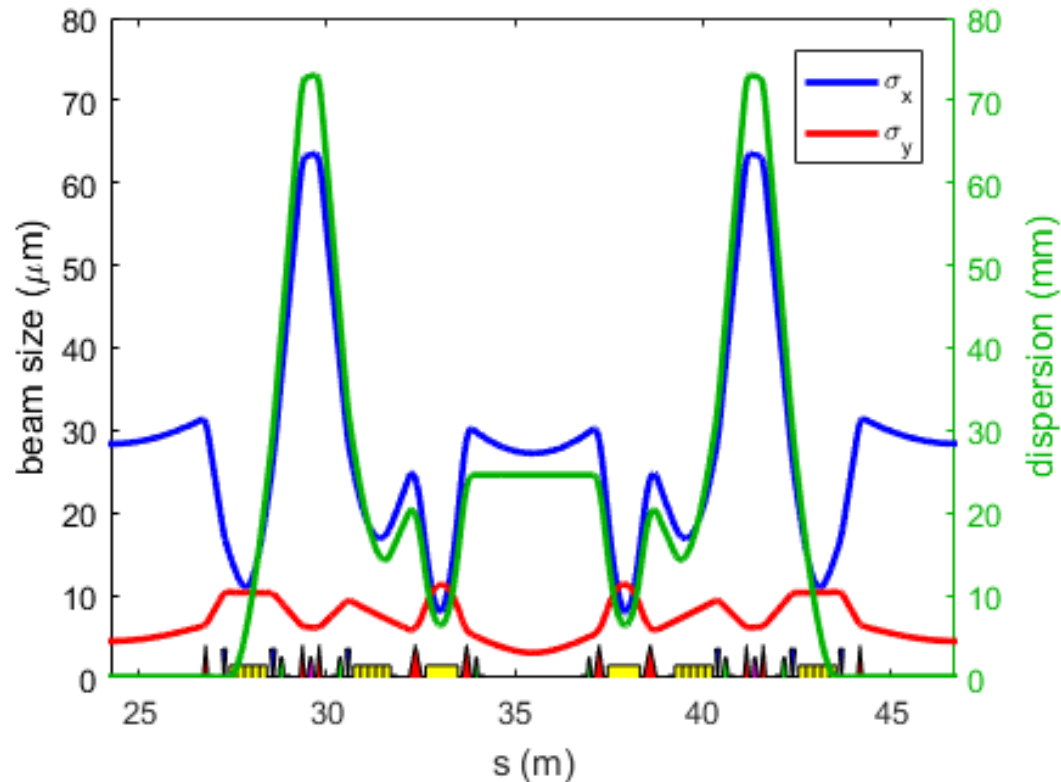

	Diamond	Diamond-II
Lattice Type	DBA	M-H6BA
Circumference	561.6 m	560.561 m
Straight Sections	24	48
Energy	3 GeV	3.5 GeV
Beam Current	300 mA	300 mA
Natural Emittance	2.7 nm.rad	161 pm.rad
Natural Energy Spread	0.096 %	0.094 %
Equilibrium Emittance	3.1 nm.rad	120 pm.rad
Equilibrium Energy Spread	0.107 %	0.109 %

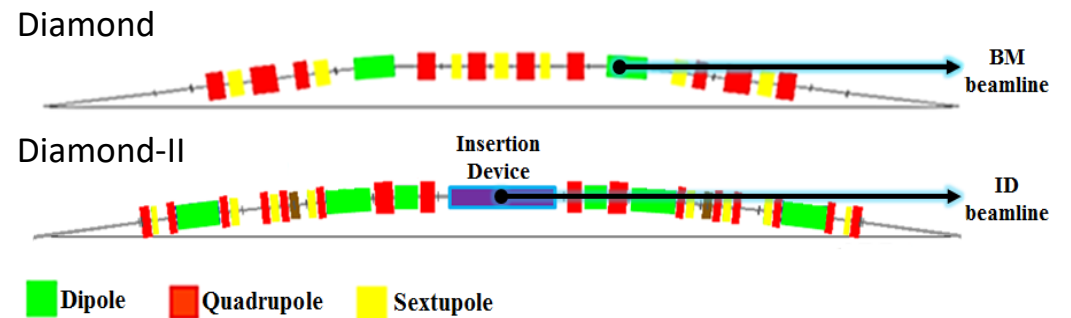

Diamond-II Cell: Multi-Bend Achromat

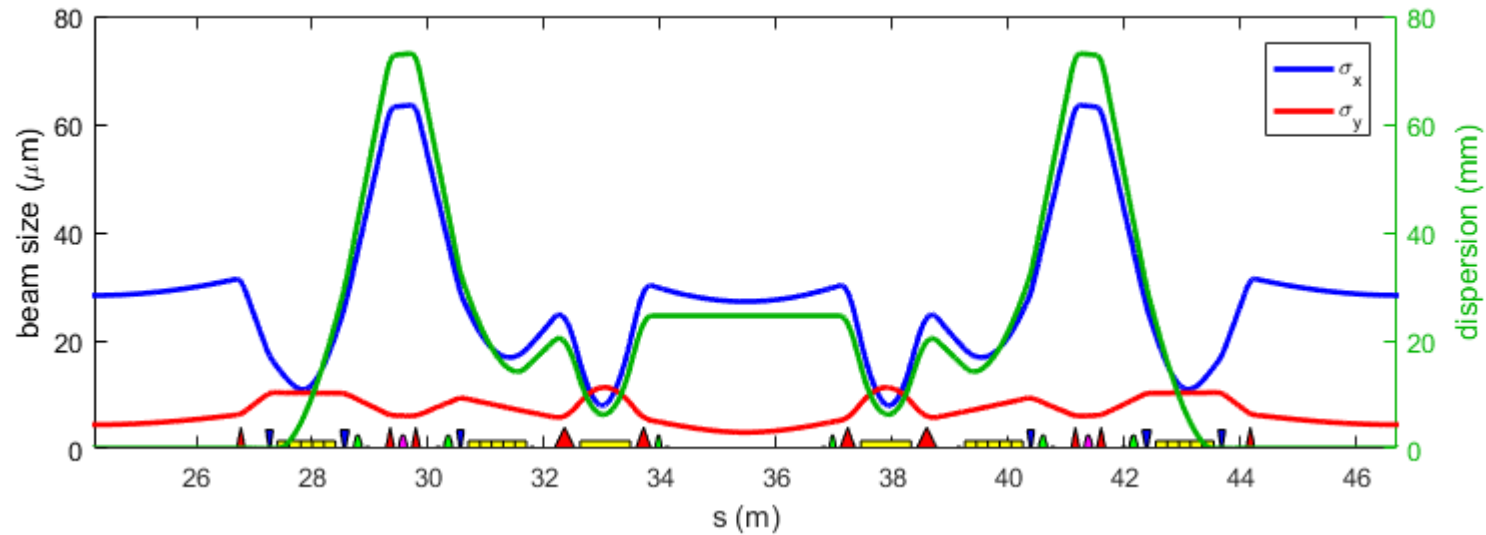

Emittance reduced by increasing number of bending magnets (scaling $\sim 1/N_d^3$)

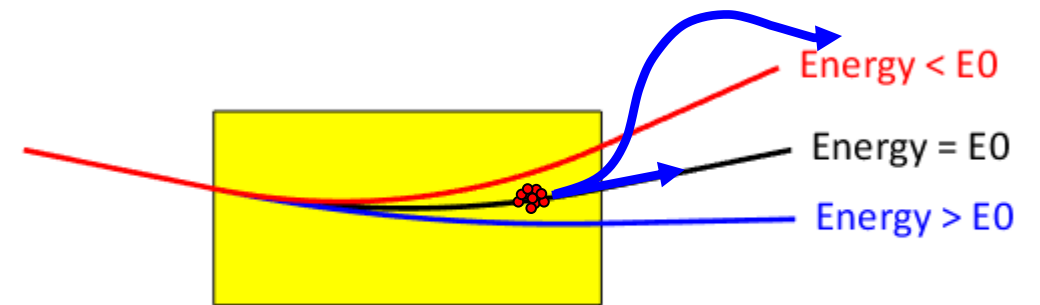
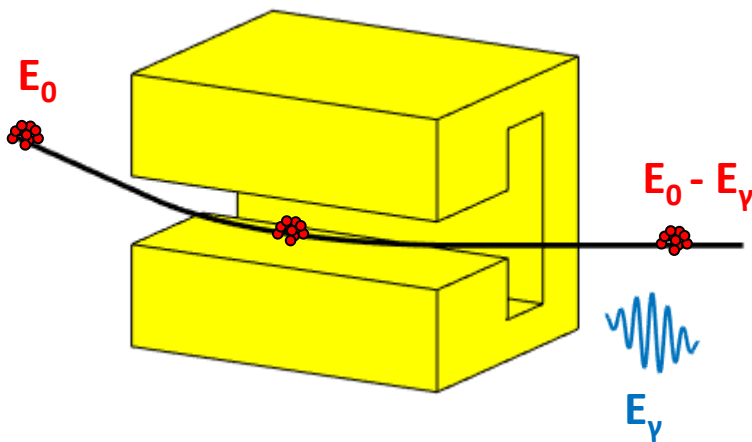

Diamond-II Cell: Longitudinally-Varying Bends

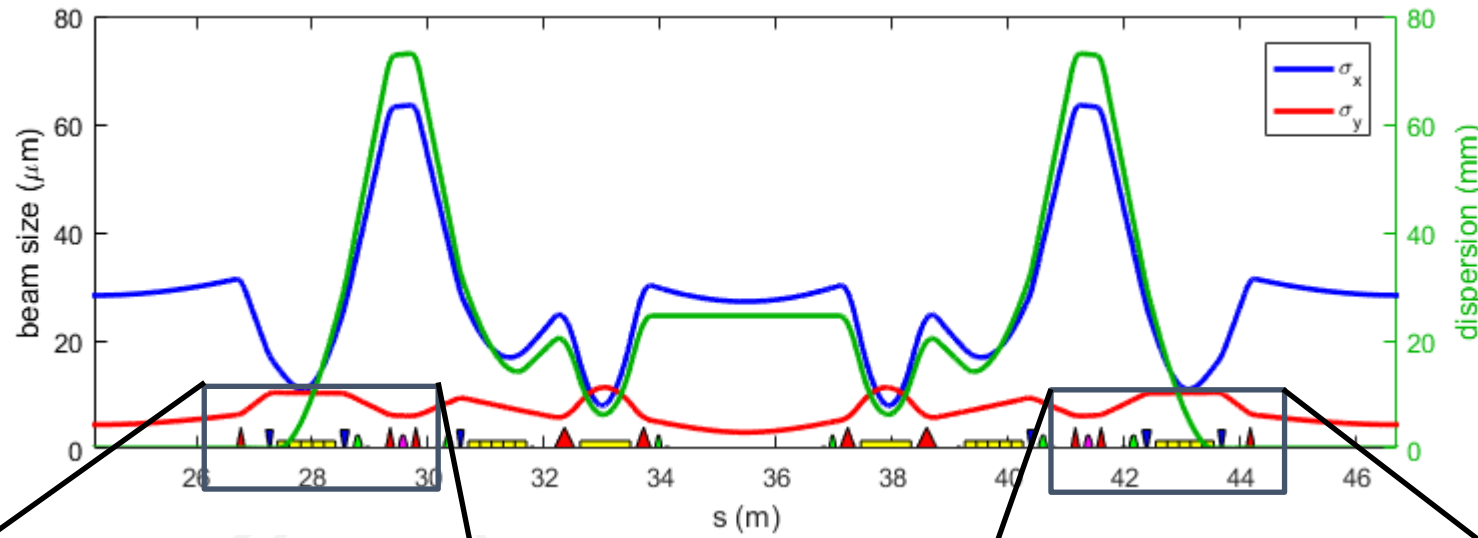

Emittance reduced by **shaping longitudinal profile** of the bending magnets (follow the dispersion)

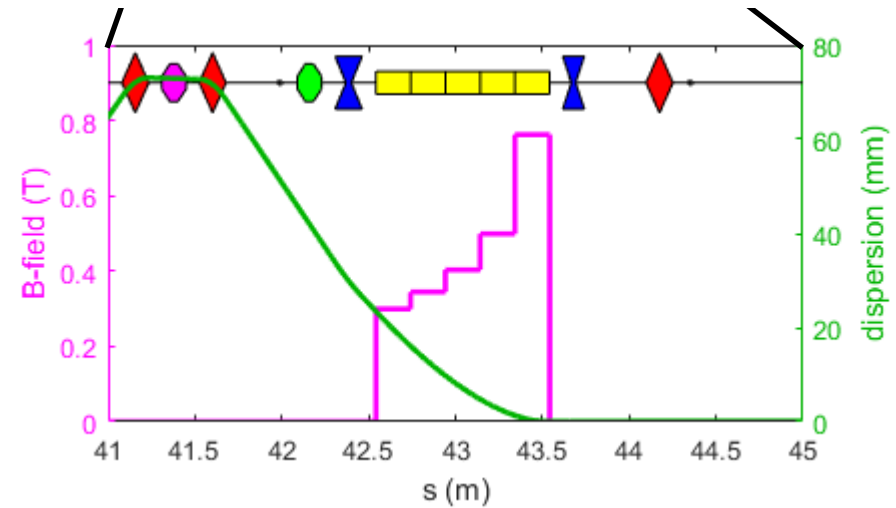
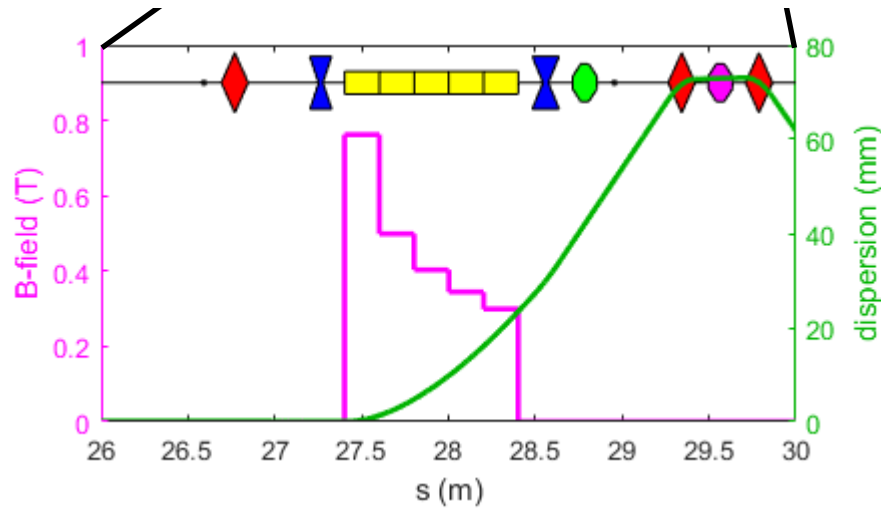

Diamond-II Cell: Dispersion Bump

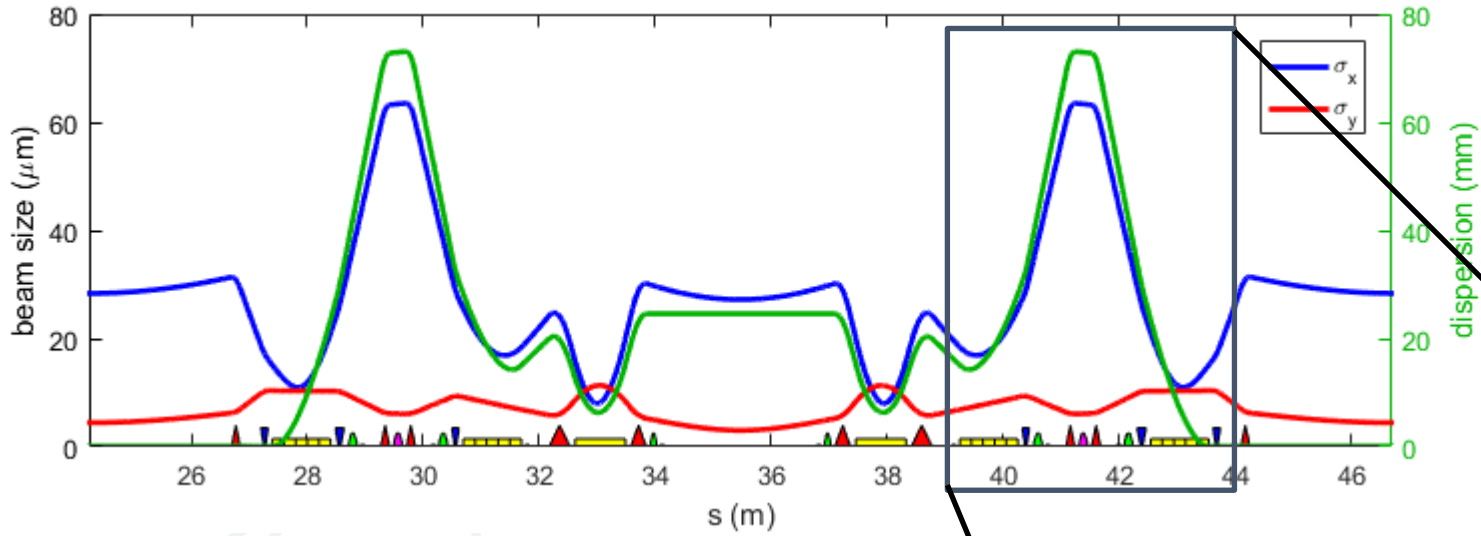

Control of electron beam dynamics eased by maximising dispersion between bends:

- Helps to lower strength of sextupoles
- Improved lifetime
- Improved injection efficiency

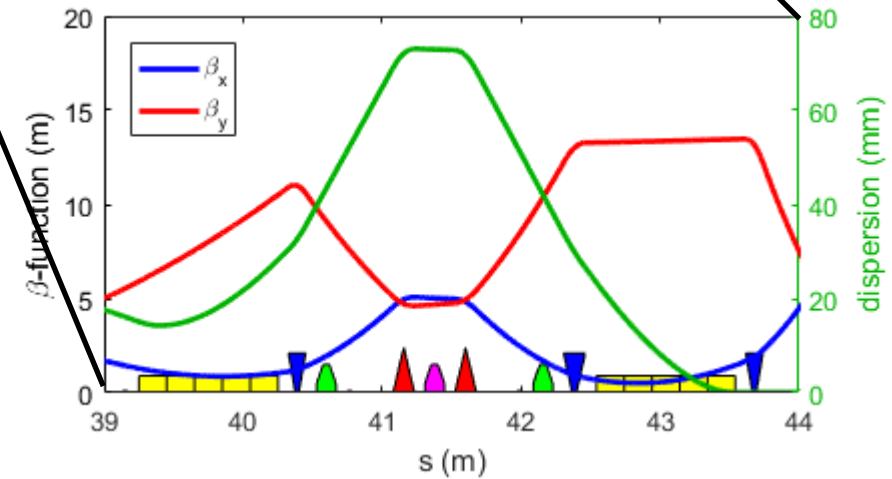
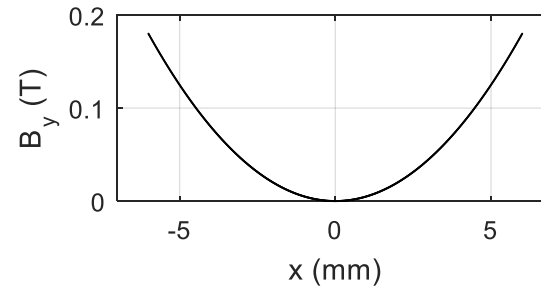

Diamond-II Cell: '-I Transformer'

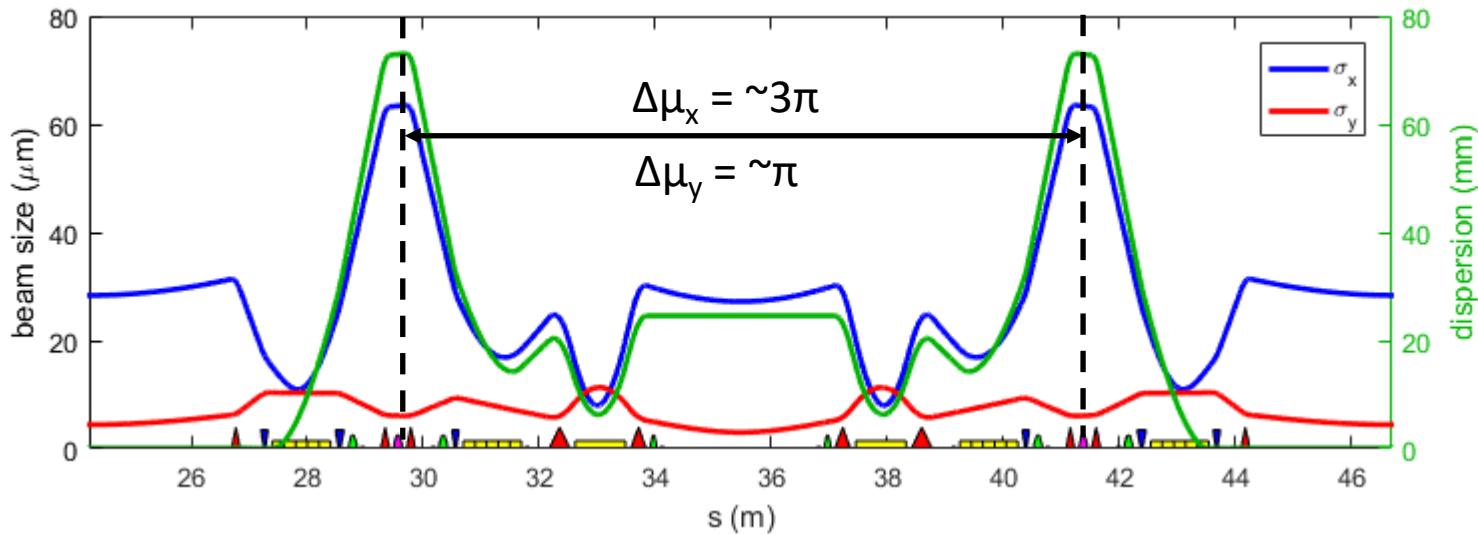

Phase advance between strong sextupoles set to **odd multiple of π radians**

- Systematic perturbations locally cancelled automatically
- Reduces need for elaborate harmonic sextupole compensation schemes
- Improved lifetime
- Improved injection efficiency

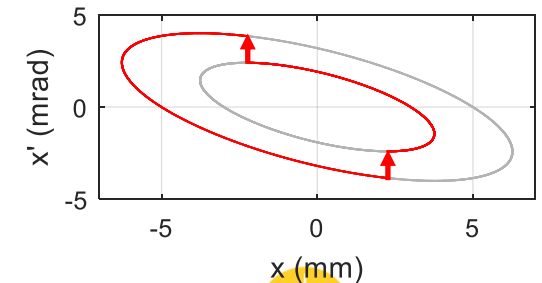
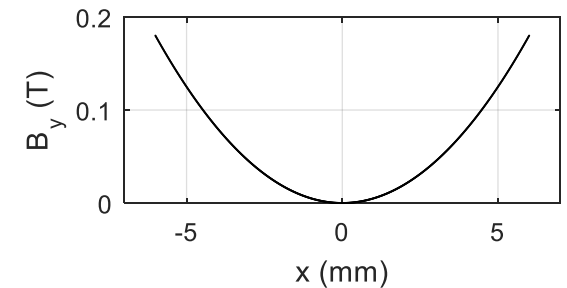

Diamond-II Cell: Anti-bends

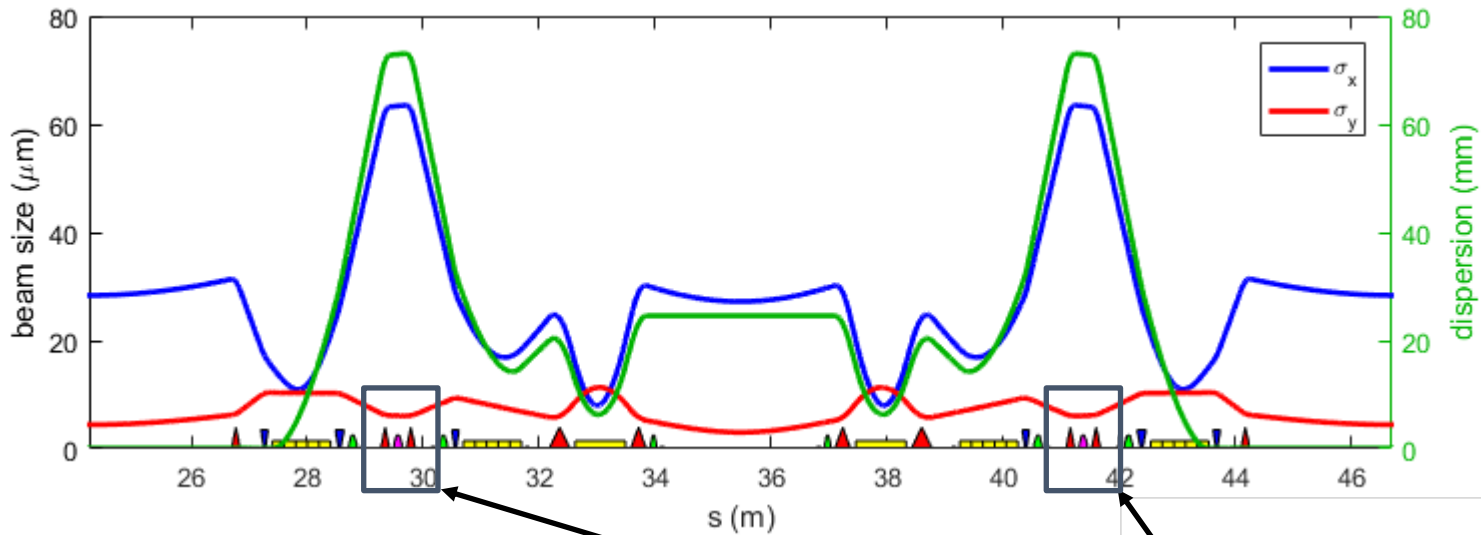

Dispersion control by using **opposite polarity bending** magnets

- Implemented as displaced quadrupoles
- Allows to reduce dispersion in main bends ...
- ... or alternatively increase dispersion at sextupoles

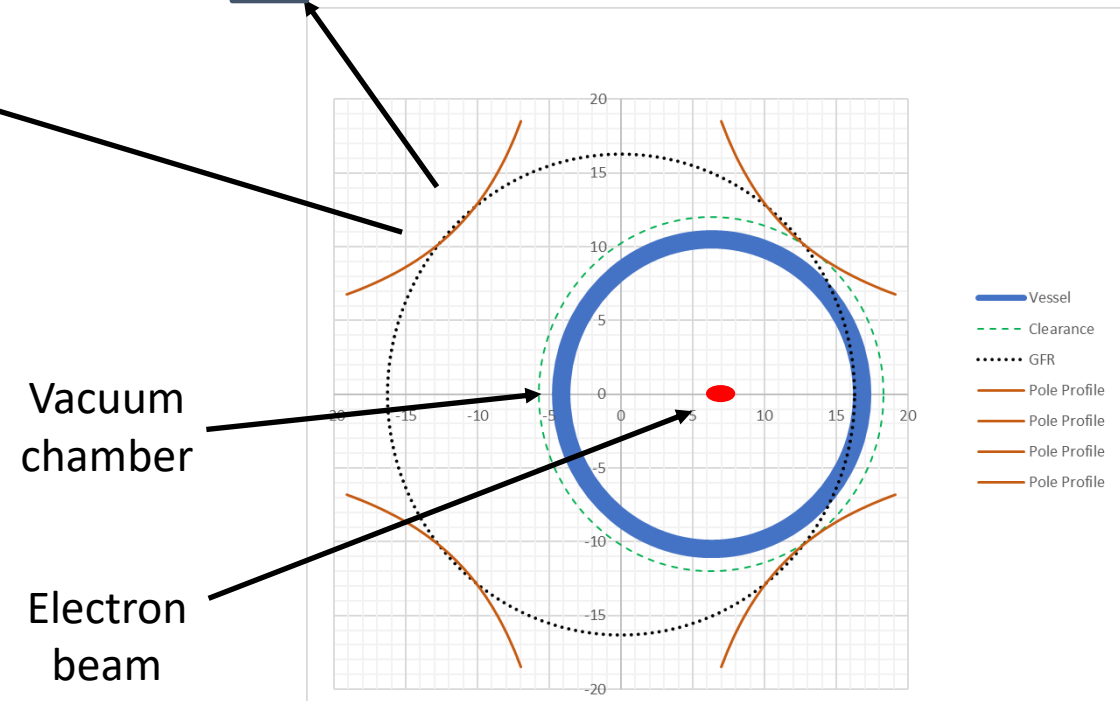

Electron Beam Size

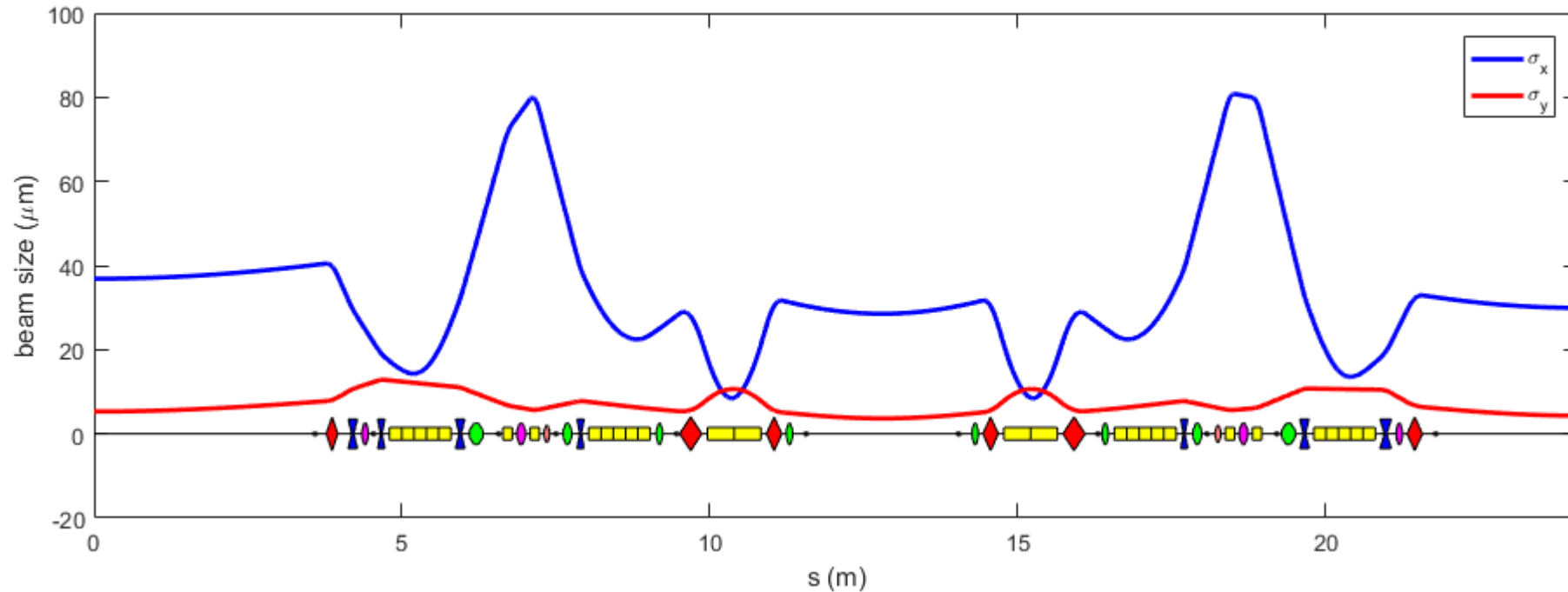

	Long Straight		Standard Straight		Mid Straight	
	Diamond	Diamond-II	Diamond	Diamond-II	Diamond	Diamond-II
σ_x (μm)	178.9	35.9	124.1	29.2	84.7	27.8
$\sigma_{x'}$ (μrad)	16.4	4.3	24.0	5.3	41.7	8.2
σ_y (μm)	6.8	5.3	3.5	4.3	4.2	3.7
$\sigma_{y'}$ (μrad)	1.2	1.5	2.3	1.9	1.9	2.2

Diamond Cell Evolution

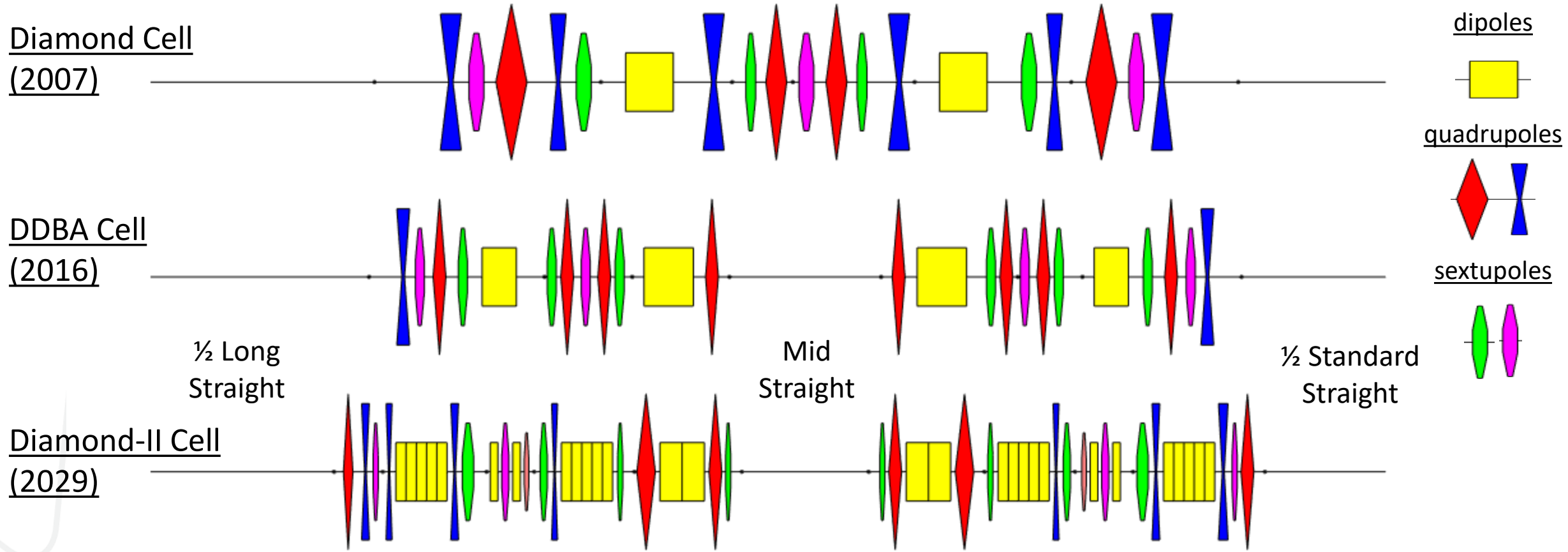

	Requirement	Diamond	DDBA Cell	Diamond-II
Long straight	>7.44 m	11.3 m	-	7.545 m
Standard straight	>4.884 m	8.3 m	-	5.065 m
Mid straight	>2.9 m	-	3.4 m	2.872 m
# Magnets per cell	-	19	24	36 (37)

Diamond-II Challenges

Diamond-II storage ring will be more difficult to operate than the existing ring.

Main challenges:

- 1) Stronger focussing lattice leads to reduction in transverse and energy acceptance
 - Harder to inject
 - Shorter lifetime
- 2) Smaller physical apertures required to reach target magnetic fields
 - Engineering design
 - Stronger wakefields => more susceptible to beam instabilities

Solutions:

- 1) New injection scheme(s)
- 2) New RF systems (harmonic cavity)

Dynamic Aperture Reduction for Diamond-II

Diamond

S. Smith, J. Jones, H. Owen, EPAC'02

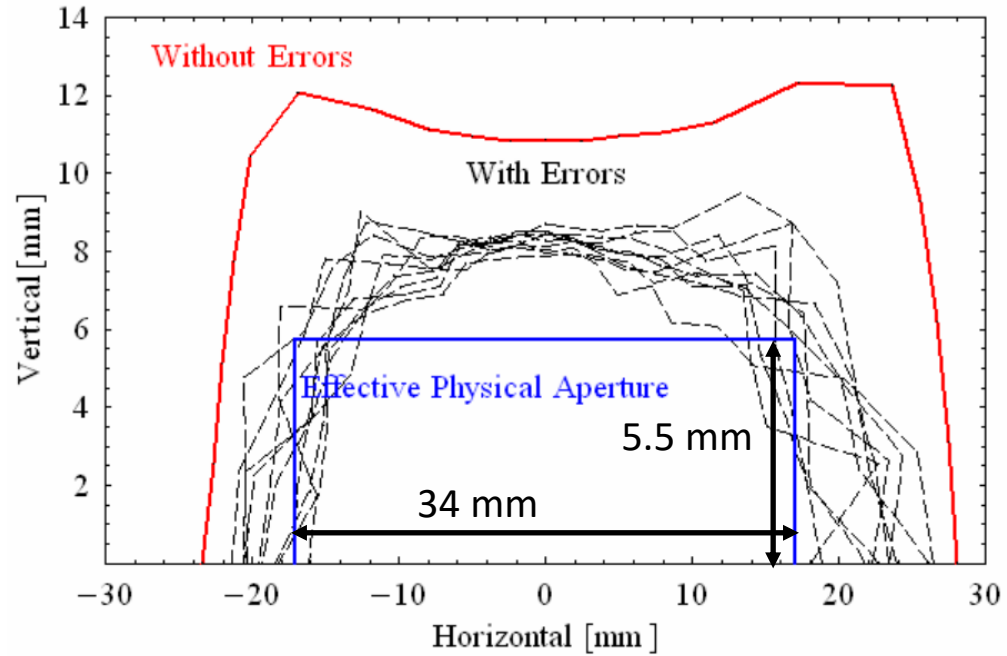

Diamond-II

H.C. Chao, Diamond-II TDR, 2022

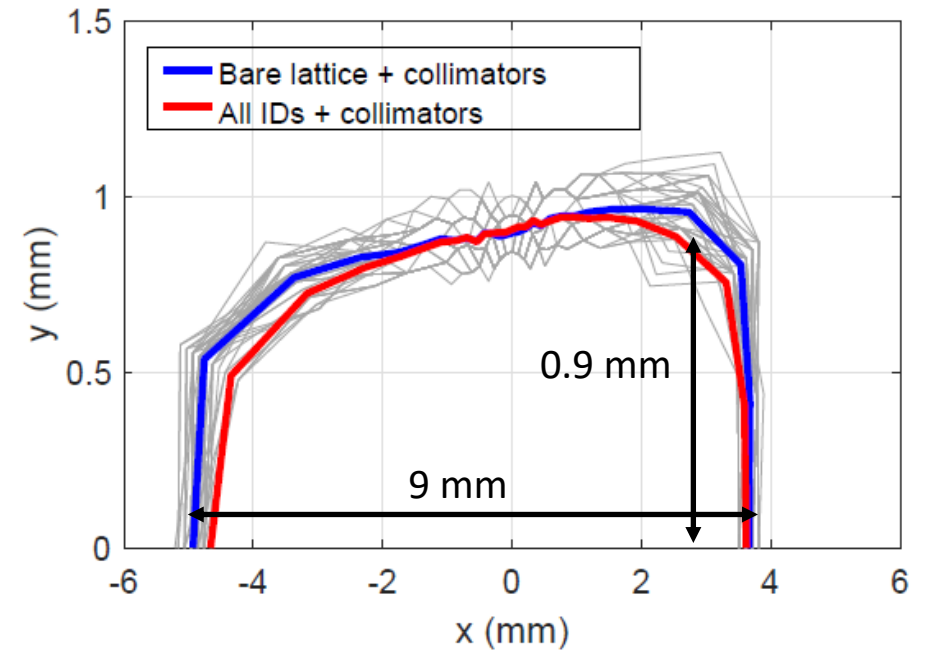

Diamond

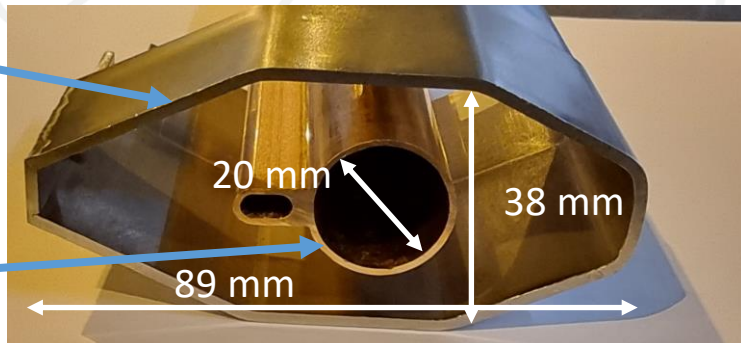

Diamond-II

⇒ Factor 4 reduction in available aperture horizontally

⇒ Factor 6 reduction in available aperture vertically

Injection Schemes

Diamond-II will operate two different injection schemes:

1) Standard four kicker bump (single or multi-bunch)

- Robust, proven technology
- Can be adjusted for different stages during commissioning:
 - single shot, on-axis injection
 - off-axis accumulation with closed orbit bump
- Baseline injection scheme for re-filling during operations
- Downside: difficult to make injection invisible to users due to technology limitations

2) Stripline kicker injection (single bunch only)

- Used for top-up injection with shutters open (improved transparency: 1 bunch in 899 kicked)
- 'Aperture-sharing' or 'kick-and-cancel' configurations

Four Kicker Bump

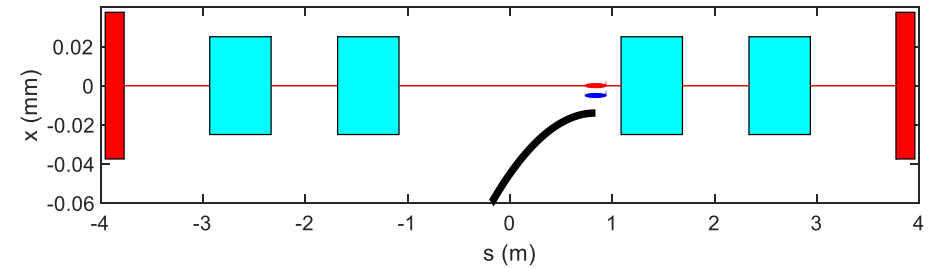
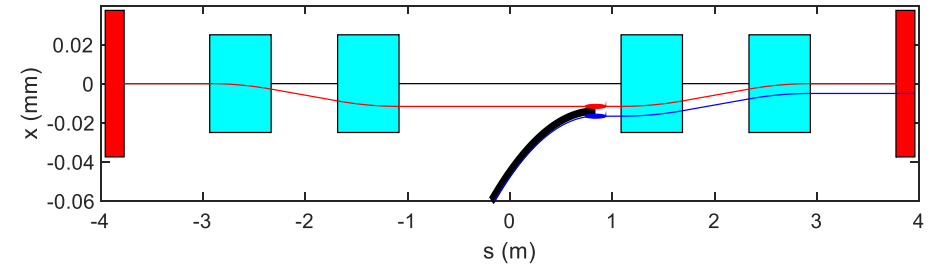

Aperture Sharing

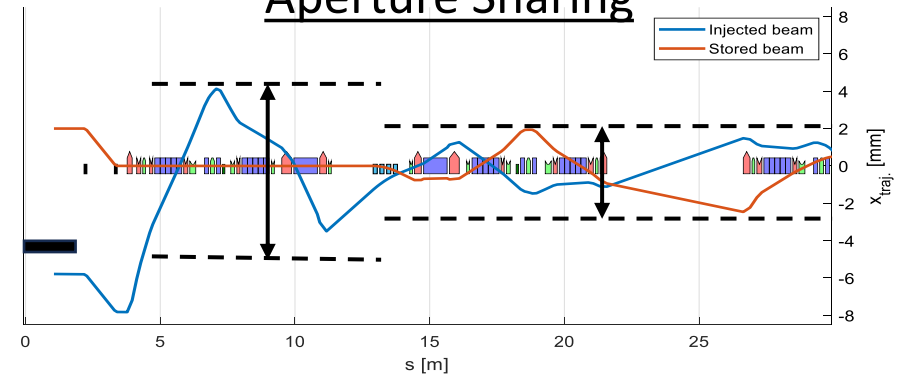

Injection Layout

I01 Injection Straight

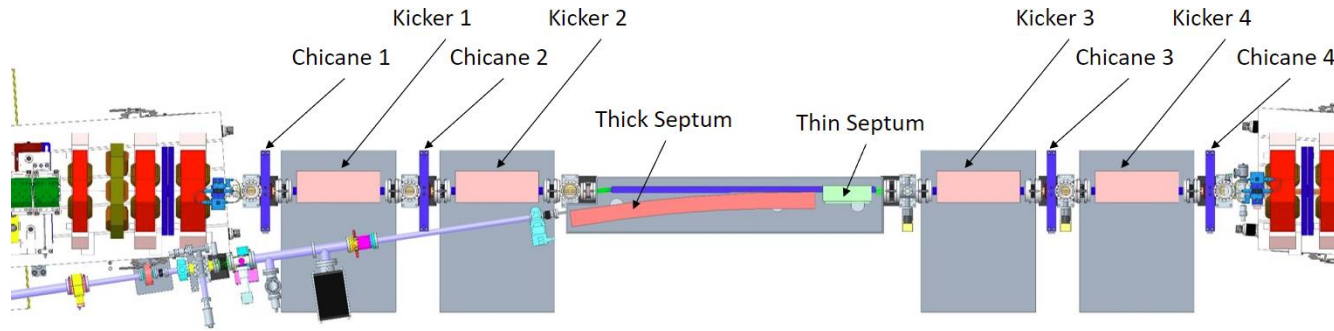

K01 Injection Straight

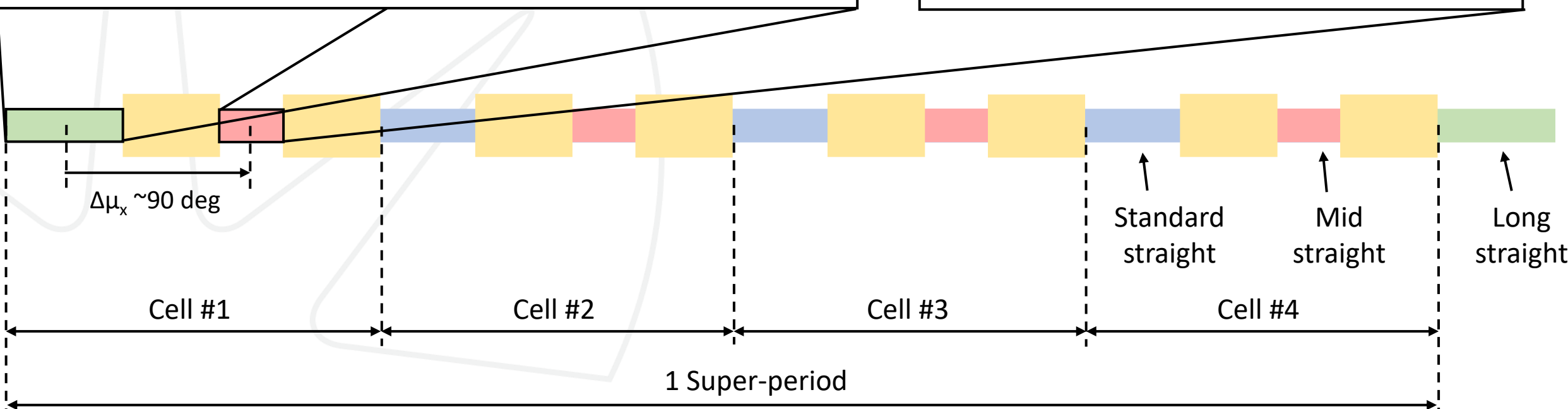
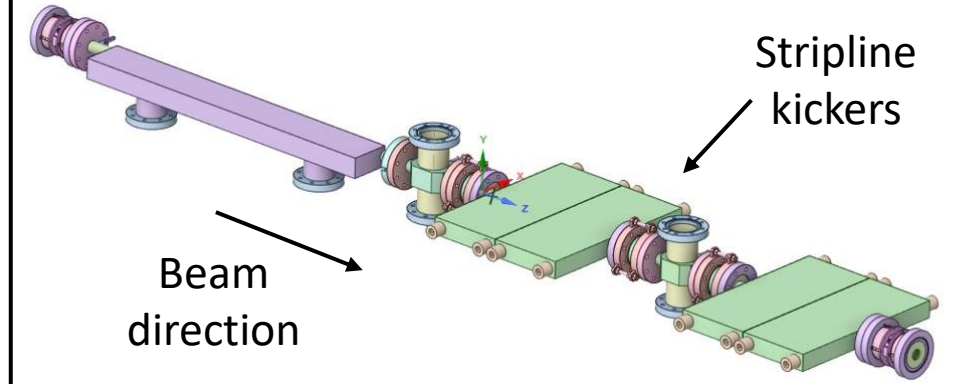

'Aperture-Sharing' Injection

Baseline top-up injection is 'aperture-sharing'

- Four × 0.15 m long striplines in first mid straight
- Ideal pulse: <3 ns full width, ±20 kV
- Single bunch injection only
- Only 1 bunch in 899 will be disturbed

Much improved transparency!

Prototype pulser under development (Kentech Ltd.)

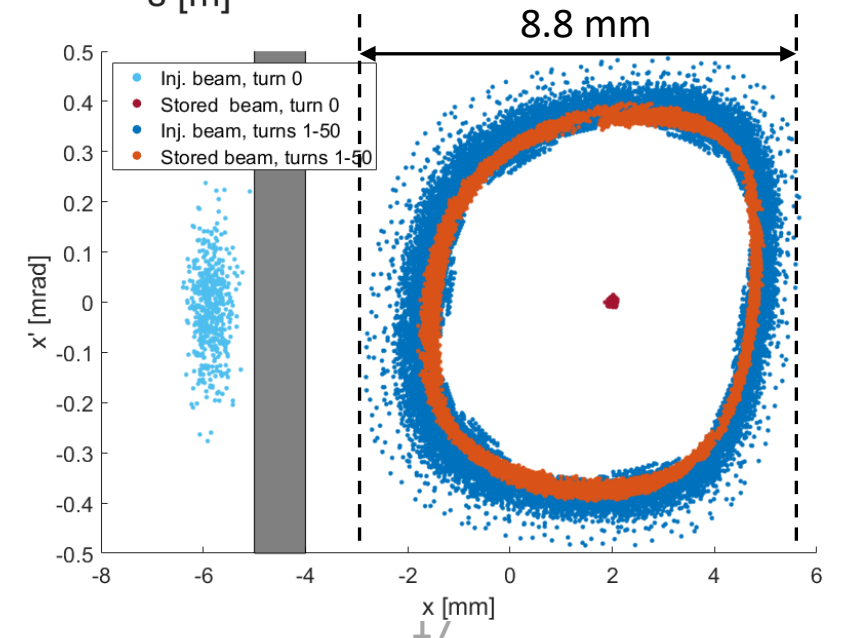
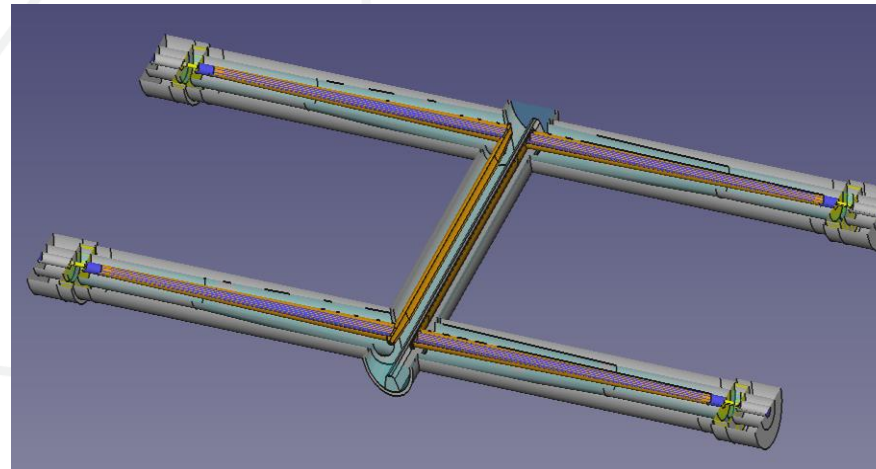
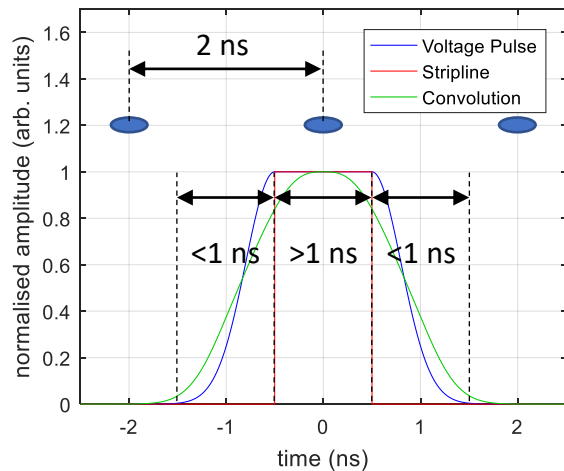
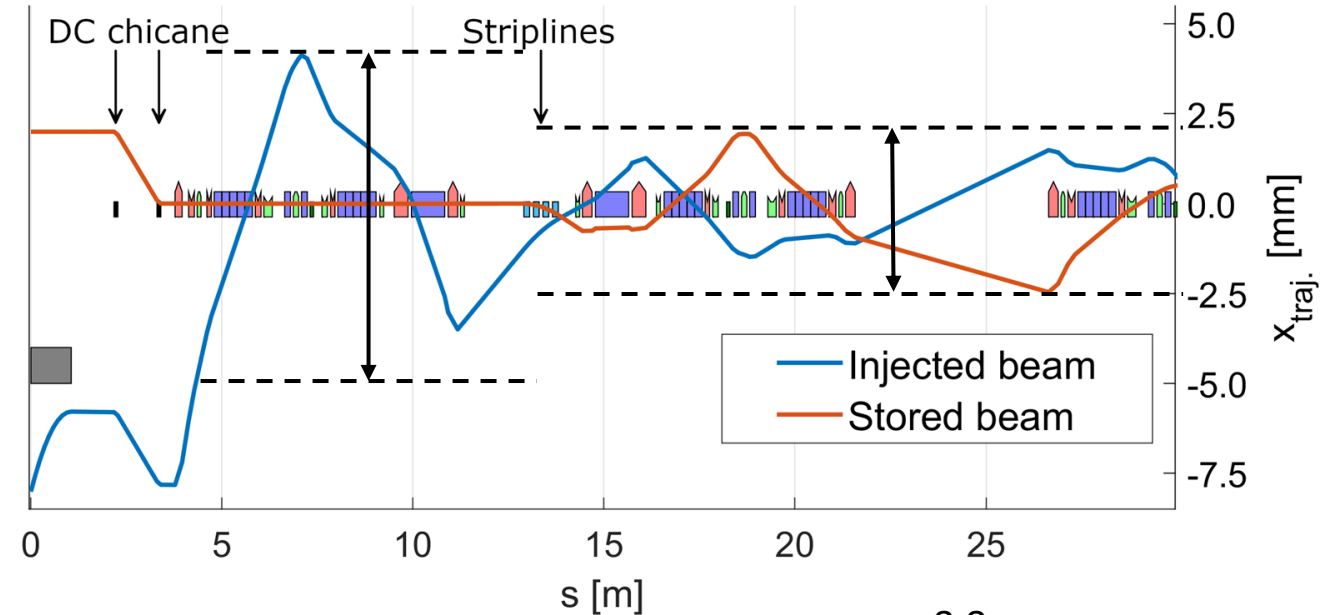

Alternative Injection Scheme: 'Kick-and-Cancel'

'Aperture-sharing'

'Kick-and-Cancel'

Straight I01

Straight K01

Straight I01

Straight K01

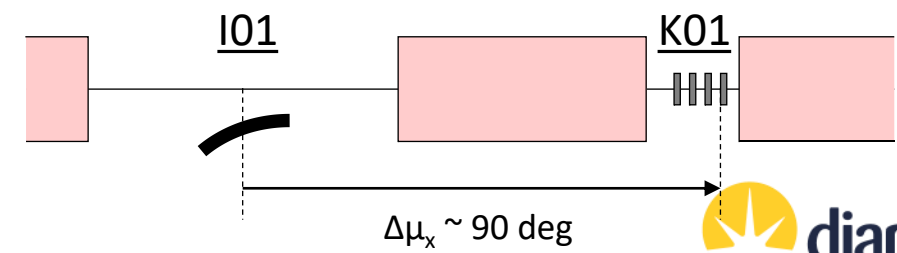
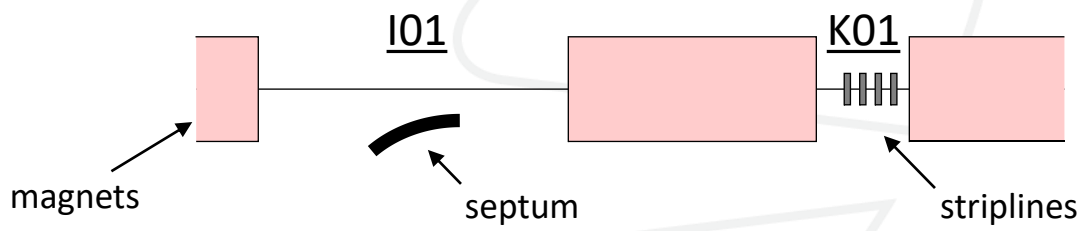
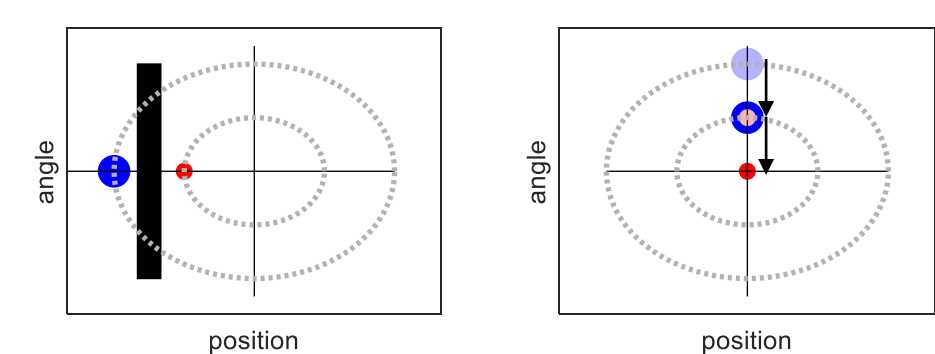
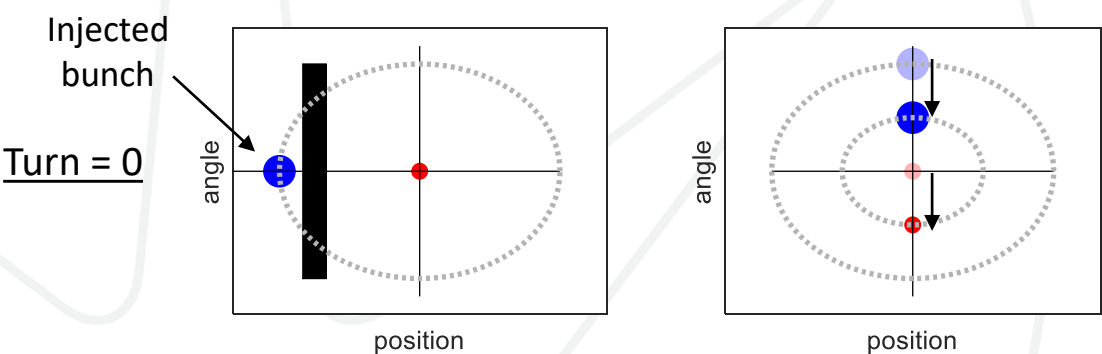
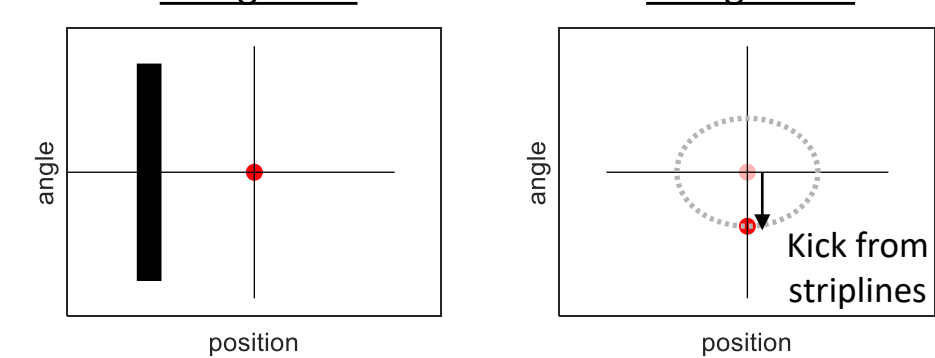
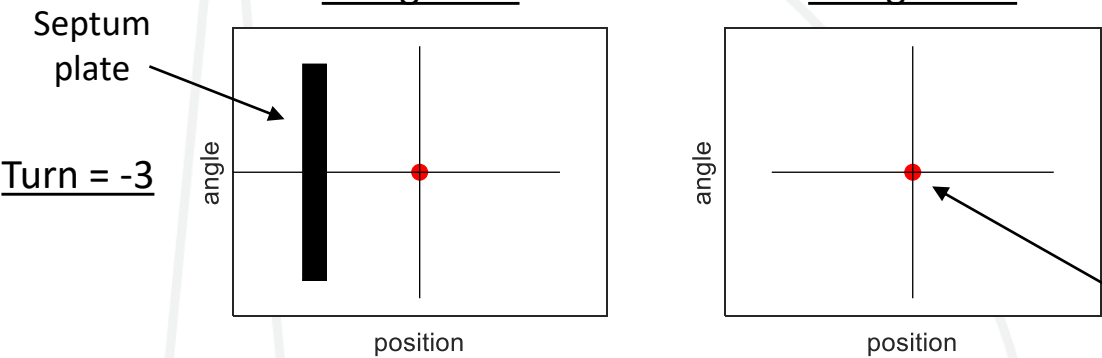

Diamond-II RF Systems

To improve lifetime and combat instabilities, Diamond-II will operate with dual-frequency RF systems

Main RF System

- HOM-damped normal conducting cavities
- More robust and more easily repaired than superconducting cavities
- Smaller footprint
- Releases current RF straight for flagship beamline

Harmonic RF System

- Passive super-conducting 3rd harmonic cavity
- Gives factor ~ 3 -4 bunch lengthening
 - Maximise beam lifetime
 - Reduces intrabeam scattering
 - Alleviate collective instabilities

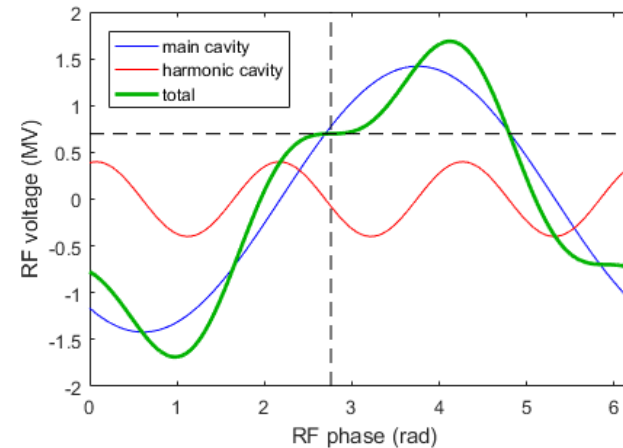
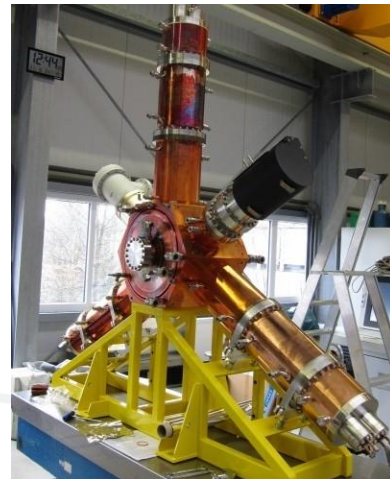
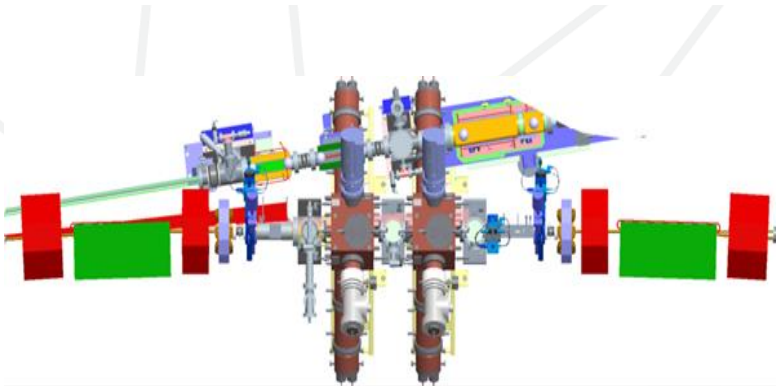

Filling Pattern

A new standard filling pattern is required for Diamond-II

Conflicting requirements:

- Gaps are required in the filling pattern to avoid ion-trapping (longer the better)
- Beam-loading in the main and harmonic RF cavities cause phase-transients to appear along the bunch trains (effect reduces for smaller gaps)

Number of RF buckets reduces from 936 to 934 due to shorter circumference

Diamond Standard Fill

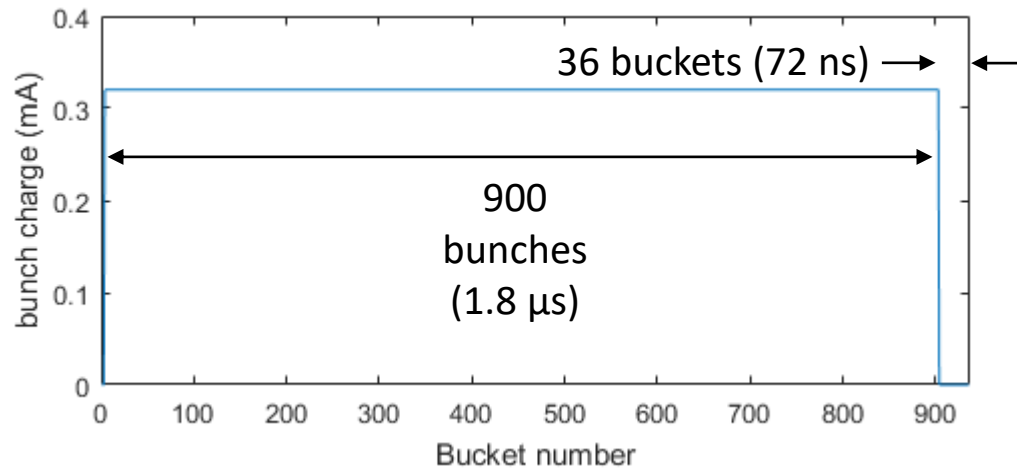

Diamond-II Standard Fill

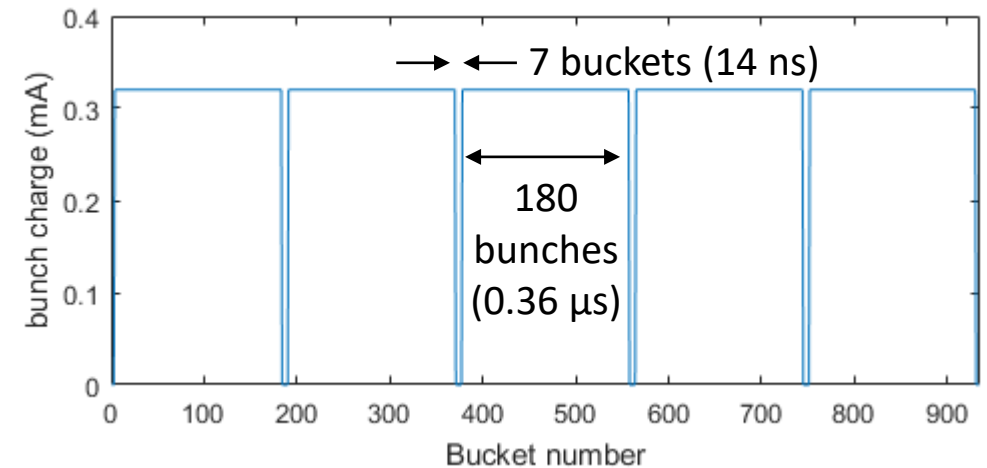

Bunch Profile

Arrival time of bunch centroid

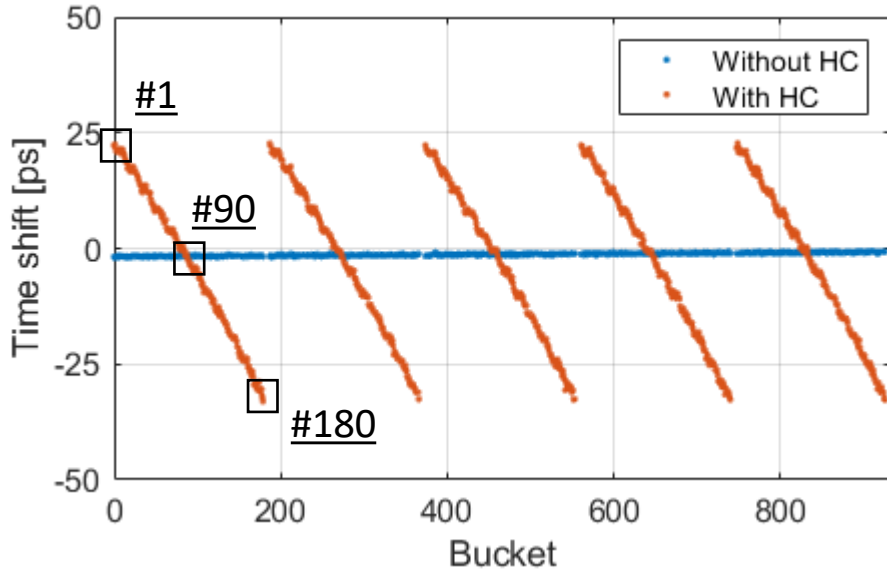

RMS bunch length

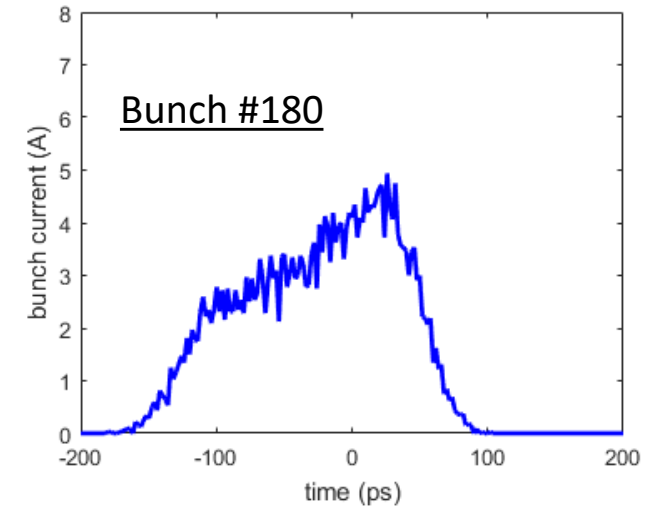
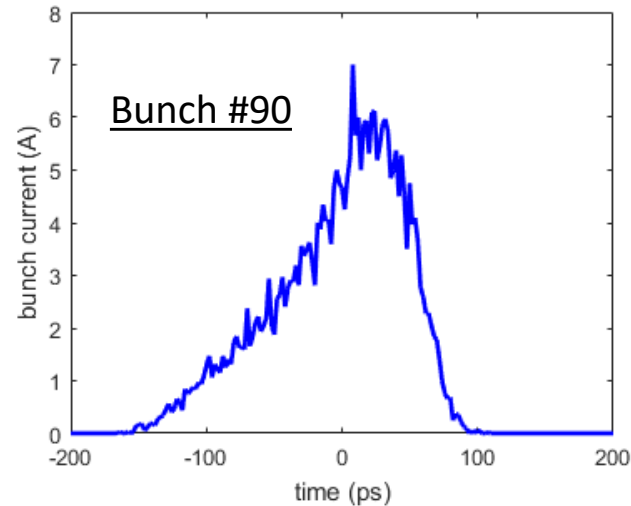
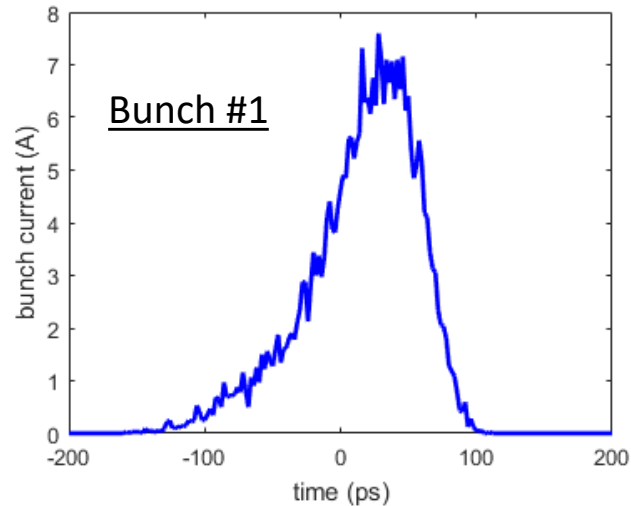
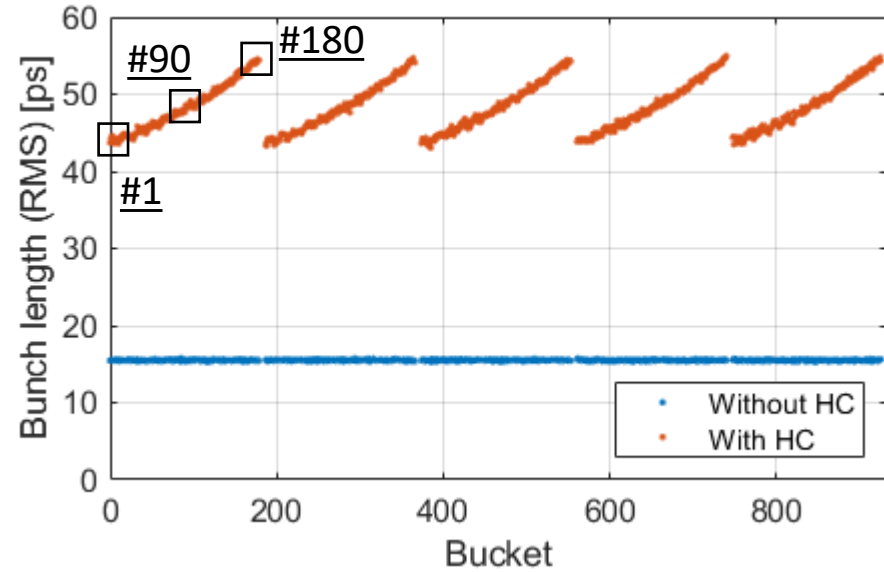

Lifetime

Many processes which can cause particle loss and affect the lifetime. Main two processes:

- Electron-electron scattering within the bunch (Touschek scattering)
- Electron collisions with residual gas molecules (Gas lifetime)

Gas lifetime will be most significant in early commissioning but will improve with time

Touschek component expected to dominate

Harmonic cavity increases lifetime by a factor 3-4 in standard mode

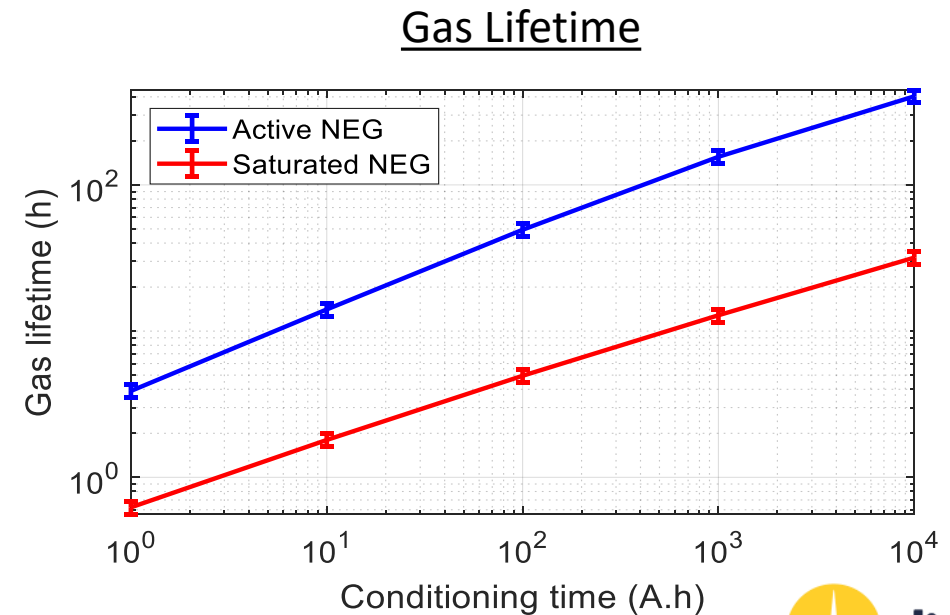
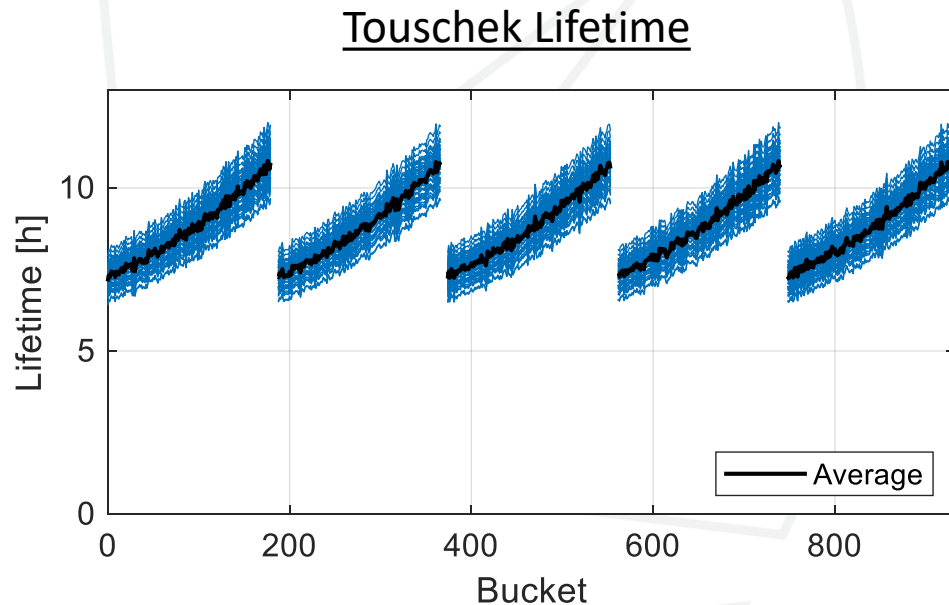

Intra-Beam Scattering

- Electron-electron scattering within the bunch can cause the bunch volume to grow with current
- More important for low emittance rings where the particle density is high
- Damping from the IDs counteracts the growth rate from scattering
- The harmonic cavity also helps to reduce IBS by stretching the bunch and reducing the particle density
- Once IDs and HC are considered, growth from IBS is $\sim 1\text{-}3\%$ at the nominal bunch current

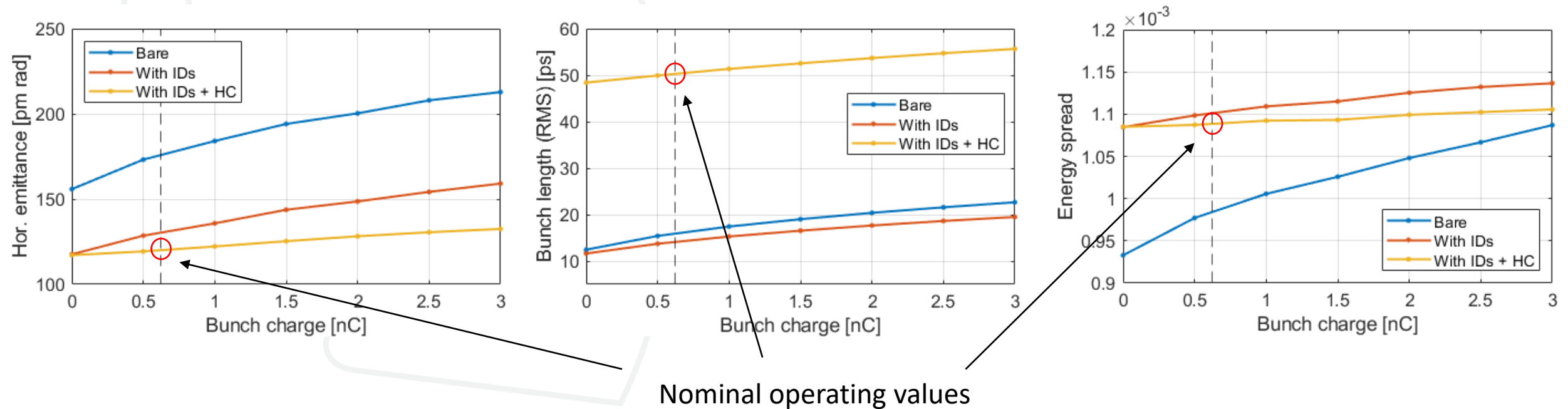

Conclusions

Diamond-II storage ring designed to combine a low emittance with high capacity for beamlines

Only possible thanks to significant advances in accelerator technology, in particular:

- High-field / permanent magnet technology
- NEG coating for narrow vacuum chambers
- Insertion device design and technology
- Engineering: magnet and girder alignment / stability

Many challenges associated with the design:

- Cross-talk effects between magnets in compact lattices
- Collective effects from smaller vacuum chambers
- Collimation to protect permanent magnets, IDs, in-tunnel electronics
- Feedbacks and feed-forward schemes to stabilise machine performance
- ...

Acknowledgements

Accelerator Physics Team:

Neven Blaskovic Kraljevic, Hung-Chun Chao, Richard Fielder, Hossein Ghasem, Anusorn Lueangaramwong, Shaun Preston, Dmitrii Rabusov, Beni Singh, Siwei Wang

Past members:

Marco Apollonio, Riccardo Bartolini, Johan Bengtsson, Riyasat Husain, Jonas Kallestrup, Maxim Korostelev, Teresia Olsson

Thanks for listening!