



Science and
Technology
Facilities Council

ASTeC

*Making a brighter future through
advanced accelerators*

Update on CLARA Facility at Daresbury Laboratory

Deepa Angal-Kalinin on behalf of the CLARA
Team

ASTeC, STFC Daresbury Laboratory and The Cockcroft
Institute

IoP PAB Conference, 30th June 2023, Glasgow

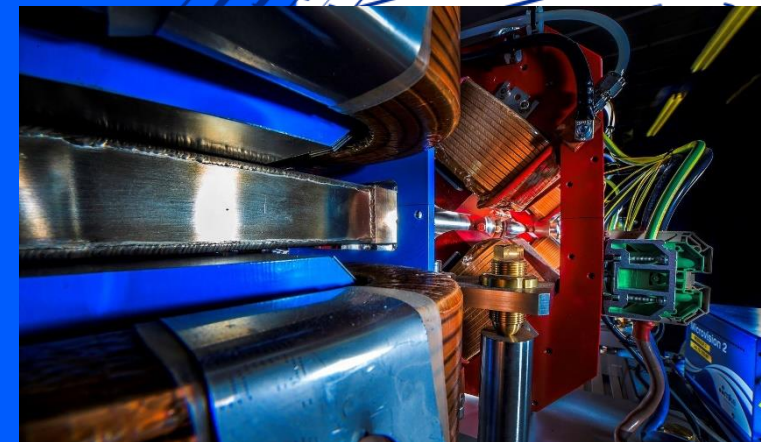

Outline

- Introduction
- High Repetition Rate Gun Commissioning
- Current Status
- Plans

Compact Linear Accelerator for Research and Applications

Ambition: UK Next Generation X-ray FEL with World Leading Capabilities

- Addressing many scientific and technology challenges for future large scale facility
 - Proving new FEL concepts
 - Developing UK skills
 - Testing new accelerator & FEL technologies
 - **Ramping up from 1st October 2022 - UK XFEL CDOA funded for 3 years (Neil Thompson's talk)**
- Provide an electron beam research facility for
 - Accelerator R&D
 - Industrial & healthcare applications
 - **Strong demand – oversubscribed by factor of 2**
- Upgrade to VELA Photoinjector based test facility.
- CDR published in 2013.
- Project divided in three phases – funding availability



CLARA Phase1 & VELA

50 MeV, 250 pC at 10 Hz (2017)

User exploitation from CLARA FE to VELA line (since 2018 till April 2022)

HRRG commissioned on VELA line (March 2023) ready to swap guns.

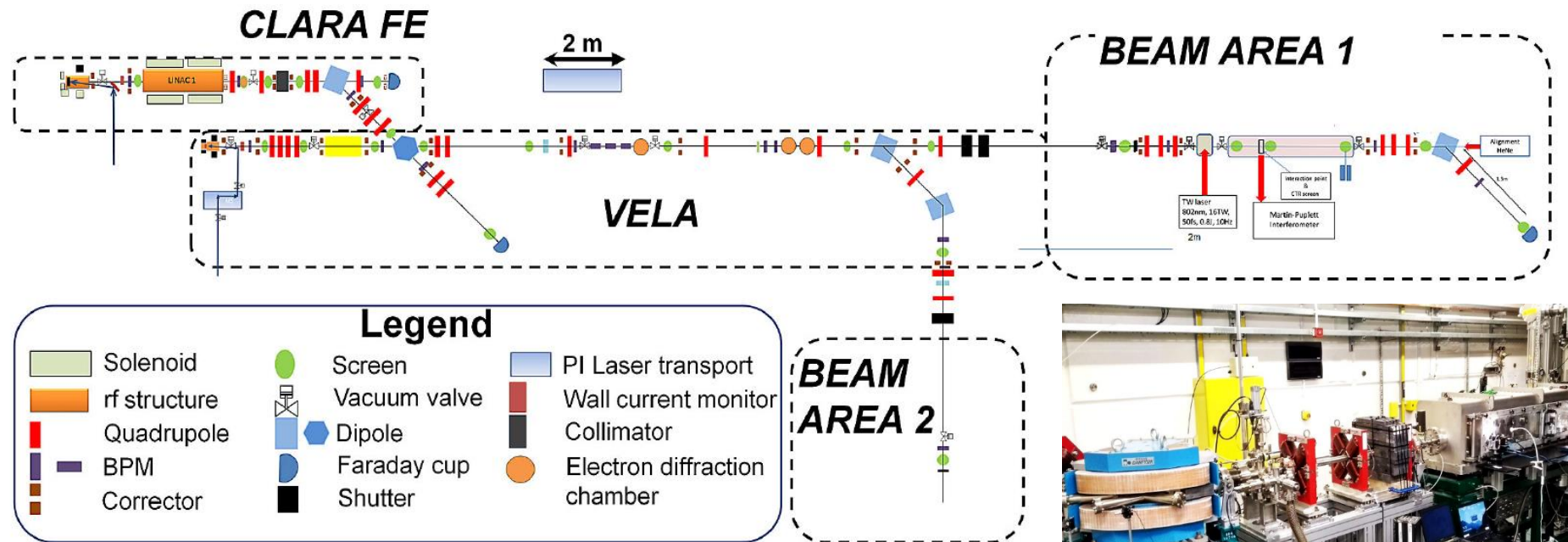
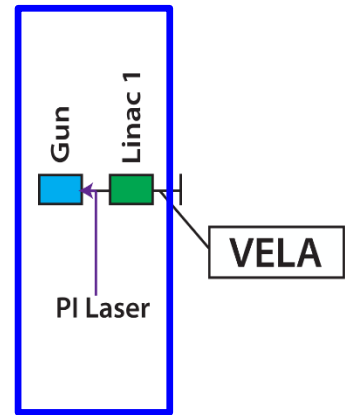

D. Angal-Kalinin *et al.*, Phys. Rev. Accel. Beams **23**, 044801

CLARA Phase 1- Experimental Areas

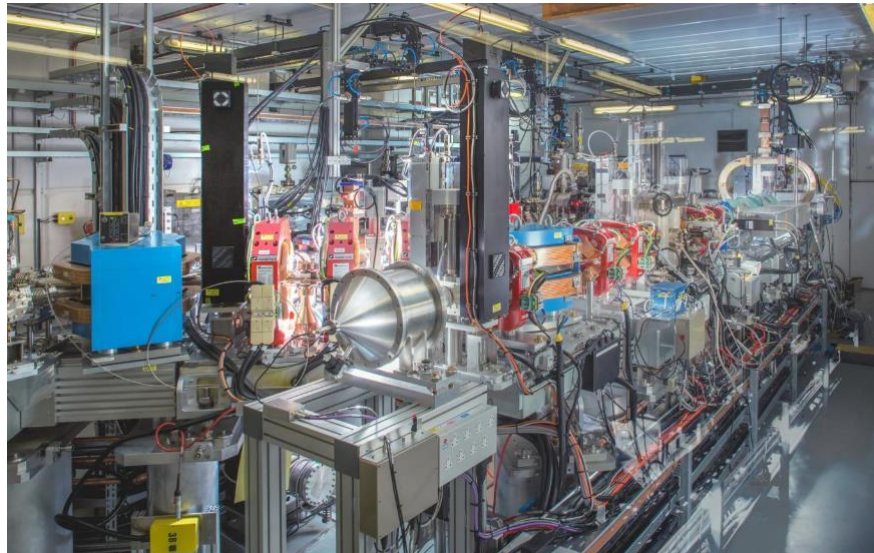
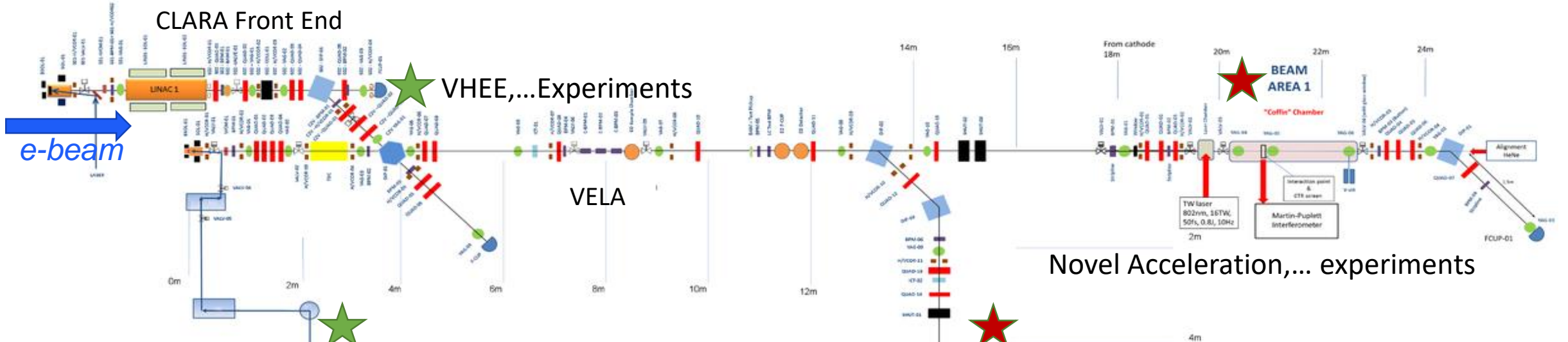

250 MeV, ASSEMBLED OFFLINE, Partially installed whilst operating Phase 1.

Shutdown (March – October 2023) for installation in Phase 1 area.

Includes dedicated 250 MeV beamline (FEBE) for novel experiments (approved in 2019 ahead of Phase 3) and 100 TW laser in FEBE hutch (funding approved FY23/24, FY24/25).

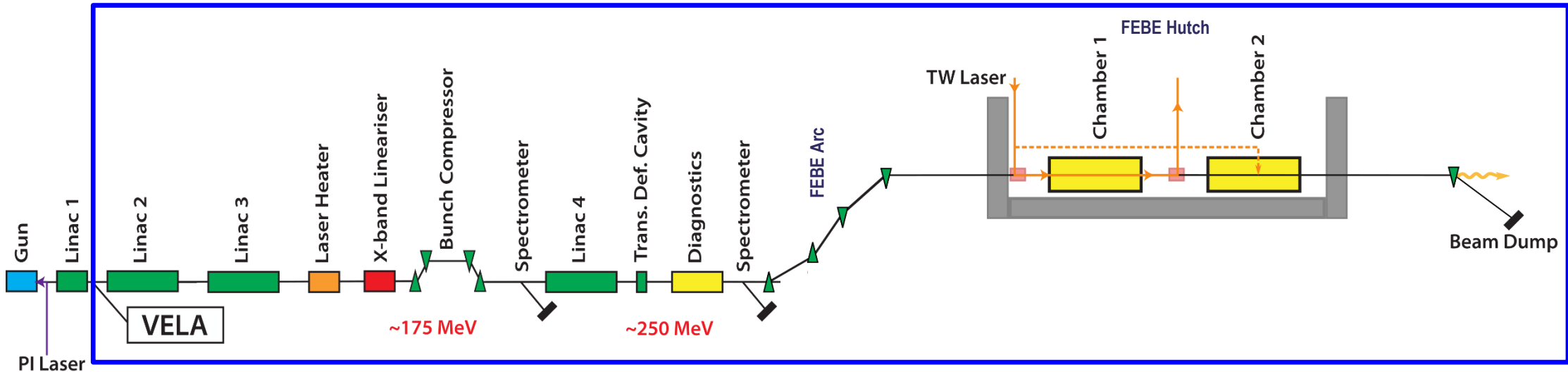

CLARA Phase3

100 nm FEL

NOT YET FUNDED. Decision tied to UK XFEL.
Space is reserved.

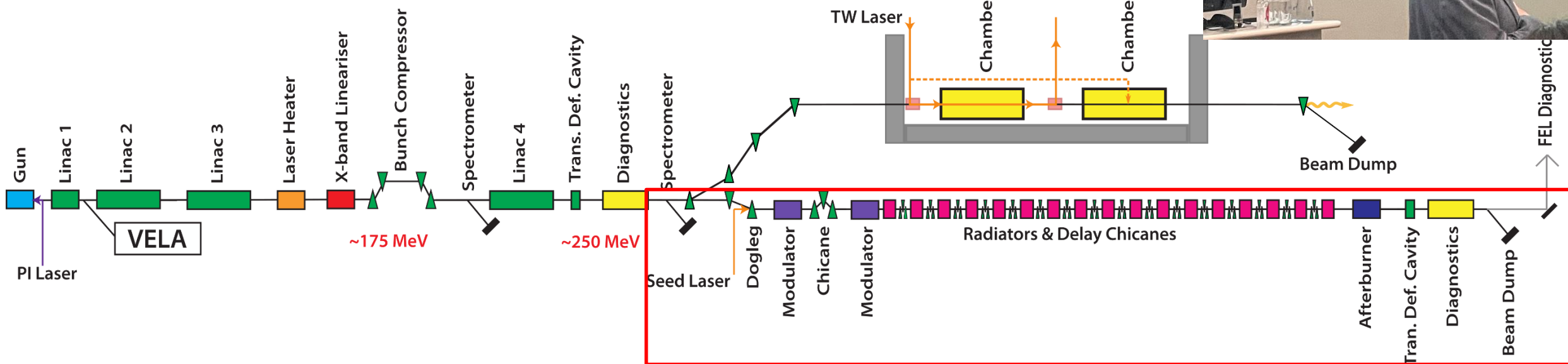
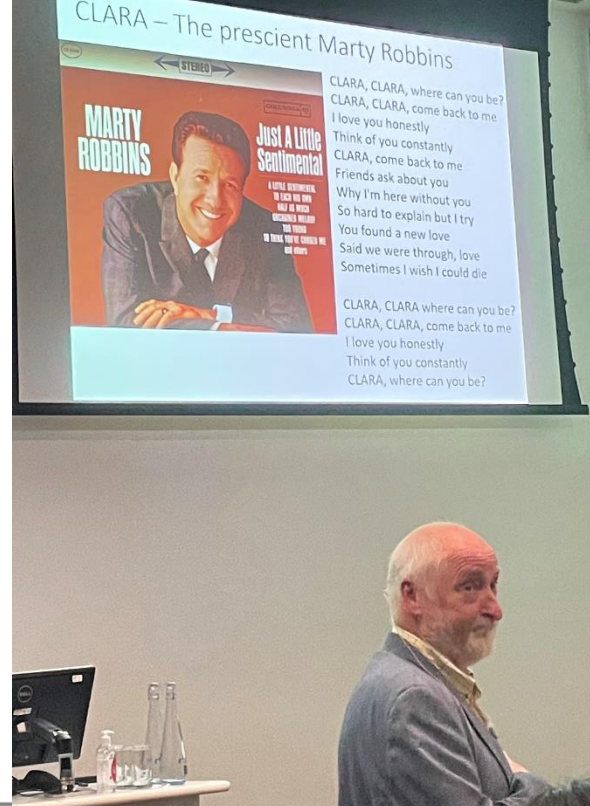

High Repetition Rate (400 Hz) Gun

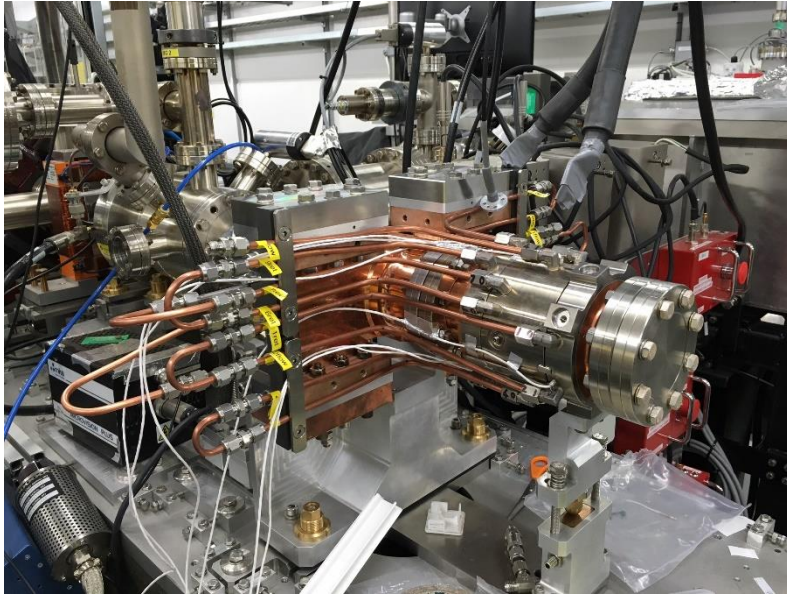

- 1.5-cell S-band High Repetition Rate Gun (HRRG) designed by STFC/CI/INR collaboration.
- CLARA specification is 100 Hz, 400 Hz for technology demonstration. Installed on VELA line for commissioning.
- Fitted with vacuum load-lock system which allows to transport and swap cathodes without breaking vacuum.
- Time allocated for conditioning after user run from April'22.
- Auto-conditioning script developed & used for unmanned conditioning.

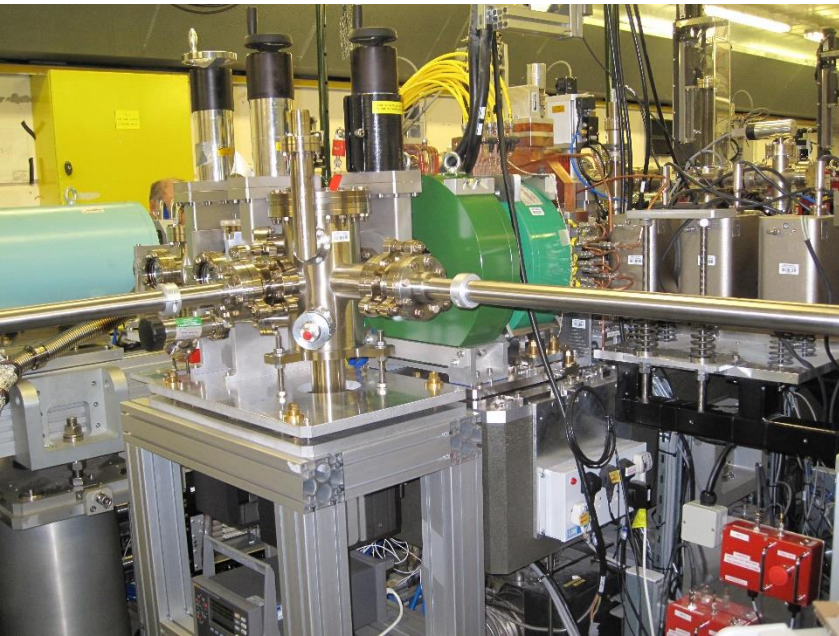

0/06/2023

HRRG Beam Commissioning

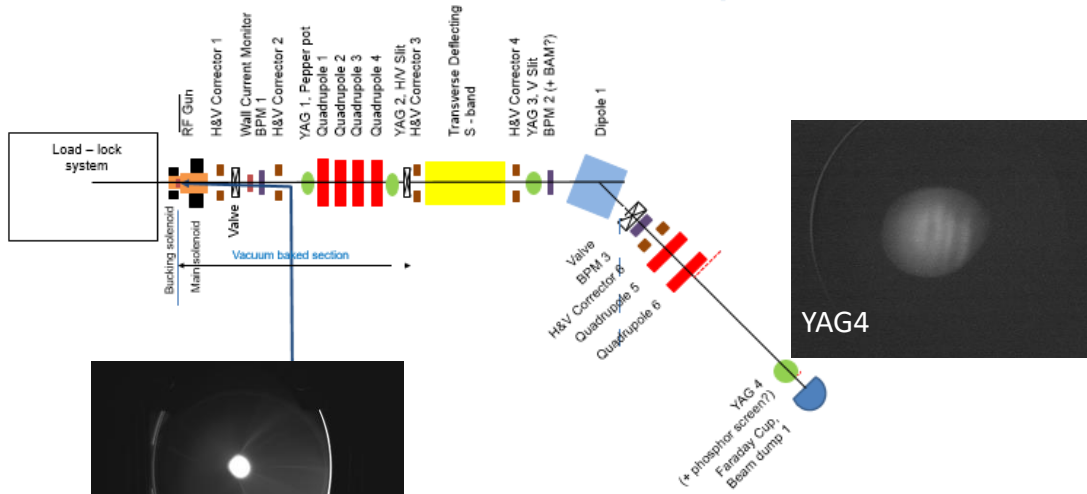

- Demonstrated 1st beam from HRRG in March 2023. Due to problems with waveguide and issues with the modulator to operate at higher than 100 Hz, RF conditioning took long time.
- 1.25us pulse length, 5.2MW klystron, 2.6MW probe, 3 MeV/c beam momentum
- 100 pC on F-cup (stopped at 100pC and didn't turn laser up higher)
- Successful demonstration of first in-house designed RF gun to swap the gun on CLARA line. Sufficient time has been set in the commissioning plan to demonstrate design specifications.

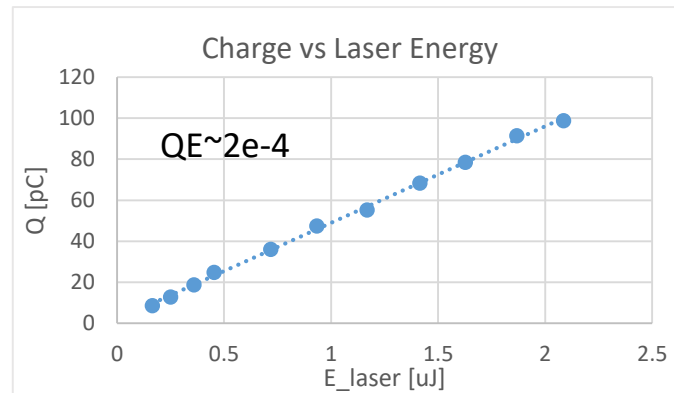
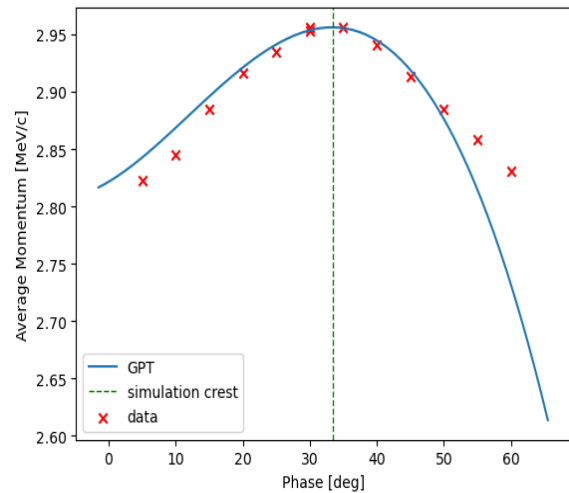

FEBE Experimental Hutch

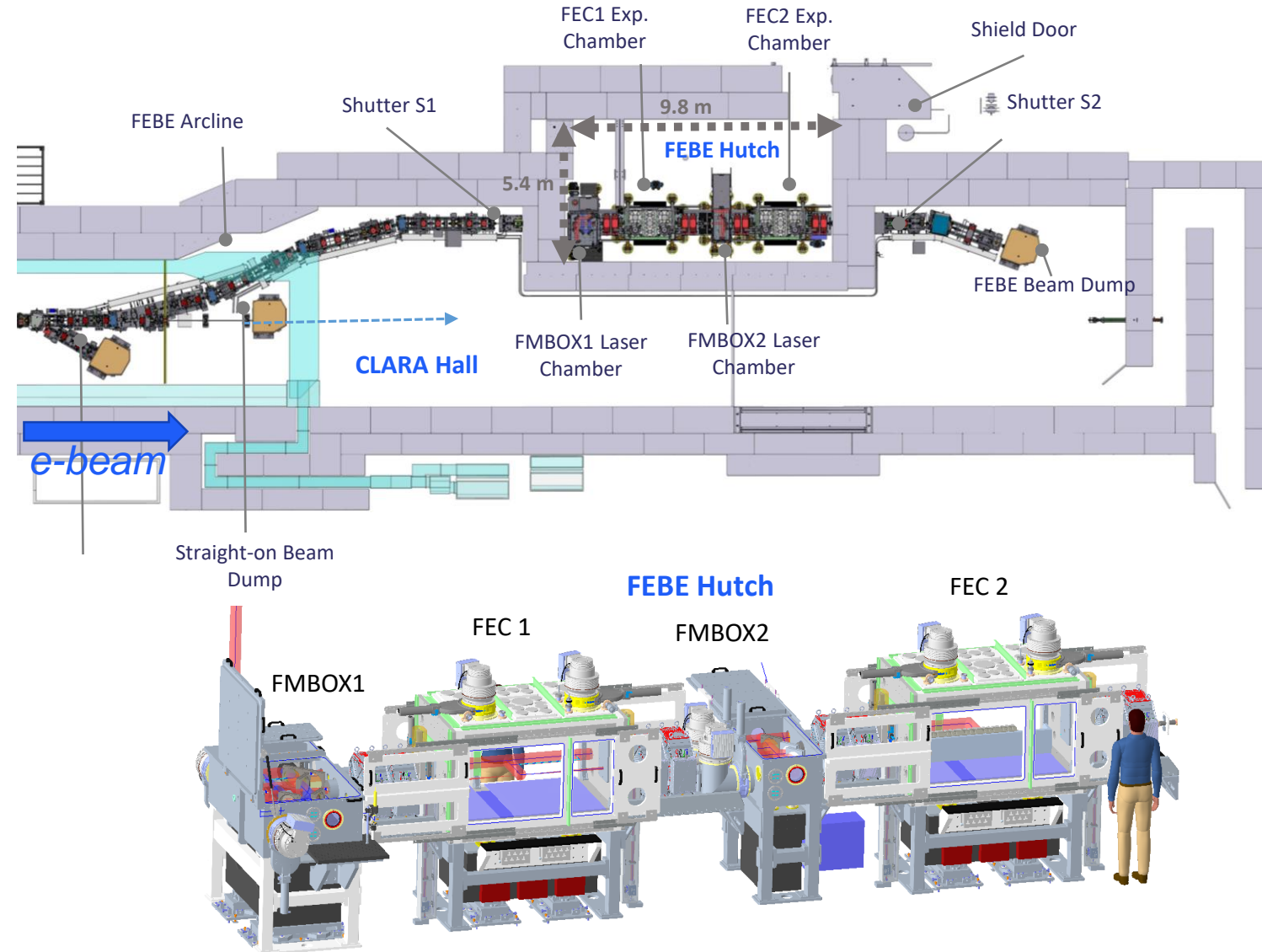

Offered parameters to evolve
'Day 1' → *Nominal* → *R&D*

Parameter	High charge	Low charge
Energy [MeV]	250	250
Charge [pC]	250	5
RMS t [fs]	100 (50)	50 (≤ 50)
σ_E/E [%]	<5 (1)	<1 (<1)
RMS x [μm]	100 (50)	20 (1)
RMS y [μm]	100 (50)	20 (1)
$\epsilon_N x$ @ 250 MeV [μm]	5 (<5)	2 (1)
$\epsilon_N y$ @ 250 MeV [μm]	5 (<1)	2 (<1)

To be confirmed through measurement using appropriate diagnostics (and R&D)

CLARA can combine electrons with a **120 TW, 5 Hz** laser (Arco, Amplitude).

The laser is housed immediately on top of the FEBE hutch, with light directed to target via a shielded periscope.

Installation is scheduled for the second half of 2024, with the laser ready for exploitation at the beginning of 2025.

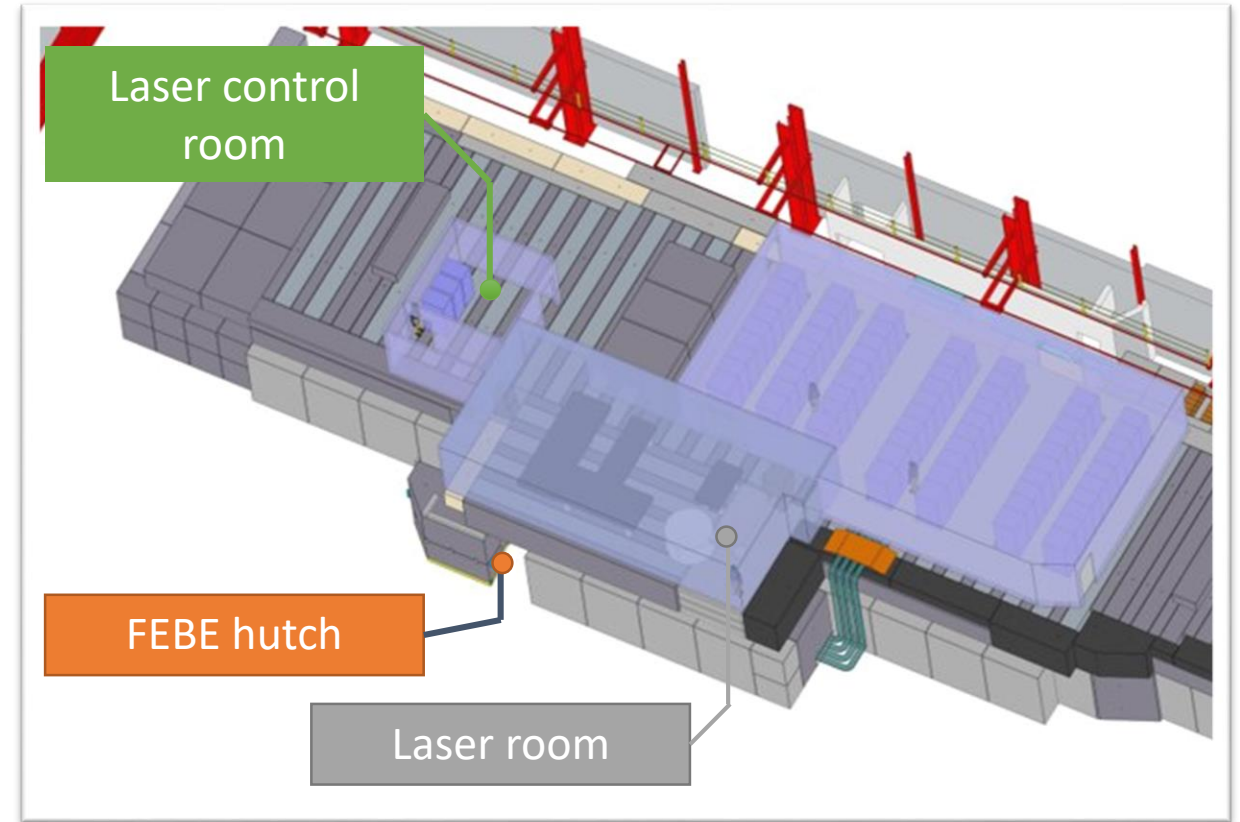

FEBE Hutch & Chambers

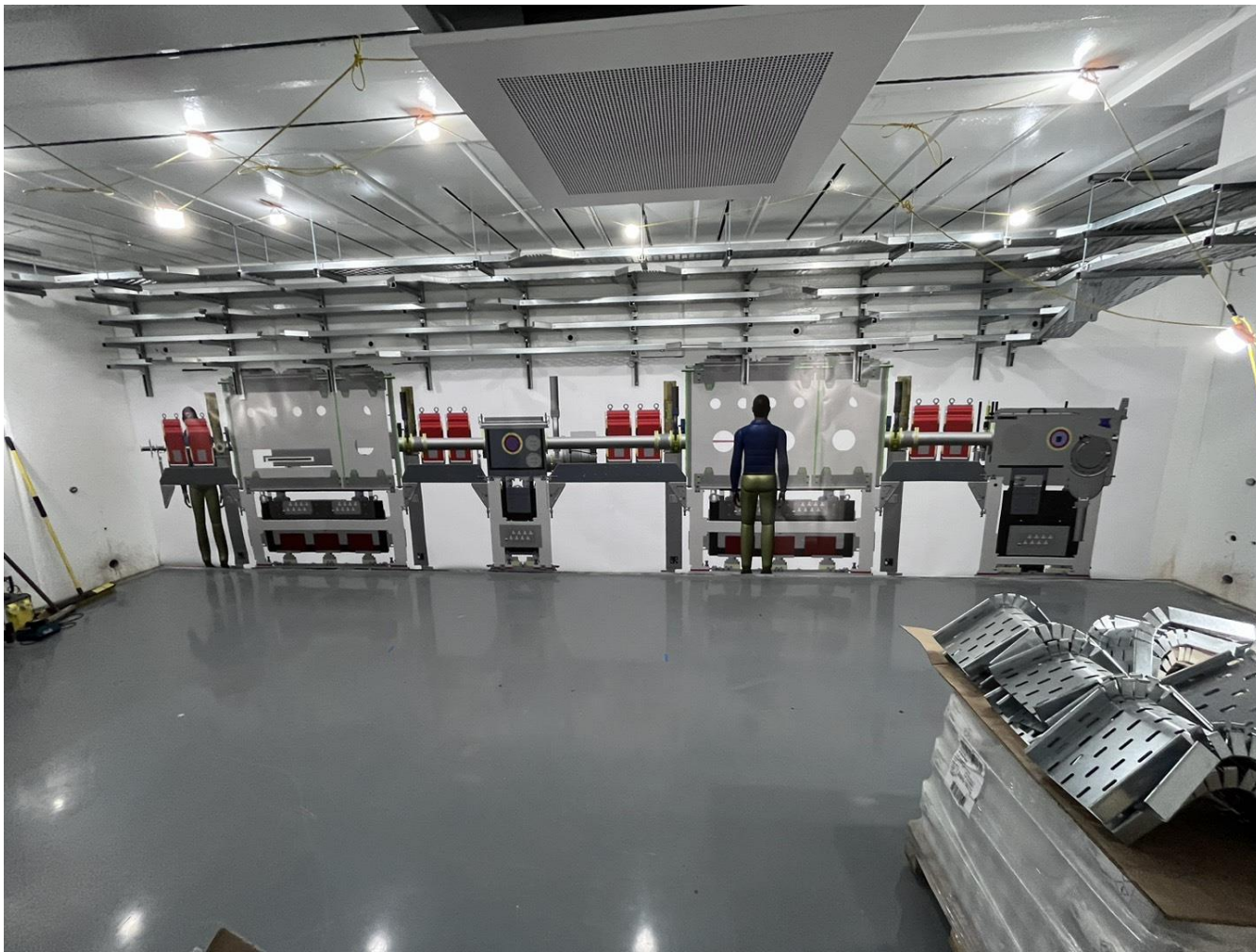

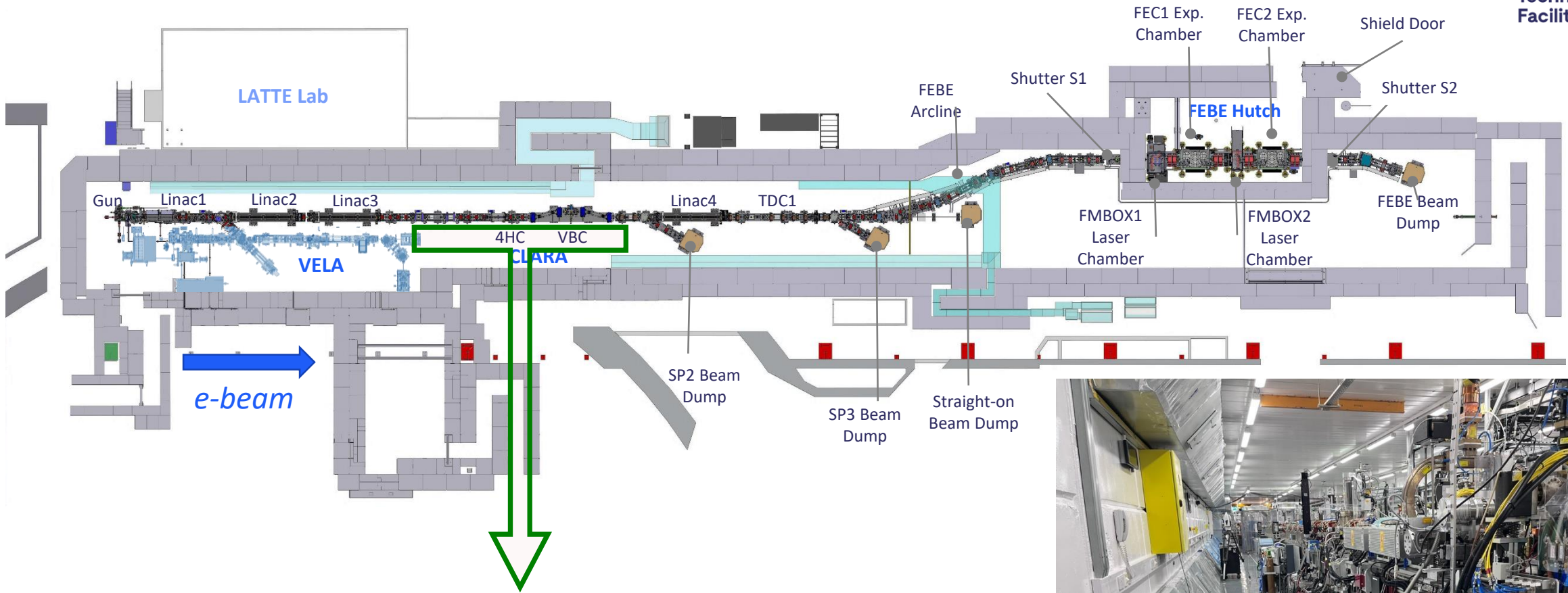

Beam Area1 beamline and wall removed



Preparation of Installation in Phase 1 Area (May 2023)

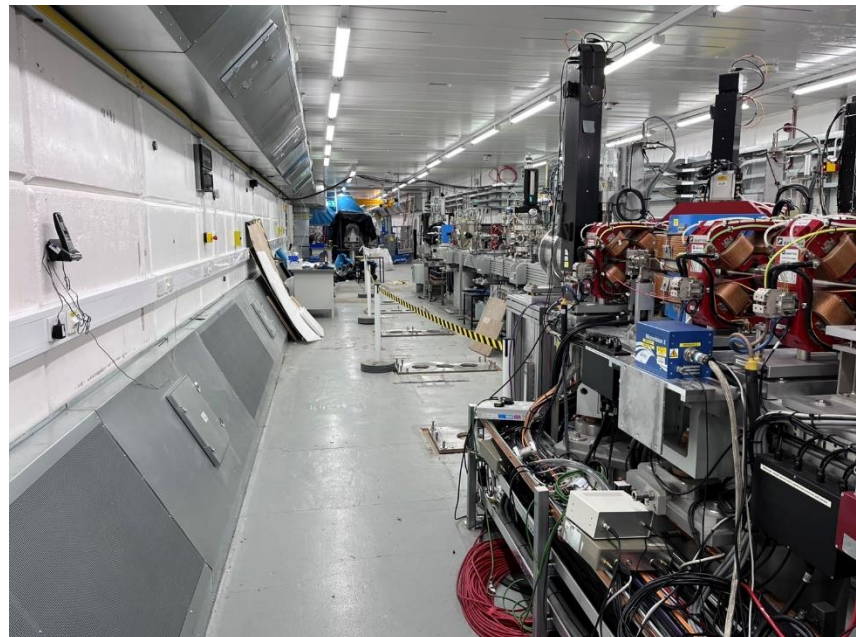

0/06/2023

Installation



Installation

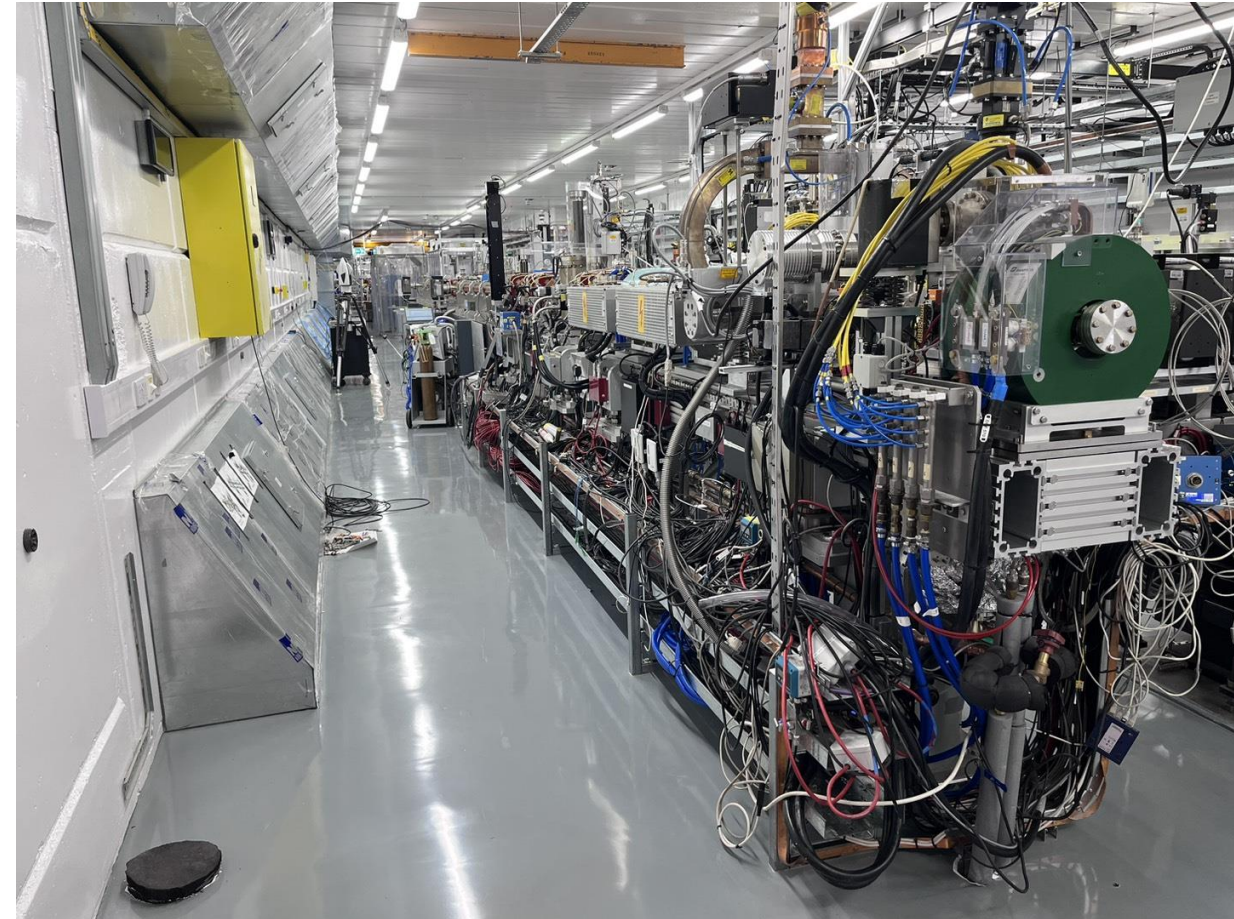

Plans

- Phase 2 technical commissioning followed by beam commissioning plan will run from November 2023 to February 2024
- Goal is to confirm “Day 1” parameters experimentally.
- Beam commissioning software tools (“Apps”) development currently ongoing using Virtual machine.
- Expect user exploitation programme start early 2025.

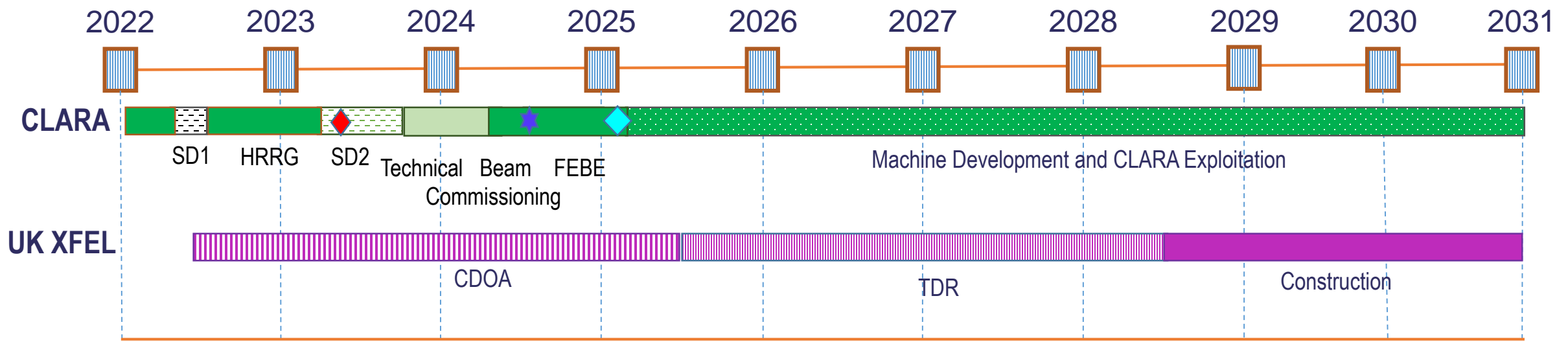

◆ FEBE Laser contract begins
 ★ FEBE Exploitation kick off meeting
 ◆ FEBE Laser ready for exploitation
 SD1 Shutdown – Gun RF swap
 SD2 Shutdown – Phase 2 installation

Thank you!

