



# Search for Dark Matter with the PICO-500 Experiment

Guillaume Giroux

Queen's University, Kingston, Ontario, Canada

IPP 50<sup>th</sup> Anniversary Symposium



**PICO**



**NORTHWESTERN UNIVERSITY**  
C.E. Dahl, M. Jin, J. Zhang



**PennState**  
S. Priya, Y. Yan



**ČESKÉ VYSOKÉ UČENÍ TECHNICKÉ V PRAZE**  
R. Filgas, I. Stekl



**UNIVERSITAT POLITÈCNICA DE VALÈNCIA**  
M. Ardid, M. Bou-Cabo, I. Felis



**Drexel UNIVERSITY**  
M. Bressler, R. Neilson



**IF**  
F. Flores, A. Gonzalez, E. Noriega-Benitez, E. Vázquez-Jáuregui



**SNOLAB**  
I. Lawson



**Fermilab**  
P.S. Cooper, M. Crisler, W.H. Lippincott, A. Sonnenschein



**Northeastern UNIVERSITY**  
O. Harris



**Queens UNIVERSITY**  
B. Broerman, G. Cao, K. Clark, G. Giroux, C. Hardy, H. Herrera, C. Moore, A. Noble, T. Sullivan



**KICP**  
Kavli Institute for Cosmological Physics at The University of Chicago  
D. Baxter, J.I. Collar, J. Fuentes



**UNIVERSITY OF ALBERTA**  
C. Coutu, N.A. Cruz-Venegas, S. Fallows, T. Kozynets, C. Krauss, S. Pal, M.-C. Piro, W. Woodley



**INDIANA UNIVERSITY SOUTH BEND**  
K. Allen, E. Behnke, I. Levine, N. Walkowski, A. Weesner



**Université de Montréal**  
S. Chen, M. Laurin, J.-P. Martin, A.E. Robinson, N. Starinski, D. Tiwari, V. Zacek, C. Wen Chao



**Pacific Northwest NATIONAL LABORATORY**  
I. Arnquist, T. Grimes, B. Hackett, A. Hagen, C.M. Jackson, K. Kadooka, B. Loer



**Laurentian University Université Laurentienne**  
J. Farine, A. Le Blanc, T. Hillier, C. Licciardi, O. Scallon, U. Wichoski

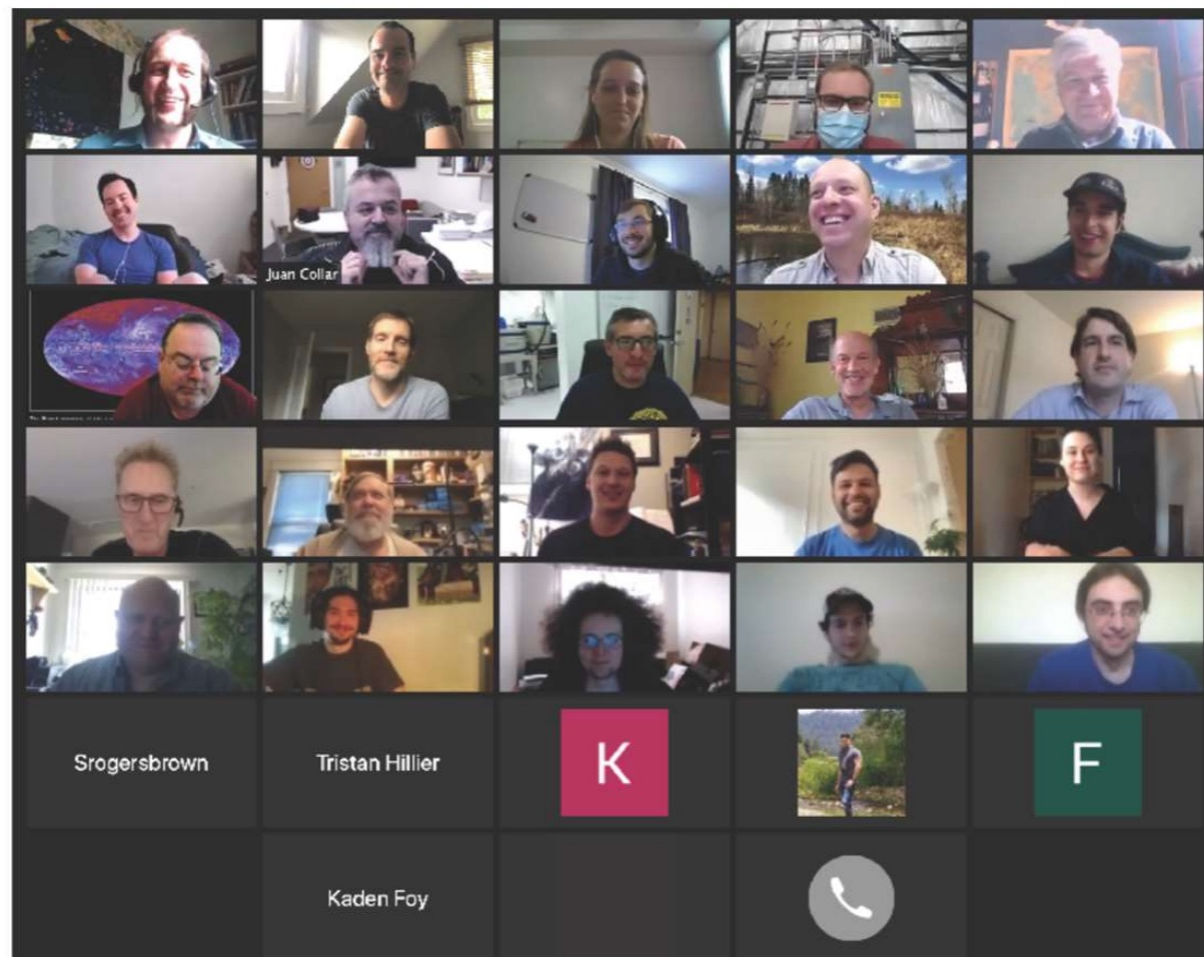

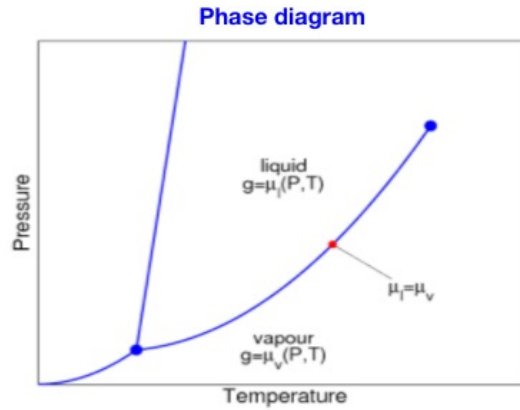

15 Institutions (4 in Canada) and 66 collaboration members

# The PICO Bubble Chamber

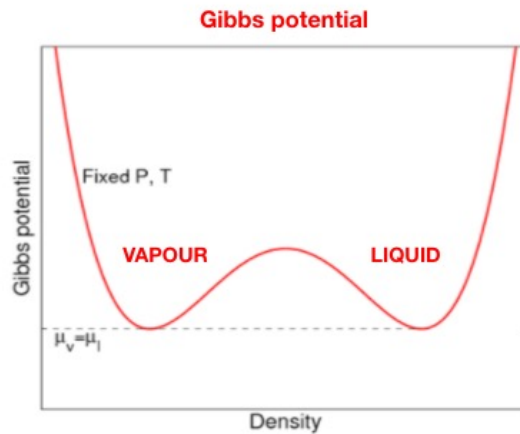

On the saturation curve, two minima exist in the Gibbs potential



Vapour and liquid phase coexist

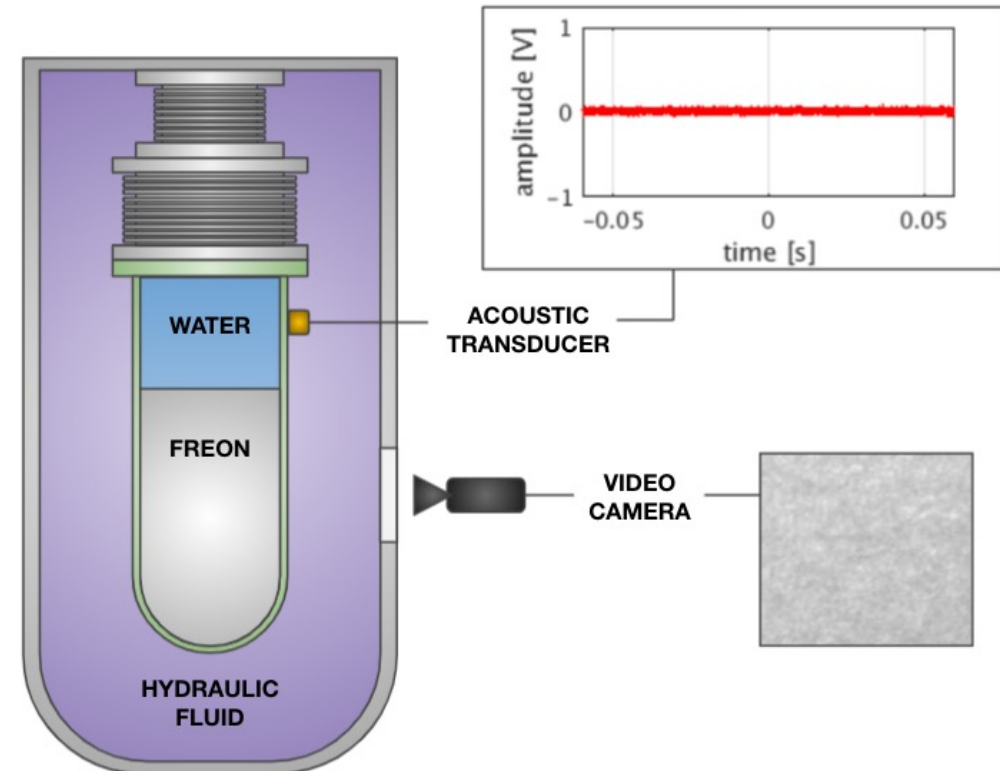

# The PICO Bubble Chamber

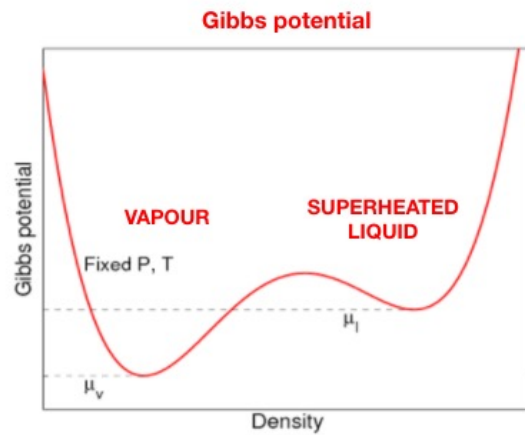
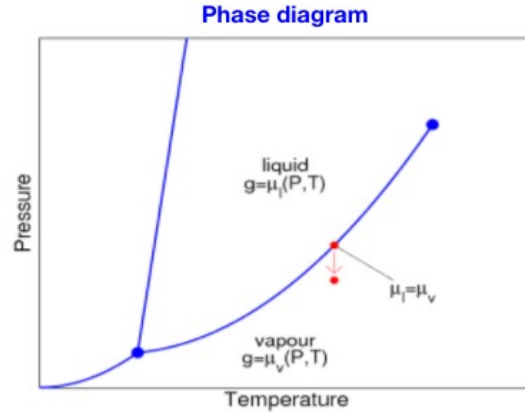

If the pressure is lowered, the Gibbs potential is modified

Still two minima, but one is a metastable state: **superheated liquid**

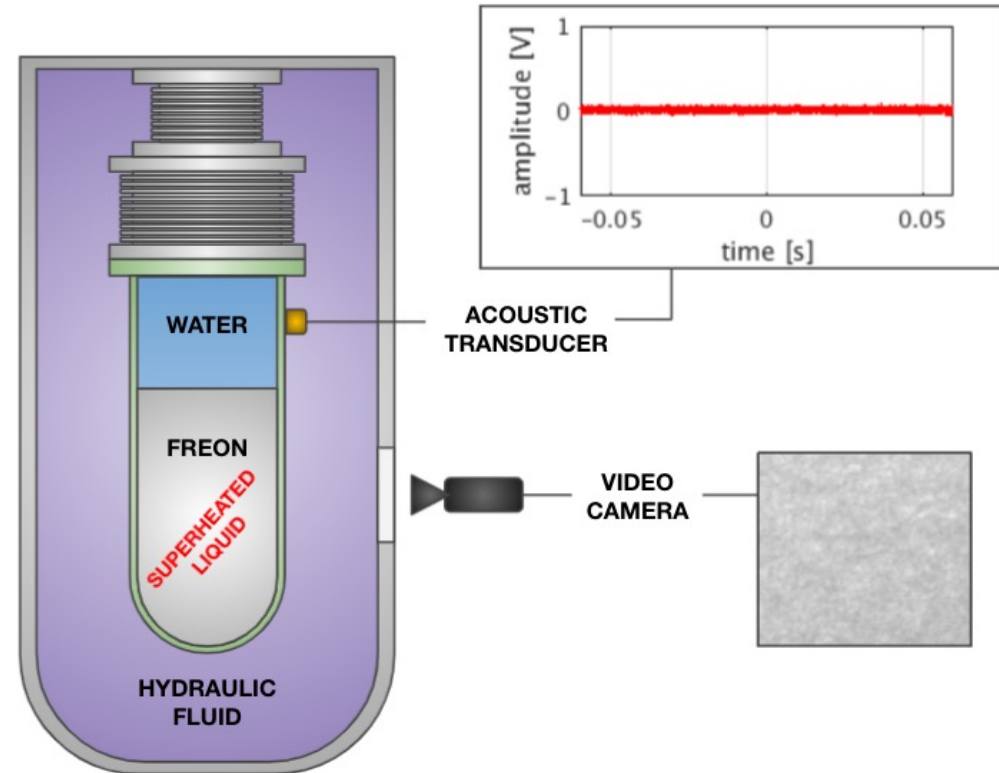

# The PICO Bubble Chamber

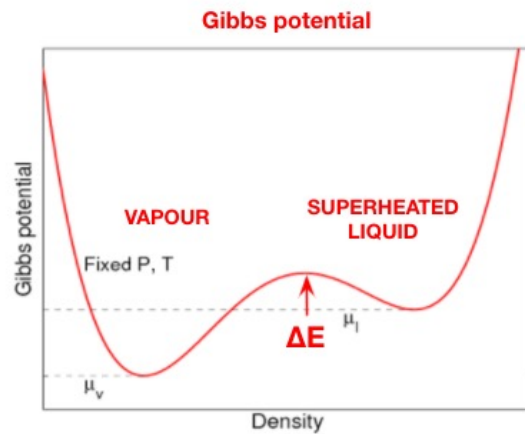
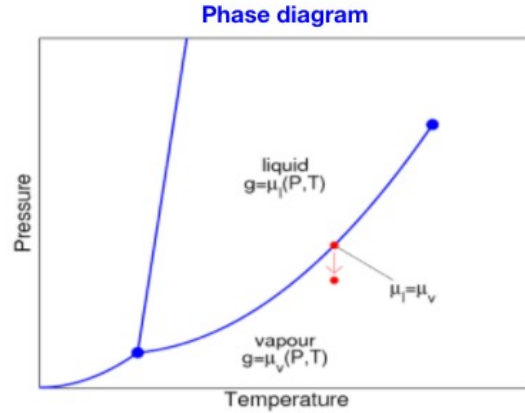

If the pressure is lowered, the Gibbs potential is modified

Still two minima, but one is a metastable state: **superheated liquid**

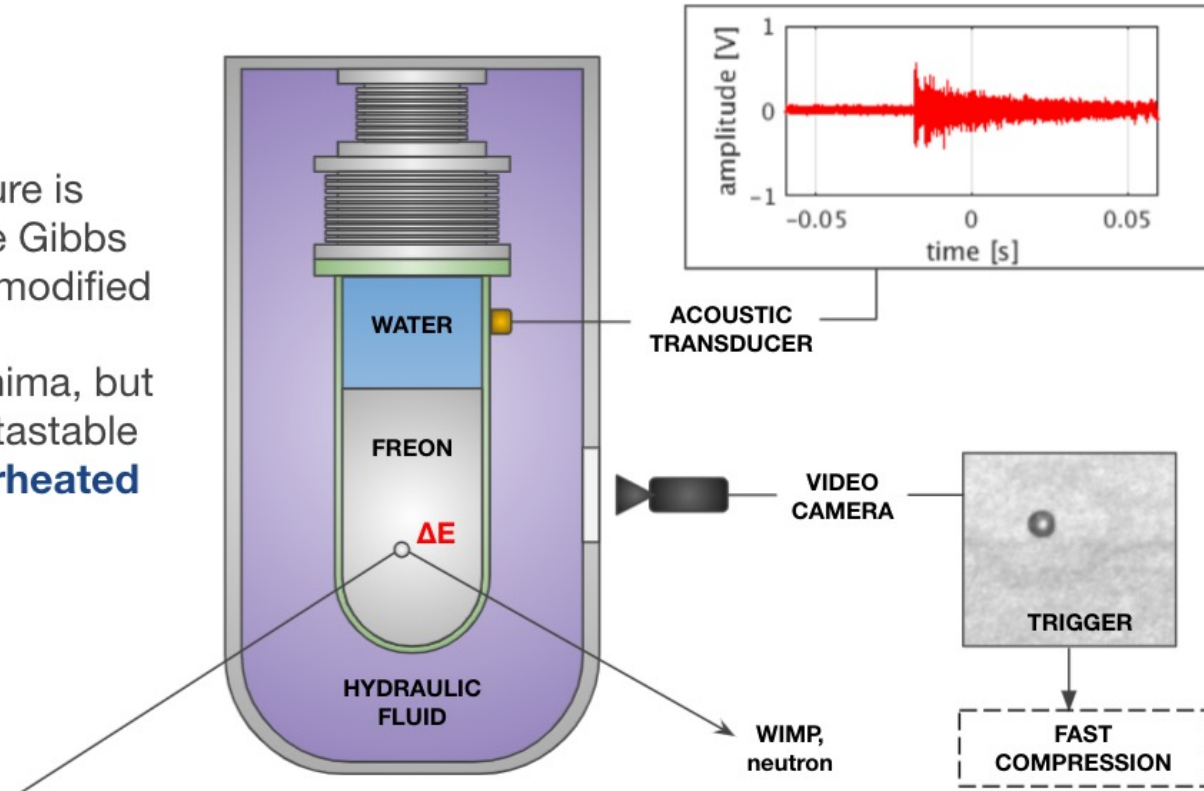

# The PICO Bubble Chamber

- Filled with fluorine rich targets WIMP-proton SD cross-section is enhanced
- Low threshold ( $\sim 1$  keV)
- Background Control
  - Nucleation from electron-recoil suppressed ( $\sim 10^{-9}$  at 3 KeV<sub>nr</sub> threshold)
  - Acoustic discrimination of alpha decays
  - Fast neutron scattering largely vetoed thanks to multiple site nucleation

Neutron multiple scatter

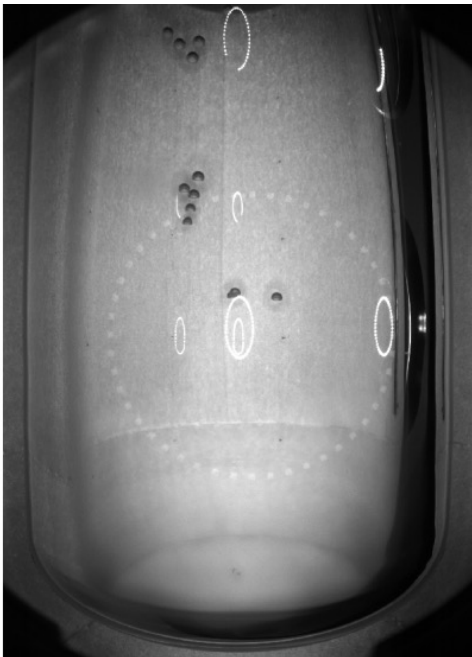

Alpha/recoil acoustic discrimination  
[Phys. Rev. D \*\*100\*\*, 052001 \(2019\)](#)

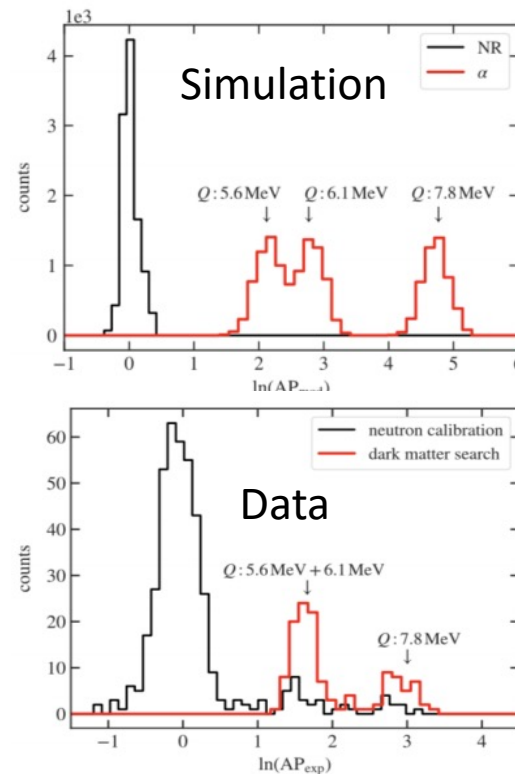

Electron recoil nucleation probability  
[Phys. Rev. D \*\*100\*\*, 082006 \(2019\)](#)

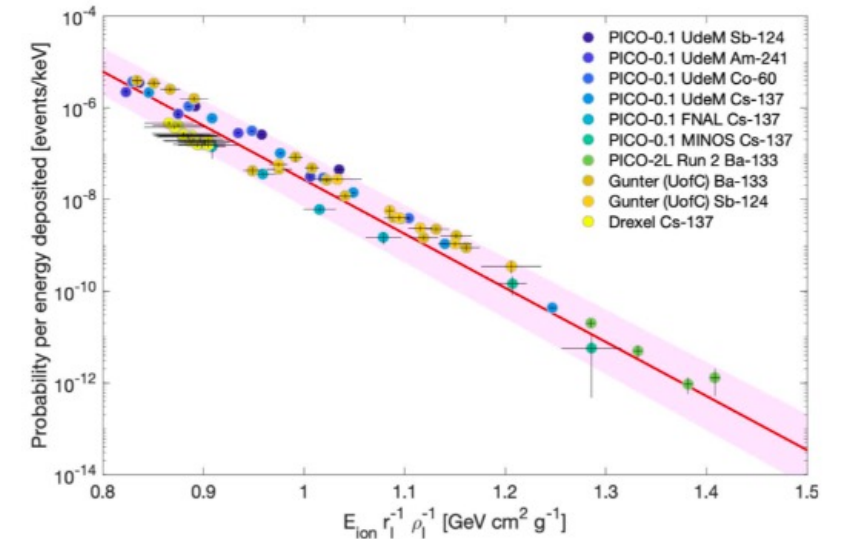

# Nuclear recoil nucleation efficiency

[arXiv:2205.05771](https://arxiv.org/abs/2205.05771) [physics.ins-det]

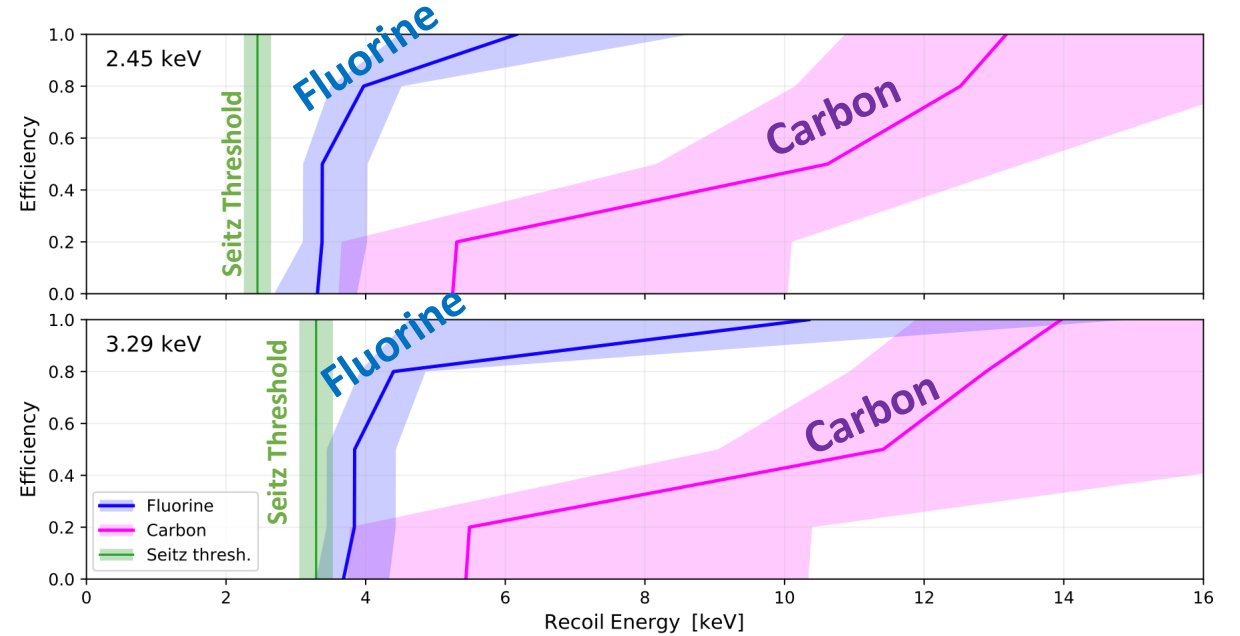
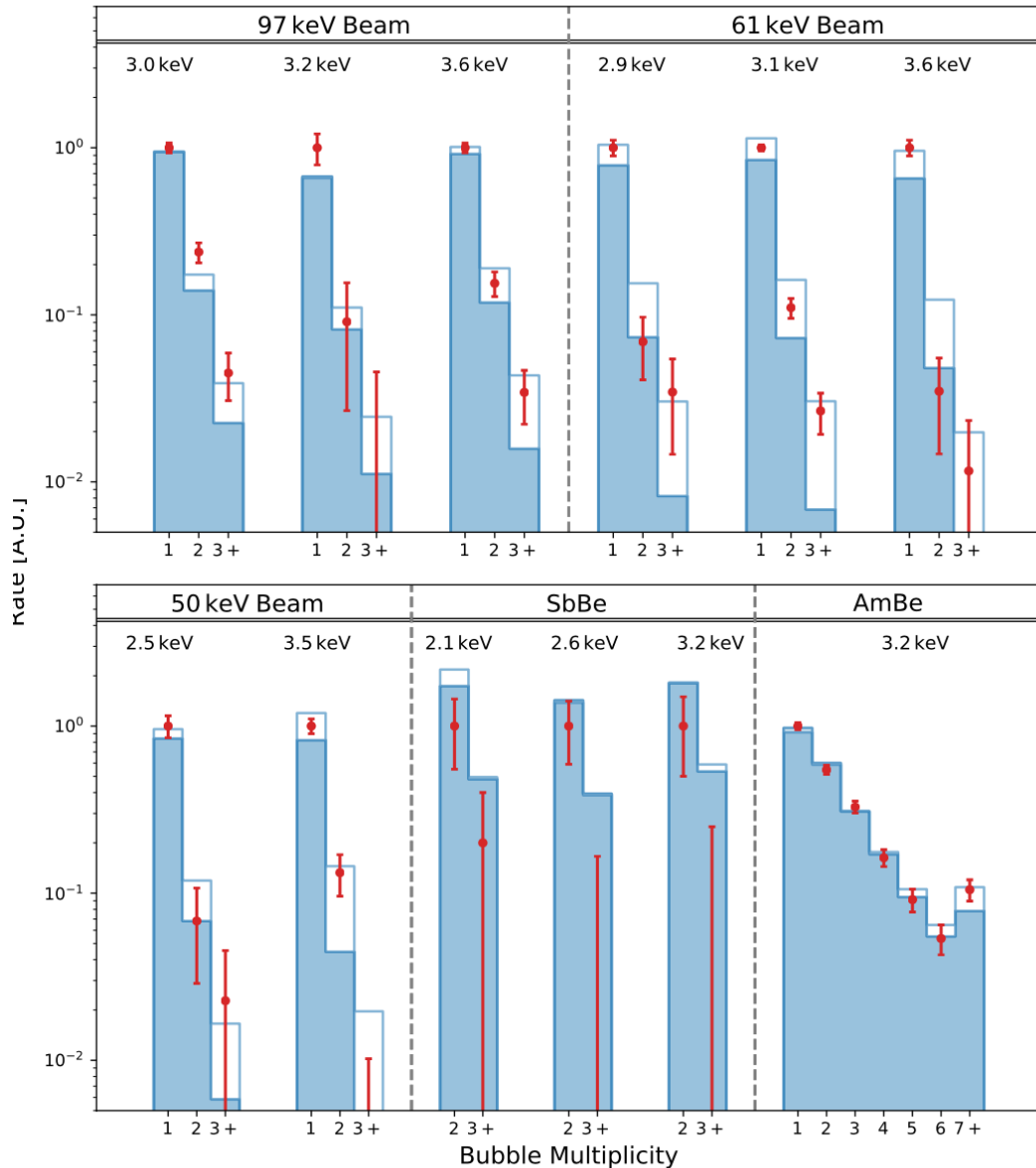

- Multiple neutron calibrations:
  - AmBe at SNOLAB
  - SbBe with small detector
  - Quasi-monoenergetic neutron beam at U of Montreal
- Nuclear recoil (carbon and fluorine) nucleation efficiency model globally fitted with Markov-Chain-Monte-Carlo (MCMC)

# The PICO-60 Detector

- 52.2 kg  $C_3F_8$  target
- Operated at SNOLAB between 2016 -2017
- 1<sup>st</sup> run: 3.3 keV<sub>nr</sub> 1167 kg-day
  - Zero event in ROI  
[Phys. Rev. Lett. 118, 251301 \(2017\)](#)
- 2<sup>nd</sup> run: 2.45 keV<sub>nr</sub> 1404 kg-day
  - [Phys. Rev. D 100, 022001 \(2019\)](#)
- Ultimately background limited from single scatter neutron due to the size of the pressure vessel

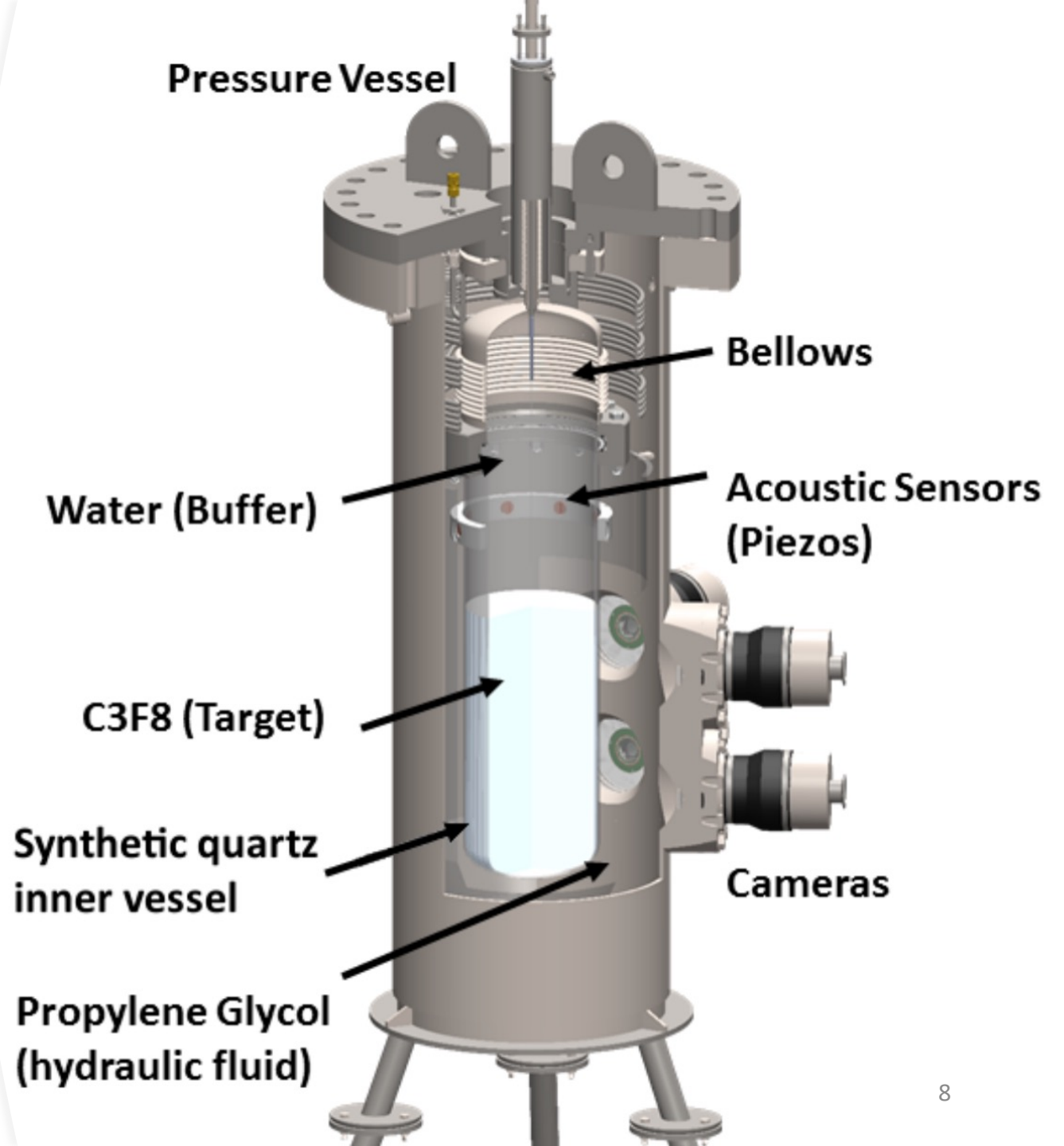



# Results from the complete exposure of PICO-60 at SNOLAB

[Phys. Rev. D 100, 022001 \(2019\)](#)

3.3 keV

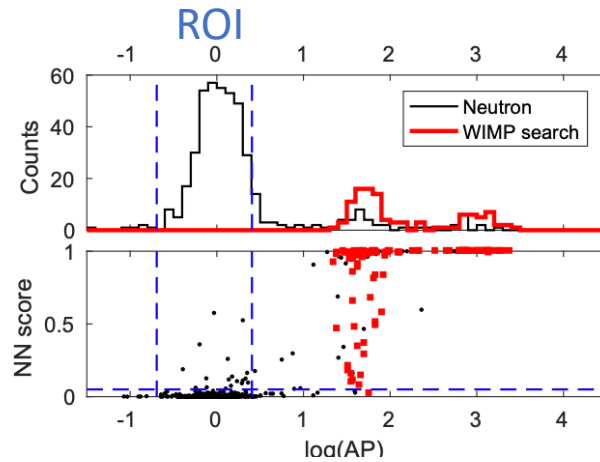
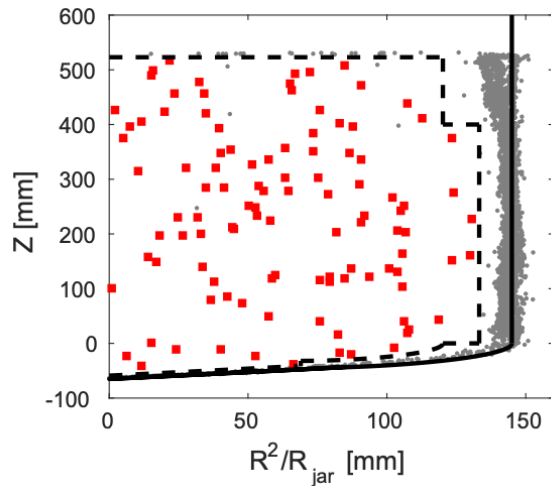

2.4 keV

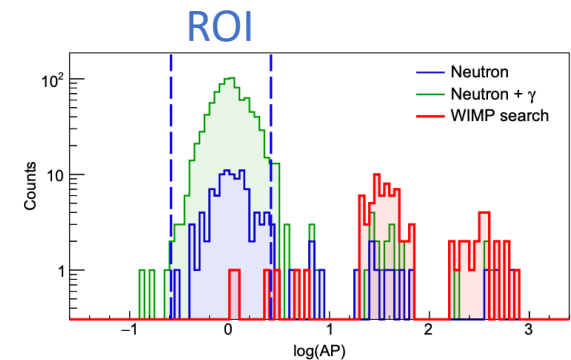
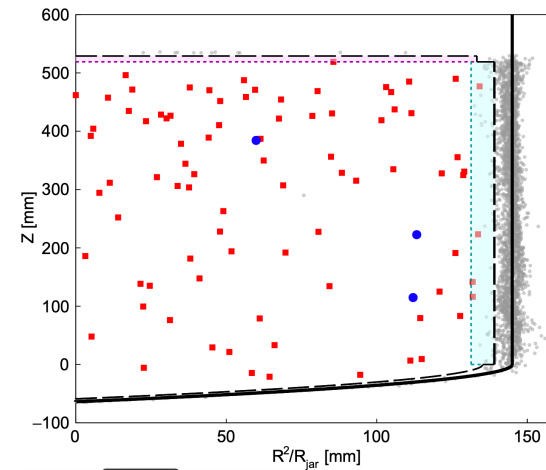

# Results from the complete exposure of PICO-60 at SNOLAB

Phys. Rev. D 100, 022001 (2019)

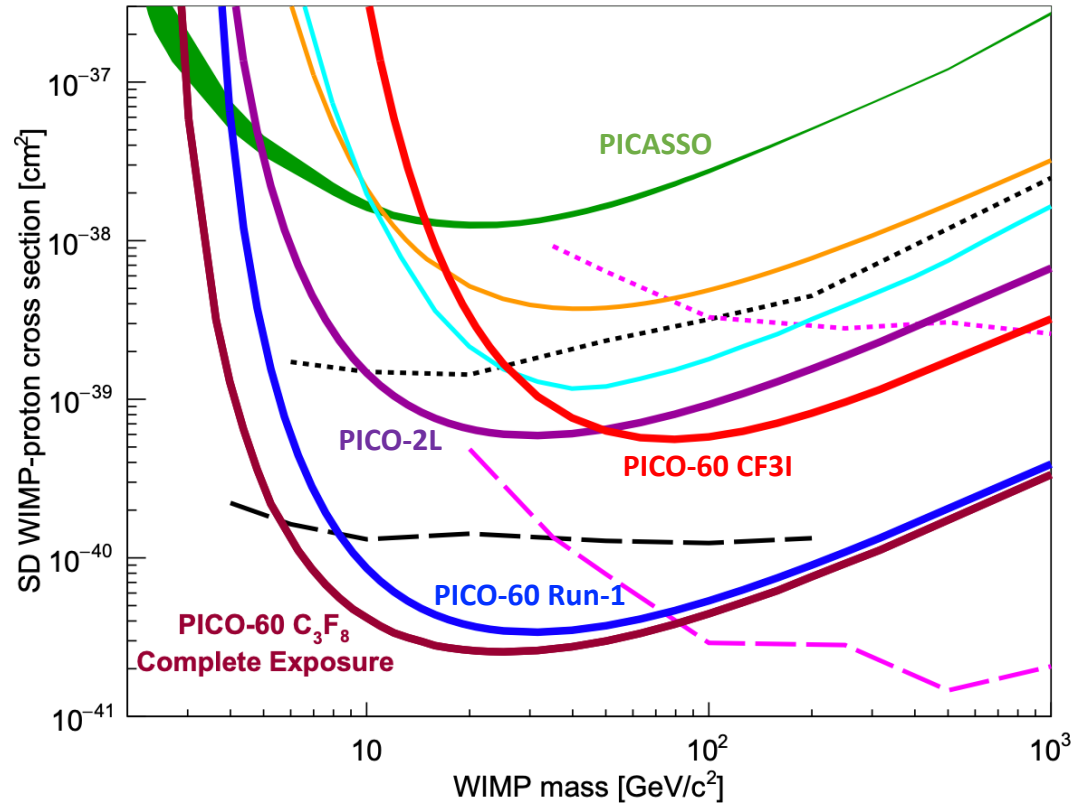

Spin dependent

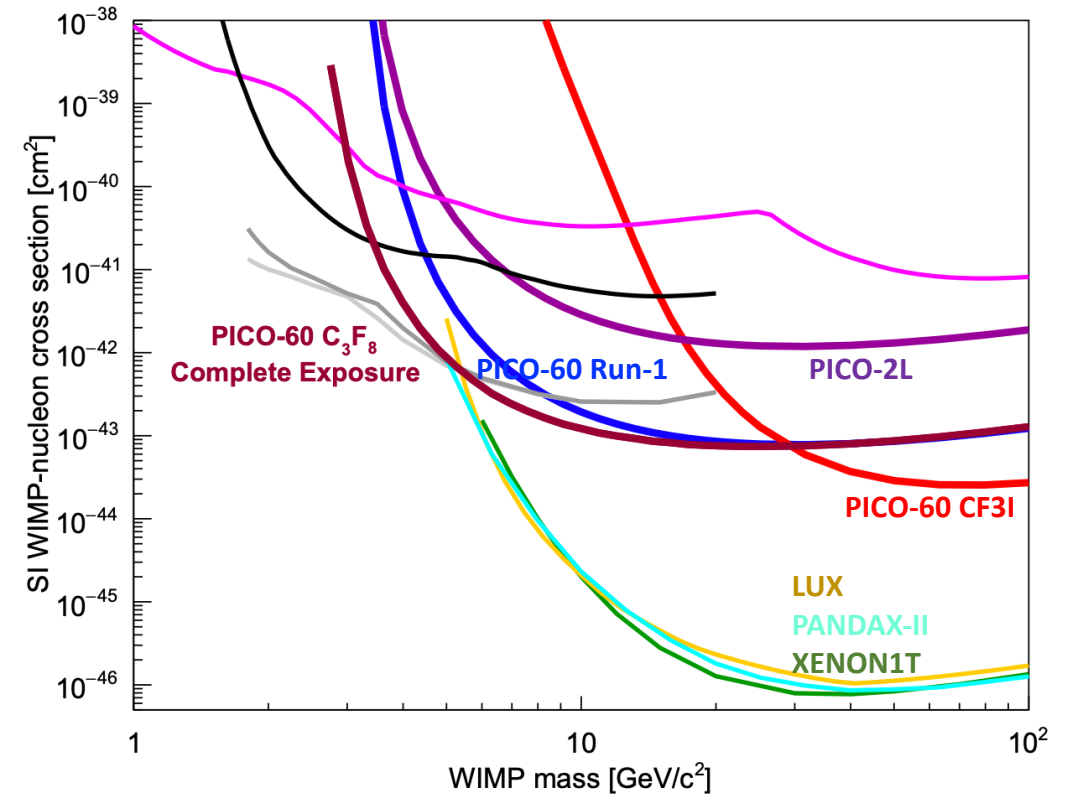

Spin independent

# Continued Physics Exploration with PICO-60

- New results on photon-mediated dark matter-nucleus interactions (anapole, electric and magnetic dipole, millicharged) from the complete exposure of PICO-60: world-leading at low mass ([arXiv:2204.10340](https://arxiv.org/abs/2204.10340)).
- Coming soon: Inelastic dark matter-nucleus interactions from PICO-60  $C_3F_8$  and  $CF_3I$

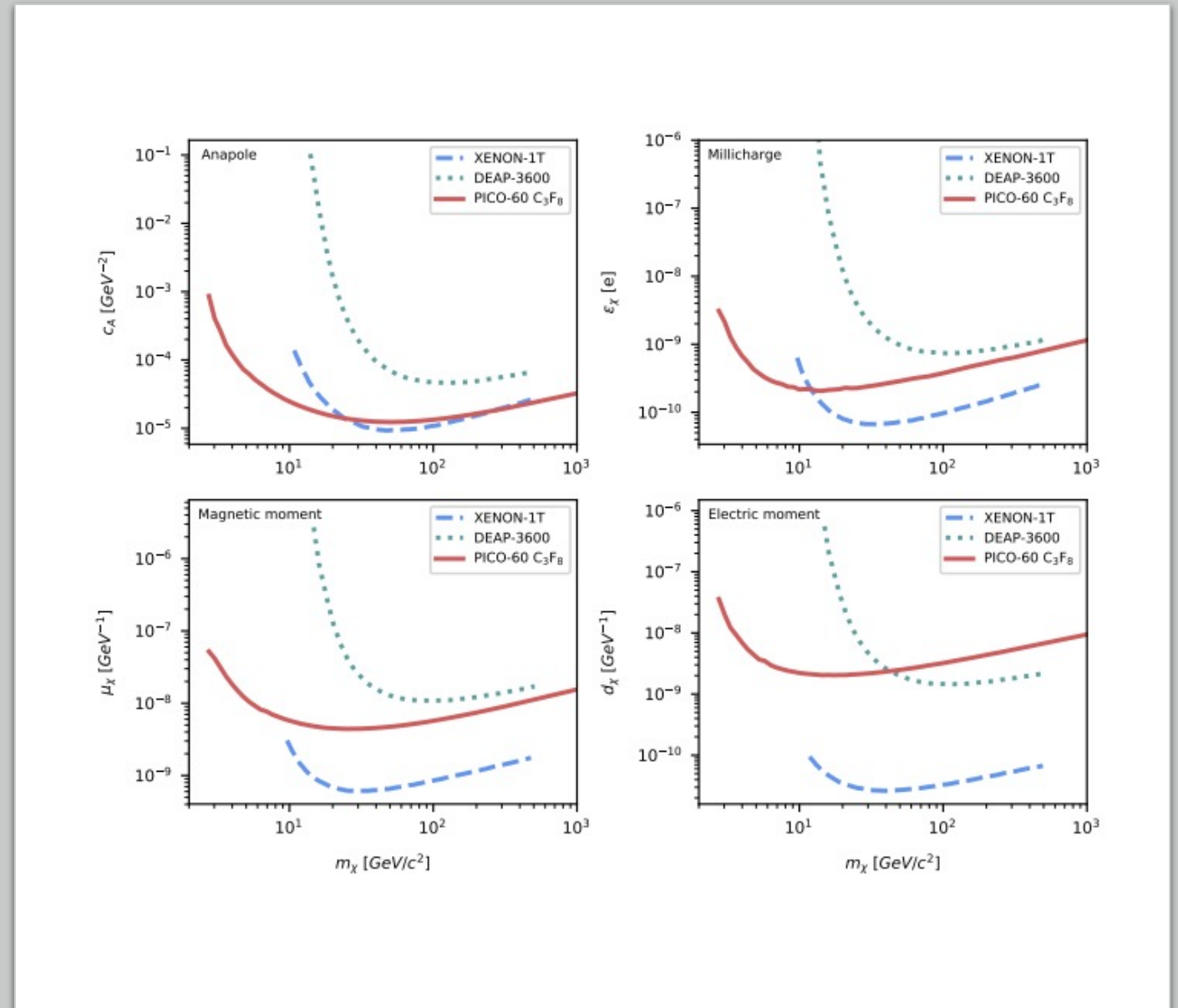

# The PICO-40L Detector at SNOLAB

- PICO-40L is a large-scale prototype of the right-side-up design
- The water buffer is replaced by a thermal gradient that renders the  $C_3F_8$  in the stainless-steel bellows inactive
- Water removal helps with detector deadtime (instability at the water/ $C_3F_8$  interface) and particulates control (anomalous backgrounds seen in PICO-2L and PICO-60  $CF_3I$ )
- Comparable active mass as PICO-60, but new physics reach thanks to larger pressure vessel that contributes to lower neutron background

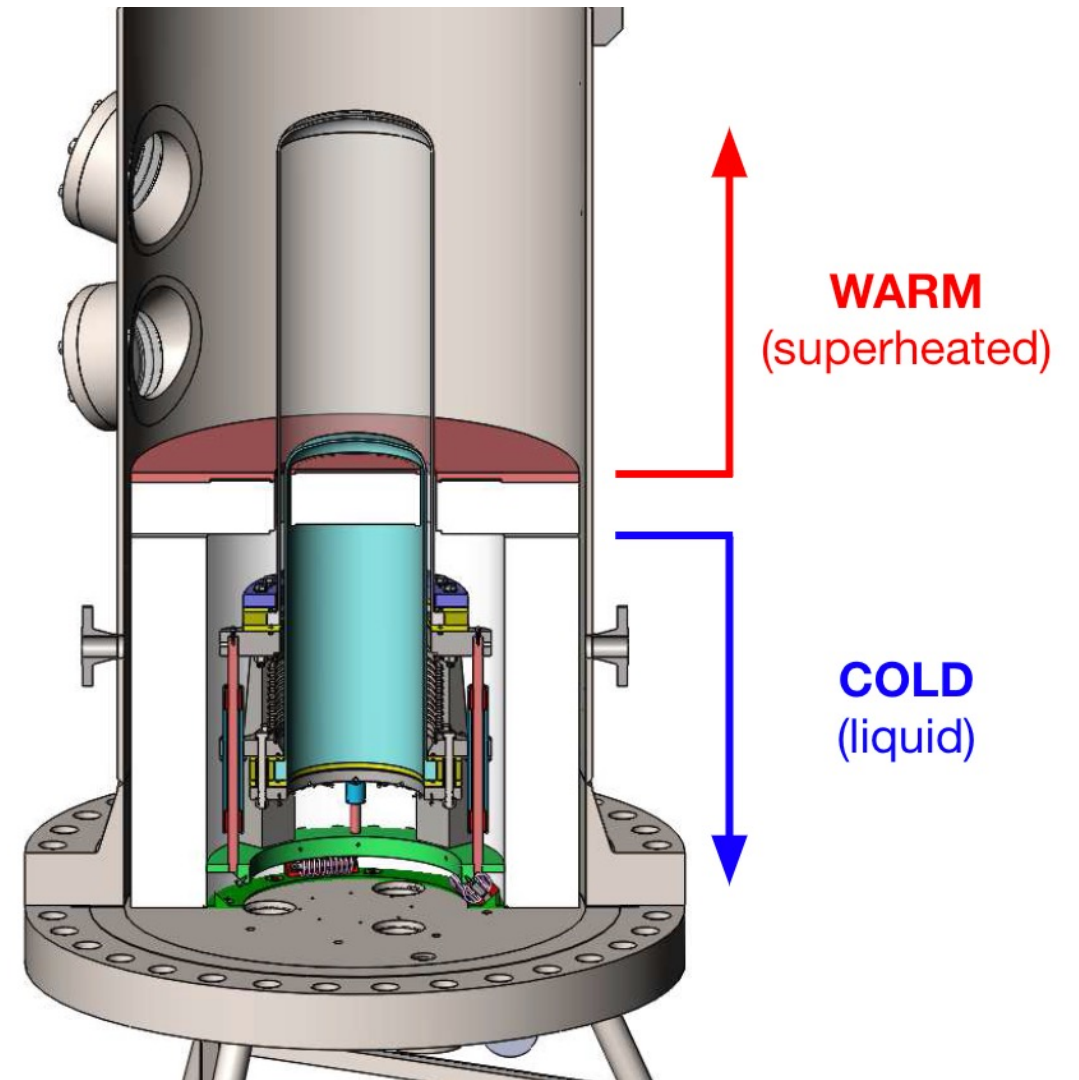

# Status of PICO-40L

- Installation completed in 2019
- Some commissioning data taken, but delayed by chiller issues
- Shortcomings of the thermal design were identified, while a leak in the cooling coils triggered the interruption of operations.
- PICO-40L is being rebuilt with a revised thermal design and a new quartz jar (updated surface treatment method)
- Running expected during summer 2022

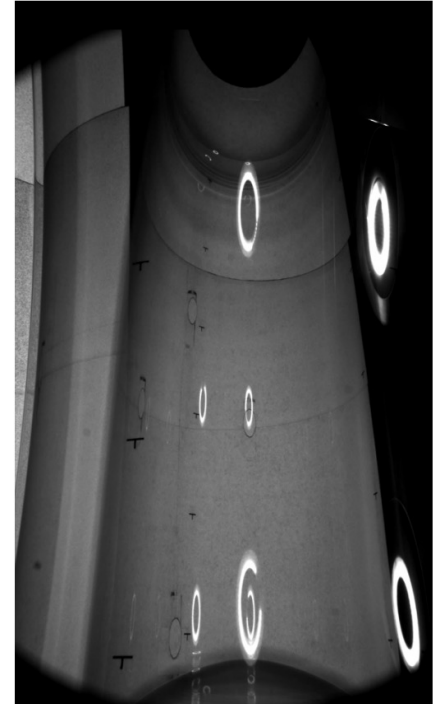
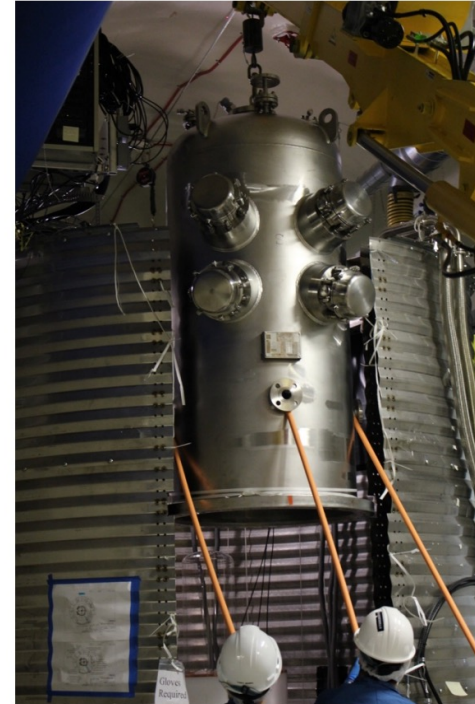

# The PICO-500 Detector at SNOLAB

- Next generation PICO detector to be installed in the miniCLEAN water tank in SNOLAB cube hall
- 260L (420 kg  $C_3F_8$ ) quartz vessel: size limited by fused silica forming methods
- Pressure vessel can hold a 1000 L vessel for future upgrade

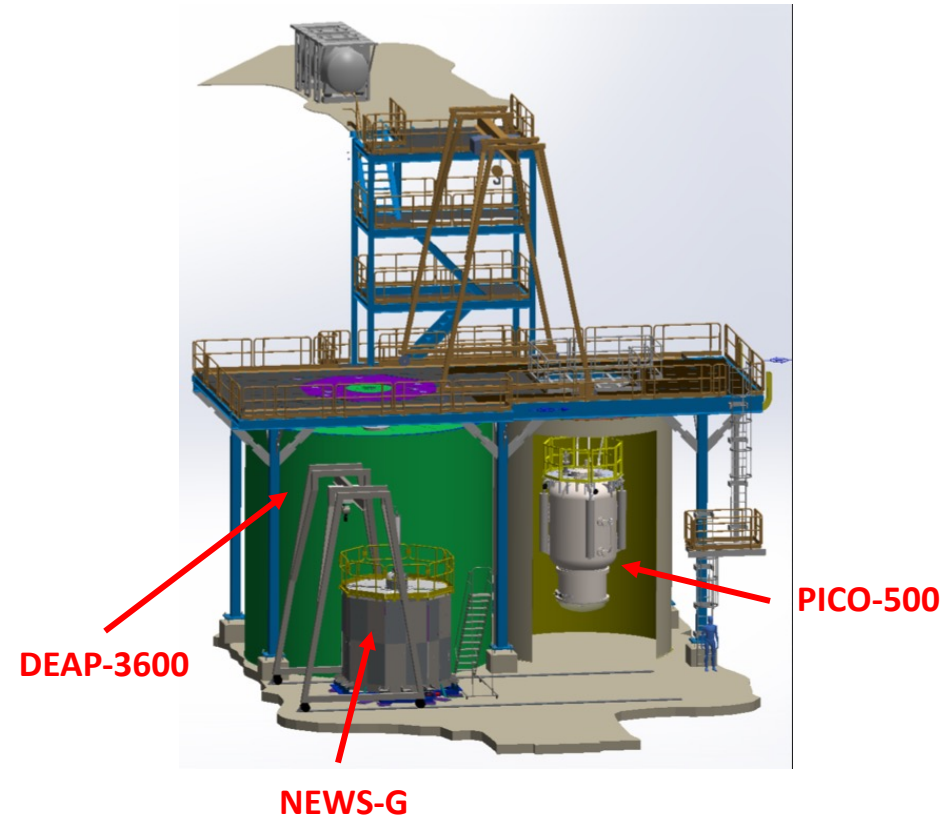
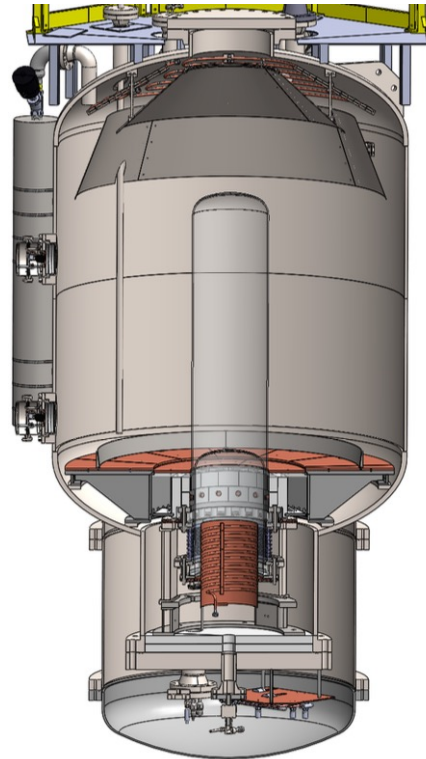
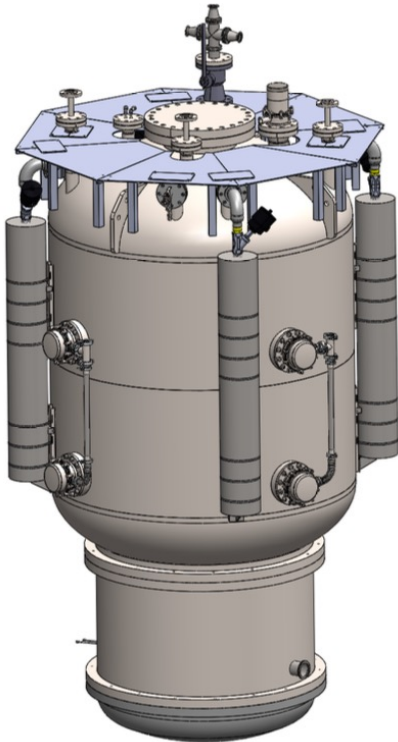

# Outlook

- *Technical Design Review* for PICO-500 is planned for June 2022
- Procurement for quartz jars complete, pressure vessel sent for production
- PICO-500 will have a comparable reach in the  $SD_p$  as LZ in the  $SD_n$  sector
- The neutrino floor for fluorine is far below the neutrino floor for xenon

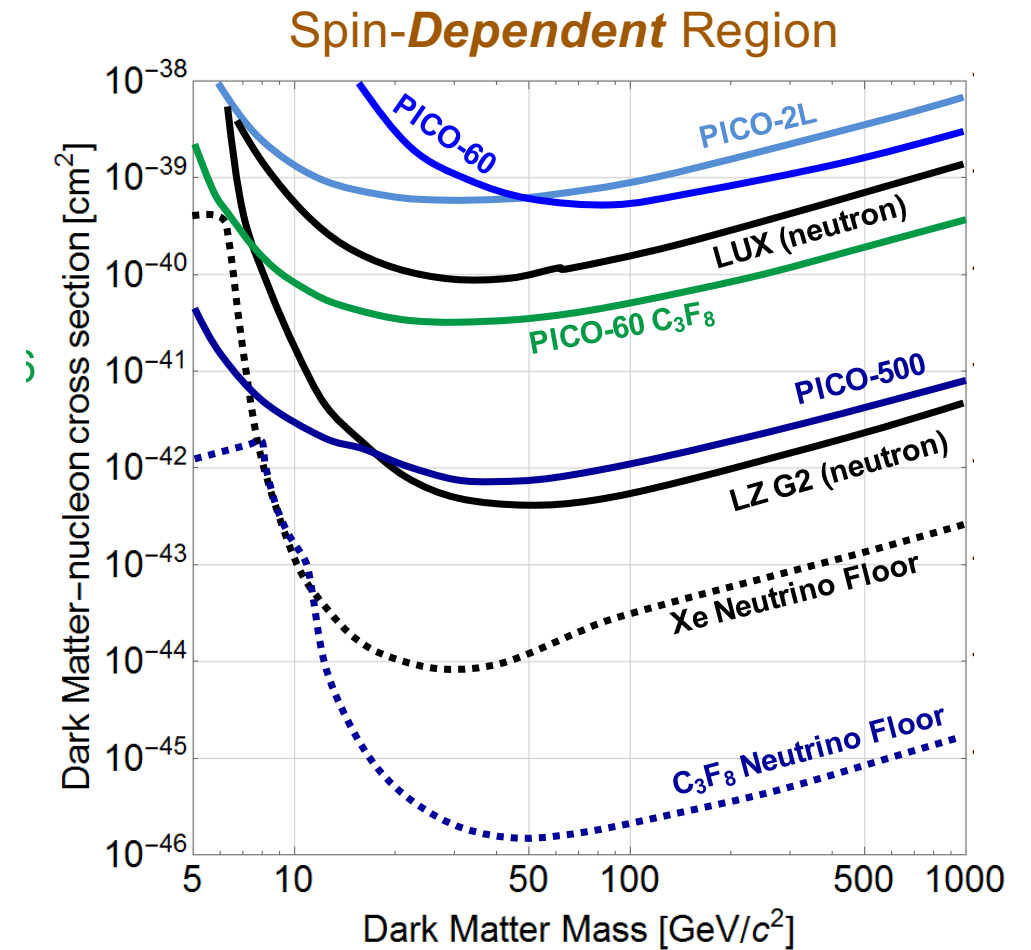

# Thank you!



**PICO**

**SNOLAB**  
I. Lawson

**Northwestern University**  
C.E. Dahl, M. Jin, J. Zhang

**PennState**  
S. Priya, Y. Yan

**České vysoké učení technické v Praze**  
R. Filgas, I. Stekl

**UNIVERSITAT POLITÈCNICA DE VALÈNCIA**  
M. Ardid, M. Bou-Cabo, I. Felis

**Drexel University**  
M. Bressler, R. Neilson

**IF**  
F. Flores, A. Gonzalez, E. Noriega-Benitez, E. Vázquez-Jáuregui

**Fermilab**  
P.S. Cooper, M. Crisler, W.H. Lippincott, A. Sonnenschein

**Northeastern**  
O. Harris

**Queens University**  
B. Broerman, G. Cao, K. Clark, G. Giroux, C. Hardy, H. Herrera, C. Moore, A. Noble, T. Sullivan

**KICP**  
Kavli Institute for Cosmological Physics at The University of Chicago  
D. Baxter, J.I. Collar, J. Fuentes

**UNIVERSITY OF ALBERTA**  
C. Coutu, N.A. Cruz-Venegas, S. Fallows, T. Kozynets, C. Krauss, S. Pal, M.-C. Piro, W. Woodley

**INDIANA UNIVERSITY SOUTH BEND**  
K. Allen, E. Behnke, I. Levine, N. Walkowski, A. Weesner

**Université de Montréal**  
S. Chen, M. Laurin, J.-P. Martin, A.E. Robinson, N. Starinski, D. Tiwari, V. Zacek, C. Wen Chao,

**Pacific Northwest NATIONAL LABORATORY**  
I. Arquist, T. Grimes, B. Hackett, A. Hagen, C.M. Jackson, K. Kadooka, B. Loer

**Laurentian University Université Laurentienne**  
J. Farine, A. Le Blanc, T. Hillier, C. Licciardi, O. Scallon, U. Wichoski

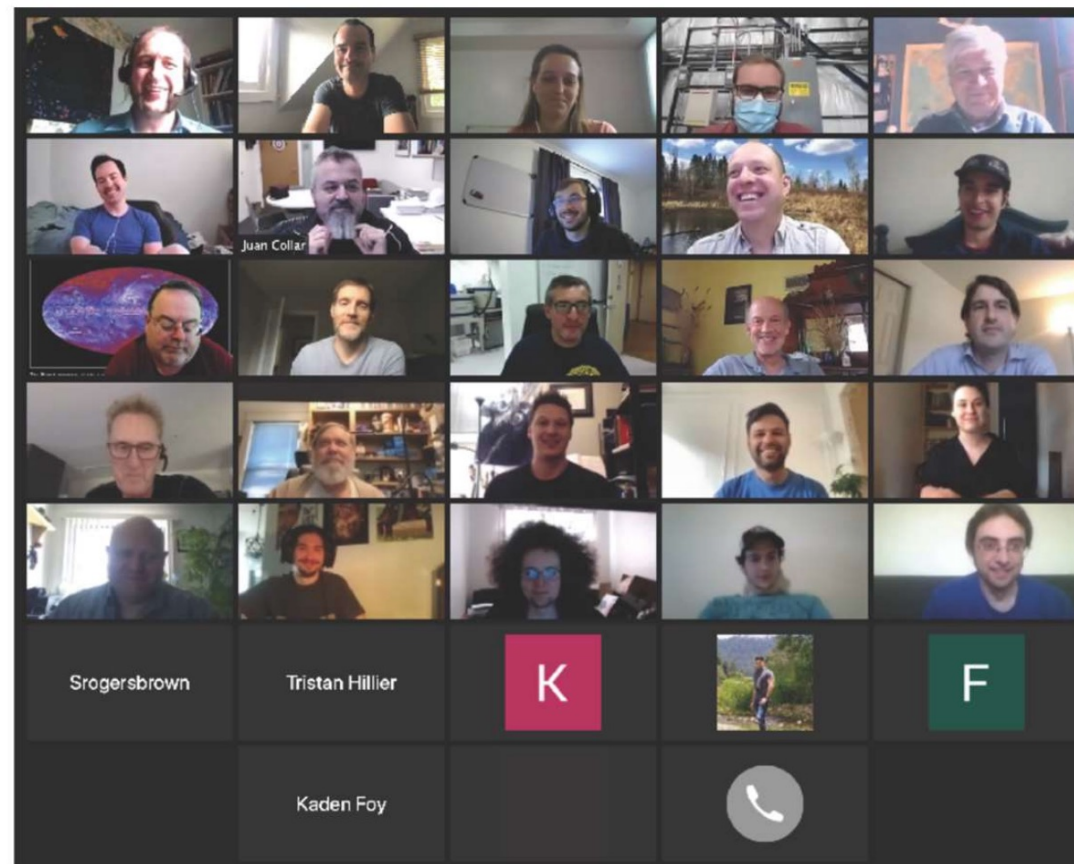



# Extra Slides

---

# Theoretical Motivations [arXiv:2104.03245](https://arxiv.org/abs/2104.03245)

New theoretical work on pMSSM models that are not excluded by LHC, provide a dark matter candidate and an explanation for the  $g-2$  anomaly, and are minimally fine-tuned.

Direct detection searches are complementary in regions of the MSSM parameter space where the LHC has little sensitivity

Current and future PICO experiments at SNOLAB will be able to test all these models in the Spin-Dependent sector

