

# Light Detection

Summer Particle AstroPhysics Workshop 2022

*PMTs, SiPMs,...*

*Peter Skensved  
Queen's University*

# Photo Electric Effect

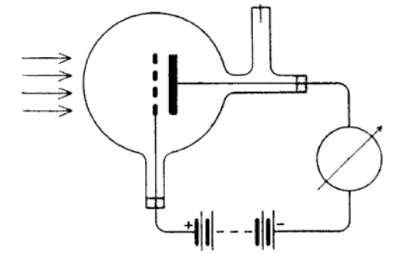

P Lenard, 1902

- Certain materials emit electrons when exposed to light
- Effect discovered ( rediscovered ) many times during the 19<sup>th</sup> century
- Four basic observations
  - If we see electrons the number emitted scales with the intensity of the incident light
  - Energy of electron does not depend on intensity of light
  - Above a certain wavelength no electrons are emitted regardless of the intensity of the incident light
  - The electron energy increases with decreasing wavelength of the incident light
- Explained by Einstein in 1905 ( *Nobel Prize in 1921* )
- 

*Last 3 observations make little sense from a classical physics perspective !*

## Einstein to the rescue ...

- The photon energy is quantized and is proportional to  $\nu$ . Energy conservation implies that the electron kinetic energy is then given by :

$$E = h \nu - W \quad (W \text{ is work function of material})$$

- The constant  $h$  is the same as the one introduced by Max Planck in 1901 to explain “black-body” radiation

-----

Note that classically an electromagnetic ( plane ) wave can have *any* energy – the energy is related to the surface integral of Poynting's vector which is proportional to  $|\mathbf{E}_0|^2$ . Quantization is totally foreign to classical physics.

-----

So - given photosensitive material and sufficient “amplifier” gain we can use the photoelectric effect to detect single ( or a small number of ) photons :

At  $\sim 10^7$  gain : 1 photon  $\Rightarrow$  1.6 pC which is relatively easy to measure with standard electronics .

Since  $c = \nu \lambda$  we can also write  $E_\nu = h \nu = h c / \lambda = \hbar \omega$

## A bit of Solid State Physics ...

- Simplest model of a material is the Free Electron Fermi Gas Model
- Treat electrons as non-interacting, classical objects
- Electron energy is just kinetic the energy :

$$\varepsilon = \frac{\hbar^2 \mathbf{k}^2}{2 m_e}$$

- At  $T = 0$  fill states up to Fermi energy  $\varepsilon_F$  ( or Fermi wavevector  $\mathbf{k}_F$  )
- $\varepsilon_F$  depends on particle density only
- Remarkably successful model despite the crude assumptions....
- Properties of a material at finite  $T$  depends on density of states  $g(\varepsilon)$  and probability that level at  $\varepsilon$  is occupied ( Fermi-Dirac statistics ) :

$$f_{FD}(\varepsilon) = \frac{1}{1 + \exp\left(\frac{\varepsilon - \varepsilon_F}{kT}\right)}$$

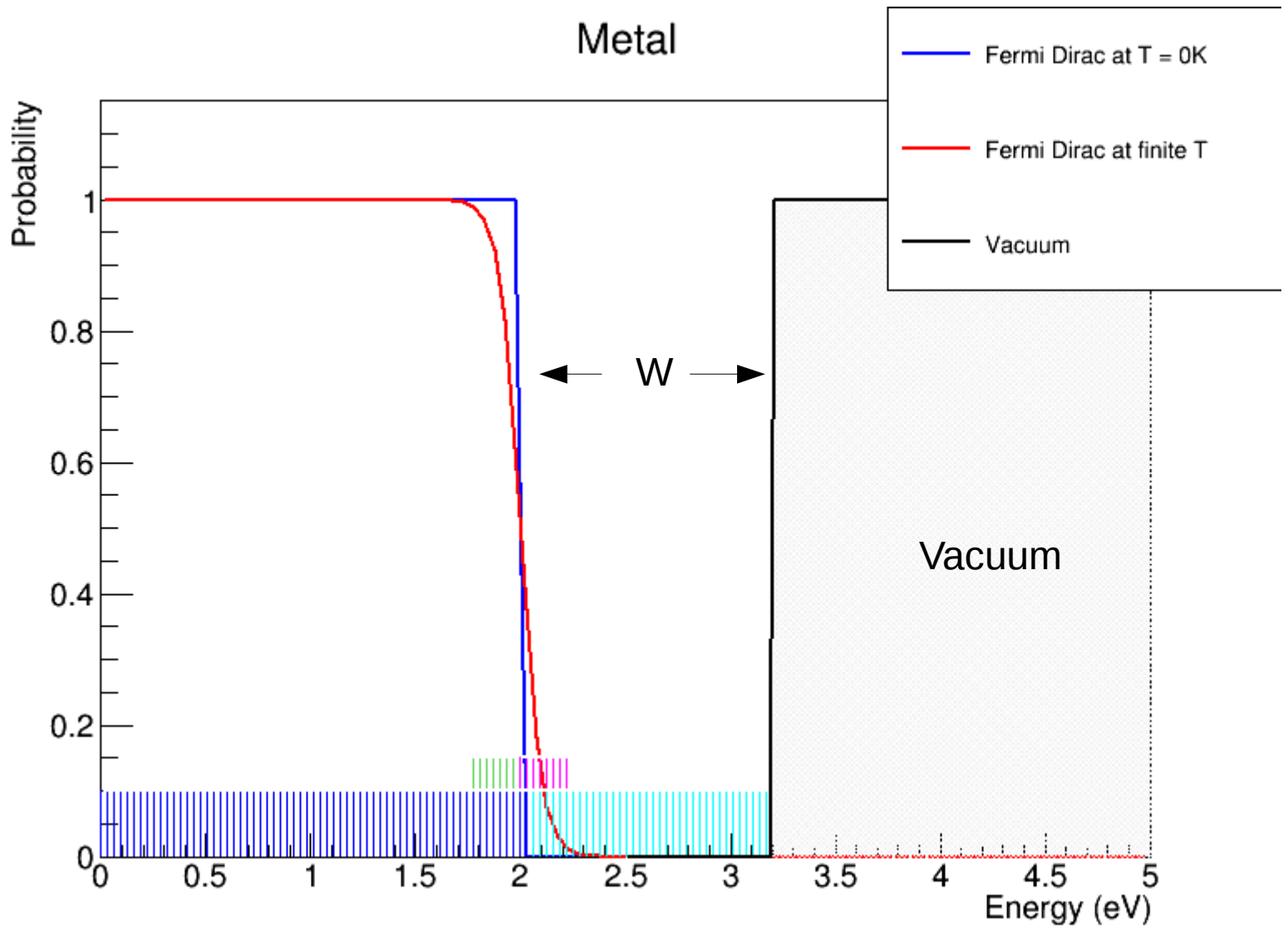

# Semiconductors

In real life the levels are not equally spaced, there are gaps due to atomic effects. For a semiconductor the Fermi energy happens to sit in a gap. That is – there is an order of a few electron volt gap separating the valence and conduction bands. The electron kinetic energy is given by :

$$E = h \nu - E_G - E_A$$

Affinity and gap energy is used instead of workfunction

As for metals, the Fermi-Dirac function tells us the probability that a given level is occupied . At finite T the “tail” of the F-D function overlaps the conduction band leading to free electron – hole pairs and thus finite conductivity  
( *higher temperature required and lower number of pairs compared to metal* )

# Semiconductor

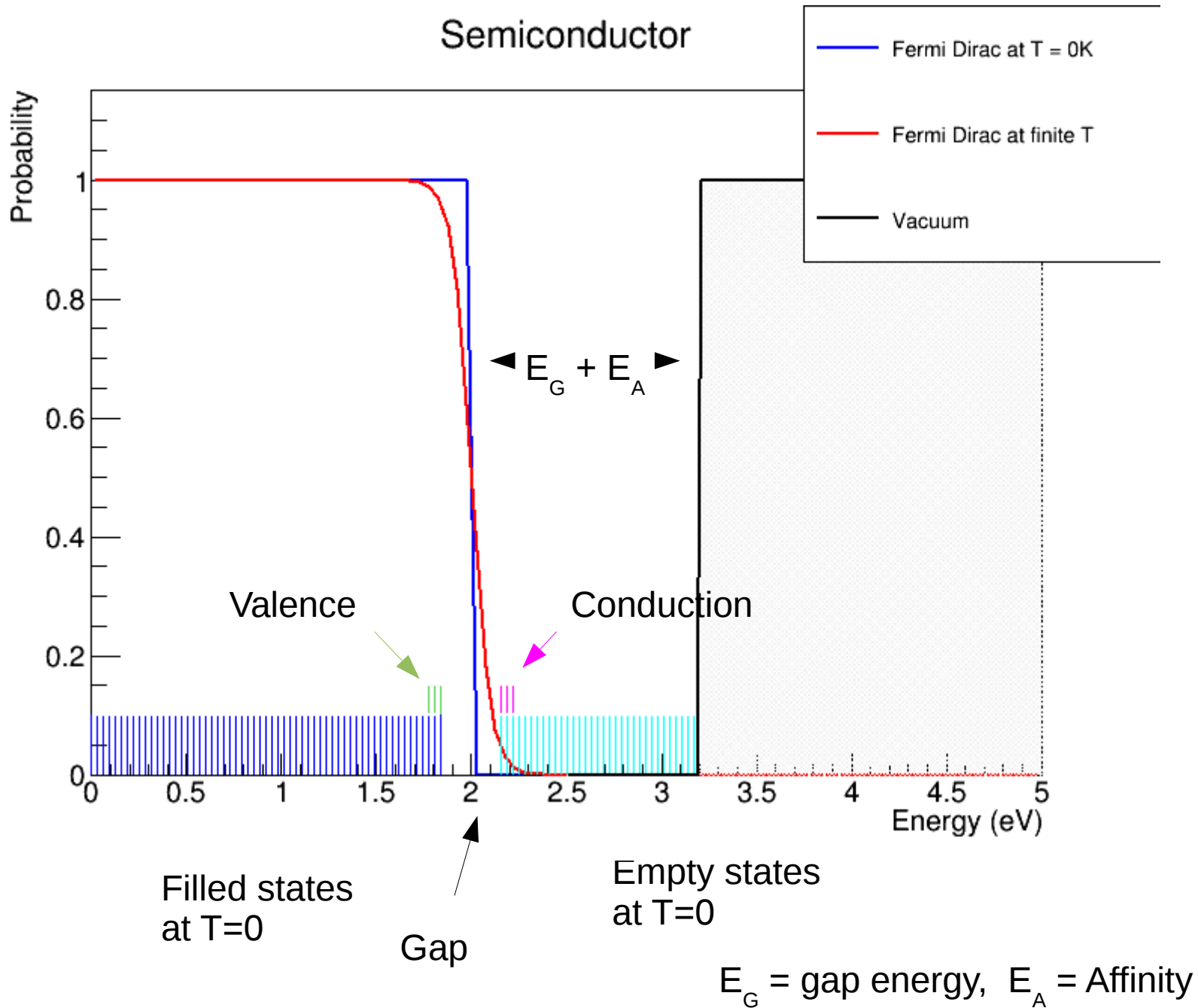

# Semiconductors cont'd.

What happens when a photon strikes a semiconductor depends on the wavelength of the photon and where the band gap in the semiconductor is located :

Low energy photons can create an  $e^-$  - hole pair with finite lifetime ( photovoltaic effect ) .

If we introduce a p-n junction and apply a voltage things are much more interesting. We can make "detectors"

Of special interest are materials where the band gap is in the visible or near UV

Some example materials :

Photon energies, wavelengths and semiconductor band

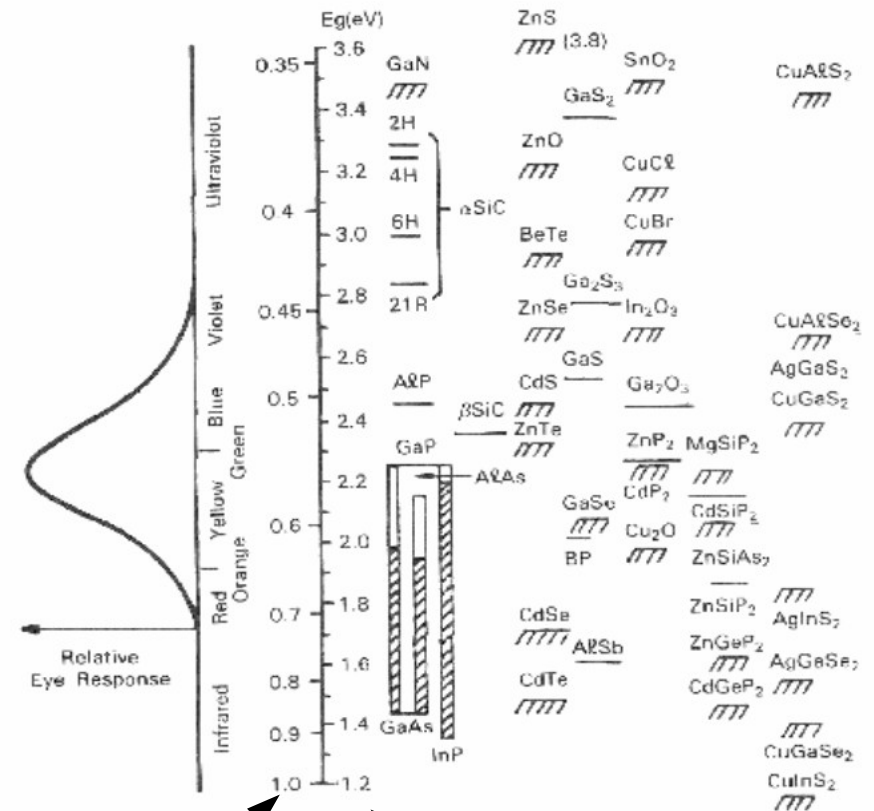

Wavelength in microns

Energy in eV



# Semiconductors ( cont'd. )

There are several different modes for semiconductor devices :

- Photovoltaic – *no bias, voltage builds up ( solar panel )*
- Photoconductive – *reverse bias creates depletion region (photo diode)*
- Avalanche – *very high reverse bias resulting in an avalanche*
  - (Near) breakdown mode in the extreme

We're mostly interested in single photon detection and usually require fast timing (  $< 10\text{ ns}$  ) so only the avalanche mode is really of interest here.

A CdS photocell is an example of a photoconductive device

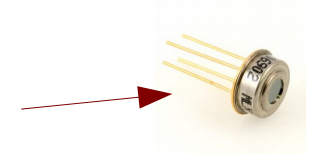

Reverse bias means cathode driven positive wrt. anode

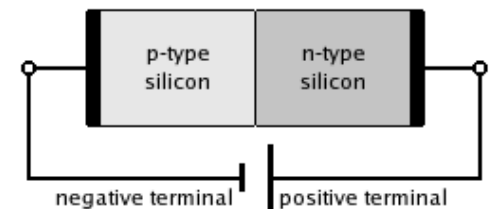

## Rest of slides ...

- We now have the background necessary to understand real light detecting devices
- Look at “classical” ( PMTs ) first
- Then transition through hybrid designs
- End up with solid state devices
-

# Photomultipliers : How do they work ?

- Photon strikes ( thin ) photocathode & creates free photo electron ( PE )
- PE is accelerated by voltage between cathode and first dynode
  - Electron(s) hitting dynode creates several secondaries (  $g \sim 3-7$  )
  - Secondaries are accelerated to next dynode
- Repeat for  $n$  stages . Total Gain  $\sim g^n$

gain in excess of  $10^7$  achievable

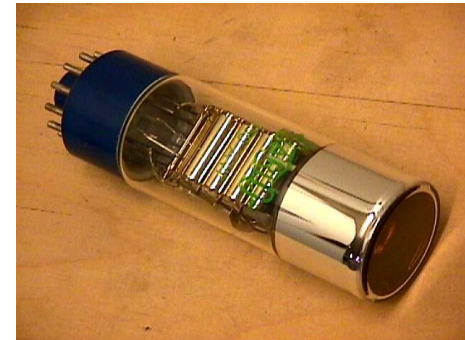

MiniBoone PMT

from [http://weather.nmsu.edu/Teaching\\_Material/SOIL698/Student\\_Reports/Spectroscopy/detector.htm](http://weather.nmsu.edu/Teaching_Material/SOIL698/Student_Reports/Spectroscopy/detector.htm)

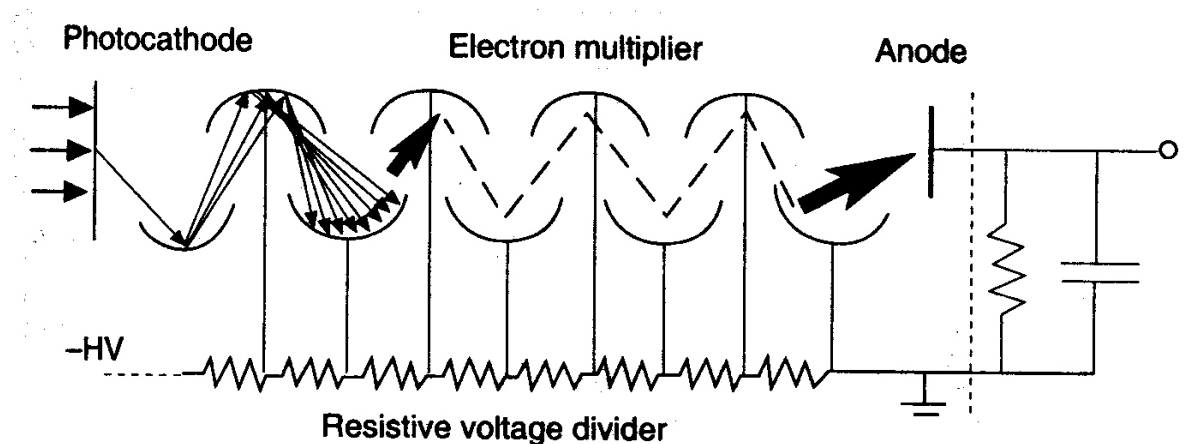

Fig. 3.22 The construction of a photomultiplier.

from Sayer

# PMT Parameters/Terms/Quantities...

- Quantum efficiency – *PE per incident photon ( usually in % )*
- Collection efficiency – *probability of PE hitting first dynode*
- Gain – *Electrons out per PE in*
- Dark current - *Rate due to “noise”*
- Timing – *RMS of arrival times ( also referred to as Transit Time Spread )*
- Charge resolution – *Ability to separate 0, 1, 2, ... PE distributions*
- After pulsing, Late pulsing, Pre pulsing – *see below*
- Magnetic field sensitivity -
- Dynamic range -
- Saturation -
- Linearity -
- Cathode uniformity -
- 





Hamamatsu R5912

EMI 920 2"

Hamamatsu R1408

R5912 Dynodes ( box )

Venetian blind

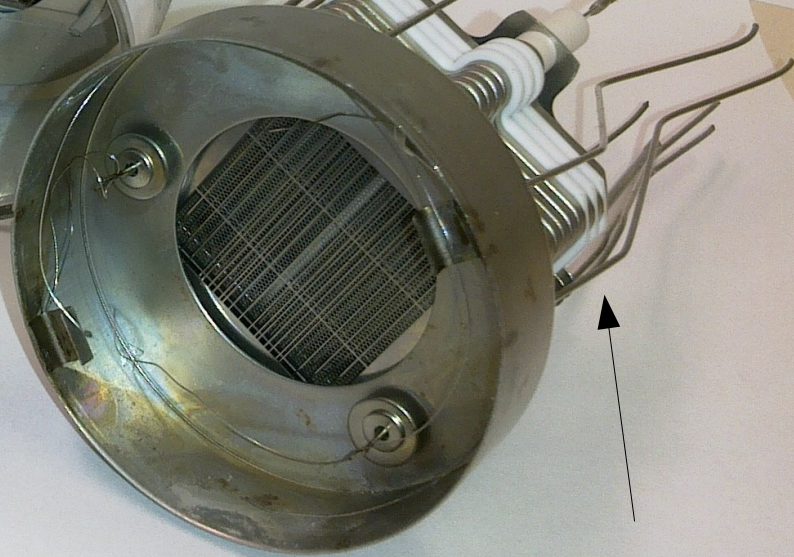
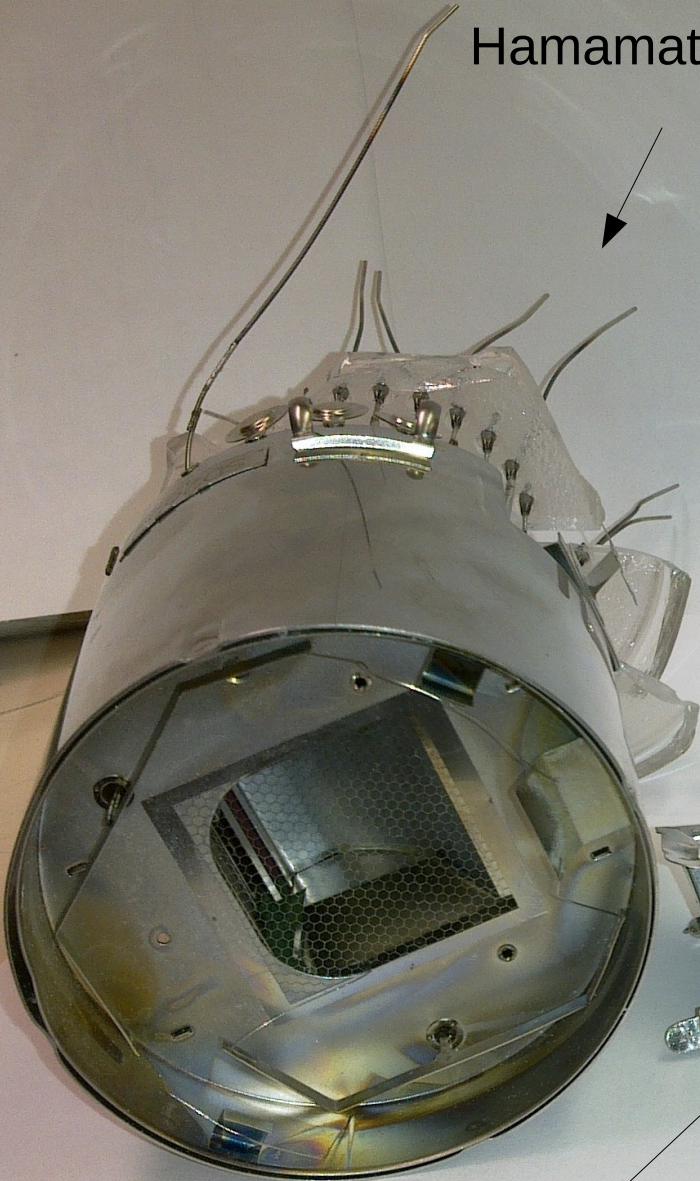



## Photocathodes ...

- Making photocathodes is black magic ..
- For the most part mixtures of Na, K, Cs, Sb, ...
- Use special crystalline form to get higher QE (*Hamamatsu sorcery ..*)
- Usually unstable so must be evaporated onto glass after PMT is evacuated
- Very thin layer for transmission type cathodes (*~ 25 nm*)
- Thickness is a compromise between photon absorption and PE emission
- Has high ( complex ) index of reflection (*real part ~ 3.5*)
- Large reflection at photocathode / vacuum interface

Photocathode materials become insulators at low temperature.  
Cryogenic PMTs need extra conductive layer to avoid buildup of charge

( *MiniClean PMTs have Pt underlay* )

# Quantum Efficiency

QE of a PMT is measured by shorting all dynodes, applying a small voltage and exposing the tube ( full surface ) to a lamp. The QE is then basically current out over current in.

Relative QE is usually quite accurate, absolute not so much ...

Note that QE includes geometry, reflections, glass in addition to the actual magic ingredients in the photocathode.

May also include components from other ( non-sensitive ) parts of the stack

Cathode Radiant Sensitivity Block Diagram

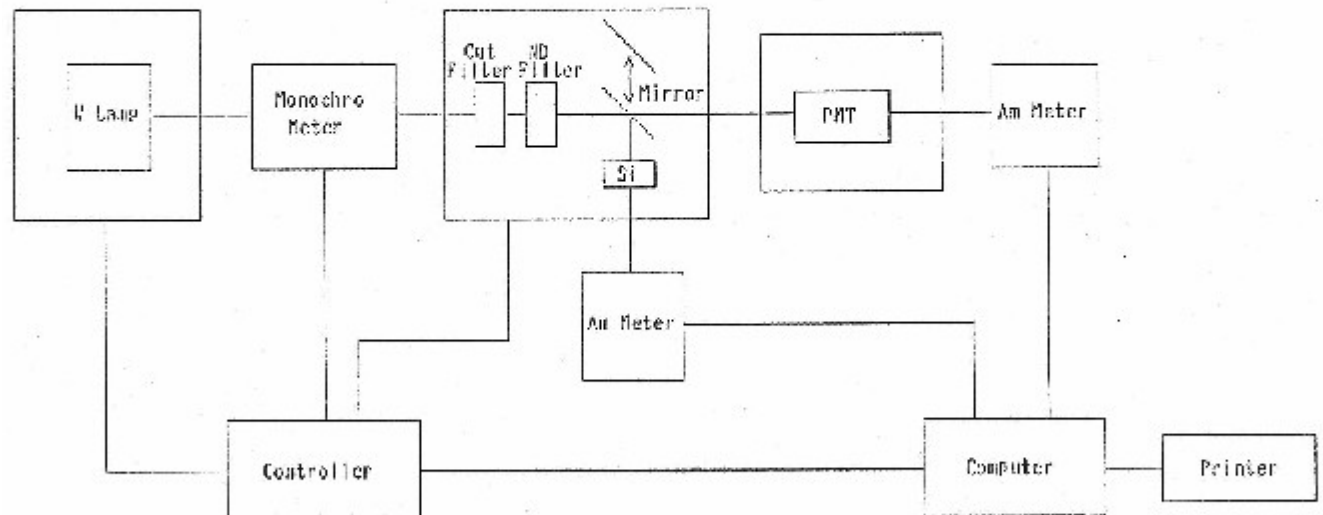

*Note that you cannot use published QE directly in a Monte Carlo without removing other factors !*

# R5912HQE DEAP Timing

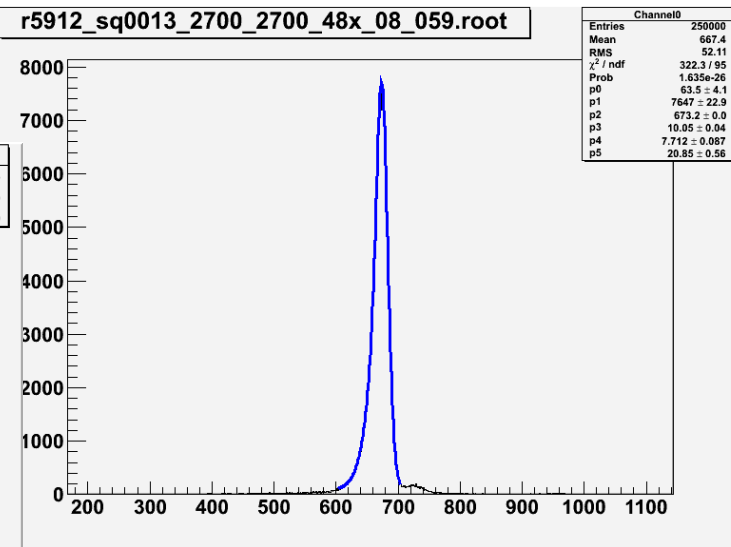
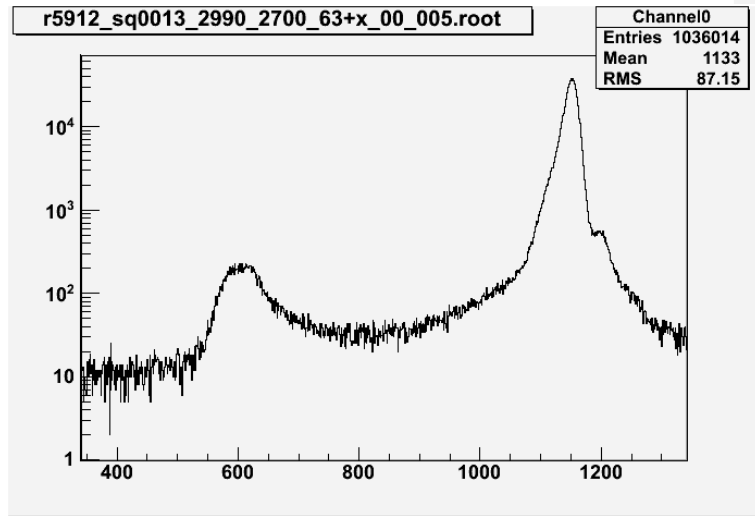

Prepulsing : Electron skips first dynode

Late pulsing : Electrons scattered off first dynode back into vacuum

~10 channels / ns

# R1408 SNO Timing

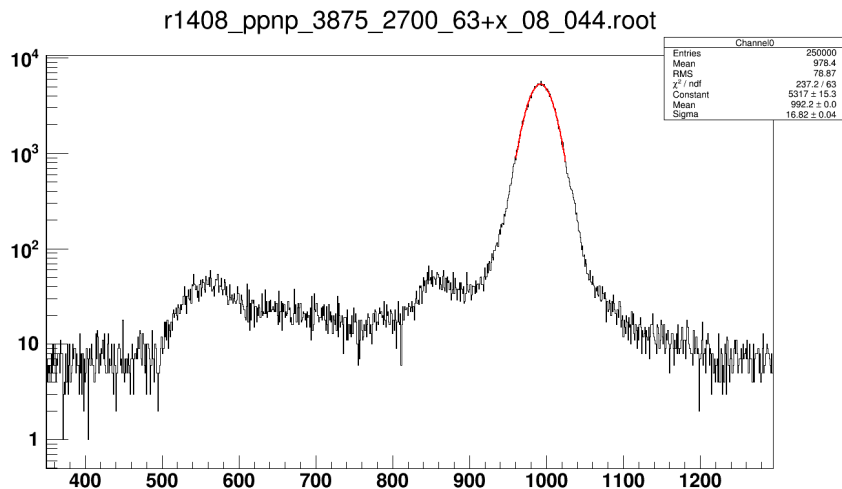

Good P/V

Dynode noise

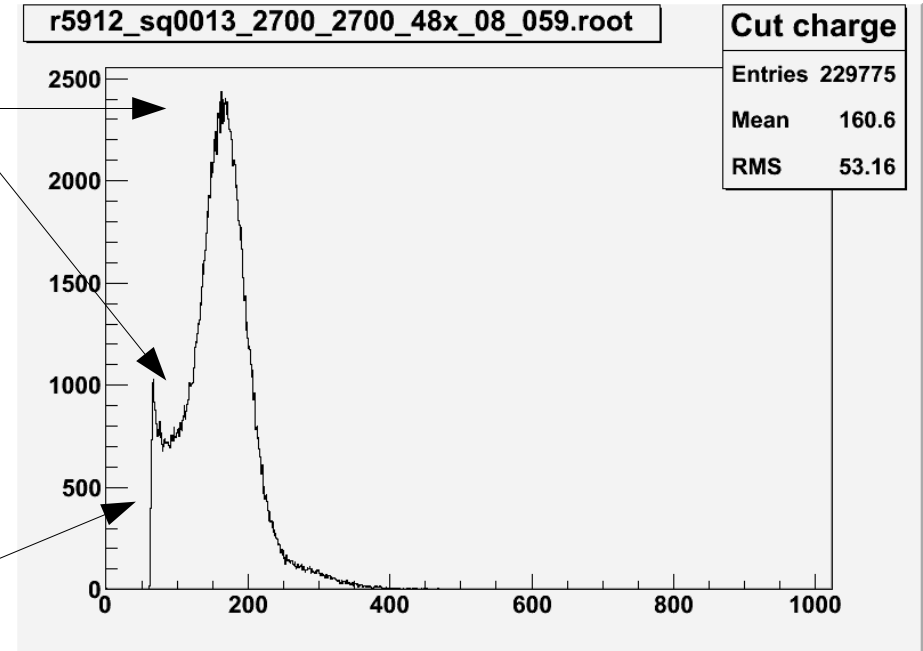

Single PE spectrum ( gated on prompt time from  $\check{C}$  source )

Note different late pulsing features !



# Afterpulsing

- Photoelectron hits ( neutral ) atom and ionizes it . Ion is accelerated to photocathode and knocks off one or more electrons.
- These electrons look exactly like photoelectrons
- Drift times are long (  $0.5$  to  $10 \mu\text{s}$  )
- The observed AP charge depends on the mass of the ion
- Timing scales with square root of C – D1 voltage and square root of ion mass.

- *R5912HQE Afterpulsing Distribution ( 10 ns / ch )*

PMTs should not be exposed to helium as it diffuses through everything ...

*Helium would be at extreme left ( no sign of it in this PMT ... )*

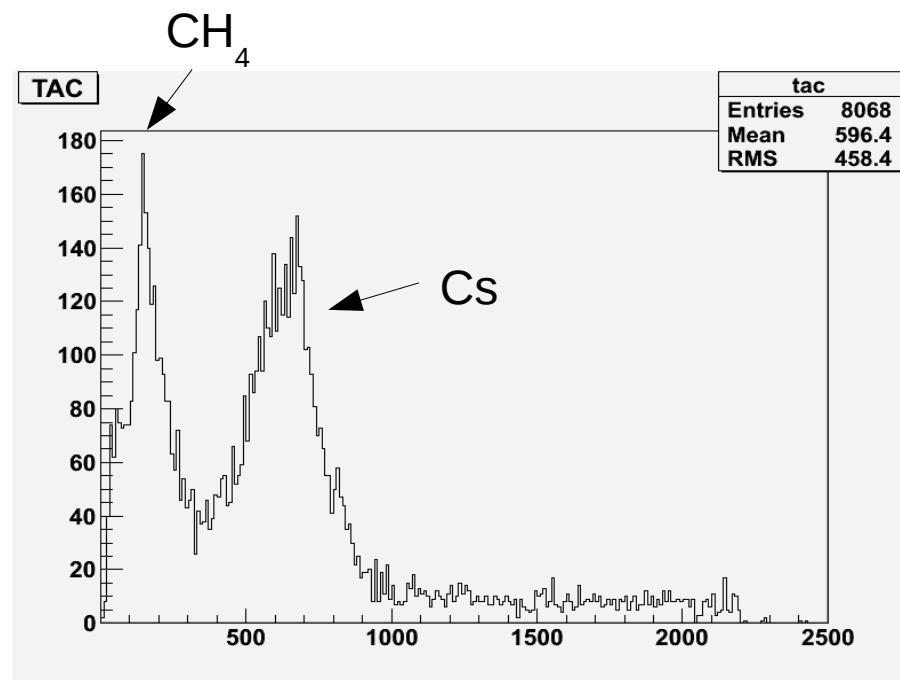

## Summary ( PMTs )

- ✓ Can detect single photons
- ✓ Built-in amplifier with gain of 100,000 to 10,000,000
- ✓ Reasonably linear at low light levels if designed correctly
- ✓ Efficiency of up to 30% ( *claims of higher but beware ...* )
- ✓ Can have 3 orders of magnitude dynamic range
- ✓ 1 – 2 ns timing if designed correctly
- ✓ Simple ( passive ) design
- 
- ✗ Requires HV
- ✗ May saturate at high rates or for large pulses ( *space charge affects field between last dynodes – leads to pulse distortion* )

# Improvements to PMTs

Charge resolution is pretty bad for a standard PMT. We cannot do anything about Poisson statistics but we might be able to “fix” D1 contribution if we can increase the gain :

⇒ GaP(Cs) coated D1

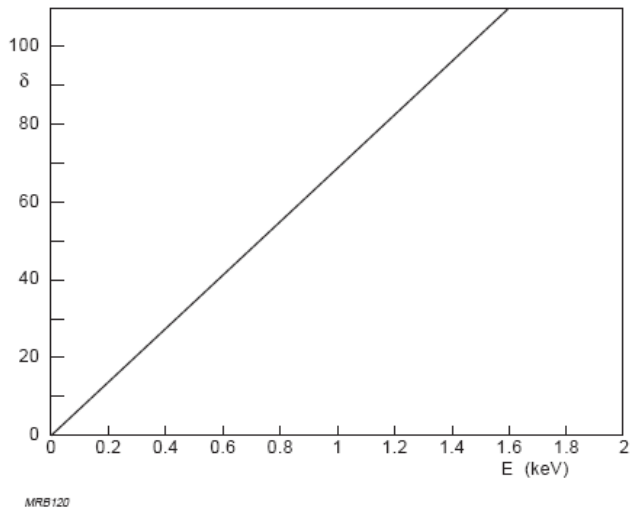
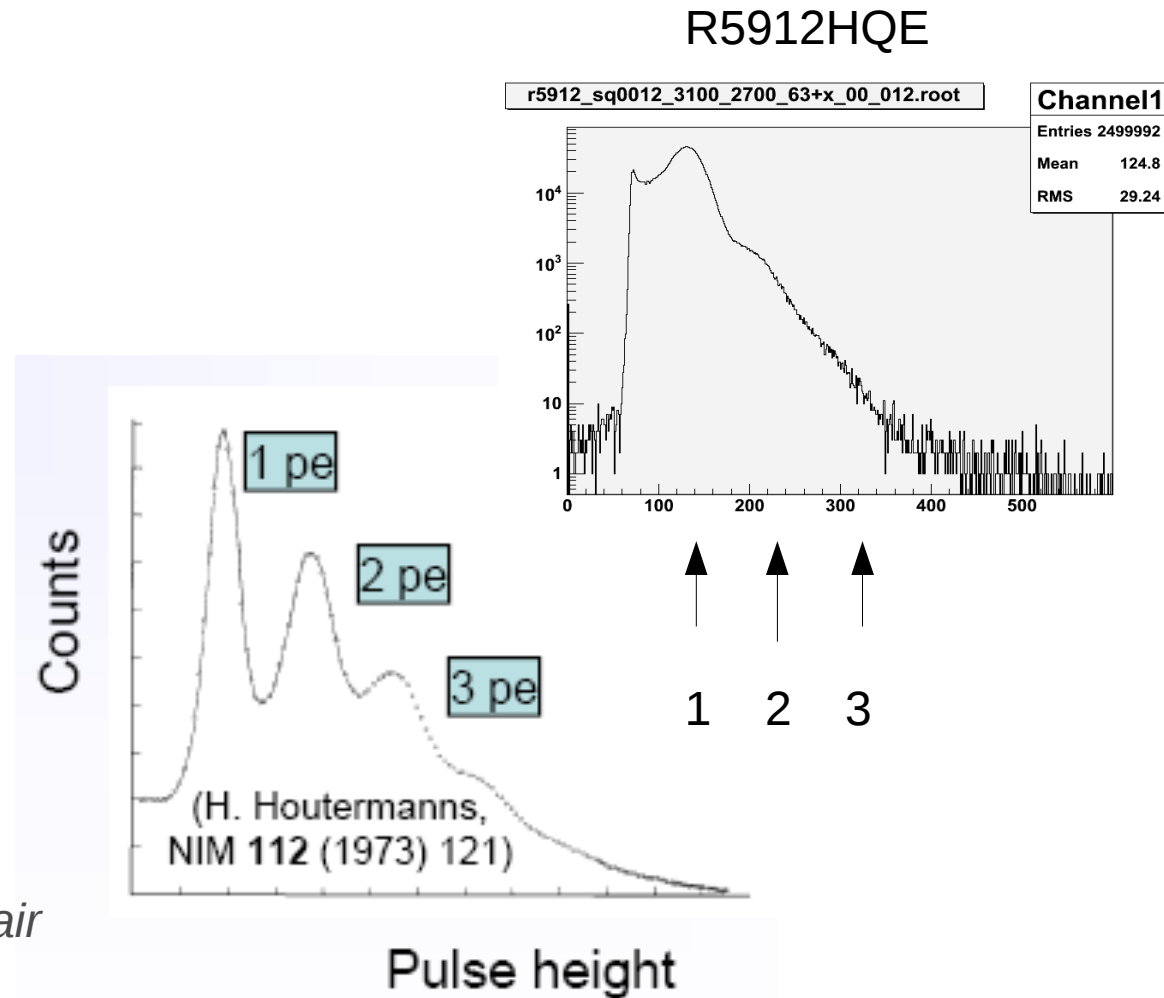

Fig.1.10 Secondary emission coefficient of GaP(Cs) as a function of incident primary-electron energy



*Note : Charge comparison is not quite fair ( low occupancy for R5912HQE )*

# “Smart PMTs” ( Electro-Optical PMTs, QUASARs )

- Lake Baikal, DUMAND ( now defunct ) ...
- Large photocathode plus very high voltage ( ~25 kV ) to focus PE onto scintillator
- Conventional small, flat faced PMT detects scintillation light

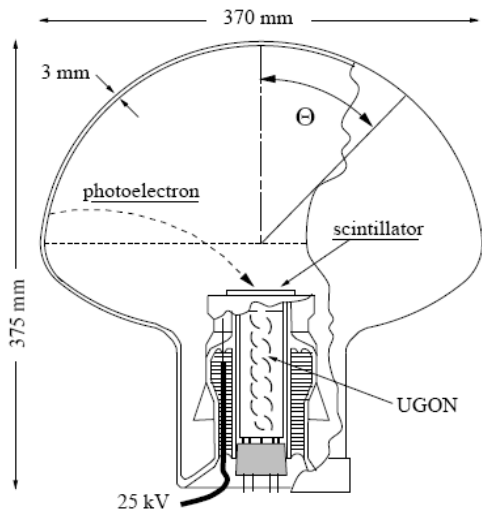

QUASAR-370

Generic PMT

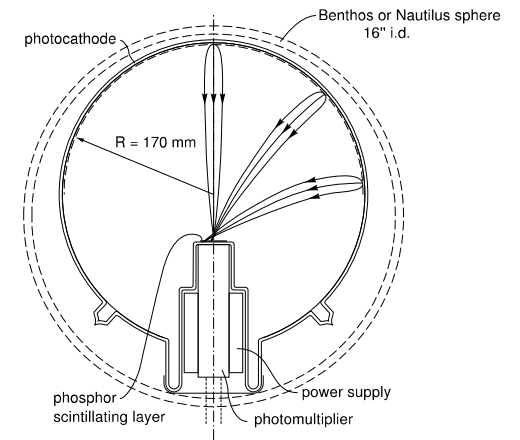
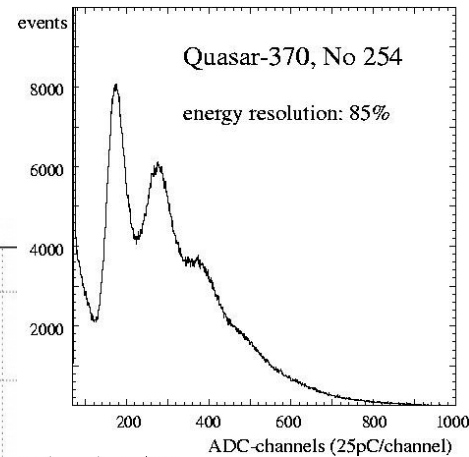
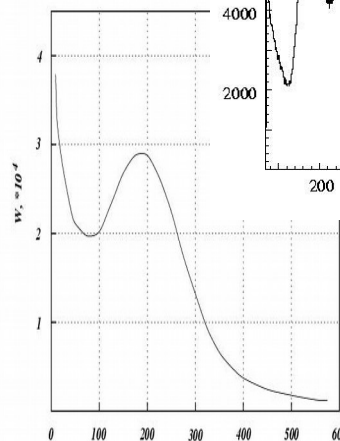

.18 Smart photomultiplier combination in a glass pressure sphere for deep underwater muon and neutrino detectors (DUMAND)

DUMAND

# Hybrids PMTs (HPDs)

- Combine PMT and semiconductor technology to improve performance ( *half and half ....* )
- Use “front end” PMT, high voltage and “back end” semiconductor
- Superb charge resolution – can easily separate 1,2,3, ... PE
- Claimed to have little afterpulsing ( *really ??* )
- Very good timing (  $\sim 50$  ps )



Hamamatsu 13" HPD

*Smart PMTs  
repackaged ....*

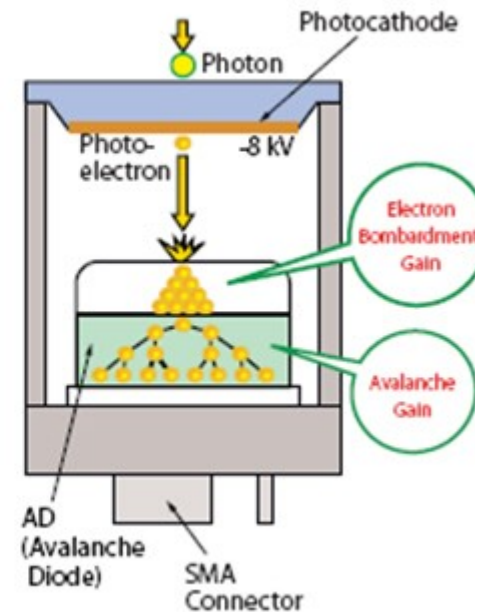

*8 kV voltage results in  
first stage gain of x 1600*

## Let us go back to solid state devices instead ...

- We've already ruled out photovoltaic devices as they're too slow and too low in gain
- We want a fast device with very high gain ( and low noise, etc., etc. )
- That brings us to reverse biased p-n junctions and thus APD's
- Doping and voltage controls performance

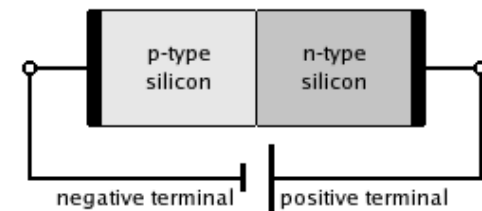
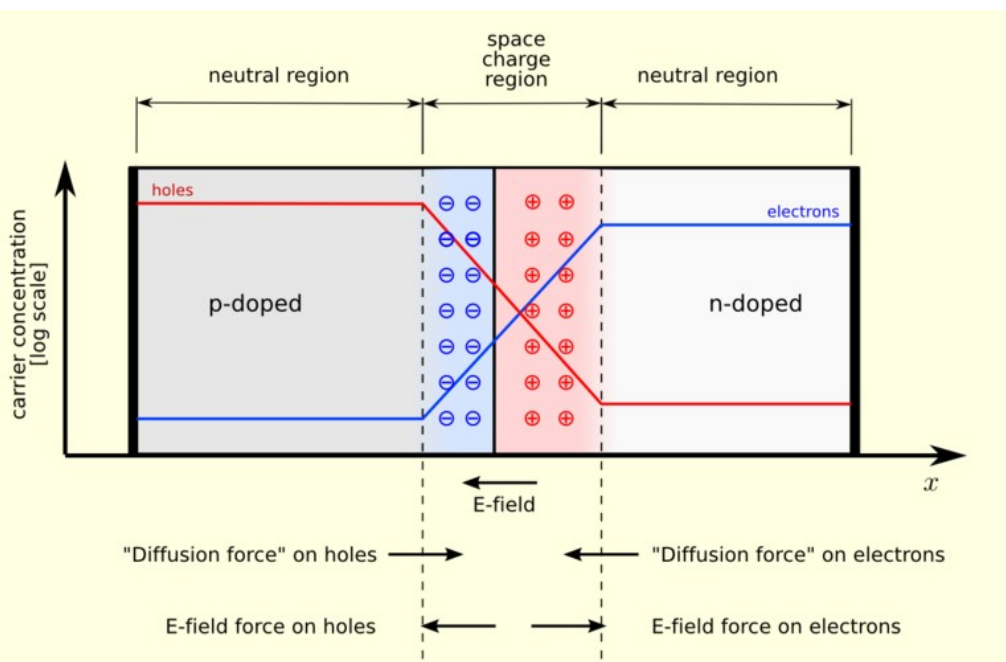

# APDs

- At high bias they will operate in Geiger mode, at lower bias they require tens of photons to trigger
- APDs are quite small (*usually a few mm dia. , maybe up to ~ 1 cm*)
- Usually high noise (*usually OK at cryogenic temperature*)
- Gain is lower than PMTs (*getting better as time progresses ...*)
- Very temperature dependent

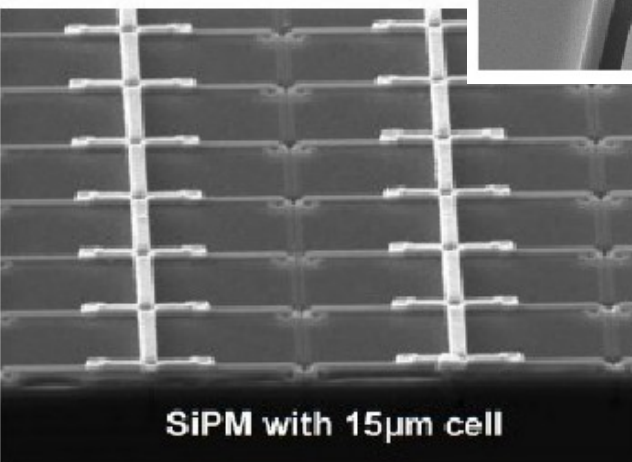
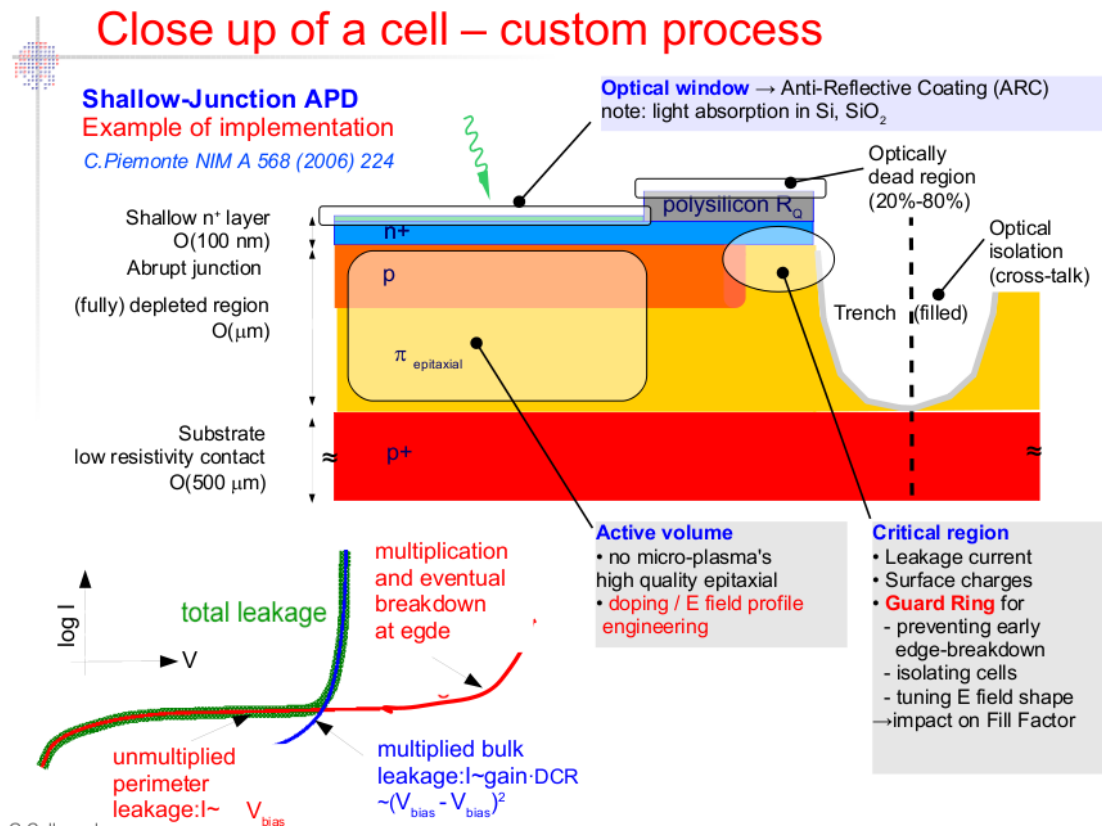
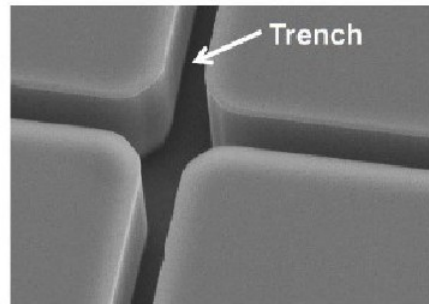

# SiPMs

- Large number of small ( 10-100 microns ) APDs mounted on a Si substrate operated in Geiger mode
- Also referred to as SPADs (*Single Photon Avalanche Diodes* ) , microcells or pixels
- Up to  $\sim 1000$  APDs per square mm
- Typically 35% QE,  $\sim 10$  ns timing,  $\sim 10^6$  gain

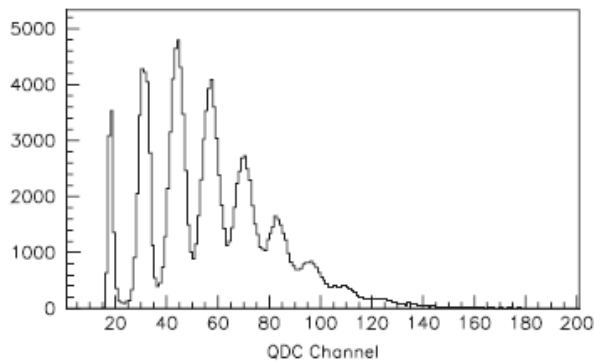

from V. Saveliev, NIM A  
**535**, 528 (2004)

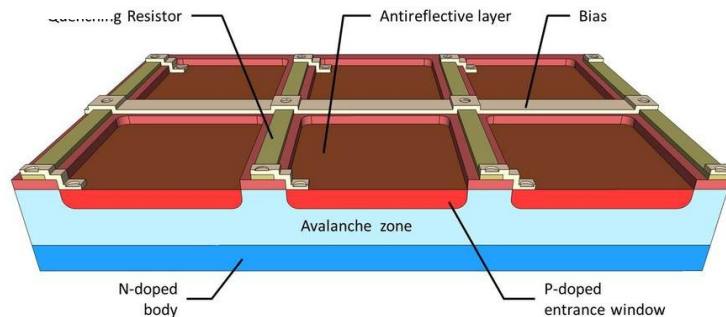
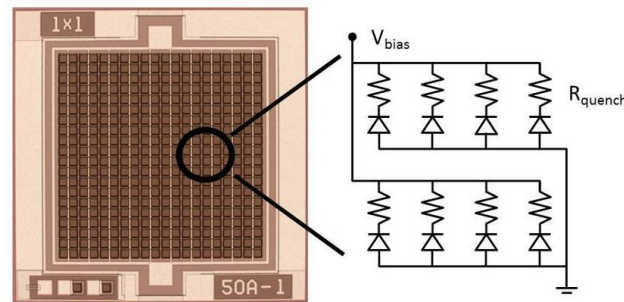

KETEK SiPM



# DarkSide-20K Photo Detector Module ( PDM )

DS-20k Photo-electronics)

~ 14 m<sup>2</sup> sensitive area

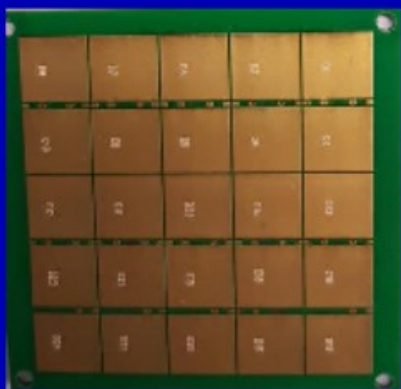

5210 tiles

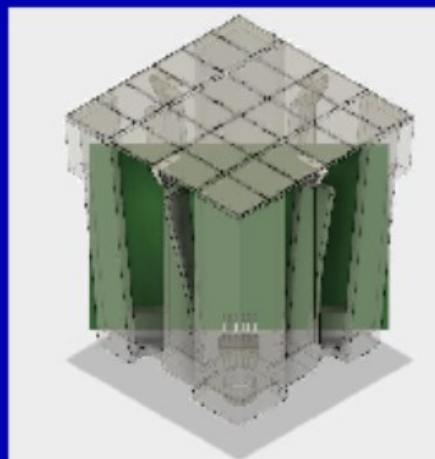

assembled in 5210 PDMs

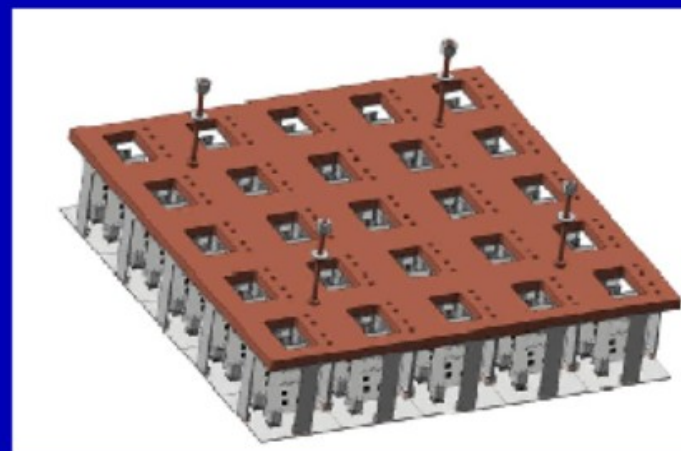

mounted on 240 Motherboards (208 triangular+ 32 squared ( 25 PDMs/MB ) ).

Keeping the number of channels @ 5210 implies the readout of 24 cm<sup>2</sup> SiPM tiles with a single channel

SiPM's from FBK ( Italy ) . Operated as analog devices

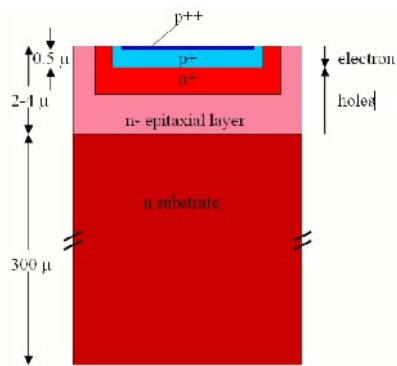

**Figure 2.5:** Architecture of an SiPM cell. The p on n structure light. Image from [9].

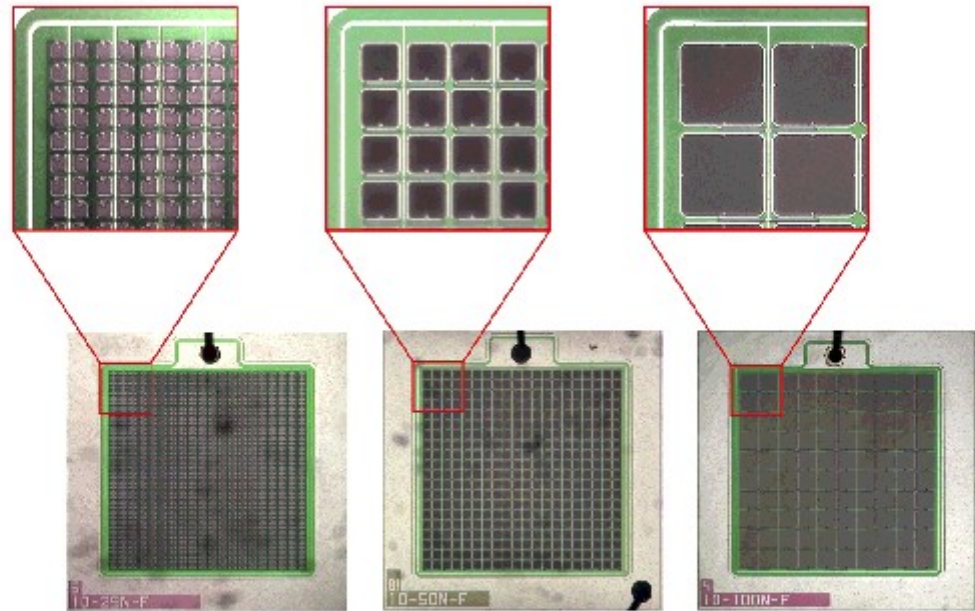

**Figure 2.7:** Magnified view of pixels in an SiPM. The black squares are the active area whereas the green spaces in between the cells are needed for quenching resistors and separation of the cells and cannot detect photons. Taken from [10].

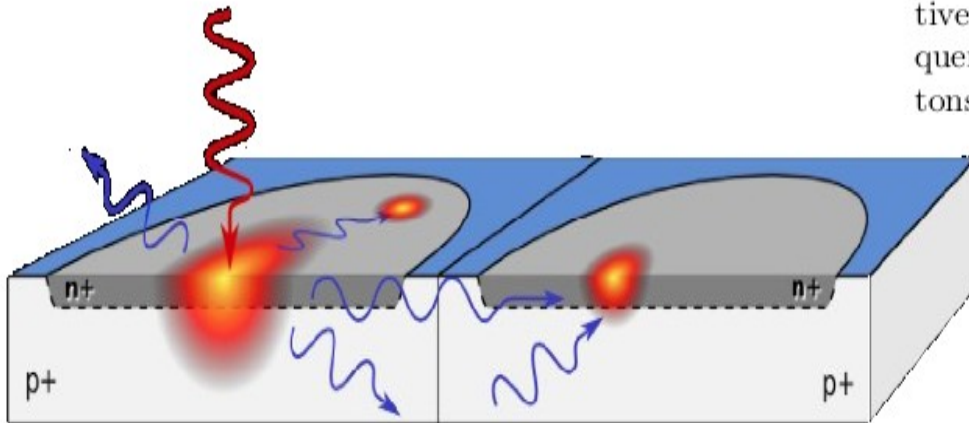

**Figure 2.11:** Schematic image of optical crosstalk in SiPMs. A photon coming from the initial avalanche enters an adjacent cell and triggers a secondary avalanche. Image adapted from [18].

Cross talk can be a problem

Electron-hole pair can be trapped at boundaries for hundreds of ns. Will cause afterpulsing

# Single Photon Avalanche Detectors

nEXO proposal ( U. Sherbrooke )

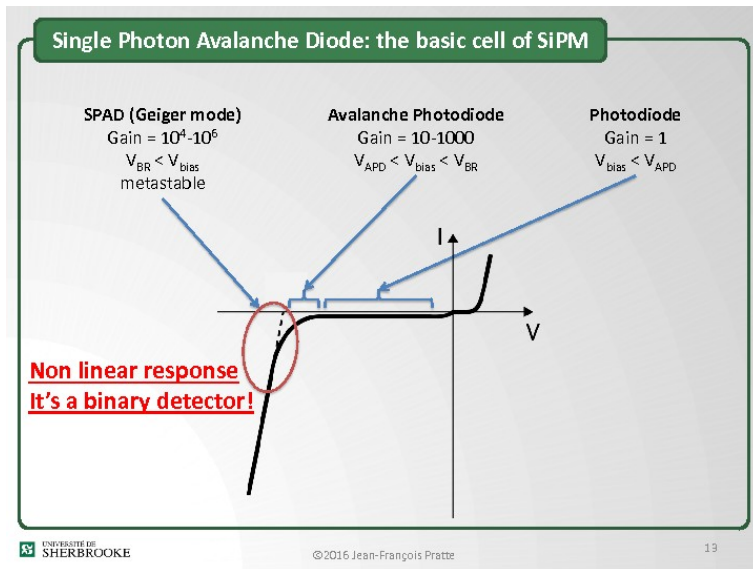

Operate each SPAD at very “high” voltage so that device effectively becomes digital in nature. Get a set of “1”s or “0”s from cells instead of analog signal.

Holy grail is to put everything including digital electronics on 3D tile . This will reduce noise and allow remote control over which cells to turn on and off.

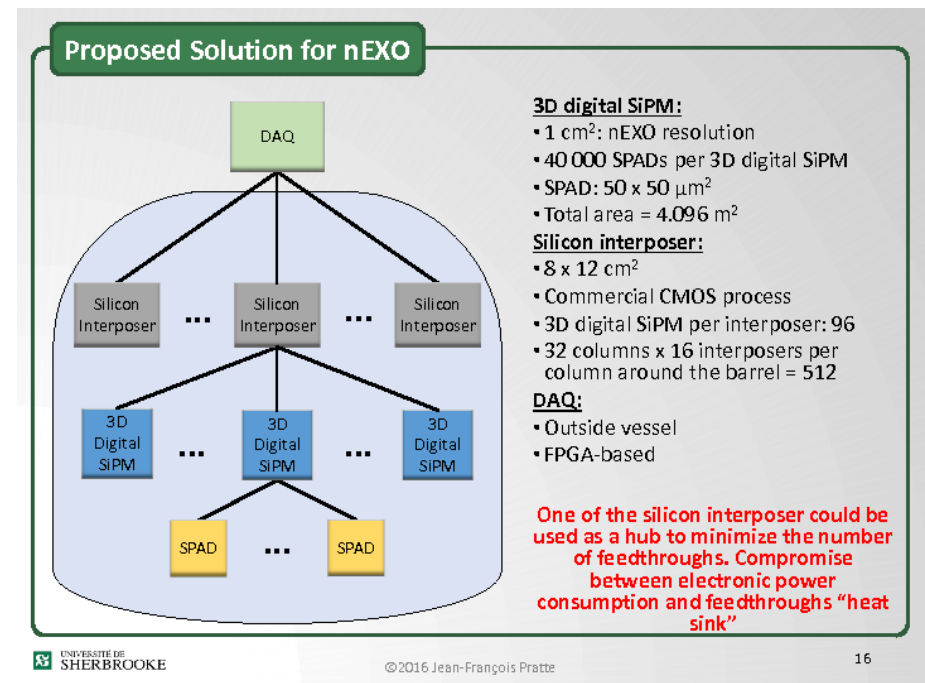

SIPM00 / PDM01

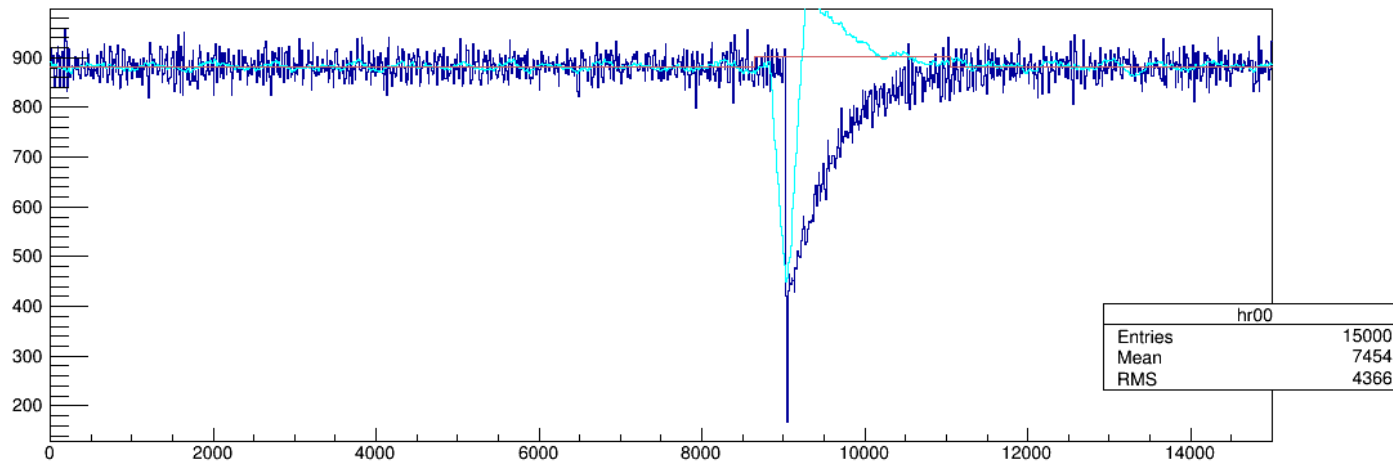

Cool single PDM to 77K, apply 6VoV, shine laser light on it, digitize output ( 250 MHz sample rate )

Blue trace is data, cyan is output of ( differential zero-crossing type ) pulse finder, red/brown is ZLE finder

Sharp spike followed by exponential looking tail ( recharge following avalanche breakdown )

Looks good ... ( *except that .....* )

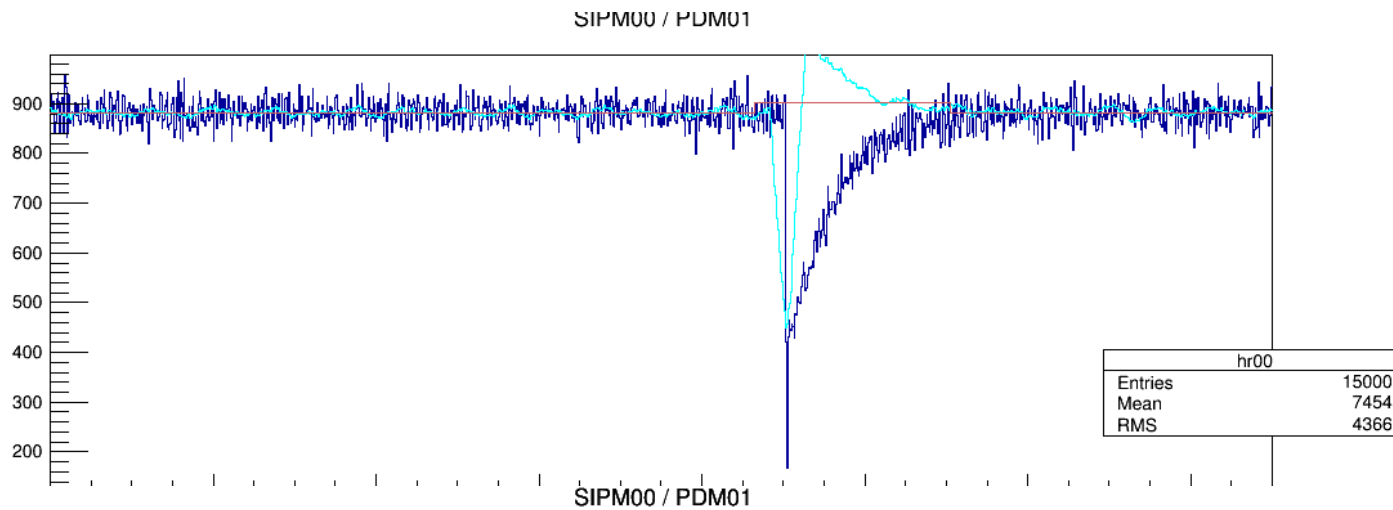

This is a ~10 PE signal !

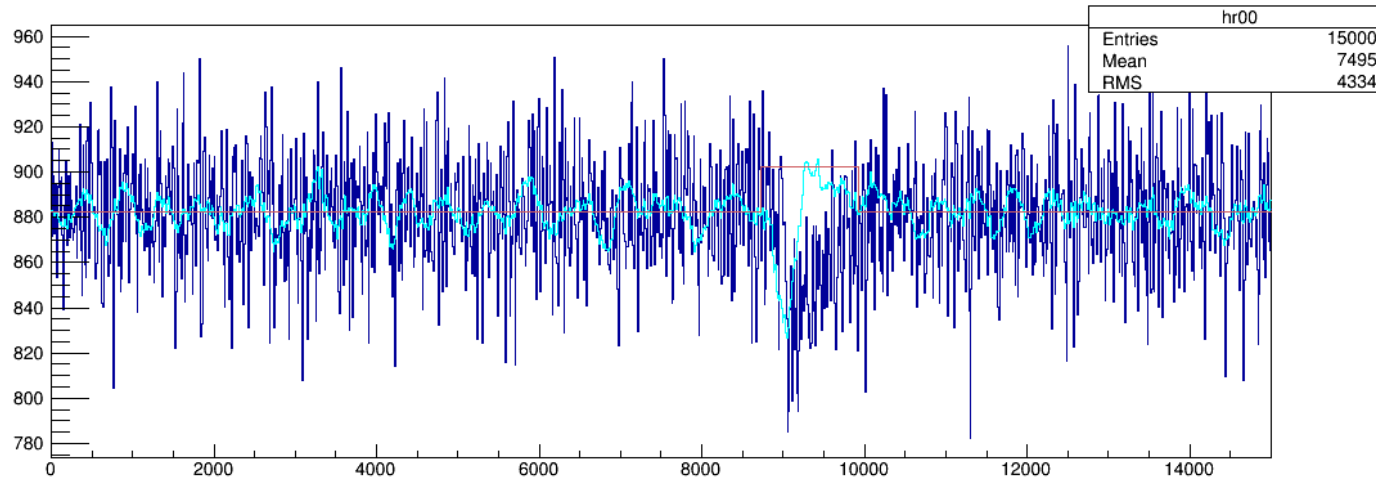

- and this is a 1 PE

Single PE are not easy to find. Signal to noise ratio is extremely important. We need to use all the tricks in the book to separate real pulses from noise. Exponential nature of response helps here.

SIPM00 / PDM01

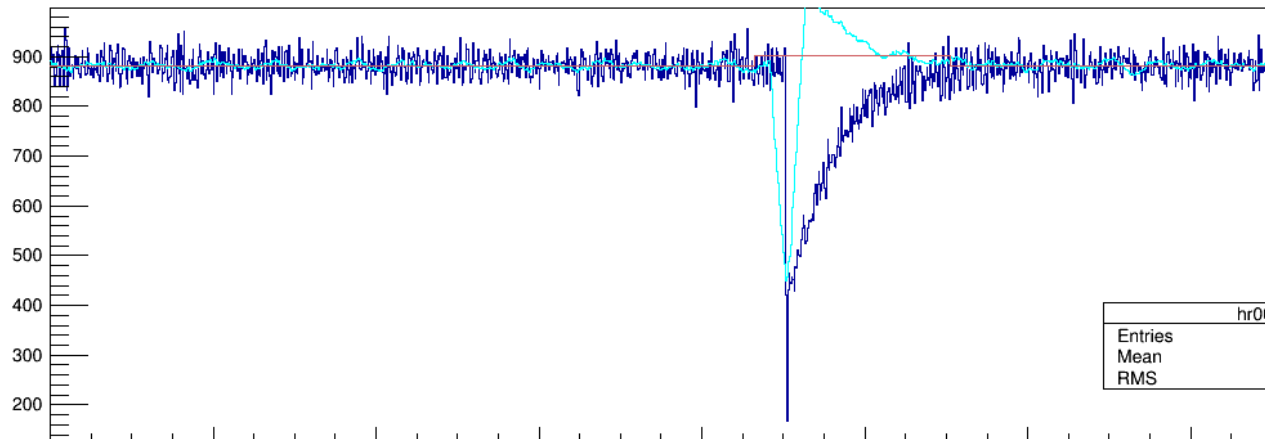

~10 PE

SIPM00 / PDM01

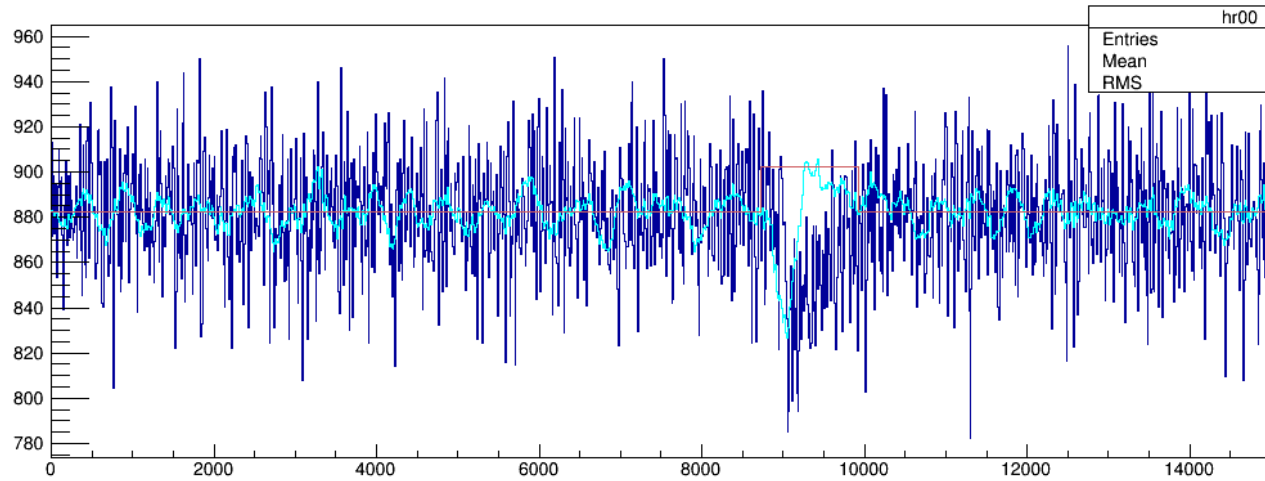

1 PE

SIPM00 / PDM01

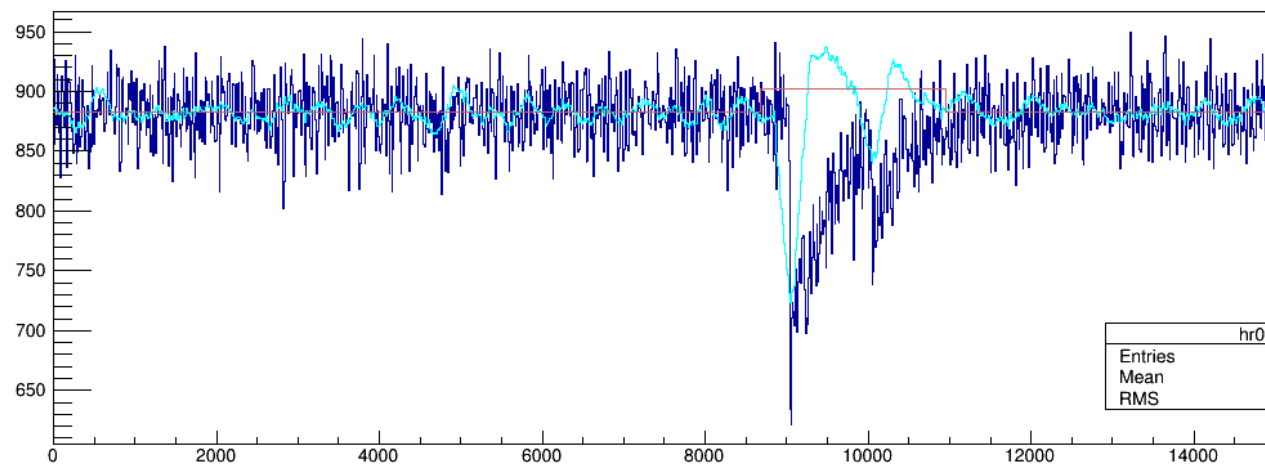

~4 + 1 PE

Afterpulsing event. Pulse height depends on state of recharge

# “Finger” plot

“0” photons



SIPM00 / PDM01

Q_prompt00	
Entries	200130
Mean	2249
RMS	1890

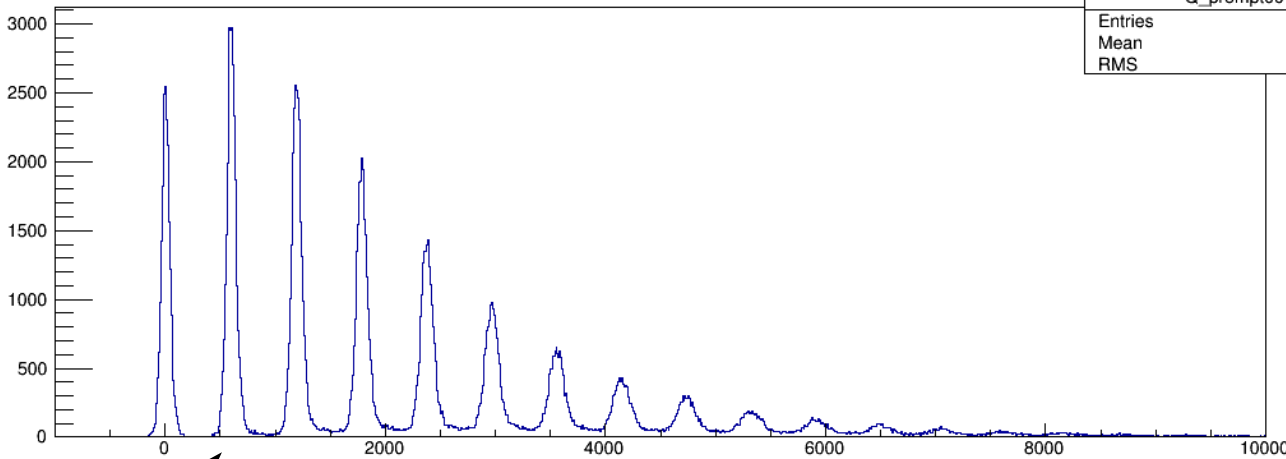

1 PE

2 PE

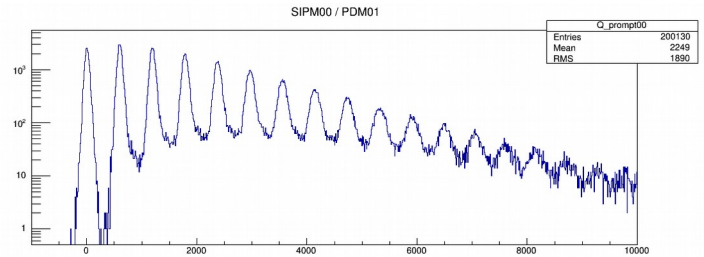

16 PE (!)

Just because we see events with ~ 16 PE doesn't mean we detected 16 photons ...

Mean number of photons on SiPM is estimated to be ~2

PE distribution is not Poissonian !

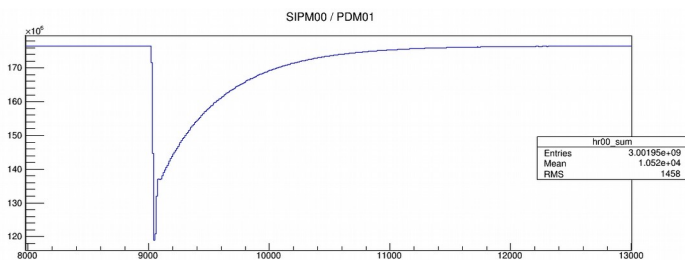

← Average pulse shape



First next-next generation “PDU Slim” prototype for DS-20K

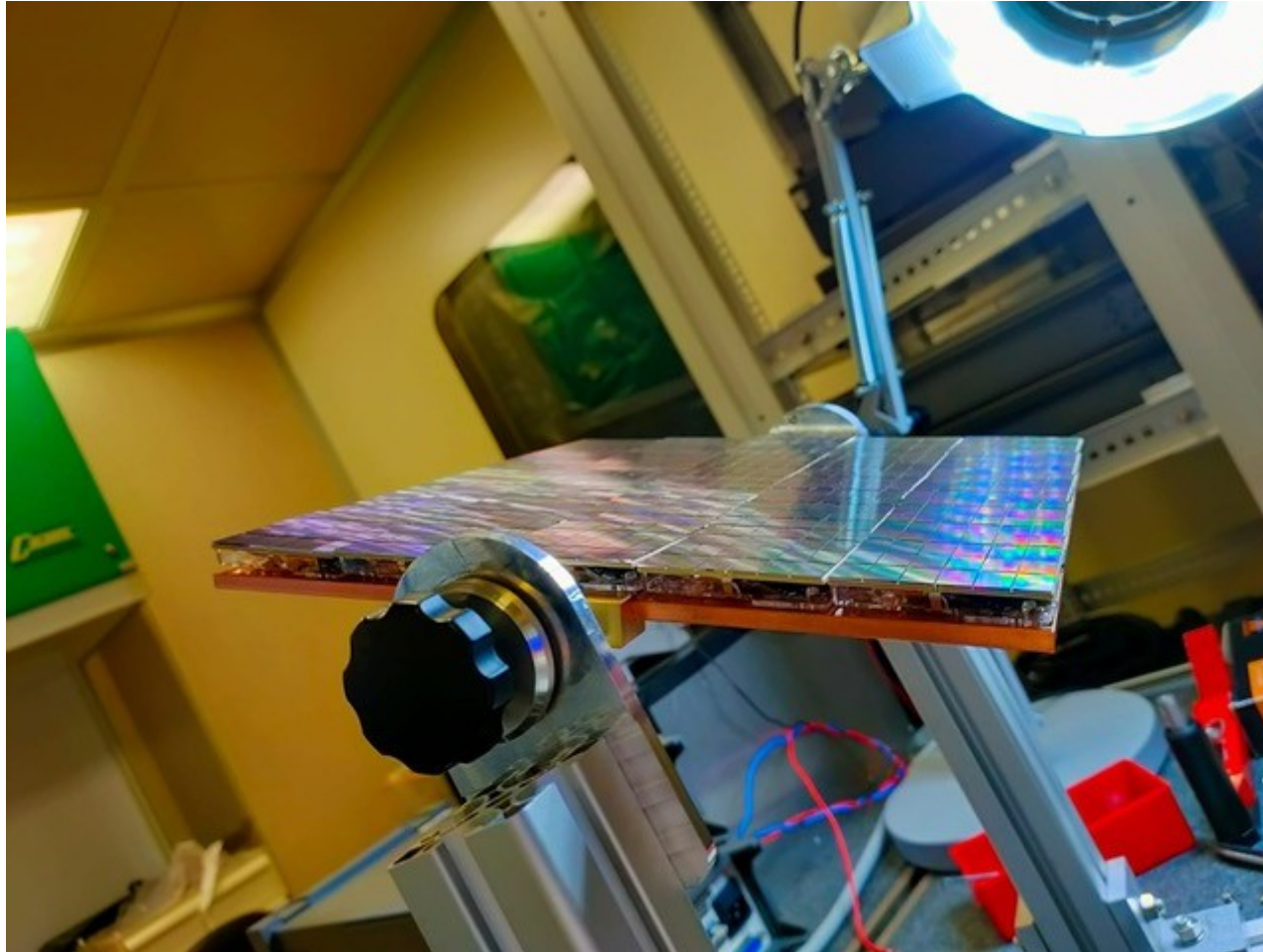

Being tested as we speak ...



# Mitigating cross talk is difficult ( “black magic” like photocathode “black magic” )

- isolate cells ( infilling )
- make device opaque to IR photons
- try to control diffusion of pairs from “dead” regions

....

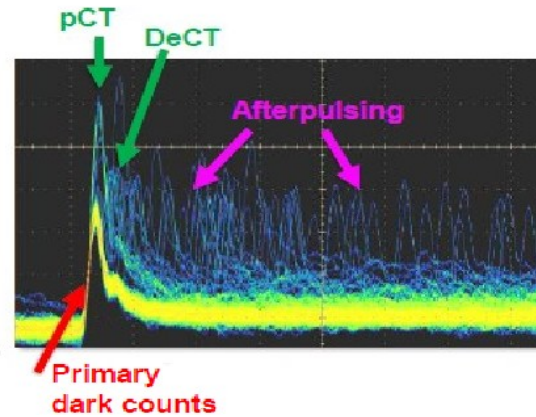
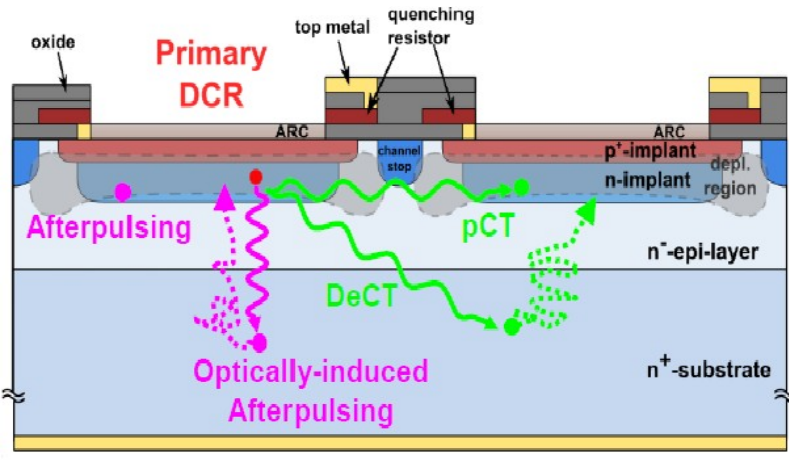

Develop statistical cascade model to correct charge response.

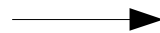

## Monte Carlo model

### Creation of primary and secondary pulses

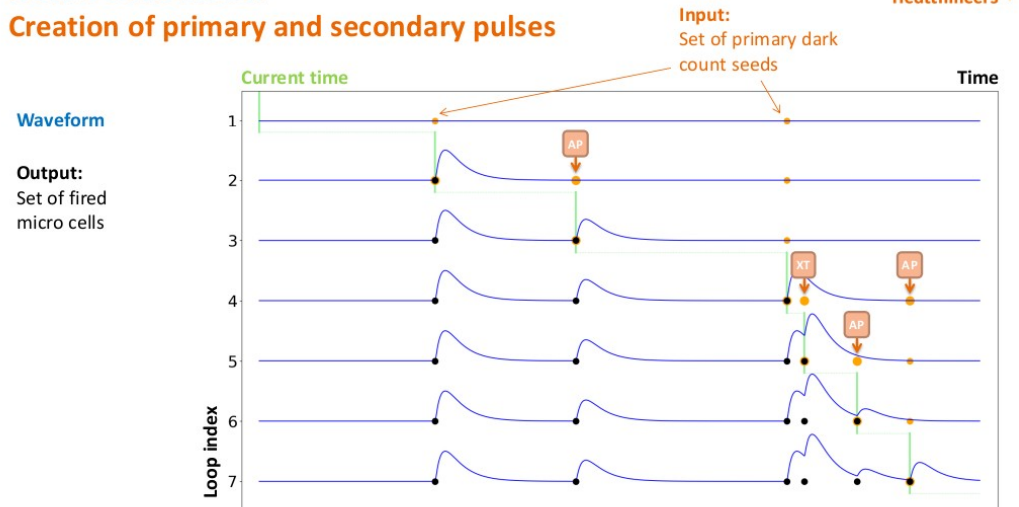

*The End ...*