

# Particle Identification

## Warwick week 2023

Antonis Papanestis  
RAL – STFC

# Outline

- Introduction
- Particle ID techniques:
  - Time of flight
  - dE/dx
  - Transition radiation
  - Cherenkov radiation
    - RICH detectors
    - DIRC detectors
- Give examples of experiments and detectors

# Introduction (i)

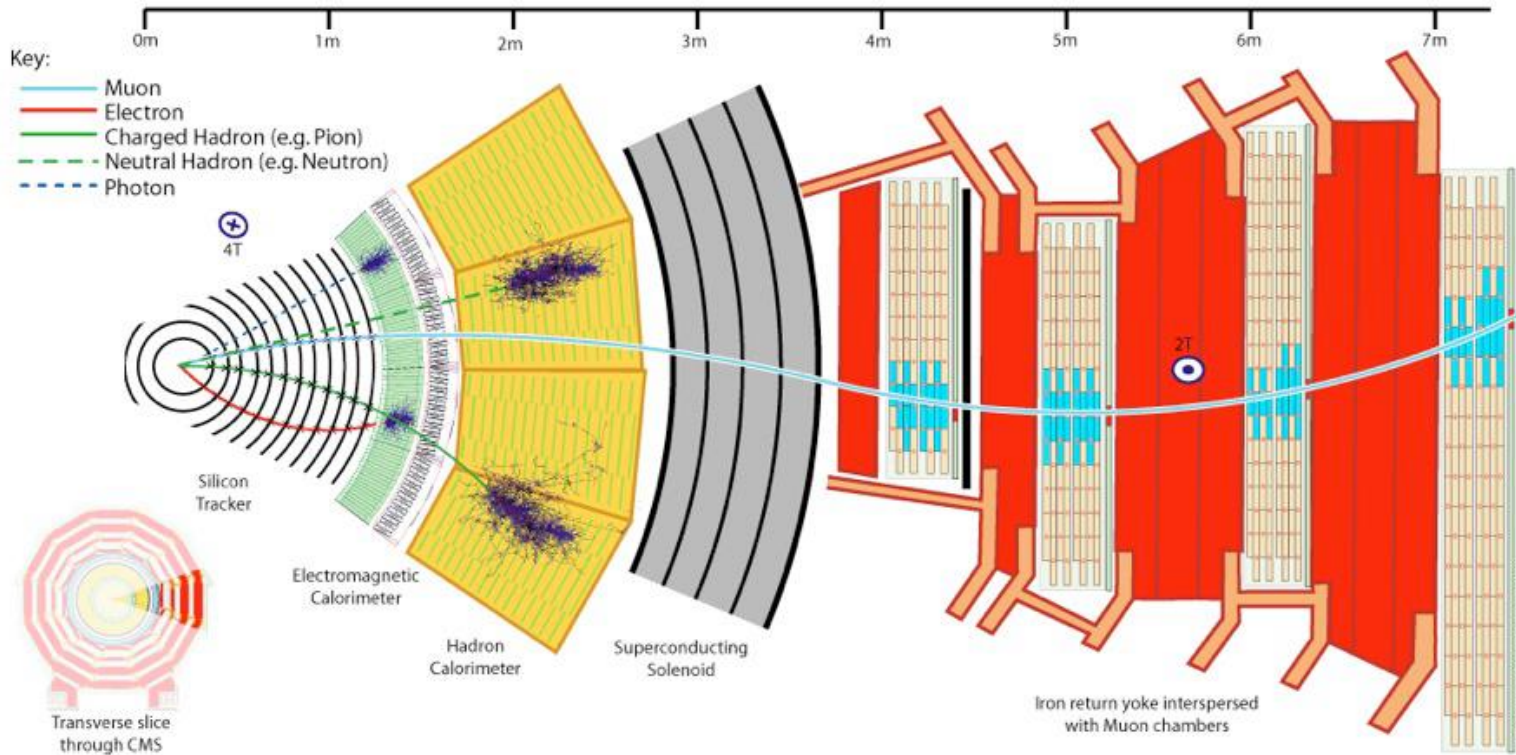

A “generic” particle physics experiment has “built-in” a lot of particle ID for:  
Electrons, photons, neutrons and muons

# Introduction (ii)

- Particle ID for hadrons
  - Distinguish between kaons, pions, protons, deuterons
    - Required for flavour physics
- Specific experiment requirements
  - Distinguish between electrons and charged pions
  - Distinguish between electrons and muons
    - For neutrino experiments
    - For rare decay searches

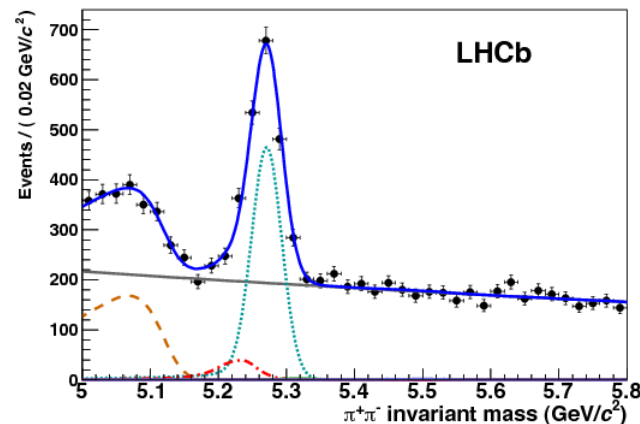
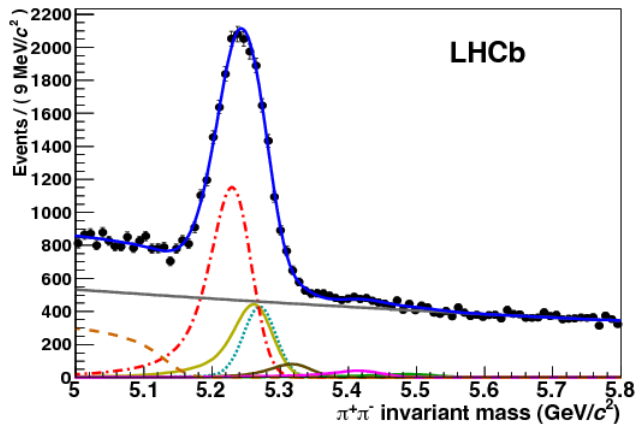

$B \rightarrow \pi^+\pi^-(h^+h^-)$  before and after RICH PID



# Detector technologies

## Practical Gaseous Ionisation Detection Regions

This diagram shows the relationship of the gaseous detection regions, using an experimental concept of applying a varying voltage to a cylindrical chamber which is subjected to ionising radiation. Alpha and beta particles are plotted to demonstrate the effect of different ionising energies, but the same principle extends to all forms of ionising radiation.

The ion chamber and proportional regions can operate at atmospheric pressure, and their output varies with radiation energy. However, in practice the Geiger region is operated at a reduced pressure (about  $1/10^{\text{th}}$  of an atmosphere) to allow operation at much lower voltages; otherwise impractically high voltages would be required. The Geiger region output does not differentiate between radiation energies.

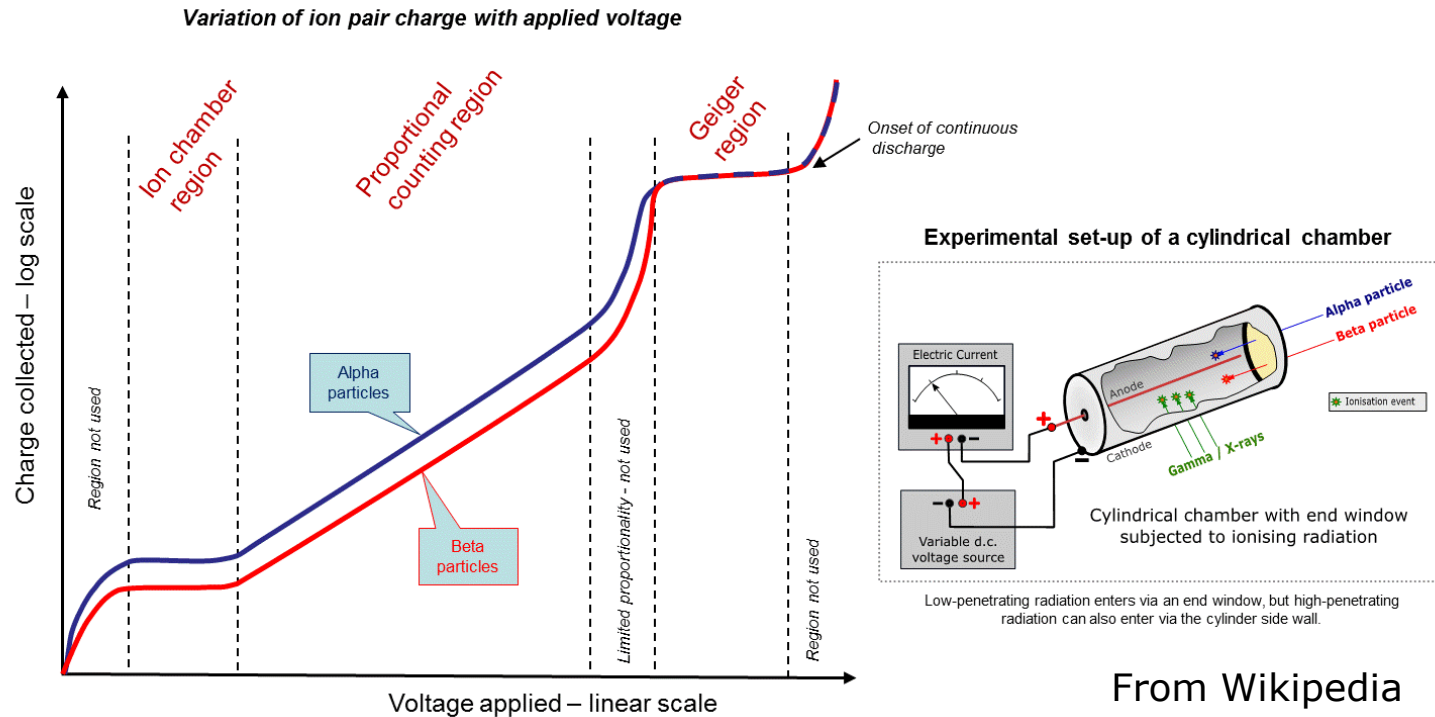

# Multiwire proportional chamber

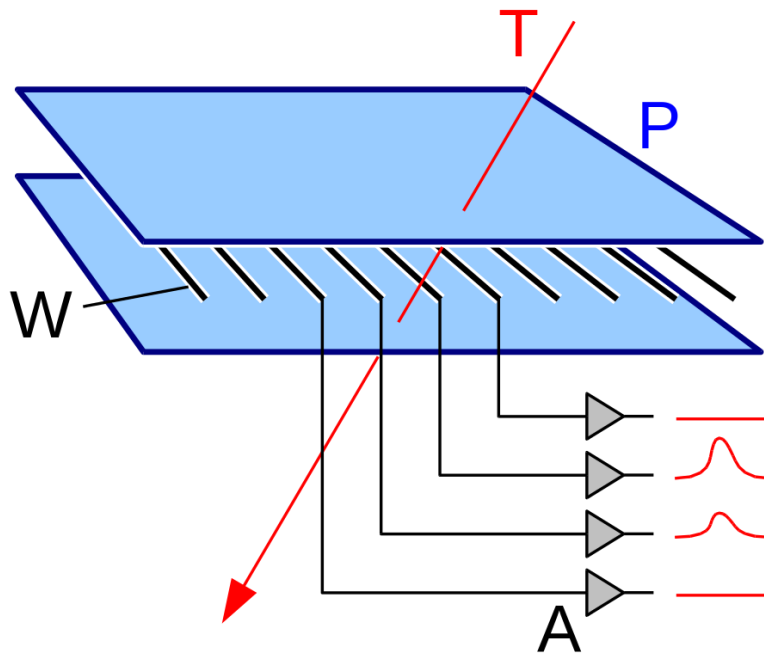

By Michael Schmid - CC BY-SA 3.0,  
<https://commons.wikimedia.org/w/index.php?curid=442715>

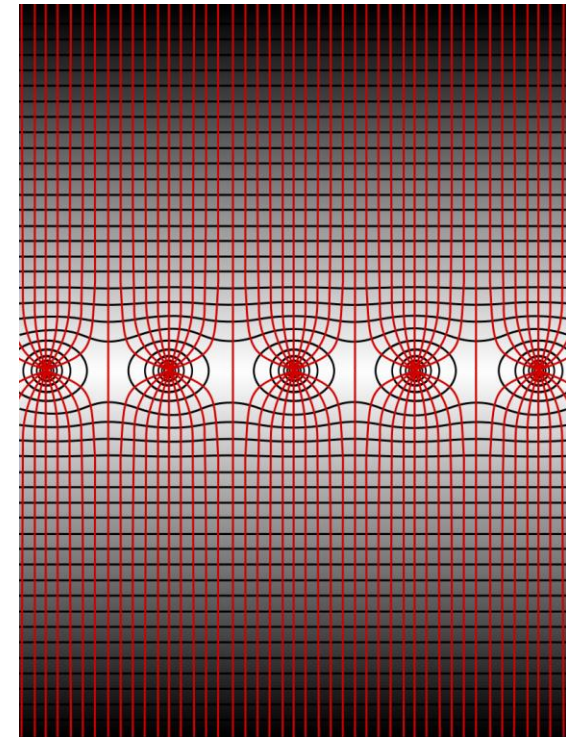

By Wiso - CC BY-SA 3.0,  
<https://commons.wikimedia.org/w/index.php?curid=2934457>

# Landau distribution

Energy loss due to ionisation

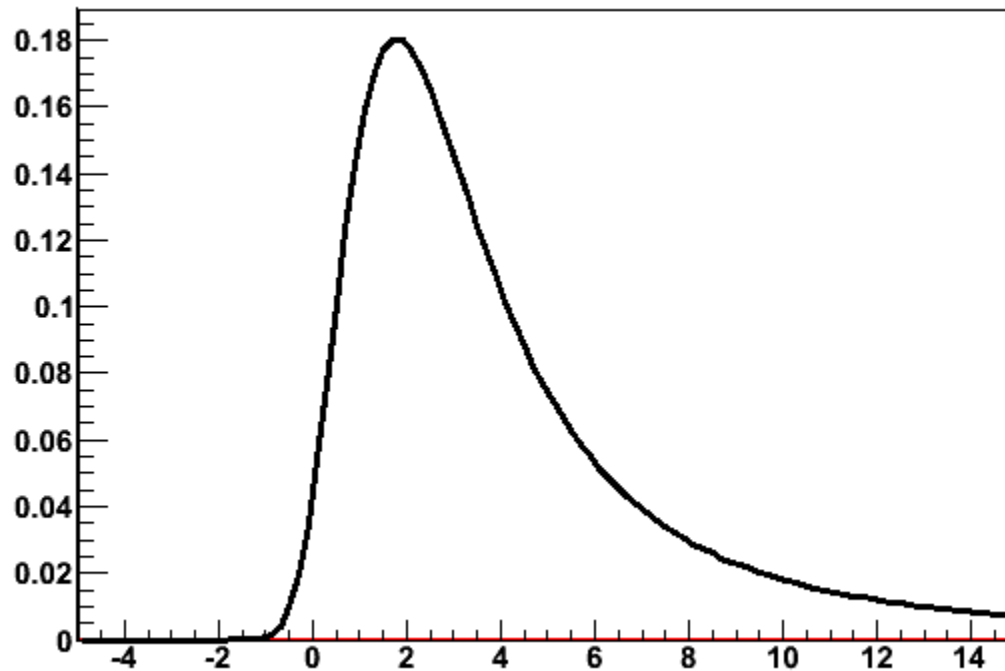

# Time of flight

Time difference for two particles with masses  $m_1$  and  $m_2$  for length  $L$  and momentum  $P$  (which is given by the tracking system)

$$\Delta t = \frac{L}{\beta_1 c} - \frac{L}{\beta_2 c} = \frac{L}{c} \left[ \sqrt{\left(1 + \frac{m_1^2 c^2}{P^2}\right)} - \sqrt{\left(1 + \frac{m_2^2 c^2}{P^2}\right)} \right]$$

$$P^2 \gg m^2 c^2$$

$$\Delta t \sim \frac{Lc(m_1^2 - m_2^2)}{2P^2}$$

Mass resolution depends on time resolution of detectors and distance  $L$   
Typical values:  $L=3.5$  m,  $\Delta t=100$  ps, for  $3 \sigma$  separation,  $P_{\max}=2.1$  GeV/c

Requires fast detectors: scintillation, Cherenkov, fast collection of ionisation





# PID with TOF

Expected PID performance for various path lengths and time resolutions

In 100 ps light travels 3 cm

TORCH, a proposed future detector, can push  $\pi/K$  separation to 9 GeV/c with  $L \sim 10$  m and time resolution per track  $\sim 20$  ps

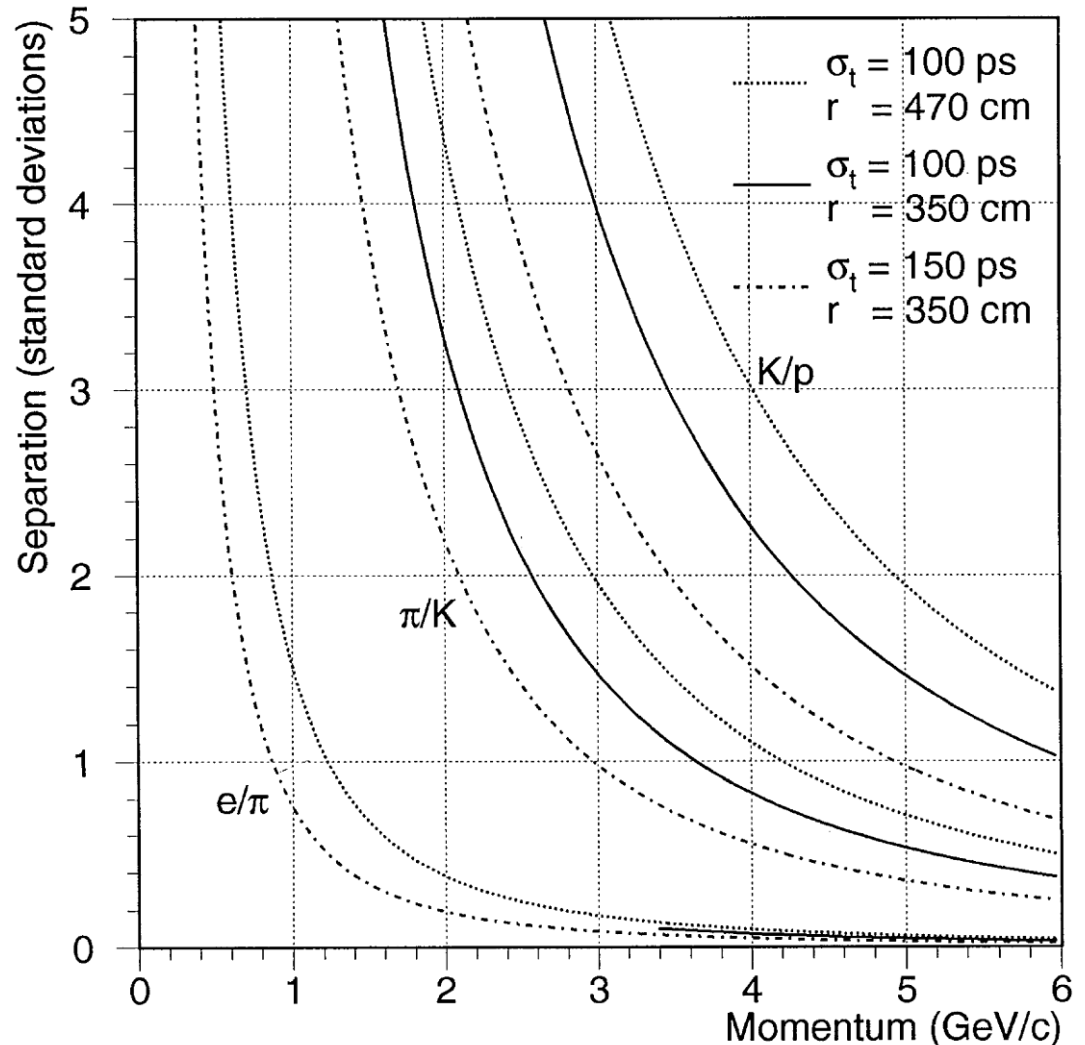

# TOF: ALICE experiment

[http://aliceinfo.cern.ch/Public/en/Chapter2/Chap2\\_TOF.html](http://aliceinfo.cern.ch/Public/en/Chapter2/Chap2_TOF.html)

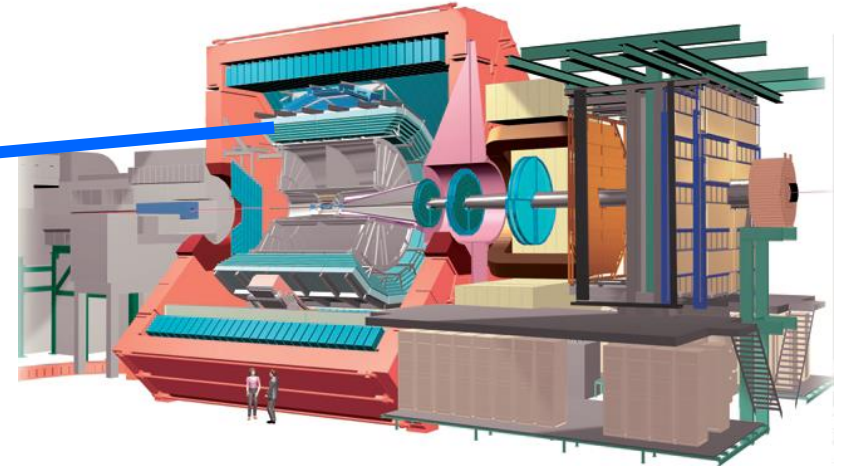
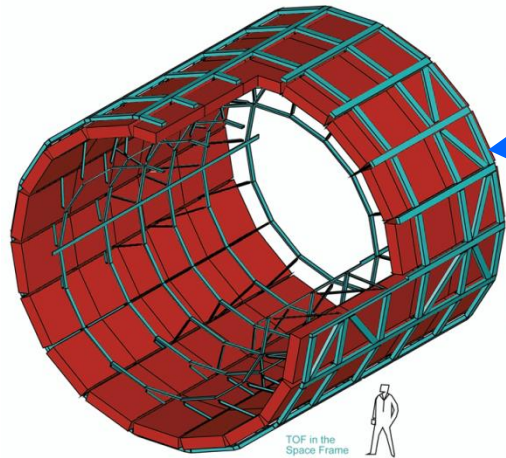

Resistive plates made of glass.  
2 X5 gaps : 250 mm  
Readout by HPTDC chip (High Performance Time to Digital Converter)

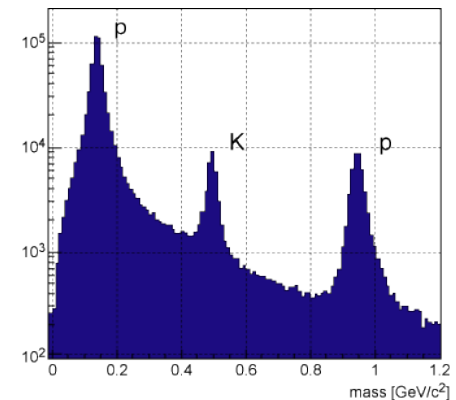
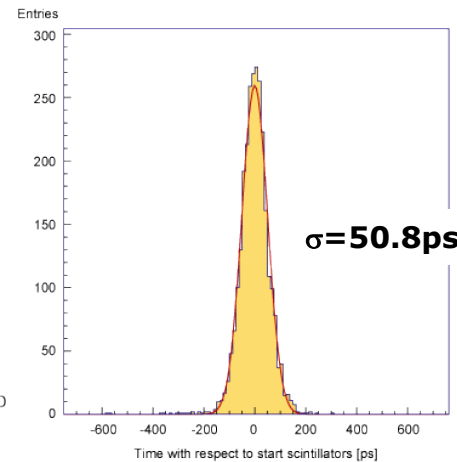
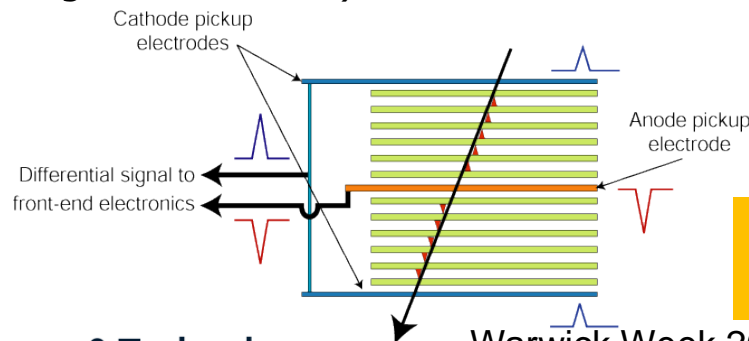

**3 $\sigma$  n/K separation up to 2.2 GeV/c  
and K/p separation up to 4 GeV/c.**



# Ionisation Measurement (dE/dx)

$$-\frac{dE}{dx} (\text{eVcm}^2\text{g}^{-1}) = Kq^2 \frac{Z}{A\beta^2} \left[ \frac{1}{2} \ln \frac{2m_e c^2 \beta^2 \gamma^2 T_{\max}}{I^2} - \beta^2 \frac{\delta(\beta\gamma)}{2} \right]$$

Ionisation Constant for material

Density correction

$$T_{\max} \approx 2m_e c^2 \beta^2 \gamma^2$$

Max energy in single collision

$$K = 4\pi N r_e^2 m_e c^2$$

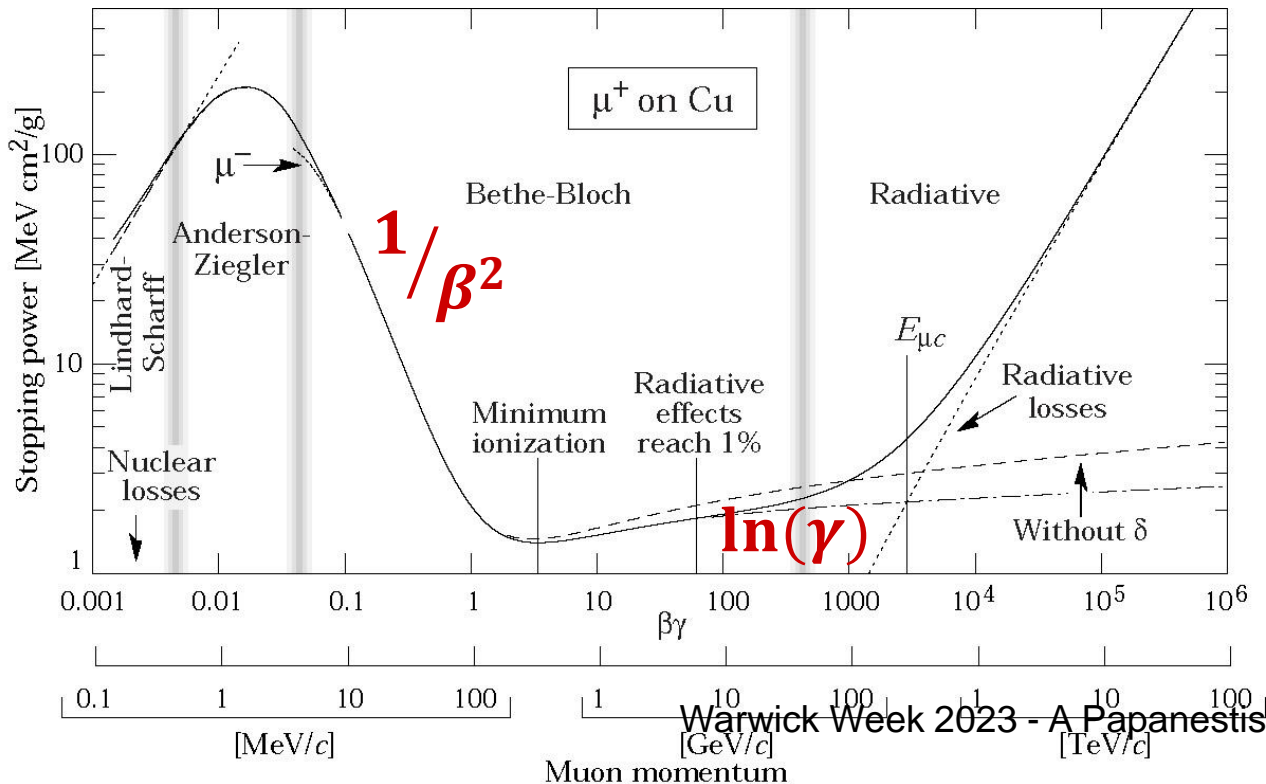

# dE/dx in silicon

Bethe-Block formula (for  $2\gamma m/M \ll 1$ )

$$\frac{dE}{dx} = \frac{4\pi N e^4}{m c^2 \beta^2} Z^2 \left( \ln \frac{2 m c^2 \beta^2 \gamma^2}{I} - \beta^2 \right)$$

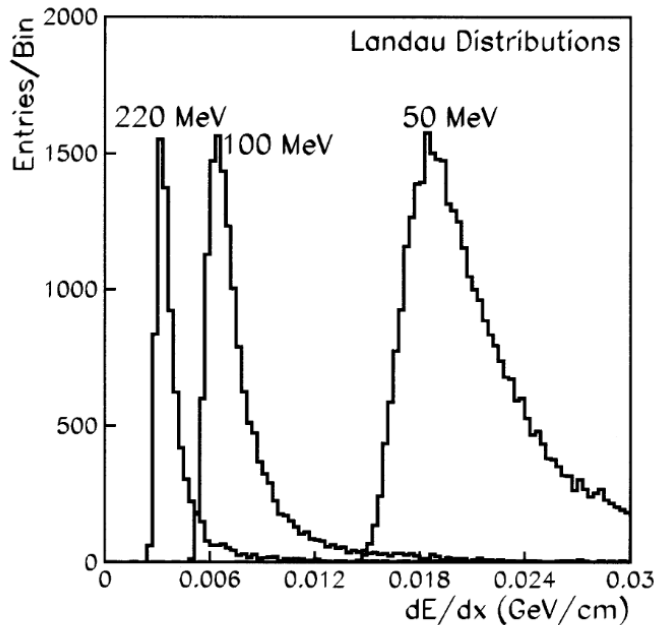

Fig. 1. Landau  $\langle dE/dx \rangle$  distributions for pions of momenta 220, 100 and 50 MeV going through 300  $\mu\text{m}$  of silicon.

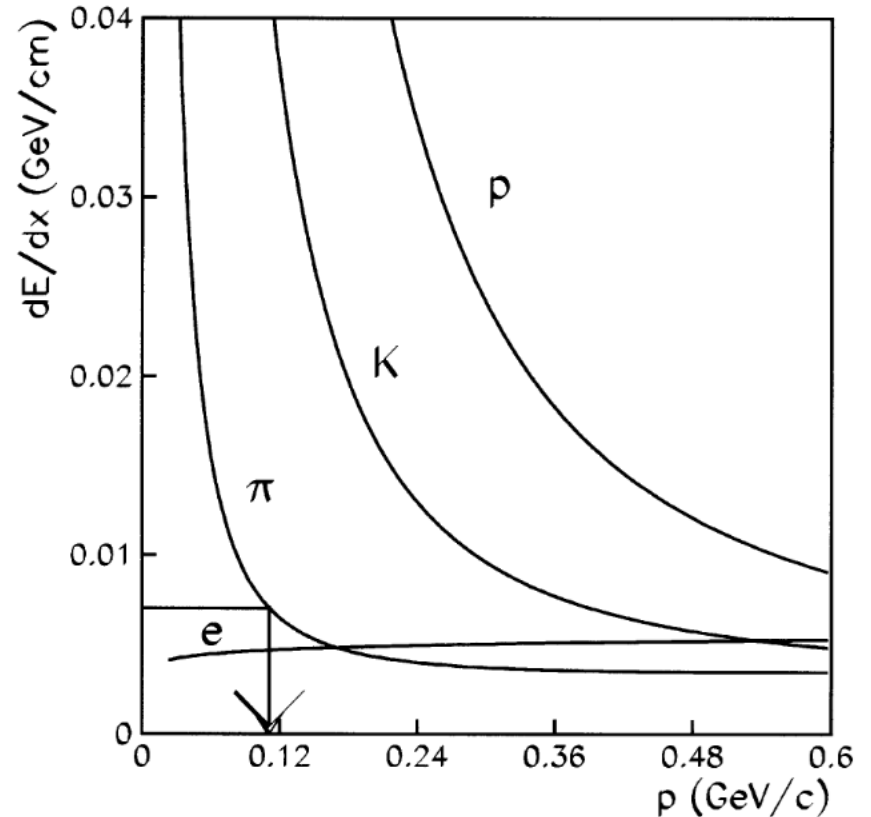

Fig. 3.  $\langle dE/dx \rangle$  as a function of momentum in STAR-SVT. For low momentum pions one can use the pion curve to extract the momentum from the measured  $dE/dx$  as shown.

Ref: NIMA 469(2001) 311-315



# dE/dx: CMS Si tracker

- Each Silicon sensor gives a dE/dx measurement.
- Estimate the Most Probable Value from several (10-25) measurements (Truncated Mean: Ignore upper 40%)

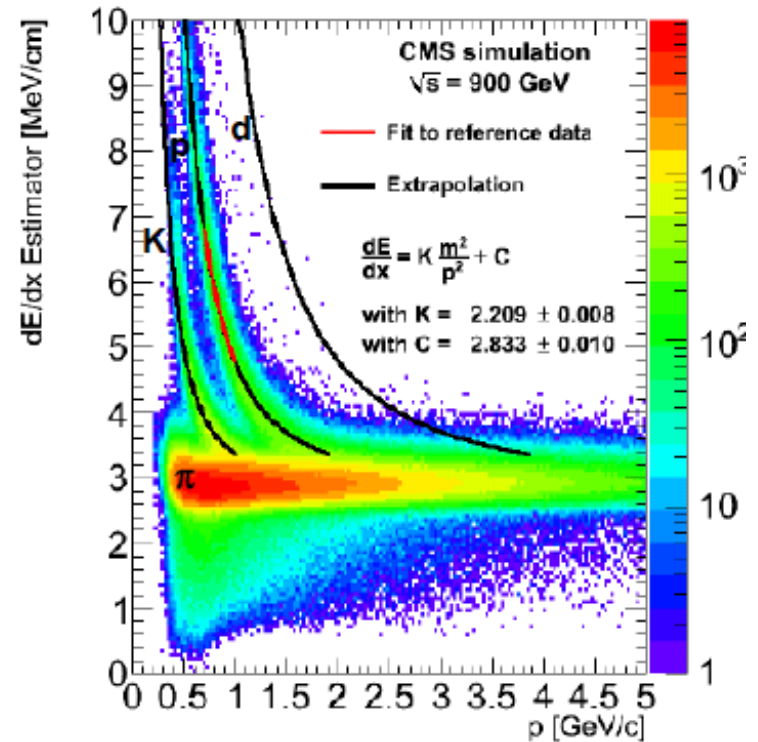
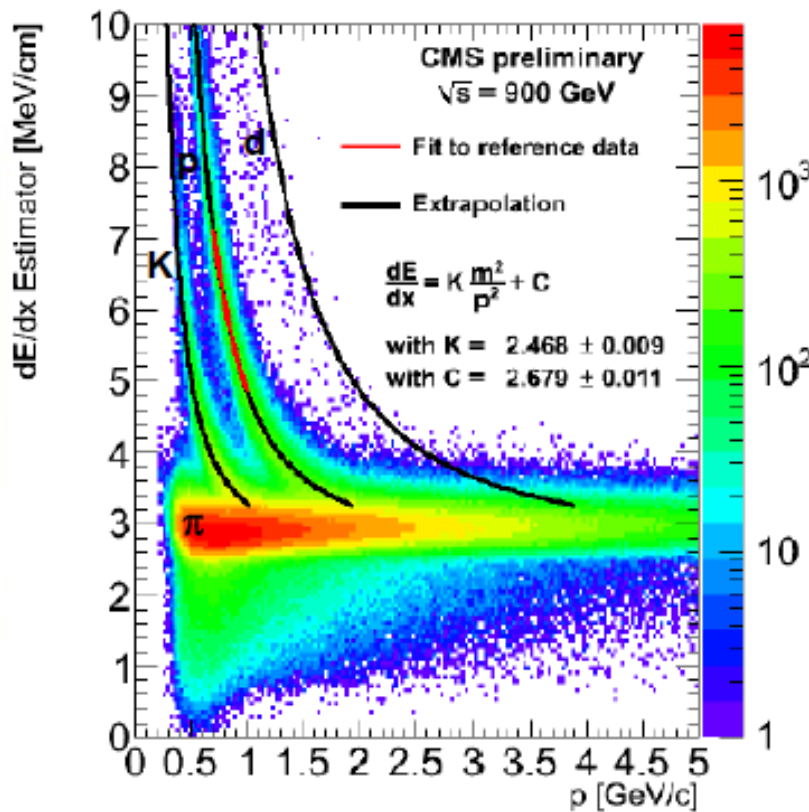

Data

Warwick Week 2023 - A Papanestis

MC

# Drift chambers

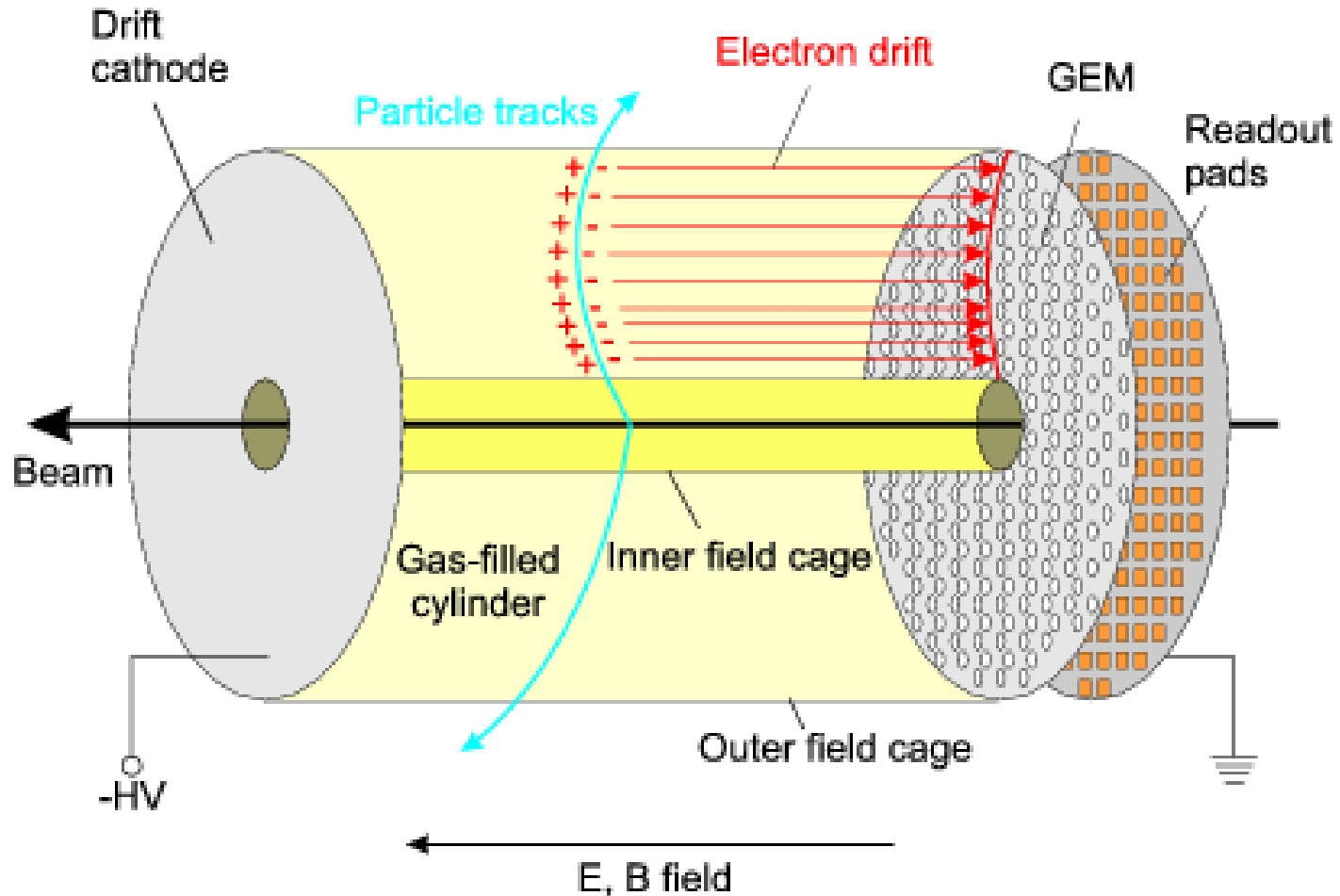



# dE/dx : Drift Chambers

Larger Landau fluctuations compared to those from Silicon detectors.  
 So many measurements needed to get the average.

Ref: IEEE-TNS VOL:47 , NO:6, Dec2000.

BABAR Drift Chamber:

Gas mixture 80% helium, 20% isobutane,  
 3500–4000 ppm water vapor,  $\sim 80$  ppm  $O_2$

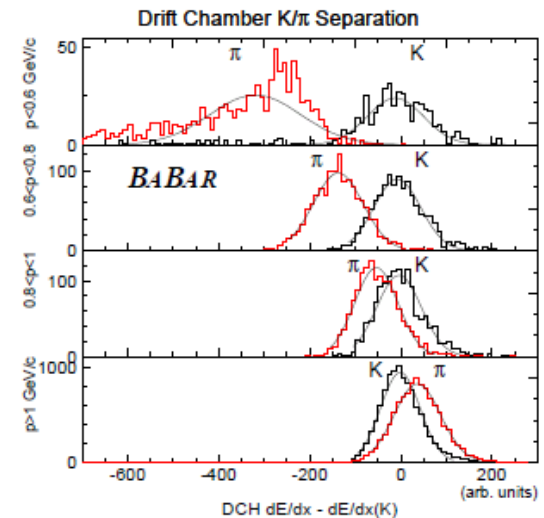
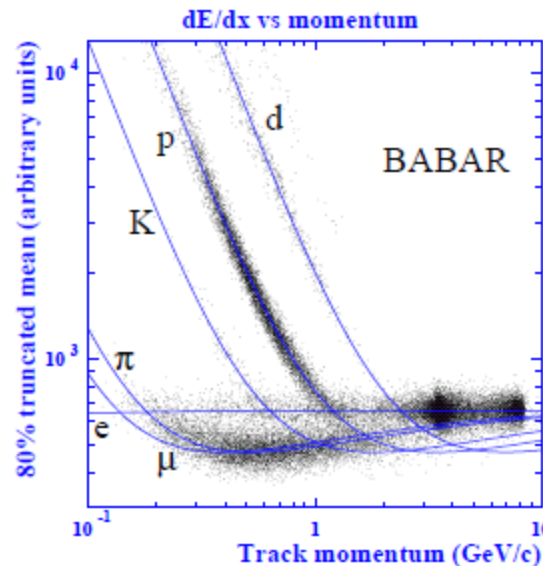
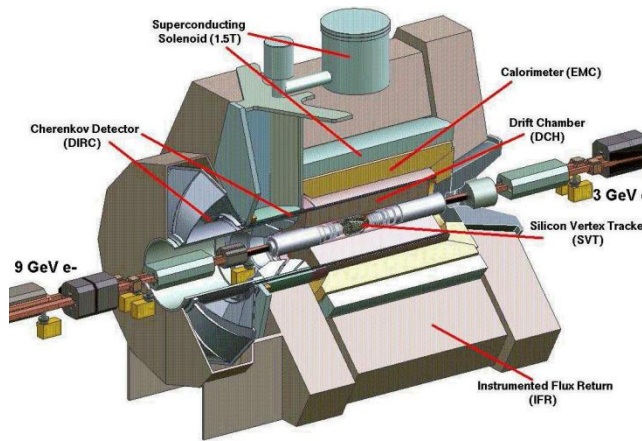

Good  $\pi/K$  separation up to  $\sim 700$  MeV/c.  $dE/dx$  resolution  $\sim 7.5\%$

# Combined TOF and dE/dx

NA 49: Heavy ion experiment,

TOF: Scintillator thickness=2.3 cm, time resolutions= 59 ps, 95 ps

TPC for dE/dx.

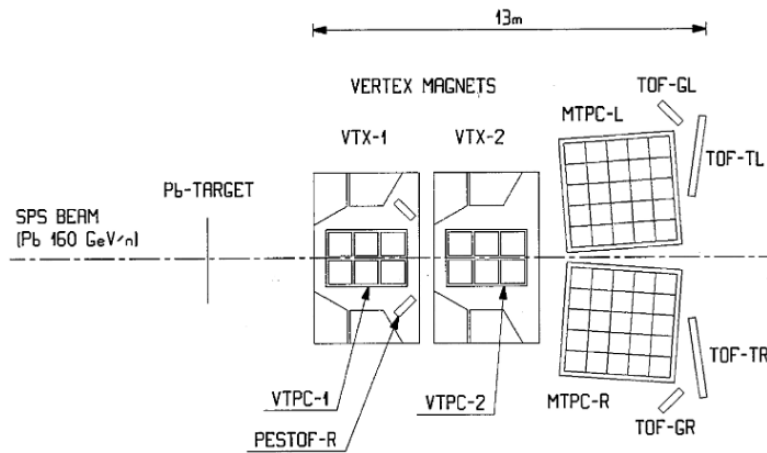

Fig. 2. Central part of the NA49 experimental setup.

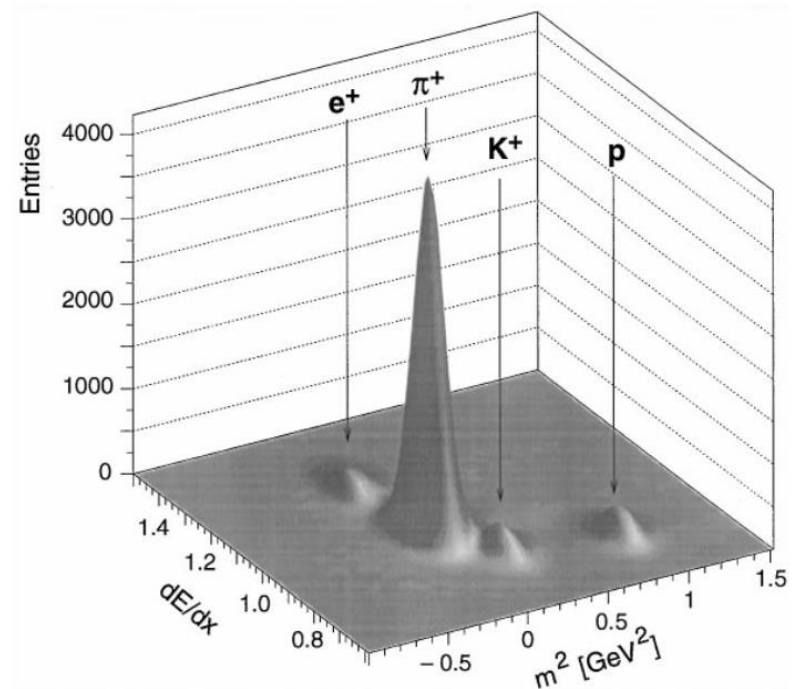

Fig. 5. Particle separation in NA49 with combined dE/dx and TOF information.



# Transition Radiation (TR)

- Transition Radiation: Radiation in the x-ray region when ultra relativistic particles cross the boundary between 2 media with different dielectric constants.
- Mainly for  $e^-$  separation in  $0.5 \text{ GeV}/c \rightarrow 200 \text{ GeV}/c$ .

Full explanations and the derivations from Maxwell's equations:

NIMA 326 (1993) 434-469 and references there in.

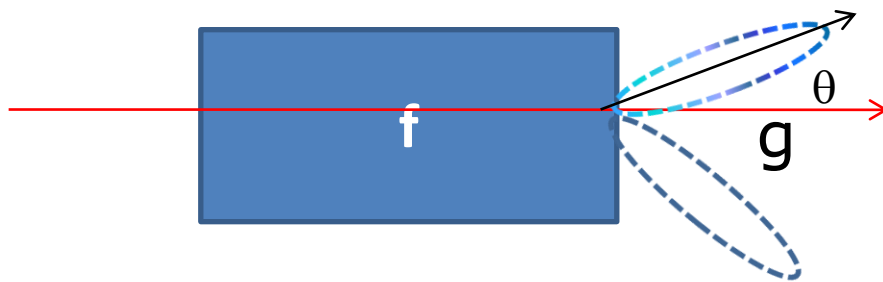

The radiation is peaked at a small angle:

$$\theta = 1/\gamma$$

$$\frac{dW}{d\omega d\theta} = \frac{2\alpha}{\pi} f_0(\theta)$$

$$f_0(\theta) = \theta^3 \left( \frac{1}{\gamma^{-2} + \theta^2 + \xi_g^2} - \frac{1}{\gamma^{-2} + \theta^2 + \xi_f^2} \right)$$

$$\xi_i = \omega_i/\omega \quad \omega_i = \text{plasma freq of medium } i$$

# TR Detection

Integrating the previous equation, one can get , for  $\xi_g=0$ ,

$$W_{TR} = 2.43 \times 10^{-3} \omega_f \gamma$$

- $\gamma = E/m$  of the particle. This makes PID possible by measuring W.
- Lighter particle give larger signal
- $\omega_f =$  plasma frequency =  $28.8 (\rho Z/A)^{0.5}$  eV  
 $\rho$ =density,  $Z$ =atomic weight,  $A$ =atomic number

For example, for  $\omega_f = 0.02$  keV and  $\gamma = 5000$ , most of the photon energy is in the range  $10 \text{ keV} < \omega < 100 \text{ keV}$  (ie.  $0.1 \omega_c < \omega < \omega_c$  where  $\omega_c =$  cut-off frequency ).

$$\text{Number of photons produced} = N(> \omega) = \frac{\alpha}{\pi} \left\{ \ln \frac{\omega_c}{\omega} \left( \ln \frac{\omega_c}{\omega} - 2 \right) + \frac{\pi^2}{12} + 1 \right\}$$

For  $\omega_c=100$  keV and  $\omega=1$  keV,  $N= 0.03$  for a single surface.

Hence to get sufficient number of photons , large number of interfaces are used: a stack of many foils with gaps in between.

# TRD Example 1: HELIOS experiment (NA34)

- The minimum thickness of the foils and air gaps are determined by the size of the 'formation zone' and the interference effects.  
( typically, foils can be 10-20  $\mu\text{m}$  thick and are made of polypropelene)
- Behind a TRD foil stack there is a MWPC or drift chamber where the TRD signal is detected along with the signal from the charged track.

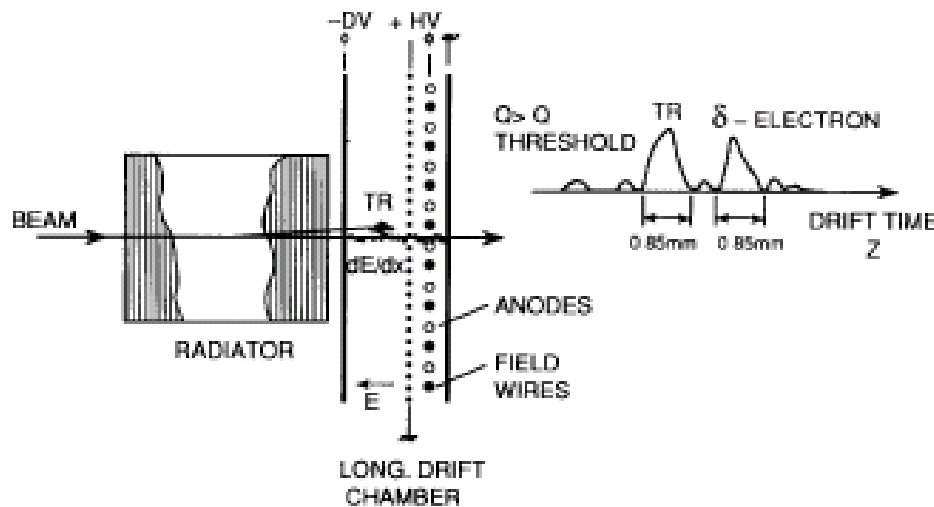

Drift space = 10 mm,  
Anode space = 6 mm  
Drift time =  $0.5 \rightarrow 1 \mu\text{s}$   
May use FADC or  
discriminators

# TRD Example 2: ATLAS TRT

## TRT straw wall design

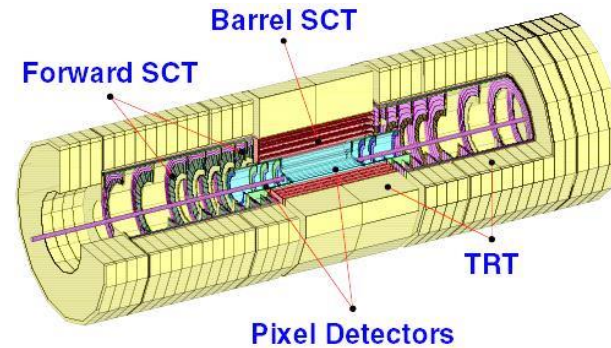
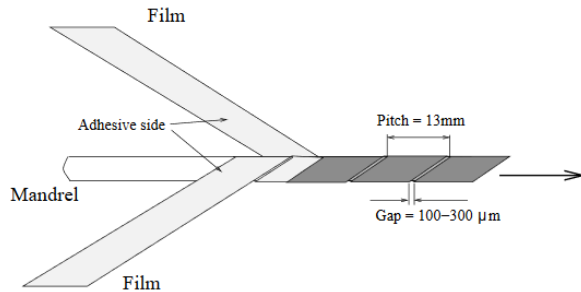

## Barrel and endcap TRT

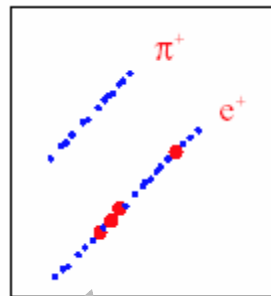
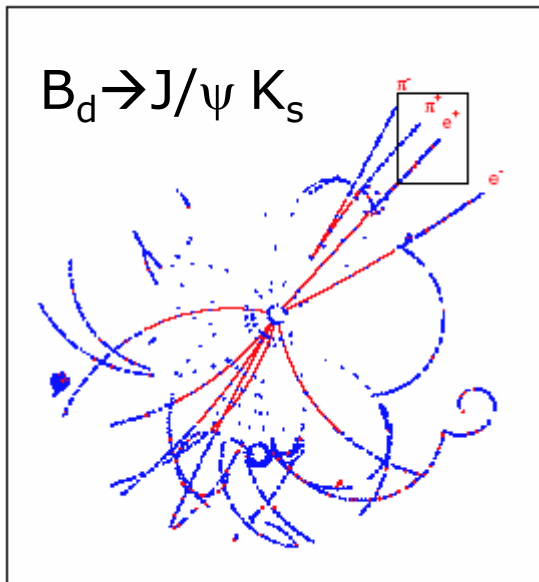

Blue dots: ionizing hits  
Red dots : TR hits

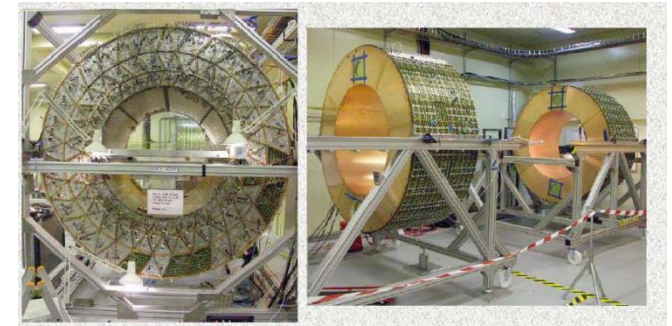

*In an average event, energy deposit from:  
Ionization loss of charged particles  $\sim 2.5$  keV  
TR photon  $> 5$  keV.  
(Photon emission spectrum peaks at 10-30keV)*

# Cherenkov radiation

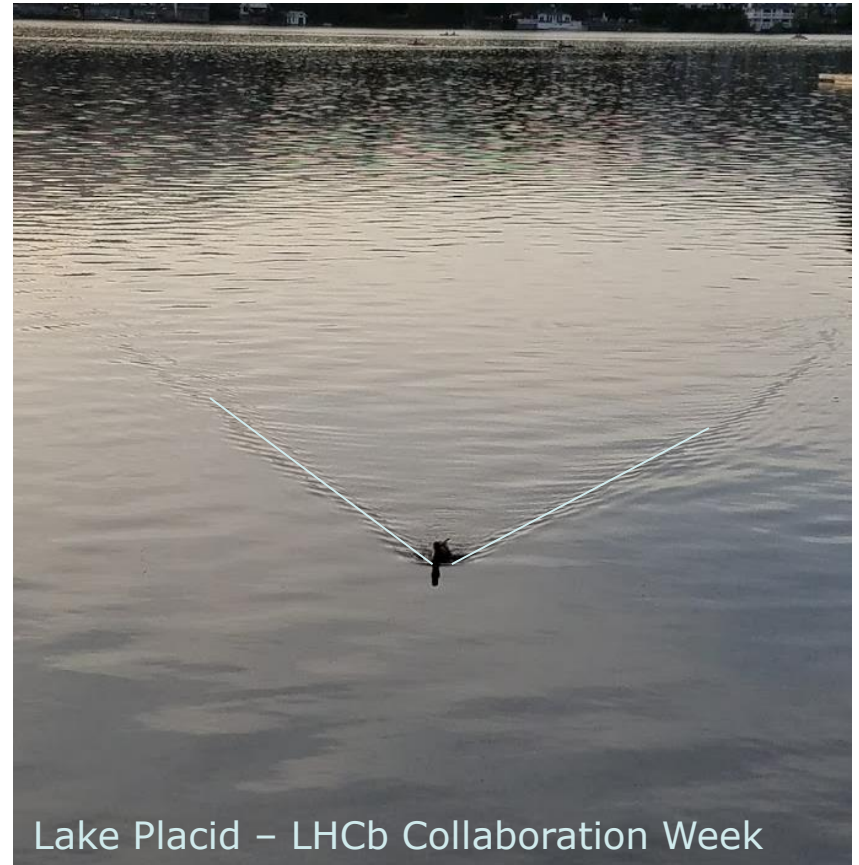
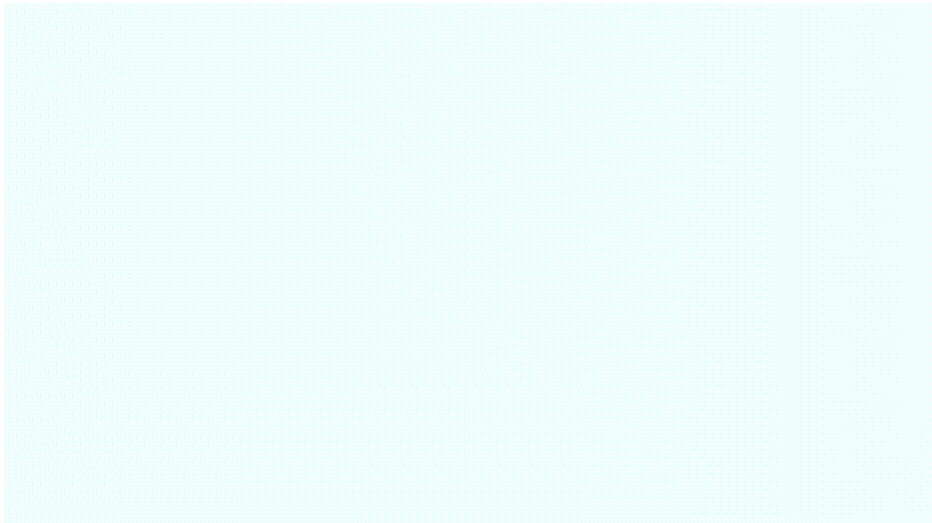

Lake Placid – LHCb Collaboration Week

# Basics of Cherenkov radiation

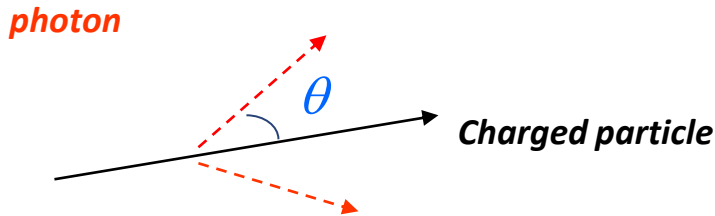

$$\cos(\theta) = \frac{1}{n(\lambda)\beta}$$

$$n(E_{ph}) = c/c_M \text{ Refractive index}$$

$$\beta = v/c = P/E = P/\sqrt{P^2 + m^2} = \frac{1}{\sqrt{1 + (m/p)^2}}$$

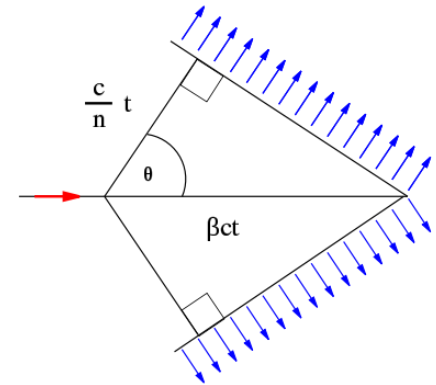

$\beta$  = velocity of the charged particle in units of speed of light (c) vacuum

P, E, m = momentum, energy, mass of the charged particle

$c_M$  = speed of light in the medium (phase velocity)

$E_{ph}$  = photon energy

$\lambda$  = Photon wavelength

Theory of Cherenkov Radiation: Classical Electrodynamics by J. D. Jackson (Section 13.5)

# Refractive index

## Glass

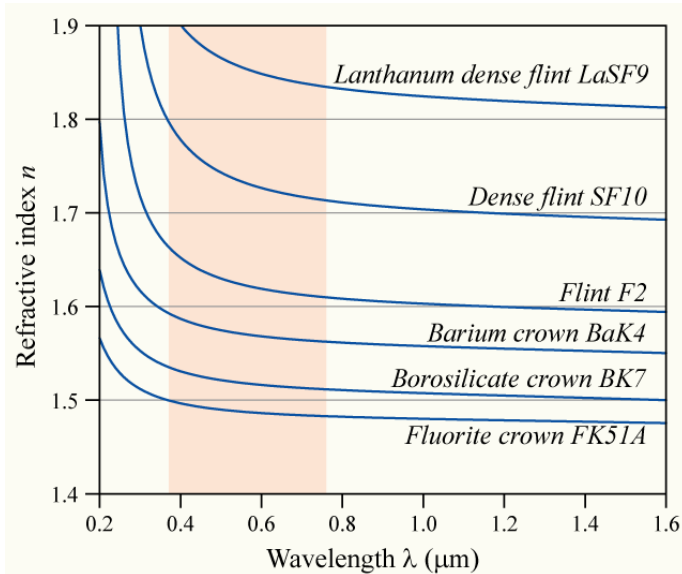

## Air

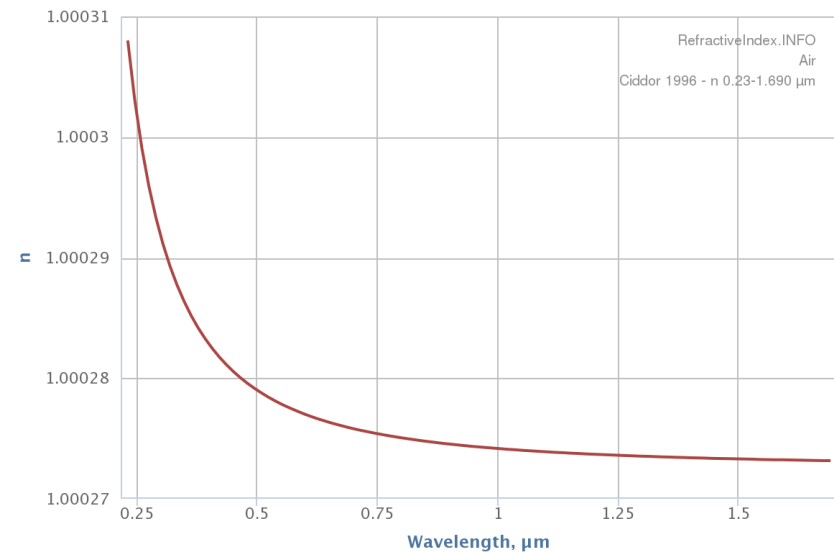

- Dependence of the refractive index on photon frequency means the Cherenkov angle is not constant
- The spread of angles is referred to as **Chromatic Error**



# Number of photons

Number of emitted photons:  $\frac{\partial^2 N}{\partial x \partial \lambda} = 2\pi a \left(1 - \frac{1}{\beta^2 n^2}\right) \frac{1}{\lambda^2}$

Between two wavelengths:  $\frac{\partial N}{\partial x} = 2\pi a \left(1 - \frac{1}{\beta^2 n^2}\right) \left(\frac{1}{\lambda_L} - \frac{1}{\lambda_H}\right)$

The number of photons increases with energy

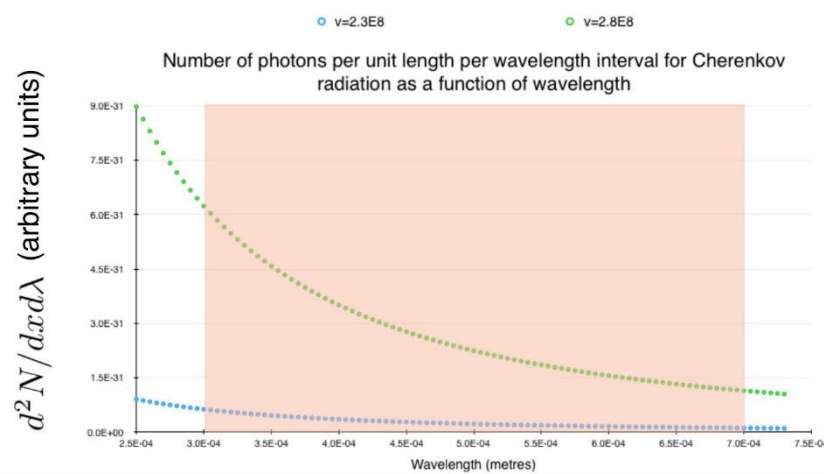

Using frequency instead of wavelength

$$\frac{dE}{dx} = \frac{q^2}{4\pi} \int_{v > \frac{c}{n(\omega)}} \mu(\omega) \omega \left(1 - \frac{c^2}{v^2 n^2(\omega)}\right) d\omega$$

Typical example: Charged particle with momentum of few GeV/c or more emitting Cherenkov photons with few eV of energy





# Detected photons

$$\frac{\partial N}{\partial x} = 2\pi a \left(1 - \frac{1}{\beta^2 n^2}\right) \left(\frac{1}{\lambda_L} - \frac{1}{\lambda_H}\right) \quad \text{For } \lambda_L=400 \text{ nm and } \lambda_H=700 \text{ nm}$$

$$\frac{N}{L} = 490 \sin^2 \theta$$

If the photons are reflected by a mirror with reflectivity  $R(\lambda)$ , and detected by a photon detector with quantum efficiency  $QE(\lambda)$  through a window with transmission  $T(\lambda)$

$$N = 490 L R Q T \sin^2 \theta$$

$$= N_0 L \sin^2 \theta \quad \text{And if we assume the mean angle } \theta_c$$

$$N = N_0 L \sin^2 \theta_c$$

$N_0$  is a figure of merit for a Cherenkov detector; e.g.  $N_0=200/\text{cm}$  is a good value



# A variety of Cherenkov detectors

- Detector design:
  - Threshold Counters
  - Imaging detectors
    - Differential Cherenkov detectors
    - Ring Imaging Cherenkov detectors (RICH)
    - Detector for Internally Reflected light (DIRC)
- Types of photon detectors:
  - Gas based
  - Vacuum
  - Solid state
- Applications:
  - Accelerator HEP detectors
  - Astroparticle Physics detectors
  - Neutrino detectors



# Threshold Cherenkov Counters

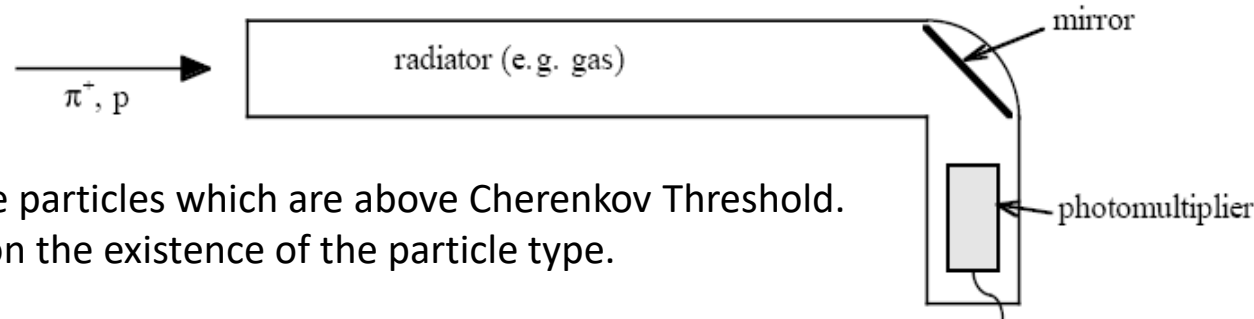

- Signal produced from only those particles which are above Cherenkov Threshold.  
Basic version: Yes/No decision on the existence of the particle type.
- One counts the number of photoelectrons detected.
- Improved version: Use the number of observed photoelectrons or a calibrated pulse height to discriminate between particle types.
- For typical detectors:  $N_o = 90 \text{ cm}^{-1}$ ,

$$N_{\text{ph}} \text{ per unit length of the radiator} = N_o * (m_1^2 - m_2^2) / (p^2 + m_1^2)$$

At  $p = 1 \text{ GeV}/c$ ,  $N_{\text{ph}}$  per unit length = 16 /cm for Pions and 0 for Kaons.

At  $p = 5 \text{ GeV}/c$ ,  $N_{\text{ph}}$  per unit length = 0.8 /cm for Pions and 0 for Kaons.

- $\Delta \beta / \beta = \tan^2 \theta / (2 * \text{sqrt}(N_{\text{ph}}))$

# Differential Cherenkov Detectors

With Solid (quartz) radiator

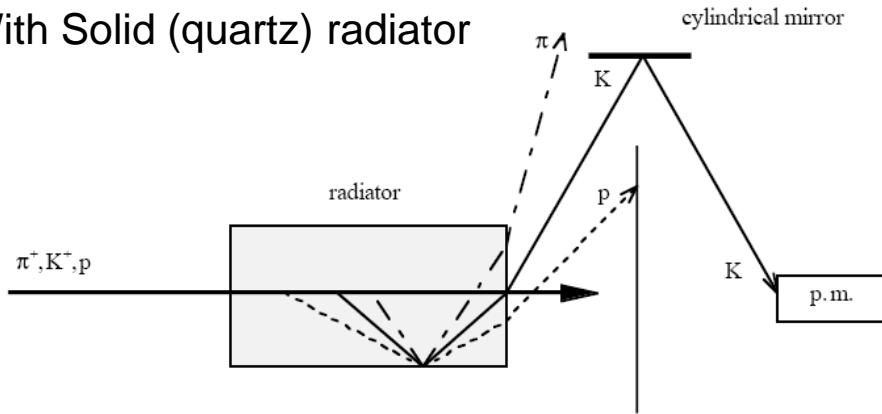

- Very small acceptance in  $\beta$  and direction of the charged particle. (Narrow range in velocity and direction intervals).
- Mostly used for identifying particles in the beam lines.

$$\Delta \beta / \beta = (m_1^2 - m_2^2) / 2 p^2 = \tan \theta \quad \Delta \theta$$

$m_1, m_2$  (particle masses)  $\ll p$  (momentum)

- $\Delta \beta / \beta$  from 0.011 to  $4 \cdot 10^{-6}$  achieved.

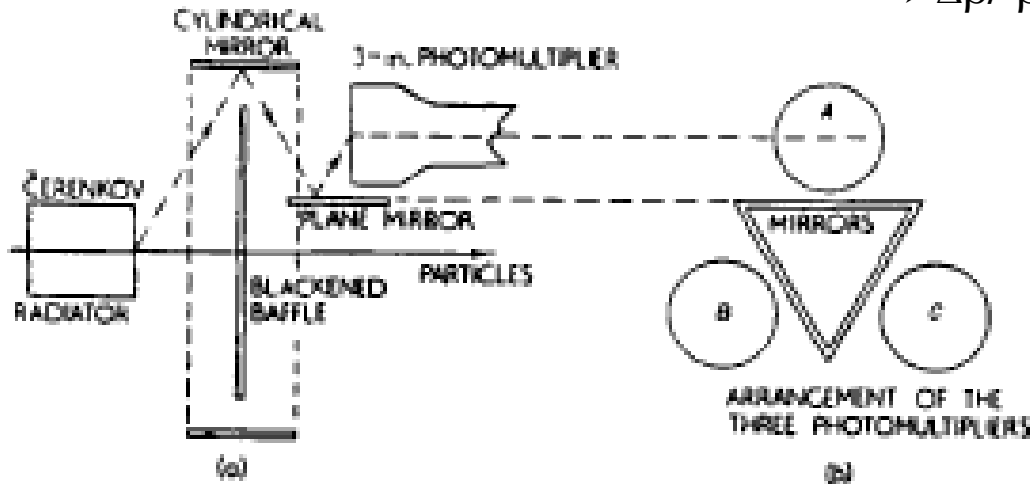

- Discovery of anti-proton in 1955 by Chamberlain, Segre et. al. at Berkeley.

Fig. 2. The differential Cherenkov counter used in the anti-proton discovery experiment: (a) side view; (b) end view.

- Nobel Prize in 1959

# Threshold Counters

## BELLE: Threshold Cherenkov Detector

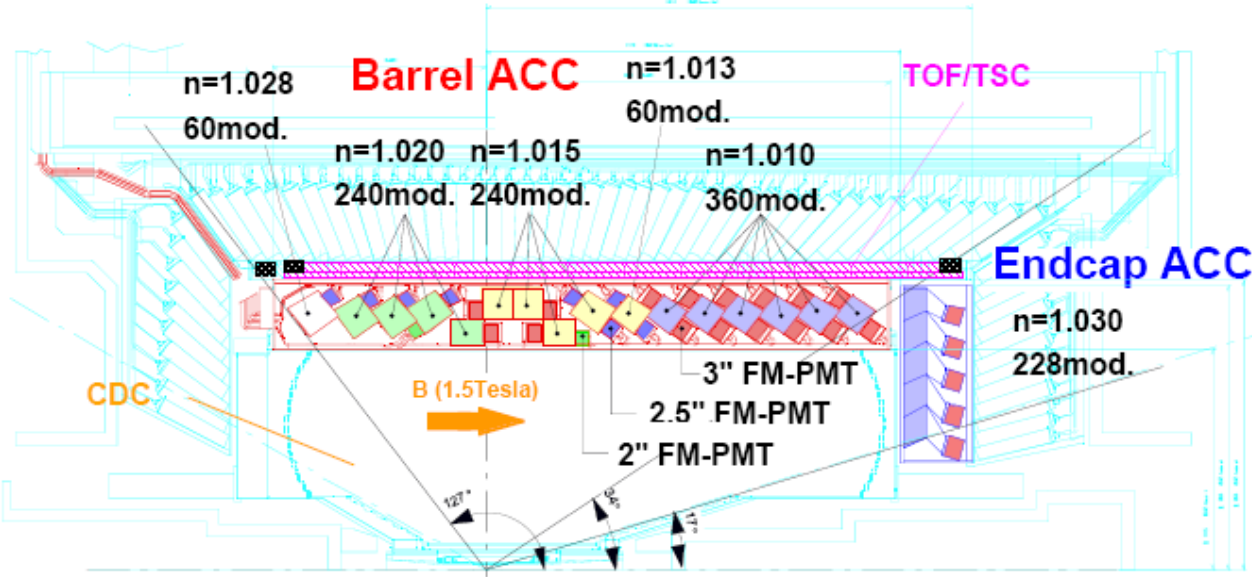

- Five aerogel tiles inside an aluminum box lined with a white reflector (Goretex reflector)
- Performance from test-beam

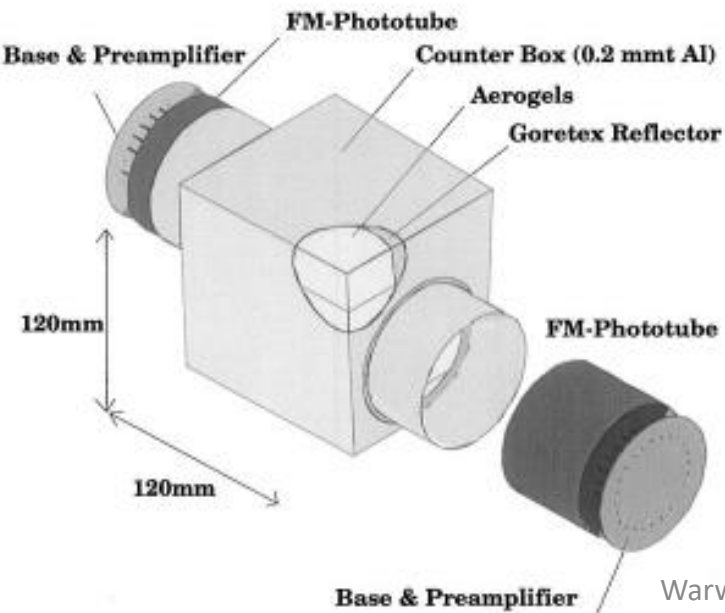

- Approx . 20 photoelectrons per Pion detected at 3.5 GeV/c
- More than  $3\sigma$  separation

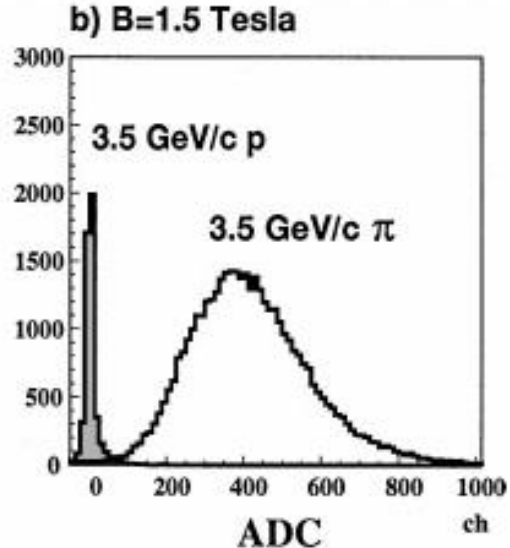

p below and  $\pi$  above Threshold

# RICH Detectors

Proximity focusing geometry

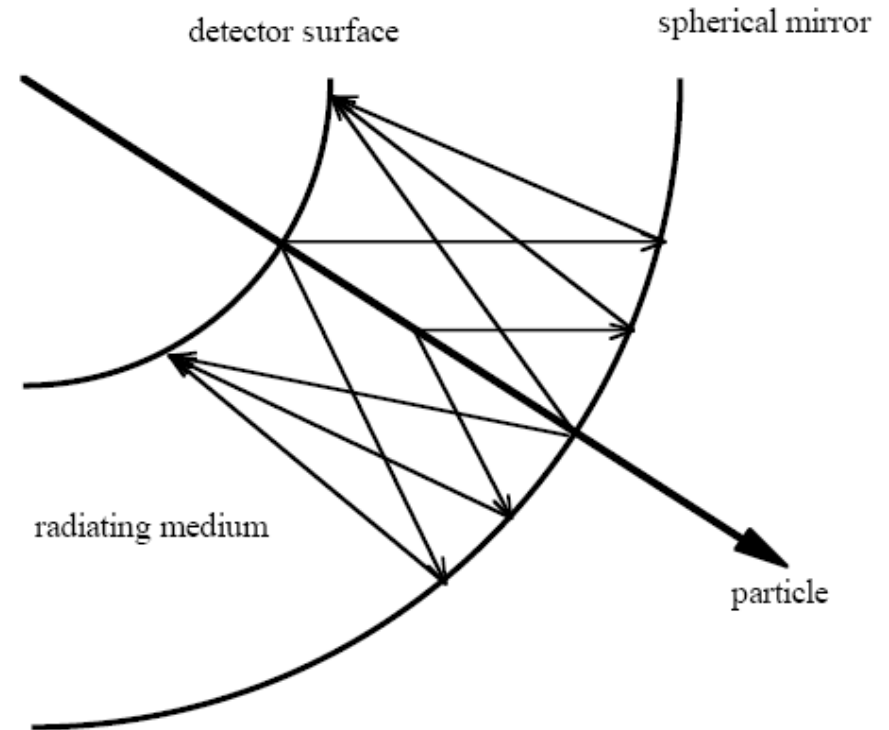
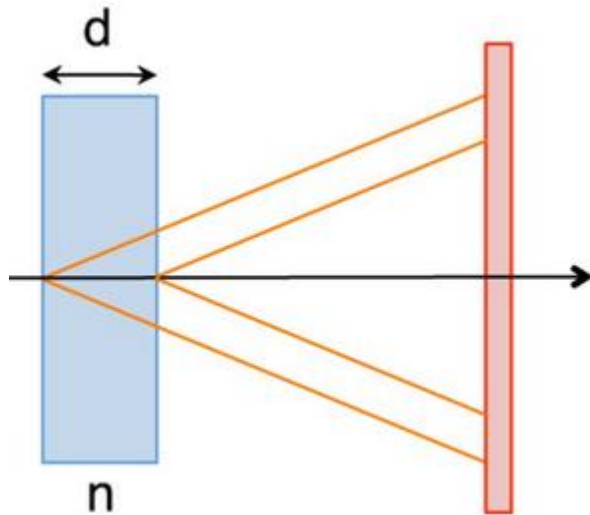

- Measures both the Cherenkov angle and the number of photoelectrons detected.
- Can be used over particle identification over large surfaces.
- Requires photodetectors with single photon identification capability.



# Refractive index range

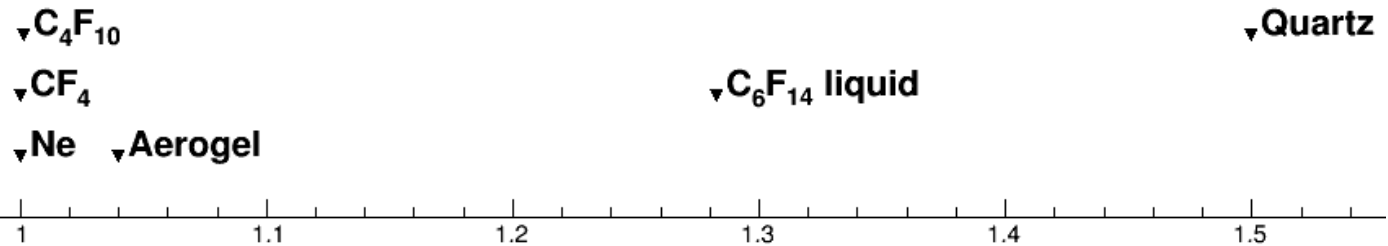

Momentum

# RICH performance

$$N_\sigma \approx \frac{|m_1^2 - m_2^2|}{2P^2 \sigma[\theta_c(\text{tot})] \sqrt{n^2 - 1}}$$

For particles well above threshold

B. N. Ratcliff, NIMA 502 (2003) 211-221

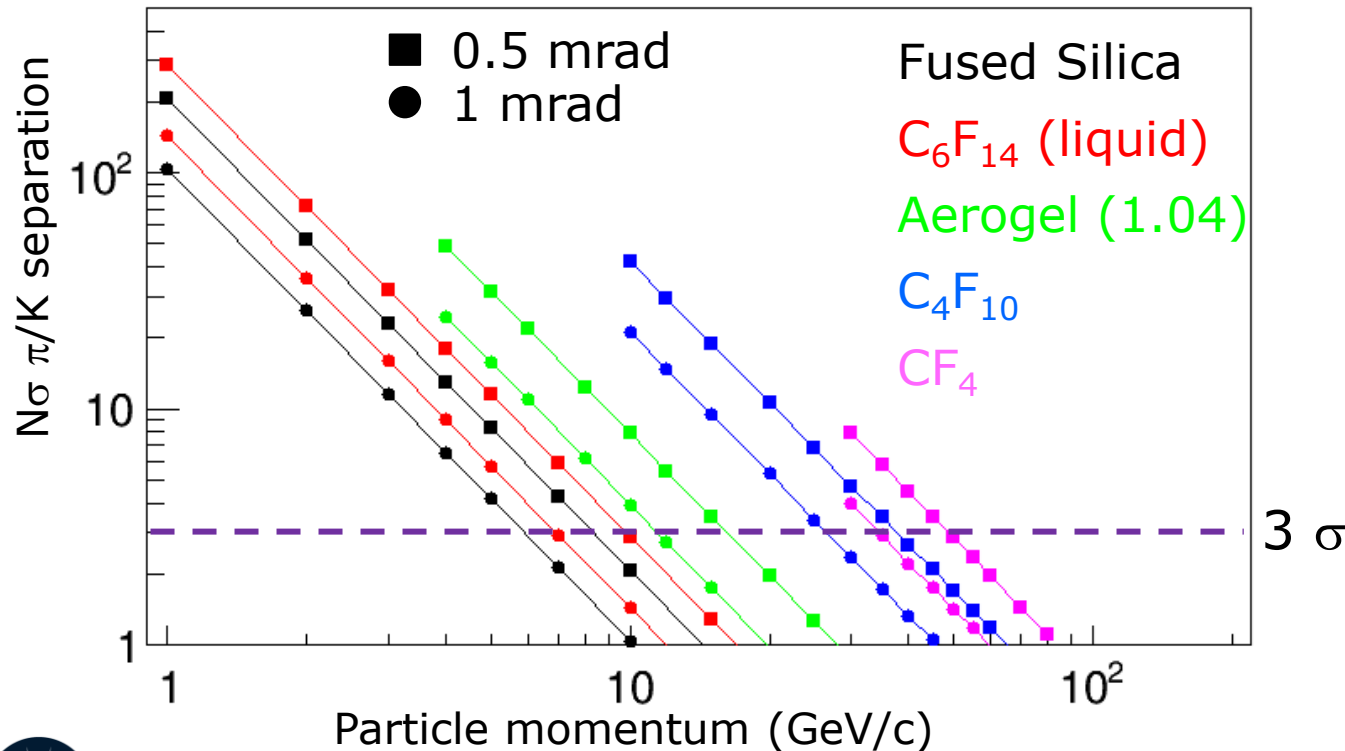



# Detection of optical photons

## ■ Photocathode:

- A surface engineered to convert optical photons to electrons using the photo-electric effect
- Requires the energy of the photon to be higher than the “work function”
- Also possible in gas form
- Quantum Efficiency (QE): fraction of photons converted to electrons

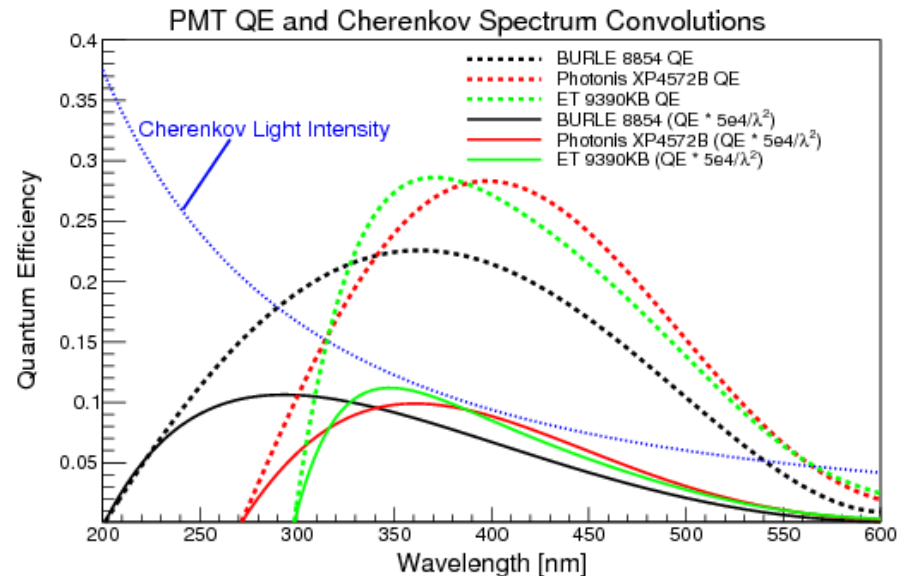
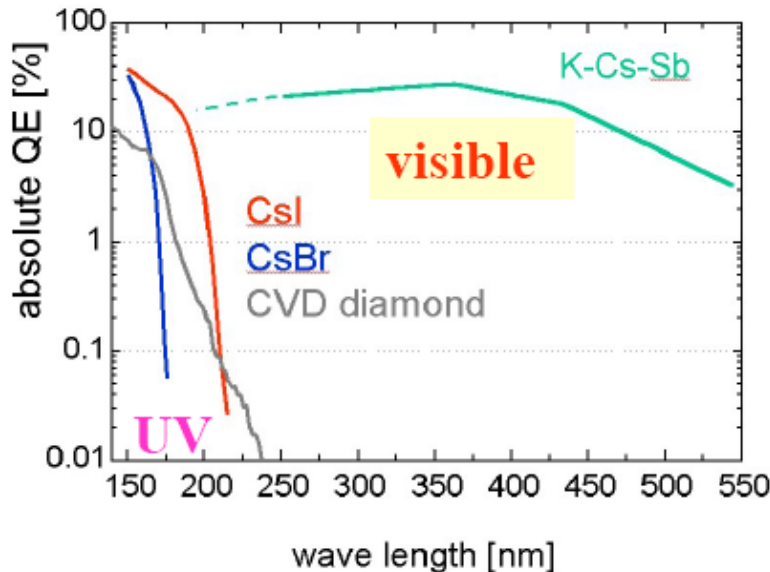

# Latest photocathodes

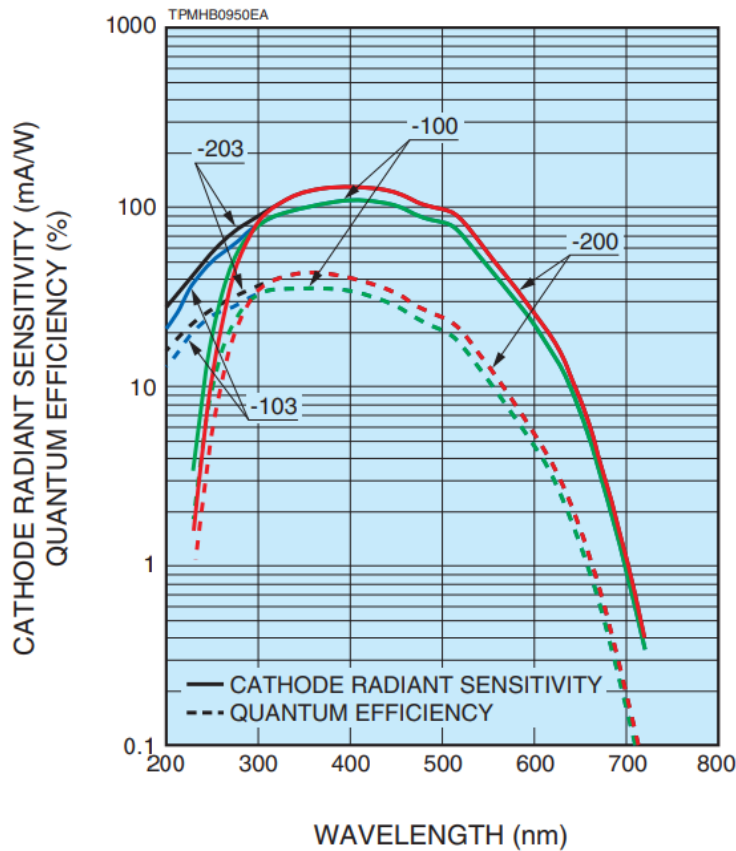

Type No.	Spectral response		Photo-cathode material <sup>(A)</sup>	Characteristics <sup>(D)</sup>
	Range (nm)	Peak wavelength (nm)		Quantum efficiency Typ. (%)
R11265U-100-M4	300 to 650	400	SBA	35
R11265U-200-M4	300 to 650	400	UBA	43
R11265U-103-M4	185 to 650	400	SBA	35
R11265U-203-M4	185 to 650	400	UBA	43
H13226A-100	300 to 650	400	SBA	35
H13226A-200	300 to 650	400	UBA	43
H13226A-103	185 to 650	400	SBA	35
H13226A-203	185 to 650	400	UBA	43



# Detection of photo-electrons

- Gas based detectors
  - Proportional counters
  - MWPC
  - GEM
  - Other kind of micro-pattern detector
- Vacuum:
  - Photomultipliers
  - Microchannel plates
  - Hybrid photon detectors (HPD)
- Solid state
  - Avalanche photo-diodes (APD)
  - SiPMs

# Gas based detectors

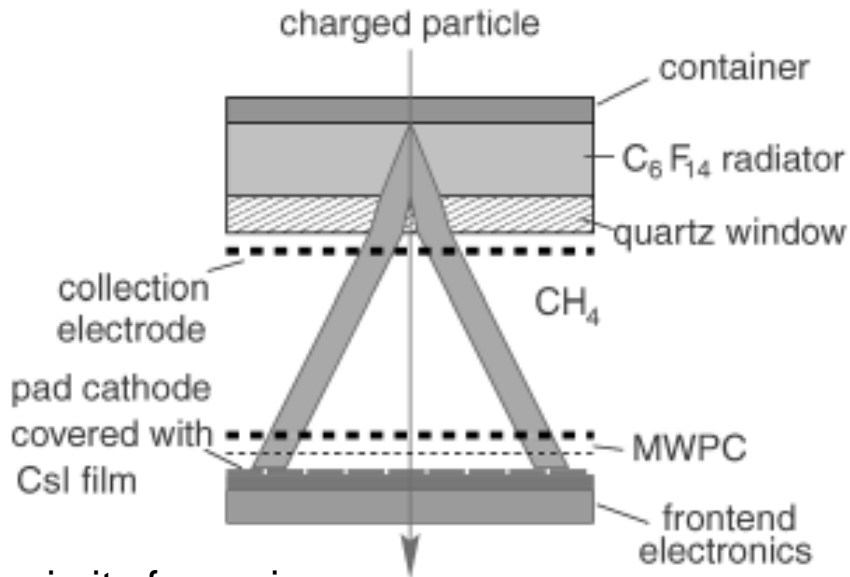

Proximity focussing

➤ Used in ALICE experiment at CERN

- Thickness of :
- radiator = 10mm
  - quartz window= 5mm
  - MWPC gaps= 2 mm
  - Wire cathode pitch=2 mm
  - Anode pitch= 4 mm
  - anode diameter= 20 micron
  - pad size = 8\*8 mm<sup>2</sup>

➤ Total detector area: 12 m<sup>2</sup>

➤ Open geometry: using MWPC

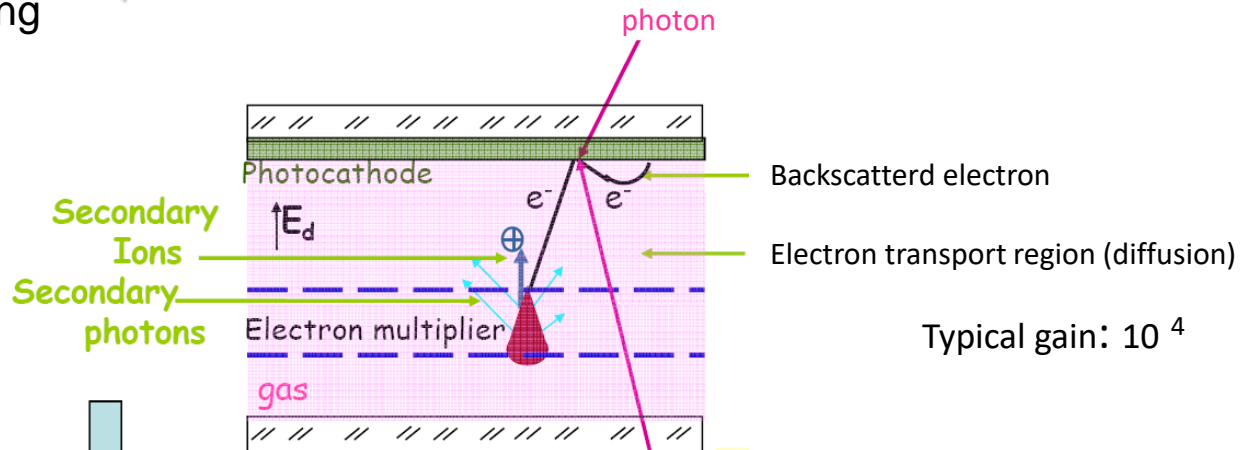

Typical gain: 10<sup>4</sup>

cause feedback: leading to loss of original signal info



# GEM based gas detectors

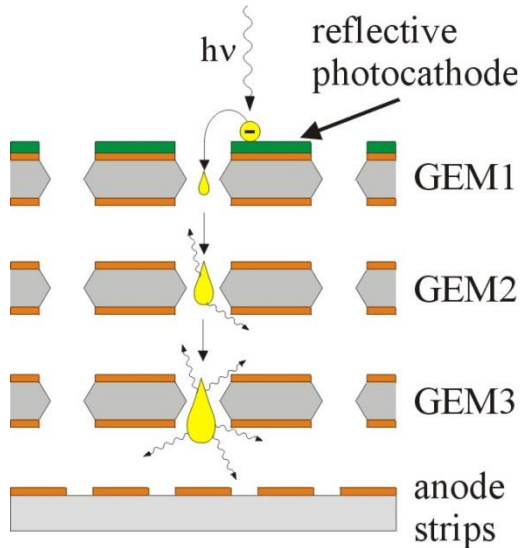

GEM: Gas Electron Multiplier

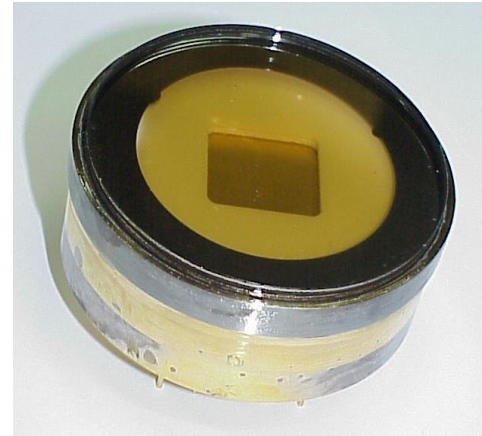

GEM with semi-transparent Photocathode (K-Cs-Sb)

- Photon and ion feed back reduced.
- Gated operation to reduce noise. (no readout outside a 'time window of signal')
- For now only closed geometry ( in sealed tubes): Reduced fraction of useful area for photon detection (Active Area Fraction) compared to open geometry.

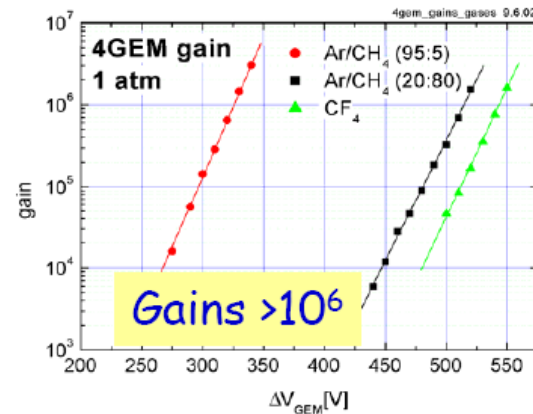

# Pixel-HPD description

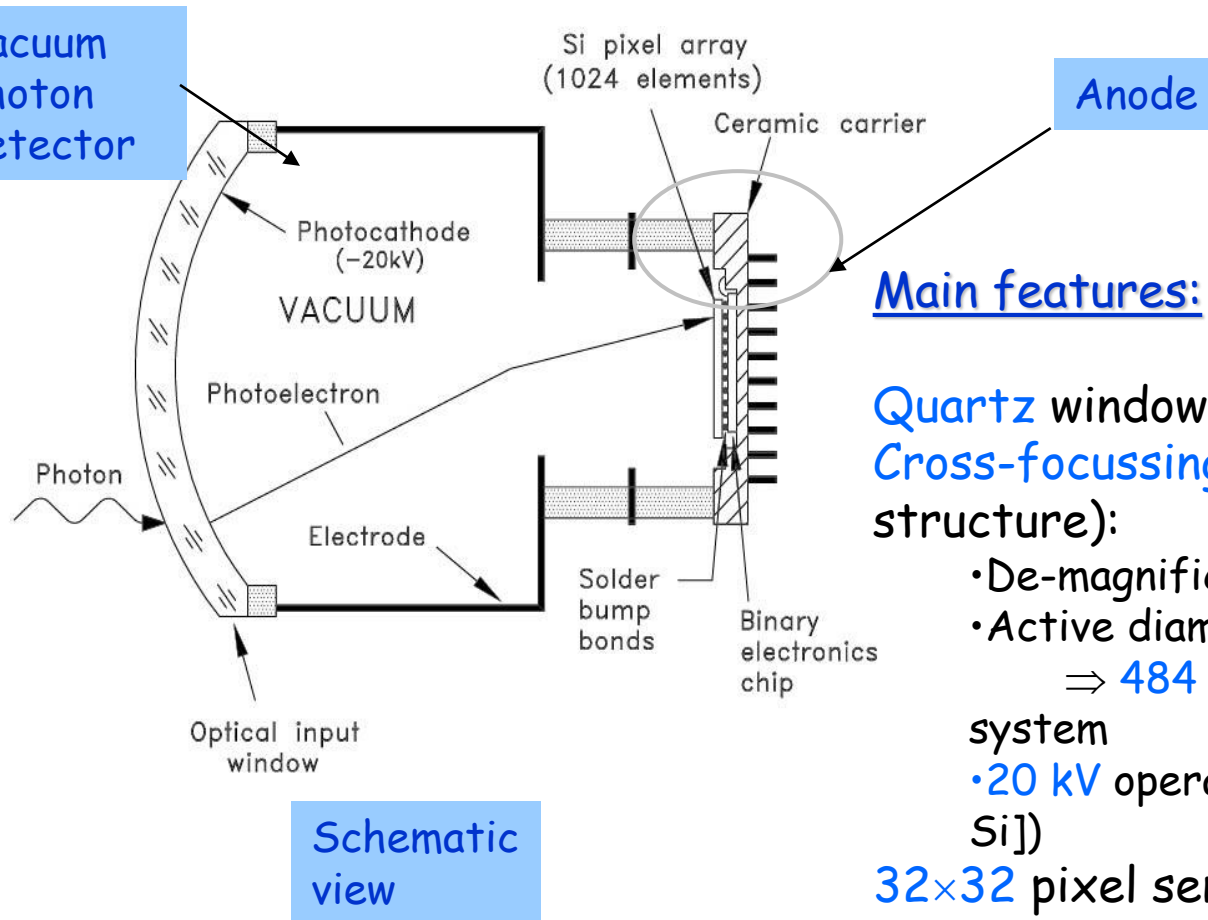

## Main features:

Quartz window with thin S20 pK  
Cross-focussing optics (tetrode structure):

- De-magnification by  $\sim 5$
- Active diameter  $75\text{mm}$   
⇒ 484 tubes for overall RICH system
- $20\text{ kV}$  operating voltage ( $\sim 5000\text{ e}^-$  [eq. Si])

$32 \times 32$  pixel sensor array ( $500\mu\text{m} \times 500\mu\text{m}$  each)

Encapsulated binary electronics readout chip



# Silicon Photo-Multiplier

- Primary building block, GM-APD.

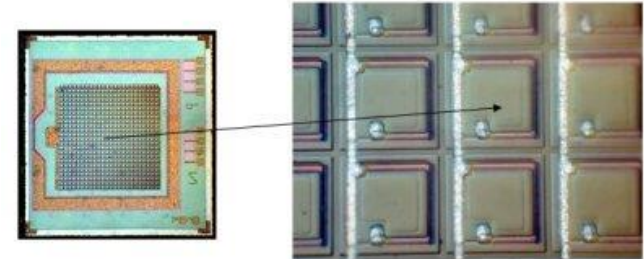
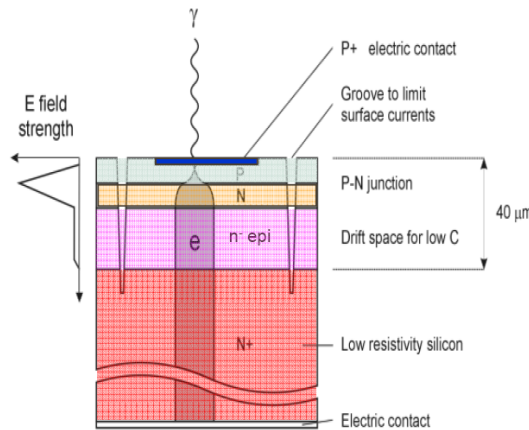
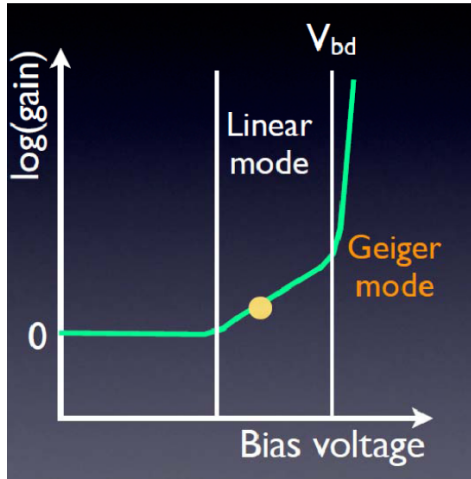

- Photon Detection Efficiency (PDE) for SiPM is better than that of ordinary PMT.
- Time resolution =  $\sim 100$  ps.
- Works in magnetic field
- Gain =  $\sim 10^6$
- Reducing noise levels for single photon detection is still an issue especially after irradiation

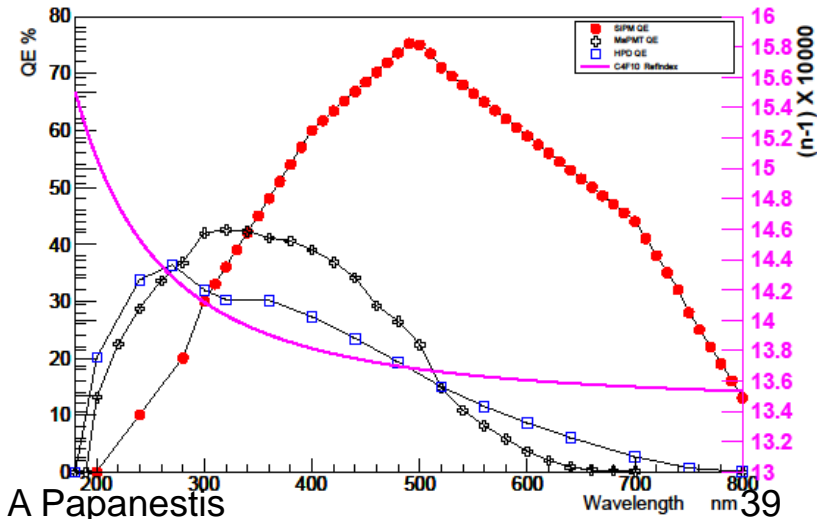



# SiPM spectrum

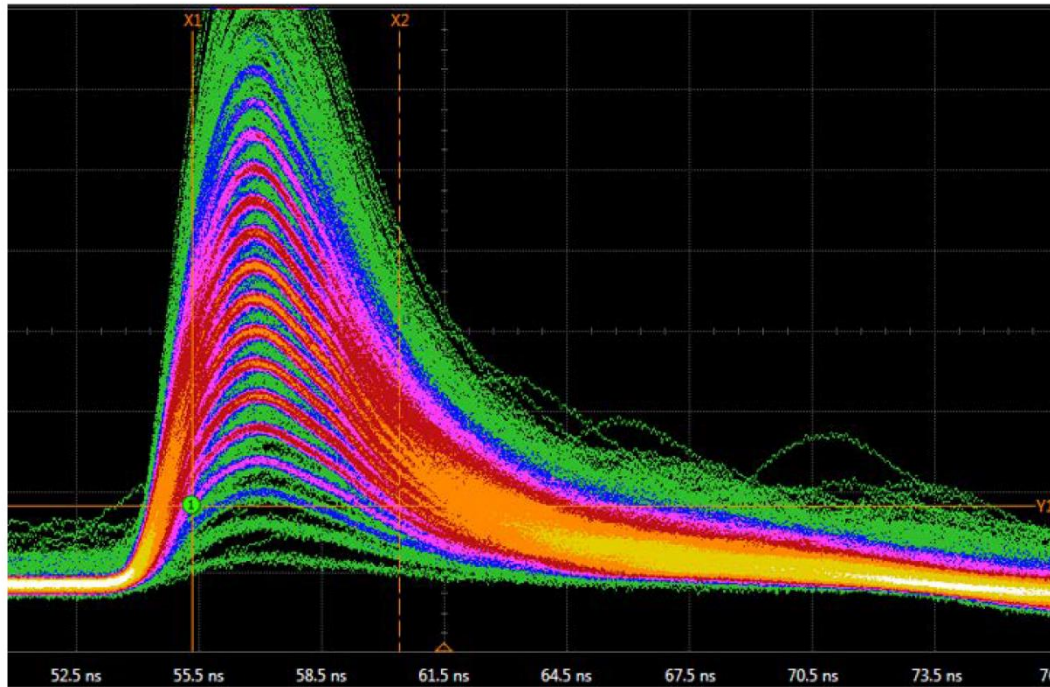

(a)

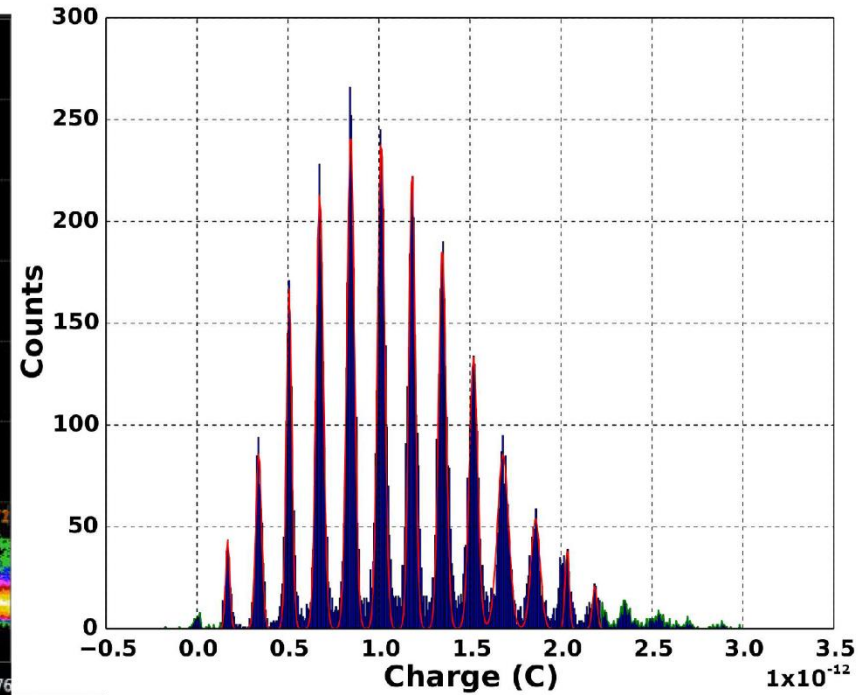

(b)

Hamamatsu SiPM S13360–3075CS

<https://doi.org/10.3390/electronics10080961>



# Micro Channel Plate (MCP) Photon Detectors

Proximity focused MCP tube with 55um pixel readout

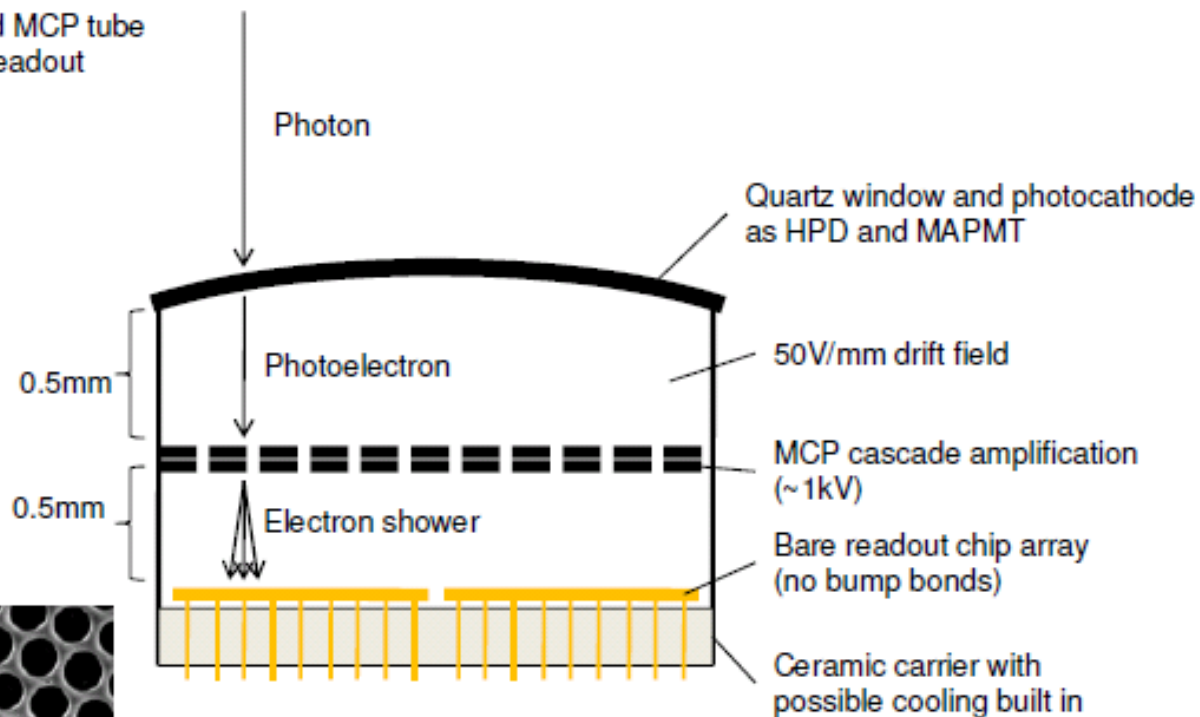

Tuning the lower drift field allows the electron shower profile to be well controlled

Cascade amplification similar in principle to a PMT

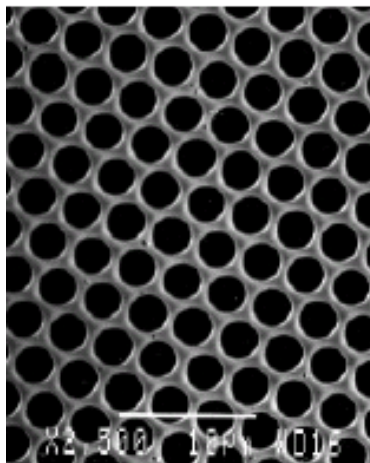

10um pores in an MCP

## Micro Channel Plates (MCP )

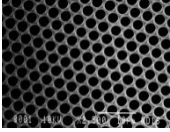

Typical Size:

- 2 mm thickness,  
51 mm X 51 mm active area.
- 10 micron pores separated by 15 microns
- Chevron: 8 degree tilt : To increase the gain and reduce ion-feed back
- Gain:  $\sim 5 * 10^5$
- Typically  $\sim 1000$  channels per MCP.

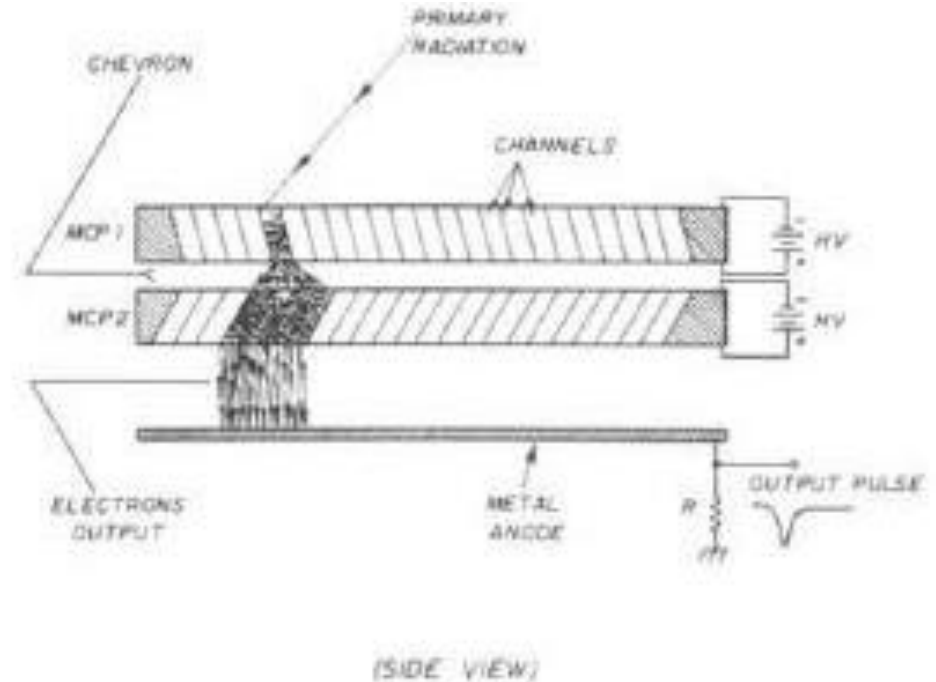

- Measure Space and time of the hits.
- Manufactured by industry ( Photonics for example).
- Resolutions: Space:  $\sim 100$  microns, Time:  $\sim 50 - 100$  psec.
- Short flight path of photoelectrons: Resistant to magnetic fields up to 0.8 Tesla.
- Can work at 40 MHz readout rate.
- Can detect single photons ( No noise from 'first dynode' as in MAPMT).
- Fast 'ageing' at large luminosity (eg: LHC) is an issue, but there are some solutions.

# LHCb Experiment

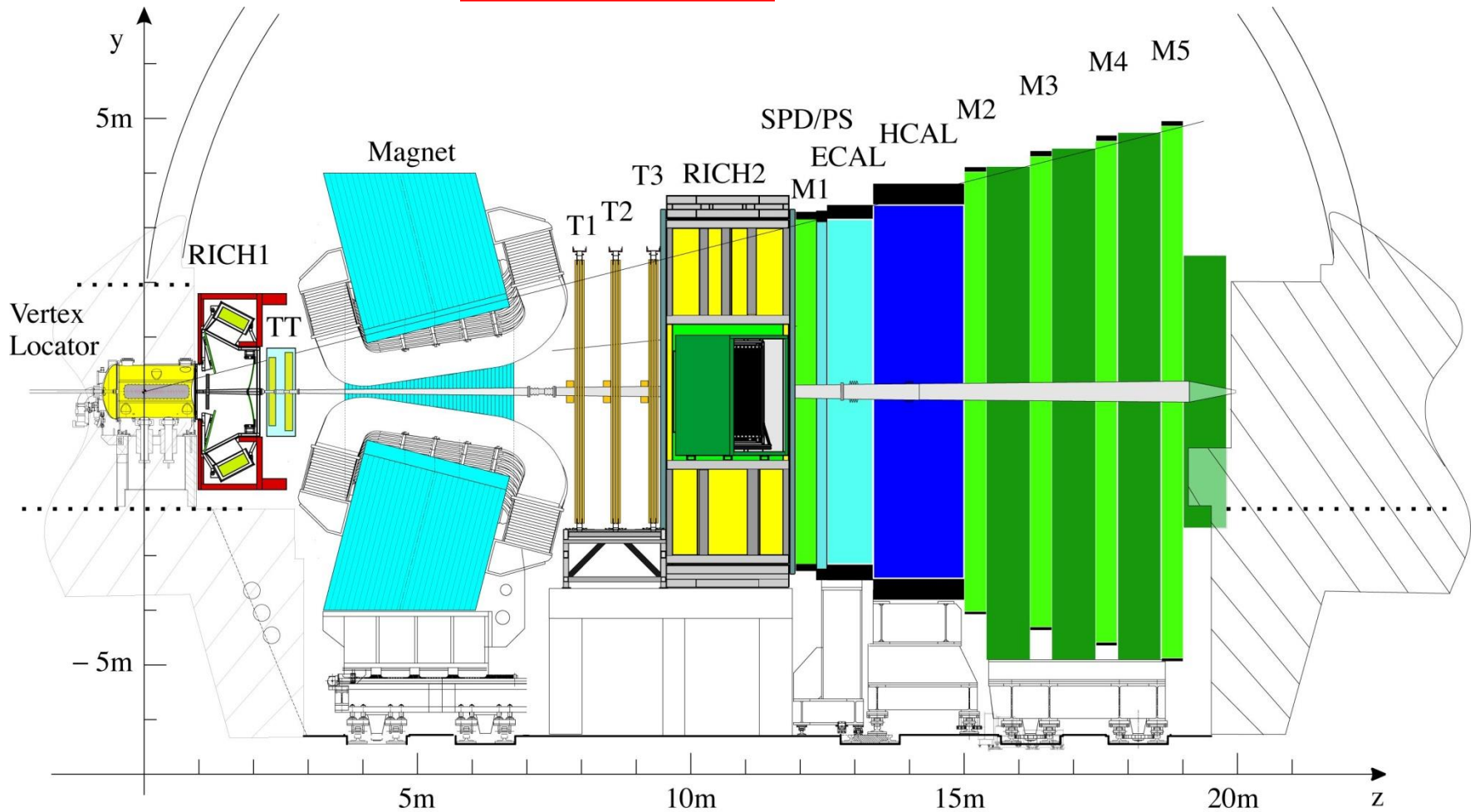

- Precision measurement of B-Decays and search for signals beyond standard model.
- Two RICH detectors covering the particle momentum range  $1 \rightarrow 100$  GeV/c using aerogel,  $C_4F_{10}$  and  $CF_4$  gas radiators.

# LHCb-RICH Specifications

RICH1: Aerogel  $2 \rightarrow 10$  GeV/c

$C_4F_{10}$   $< 70$  GeV/c

RICH2:  $CF_4$   $< 100$  GeV/c.

Aerogel  $C_4F_{10}$   $CF_4$

L 5 86 196 cm

$\theta_c^{\max}$  242 53 32 mrad

$\pi_{Th}$  0.6 2.6 4.4 GeV/c

$K_{Th}$  2.0 9.3 15.6 GeV/c

Aerogel: Rayleigh Scattering

Not used from 2015 onwards

$$T = A e^{-C t / \lambda^4}$$

Typically:  $A = 0.94$ ,  $C = 0.0059 \mu\text{m}^4/\text{cm}$

(Refractive Index-1) vs. Photon Energy

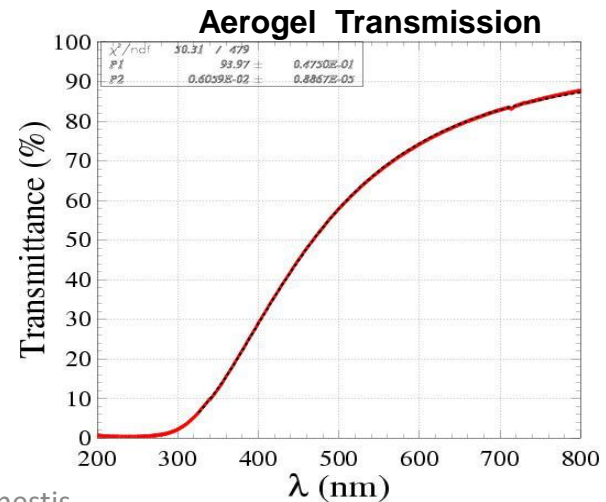
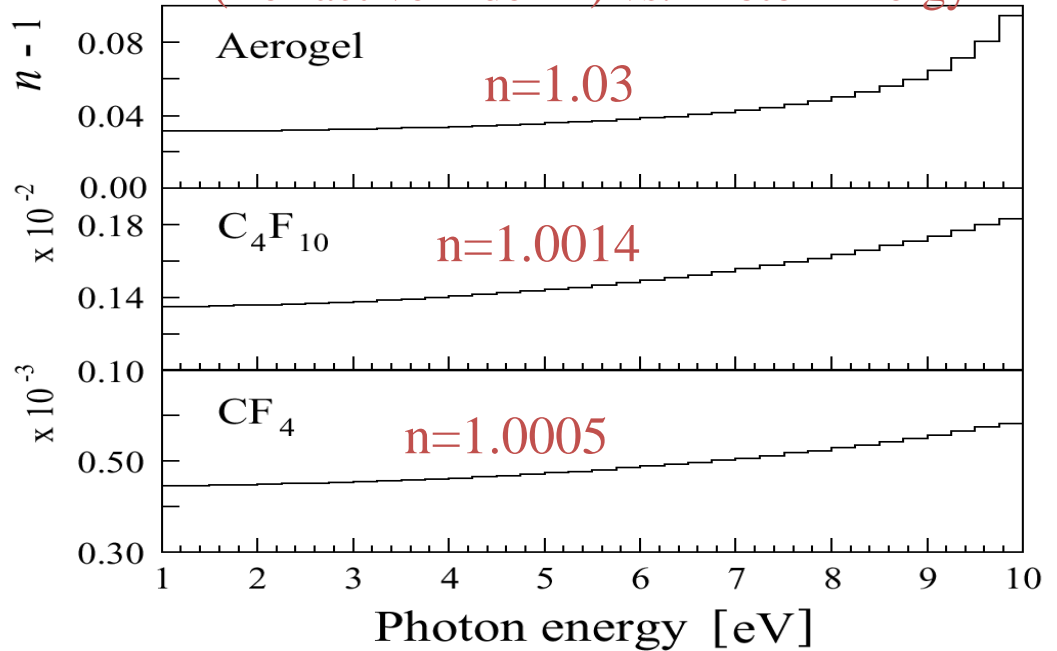

# Belle II ARICH (Endcap)

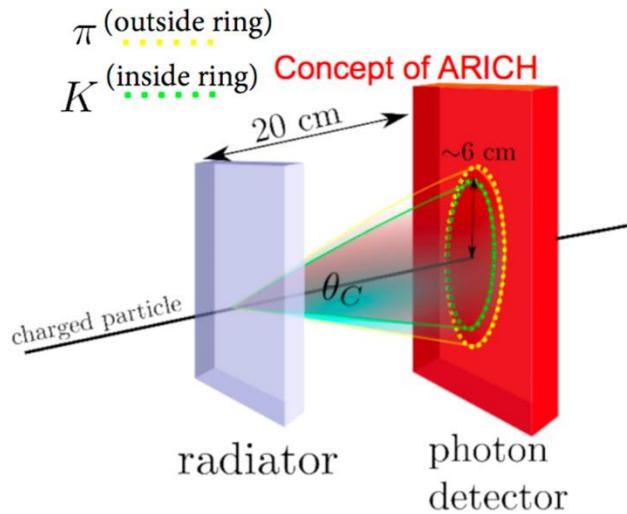

- Two tile focusing aerogel radiator
- Proximity focusing optics
- HAPD detectors
  - Bi-alkali photocathode
  - Work in magnetic field

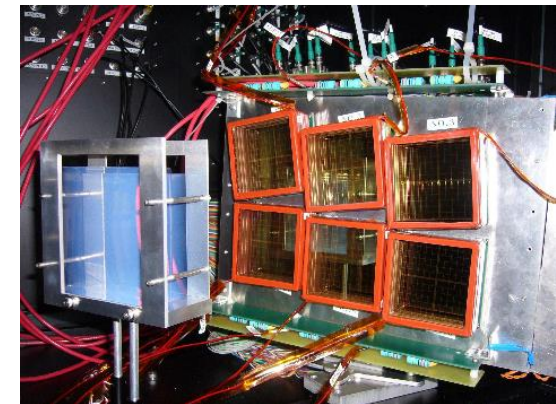
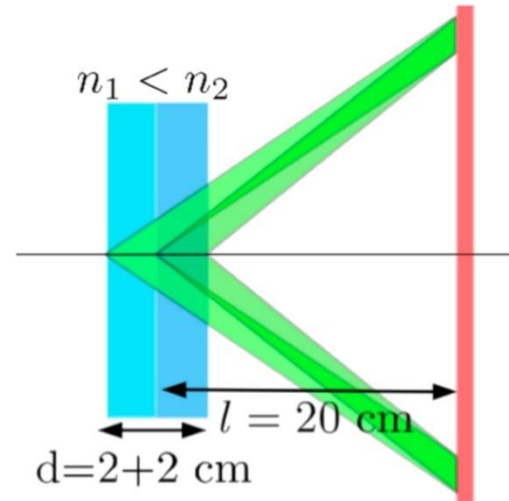
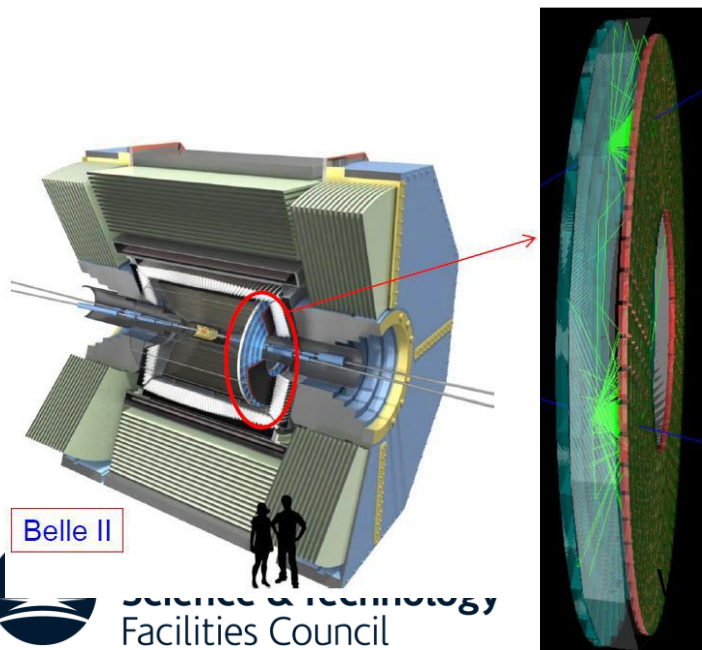



# LHCb- RICH1 SCHEMATIC

## RICH1 OPTICS

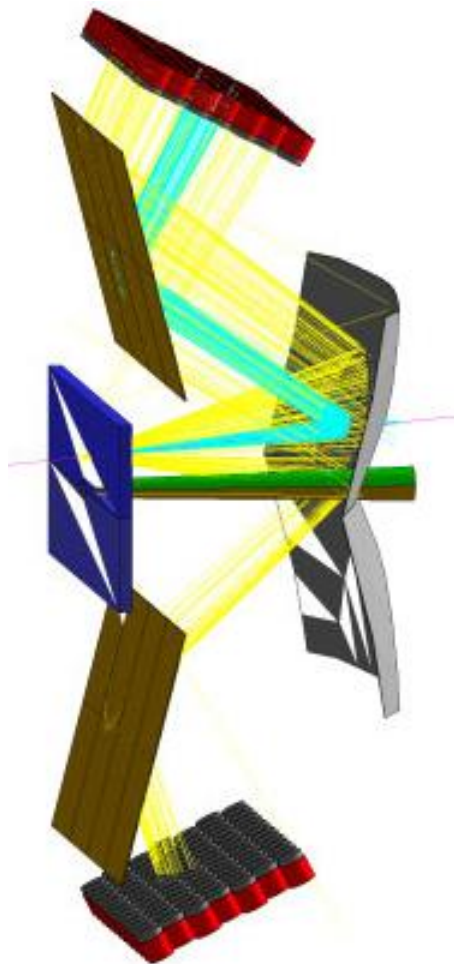

Magnetic Shield

Gas Enclosure

Beam Pipe

Spherical Mirror

Flat Mirror

Photodetectors

Readout Electronics

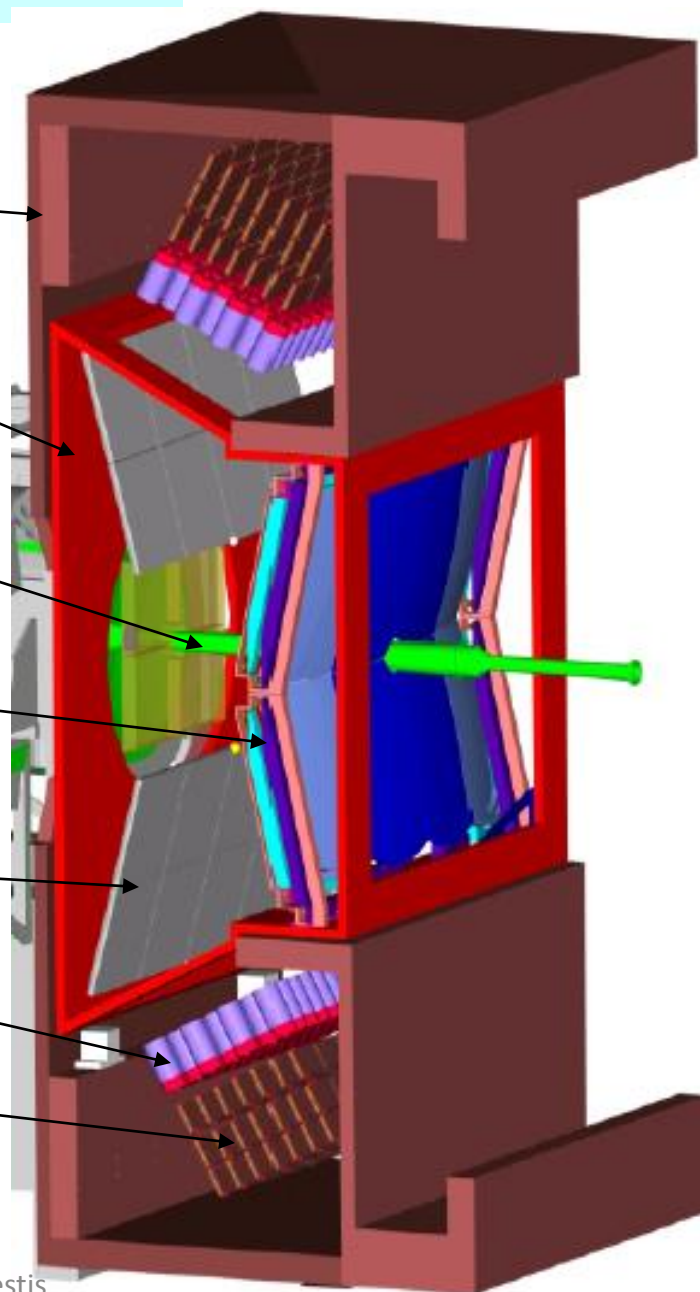

- Spherical Mirror tilted to keep photodetectors outside acceptance (tilt  $\sim 0.3$  rad)

# Performance of LHCb RICH

- From isolated Cherenkov rings from RICH1 in Real Data

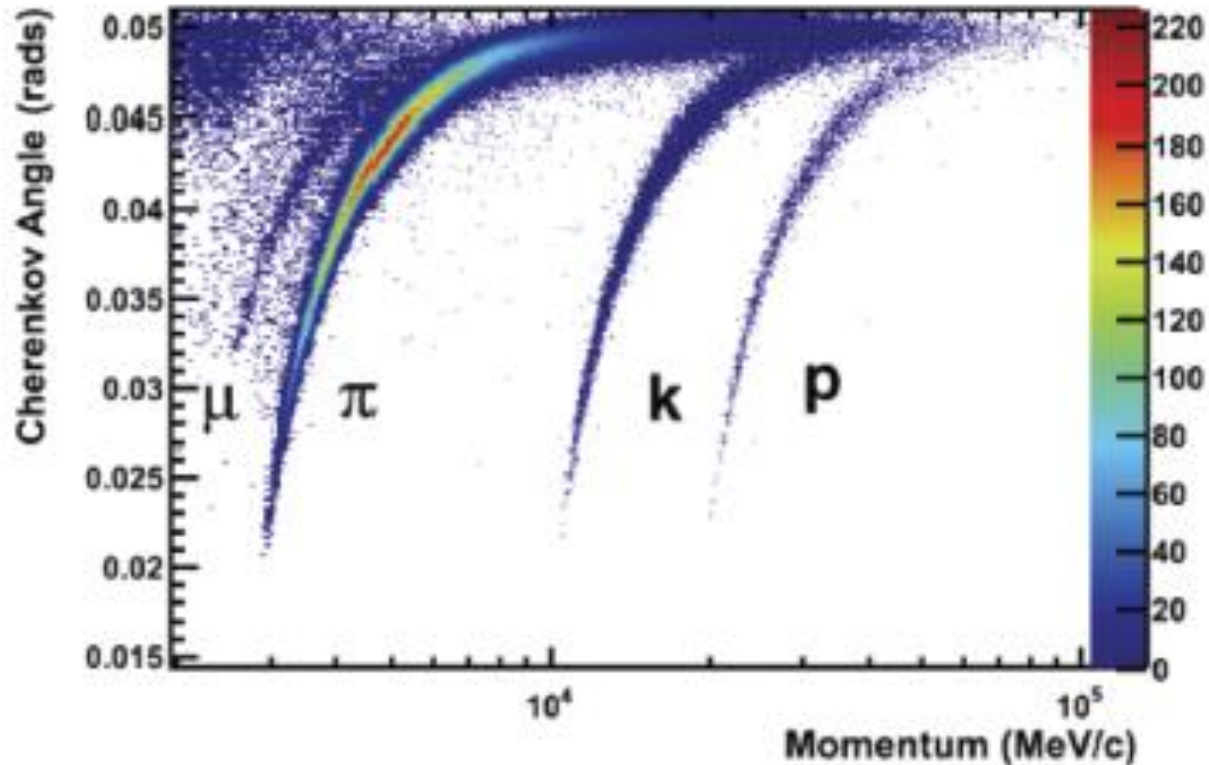

Compare with the expectations plotted in page 9.

# LHCb-RICH resolution

## Single photon resolutions

Real Data 2011:

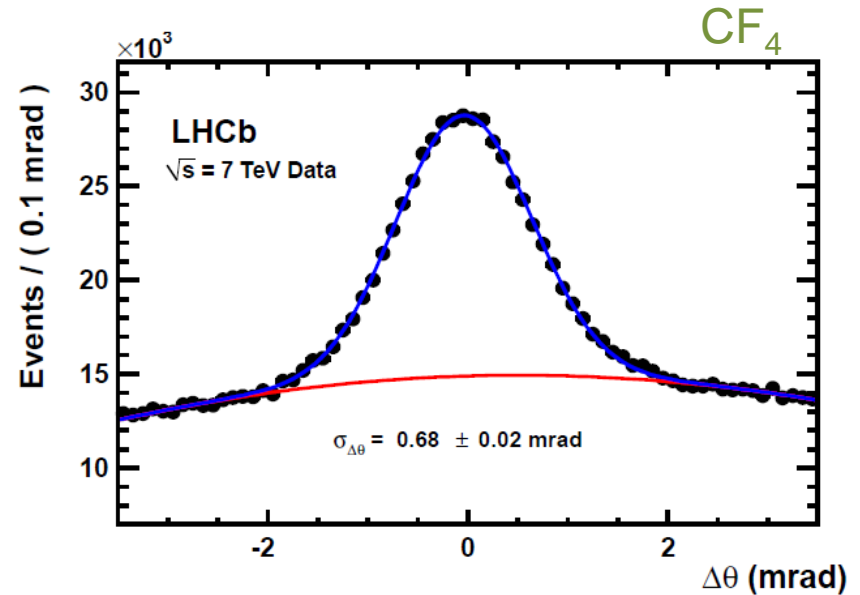
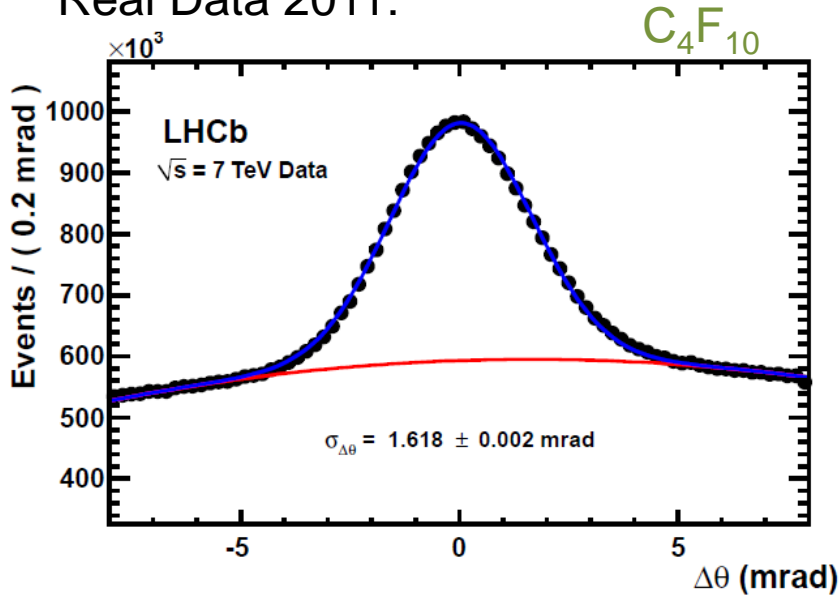

From simulation in 2011:

$$\sigma_{\Delta\theta} = 1.53 \text{ mrad}$$

From simulation in 2011:

$$\sigma_{\Delta\theta} = 0.68 \text{ mrad}$$

- Resolution components:
- Chromatic : ref. index variation
  - Emission Point: tilt of the mirror
  - Pixel size: granularity of the pixel
  - PSF: spread of photo electron direction inside HPD



# HPD photocathode position

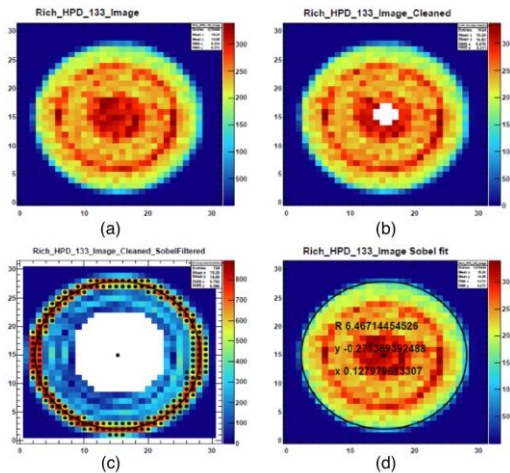

Automatic Online calibration for every run (max 1 hour)

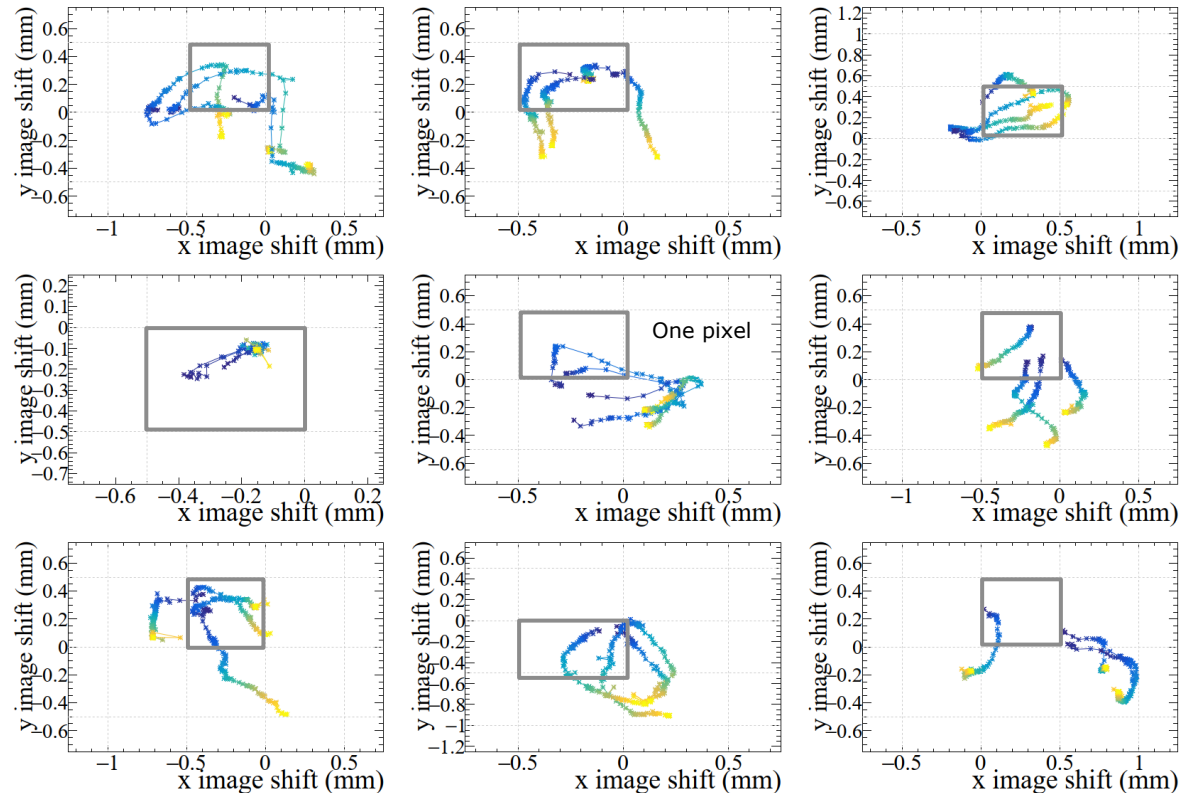

# Pattern recognition

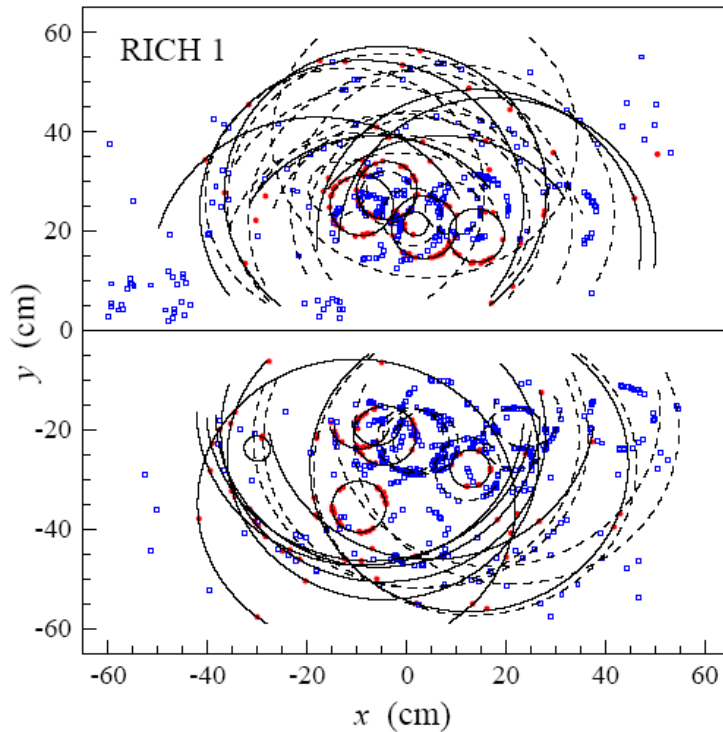

**Red:** From particles from Primary and Secondary Vertex  
**Blue:** From secondaries and background processes  
(sometimes with no reconstructed track)

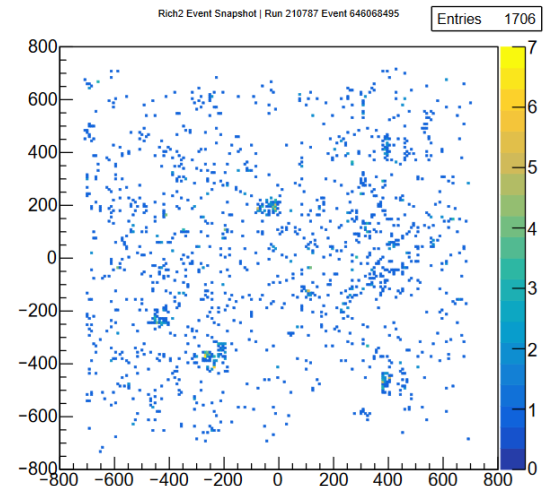
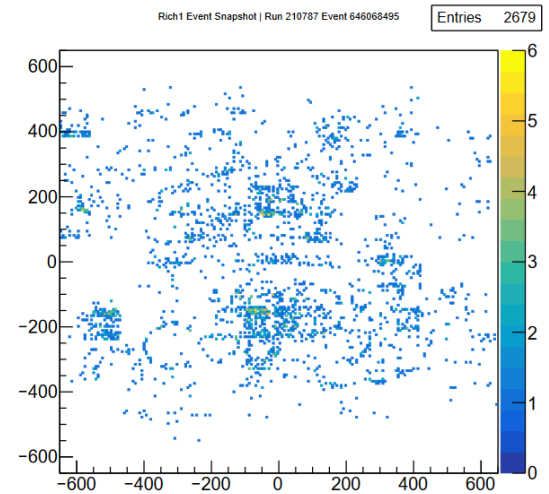

# Pattern Recognition in Accelerator based Cherenkov Detector

- Events with large number of charged tracks giving rise to several overlapping Cherenkov Rings on the Photo detector plane.  
Problem: To identify which tracks correspond to which hits and then identify the type (e,  $\pi$ , p etc.) of the particle which created the tracks.
- Hough Transform: (used by ALICE at CERN)
  - Project the particle direction on to the detector plane
  - Accumulate the distance of each hit from these projection points in case of circular rings.
  - Collect the peaks in the accumulated set and associate the corresponding hits to the tracks.
- Likelihood Method: (used by LHCb at CERN)
  - For each of the track in the event, for a given mass hypothesis, create photons and project them to the detector plane using the knowledge of the geometry of the detector and its optical properties. Repeat this for all the other tracks.
  - From this calculate the probability that a signal would be seen in each pixel of the detector from all tracks.
  - Compare this with the observed set of photoelectron signal on the pixels, by creating a likelihood.
  - Repeat all the above after changing the set of mass hypothesis of the tracks. Find the set of mass hypothesis, which maximize the likelihood.

(Ref: R.Forty: Nucl. Inst. Mech. A 433 (1999) 257-261)

51



# LHCb RICH: PID performance

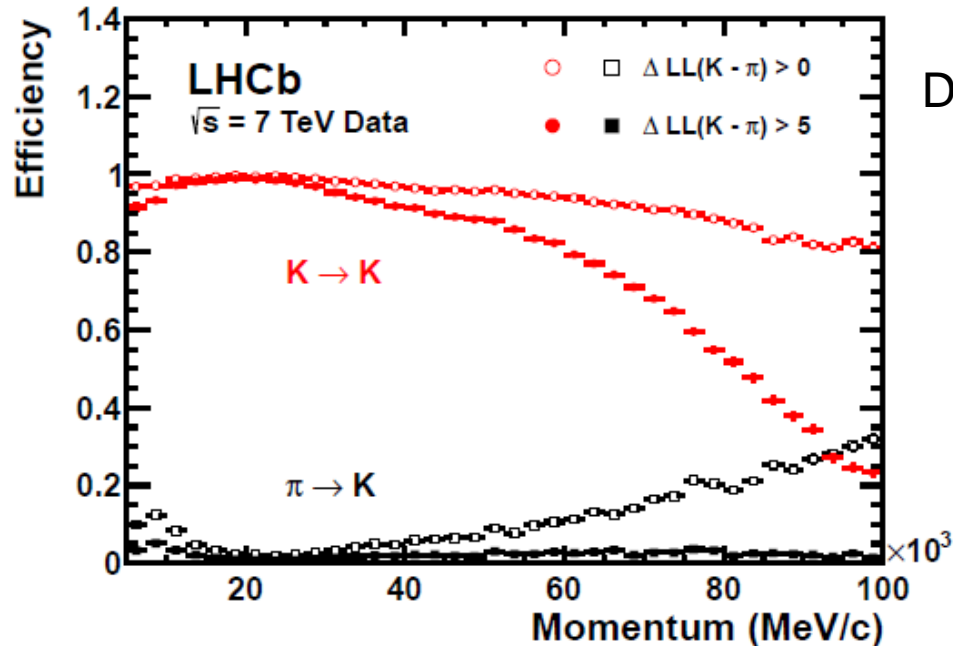

Data

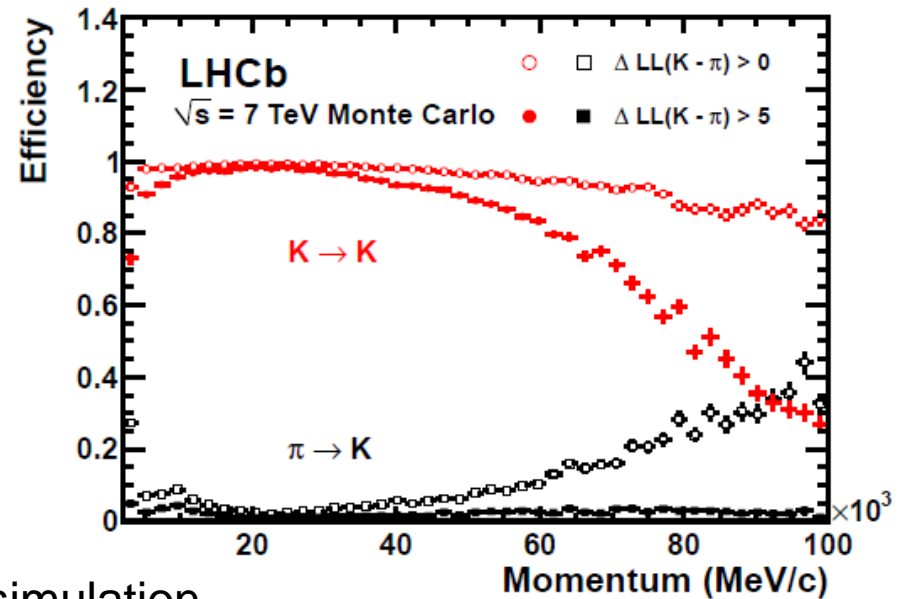

*Red: Kaon identification efficiency*  
*Black: Pion mis-identification probability*  
*PID performance in  $D^*$  events (calibration channel)*

General agreement between real data and simulation



# Physics impact of hadron PID

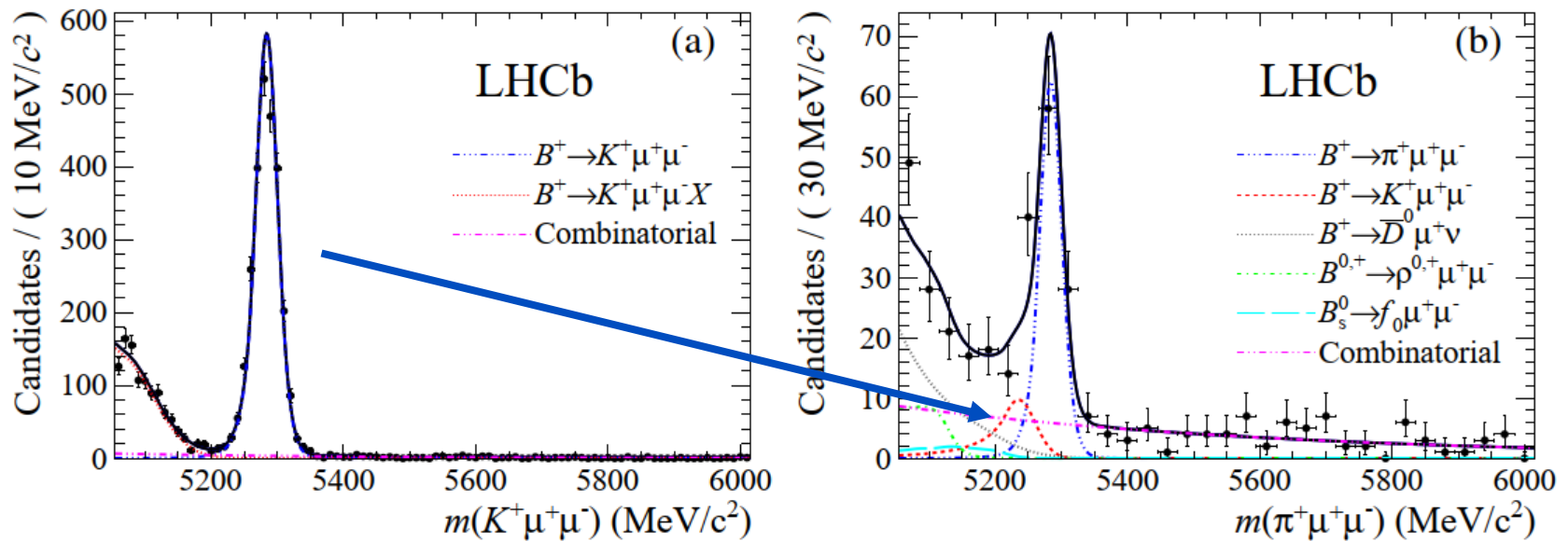

First measurement of the differential branching fraction and  $CP$  asymmetry of the  $B^\pm \rightarrow \pi^\pm \mu^+ \mu^-$  decay, JHEP 10 (2015) 034 [arXiv:1509.00414]

# How to make a better RICH detector

- Increase the number of photons
  - Better photon detectors (photo-cathodes)
  - Better area coverage by photon detectors
  - Better optical coupling of components
- Improve Cherenkov angle resolution
  - Smaller pixels
  - Lower chromatic error
    - Detectors sensitive to green rather than blue
  - Improve aberrations
    - Light weight mirrors in the acceptance

# The LHCb RICH Upgrade (i)

## Continuous 40 MHz readout

- MaPMTs from Hamamatsu
- New radiation hard ASIC (CLARO) for MaPMT readout
- FPGA based digital board
- GBT for data transmission

R13742 (1'')  
RICH1 and  
RICH2

R13743 (2'')  
RICH2 only

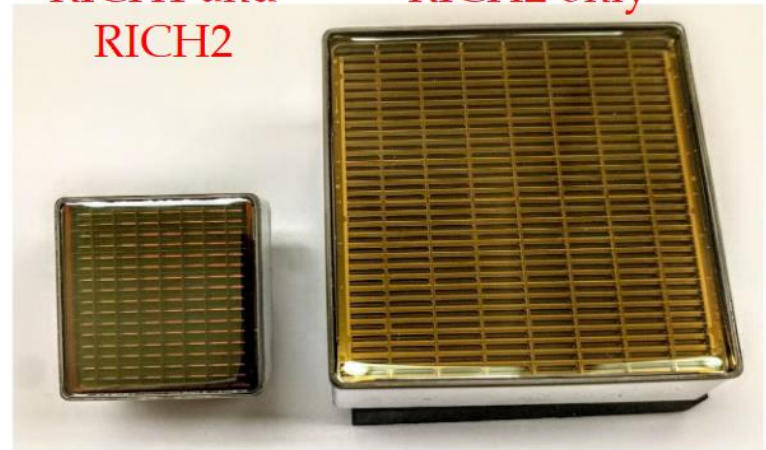

## Single photon spectrum

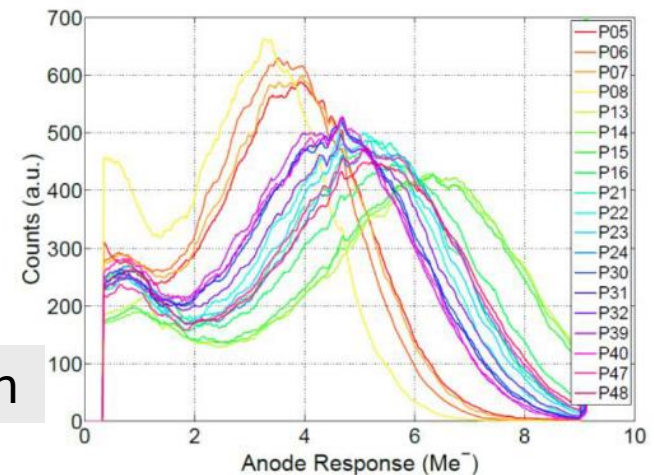



# The LHCb RICH Upgrade (ii)

## More complex events

- Completely new RICH1
- New mirrors with longer focus
- New position for the photon detectors
- New gas enclosure, exit window, cooling and support structures

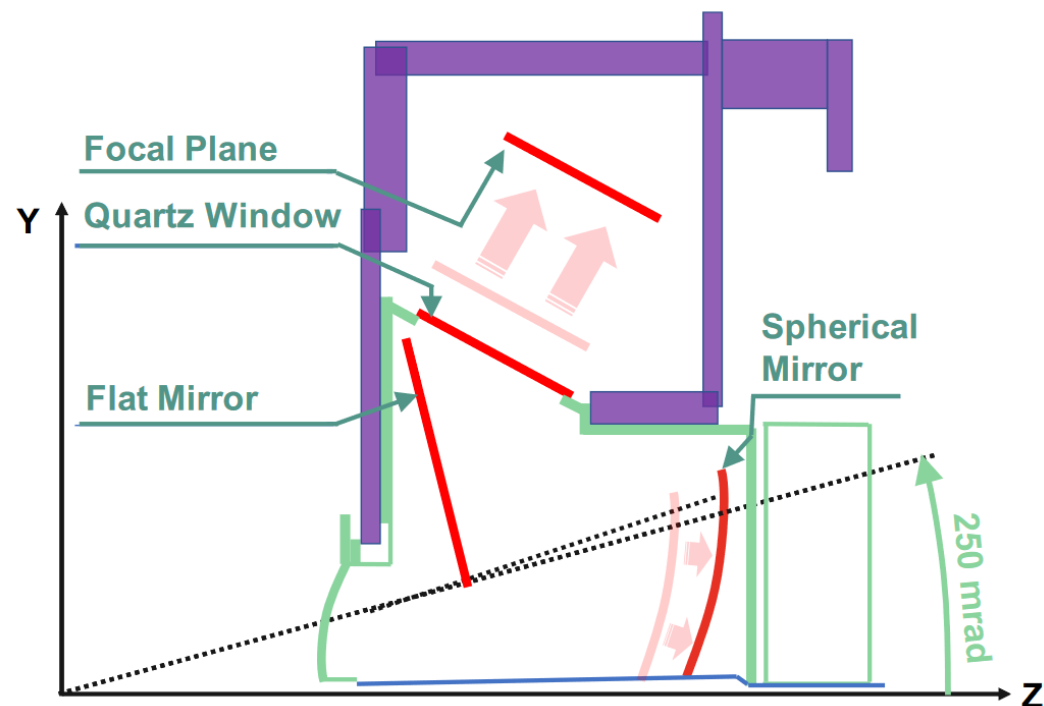



# Cherenkov angle resolution

Contributions to resolution (in mrad)	RICH1-2015 HPD	RICH1-Upgrade MaPMT	RICH2-2015 HPD	RICH2-Upgrade MaPMT
Chromatic	0.84	0.58	0.48	0.31
Pixel	0.60, PSF=0.86	0.44	0.19, PSF=0.29	0.19
Emission Point	0.76	0.37	0.27	0.27
<b>Overall</b>	<b>1.60</b> →	<b>0.78</b>	<b>0.65</b> →	<b>0.45</b>

Improvements due to:

- ❑ Chromatic error; MaPMTs QE peaks at higher wavelength
- ❑ No Point Spread Function for MaPMTs
- ❑ Better emission point error with new RICH1 geometry

# Future (LHCb) Upgrades

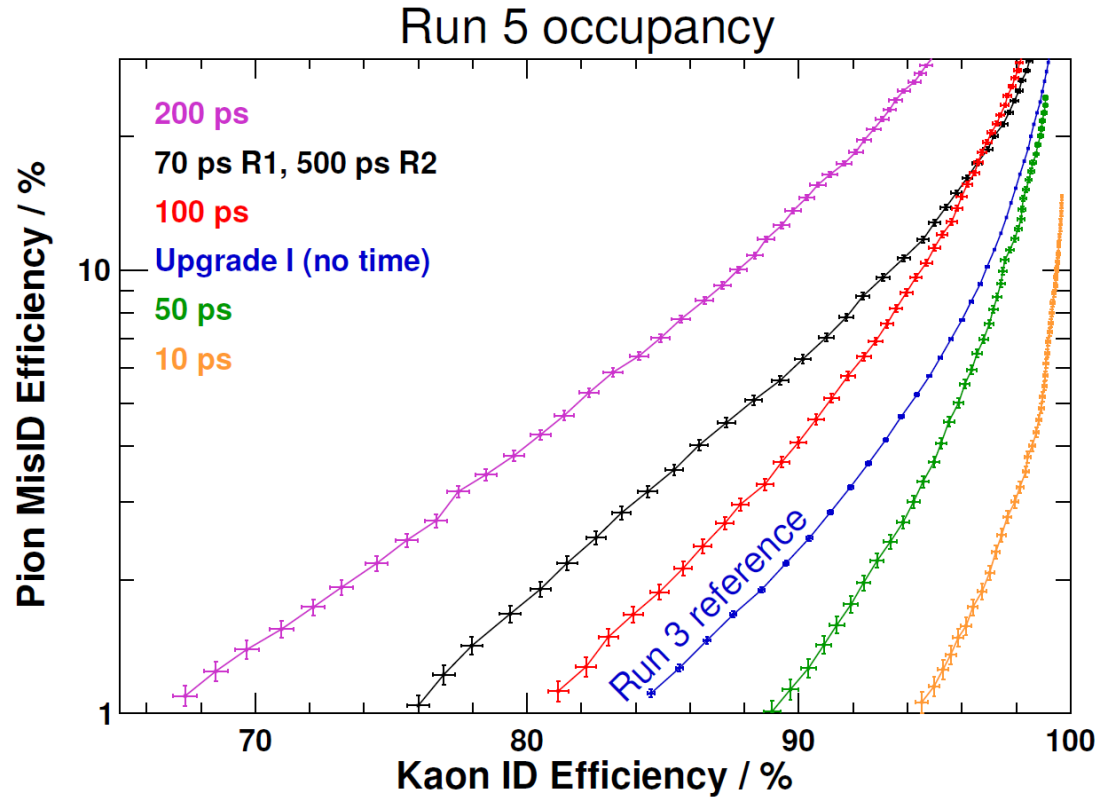

Improve pattern recognition using accurate timing of primary vertices



# Evolution of the RICH photon detection

Relatively long period of LS3 central to the RICH evolution.

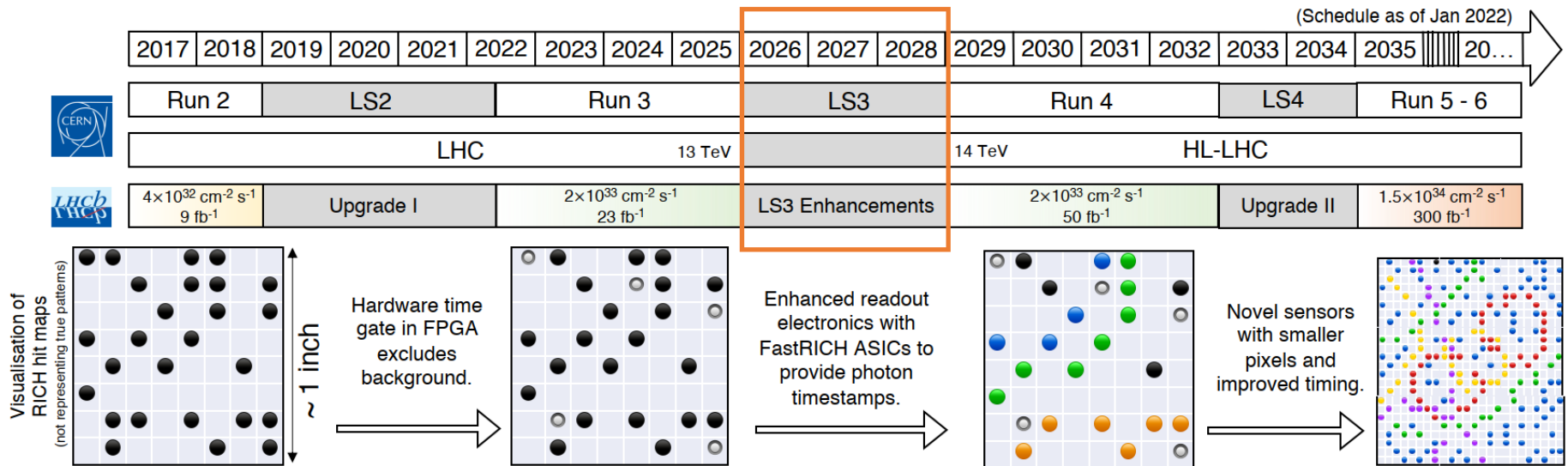

- LS3 / Run 4 : focus on **FastRICH** readout electronics with fast timing and wide input dynamic range.
- LS4 / Run 5 : focus on **sensor technology**. Fast-timing is essential for the luminosity challenge after Upgrade II.

# DIRC

- Direct Internally Reflected Cherenkov light
- Detectors outside the “acceptance”
- Can fit in a narrow space

**DIRC**

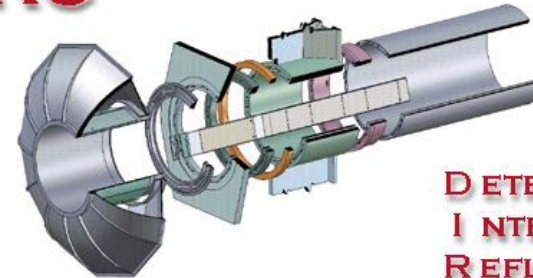

**DETECTION OF  
I NTERNALLY  
R E F L E C T E D  
C H E R E N K O V L I G H T**

The standoff region is designed to maximize the transfer efficiency between the radiator and the detector.

If this region has the same index of refraction as the radiator,  $n_1 \cong n_2$ , the transfer efficiency is maximized and the image will emerge without reflection or refraction at the end surface.

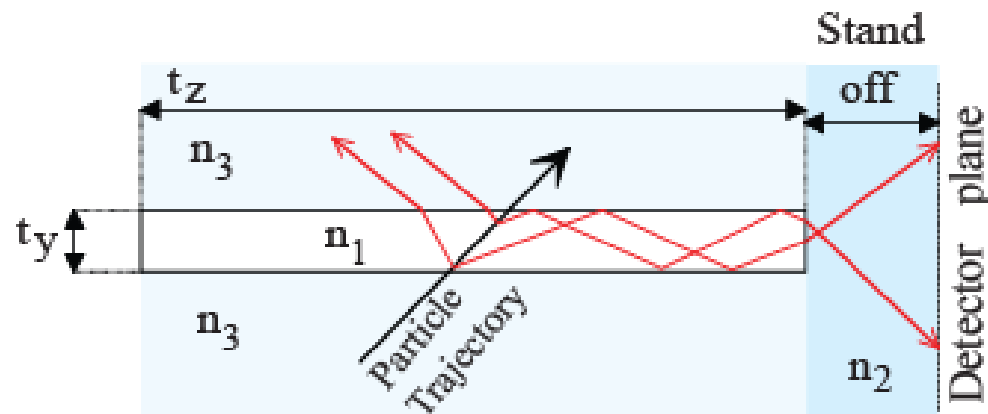

# Babar DIRC

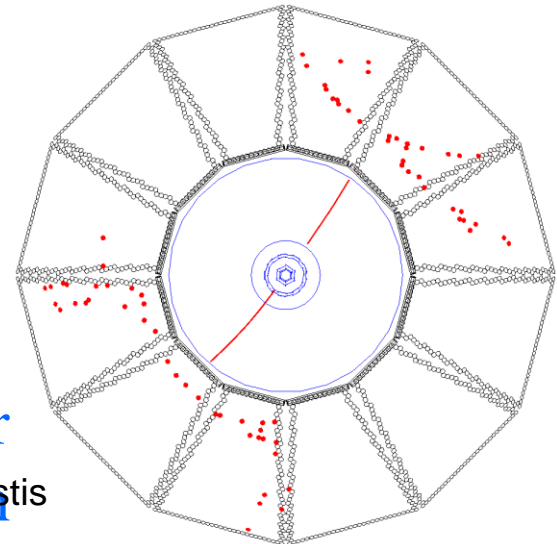
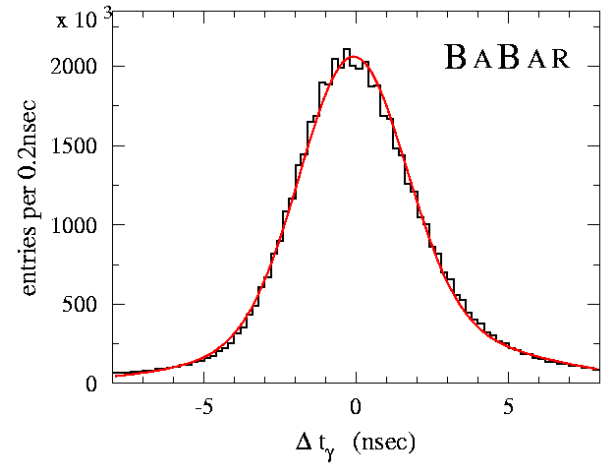
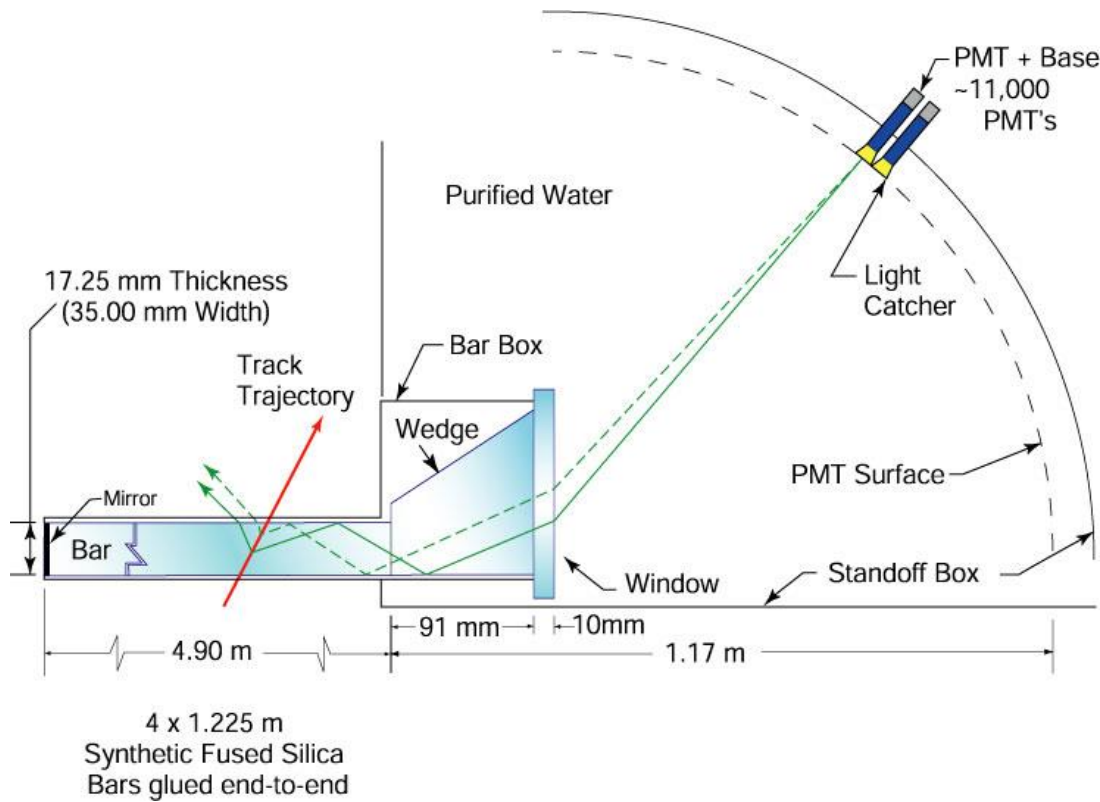

$\pm 8$  ns  $\Delta t$  window for  
background rejection

Warwick Week 2023 - A Papanestis



# Panda Barrel DIRC

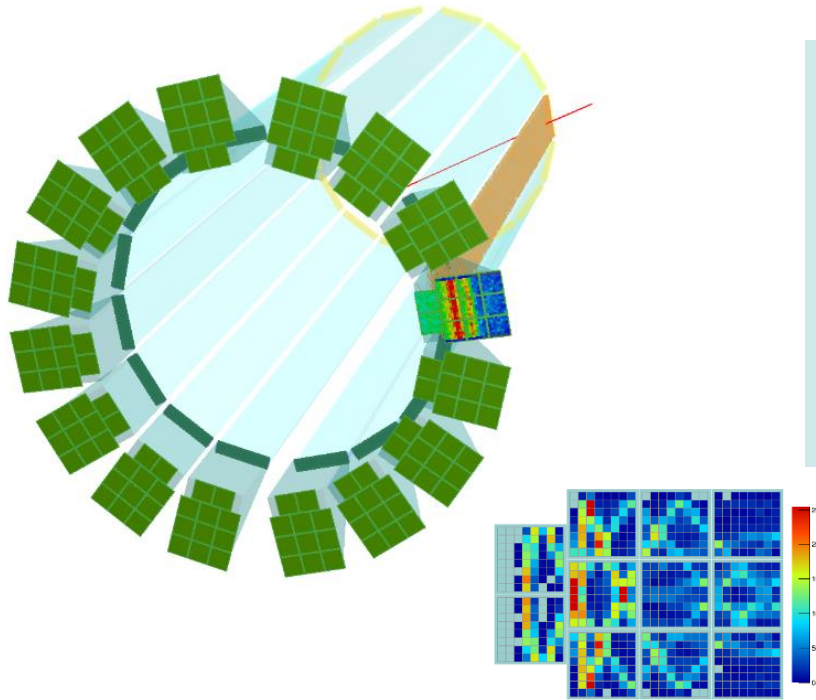

- ❑ DIRC detector following the design principles of the BABAR DIRC
- ❑ Very compact Expansion Volume
- ❑ Focusing optics; NLaK33 ref index 1.786
- ❑ Photon detectors: MCP-PMTs; use of timing information

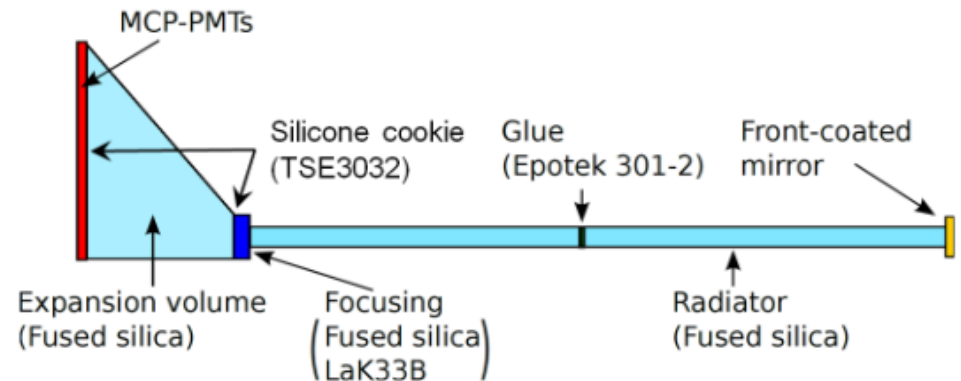
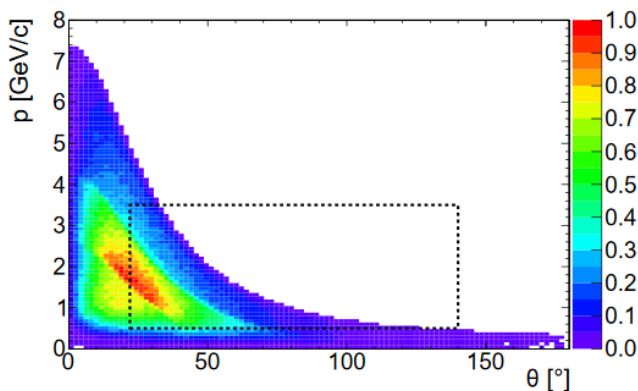

# TORCH (i)

A time of flight detector based on Cherenkov radiation

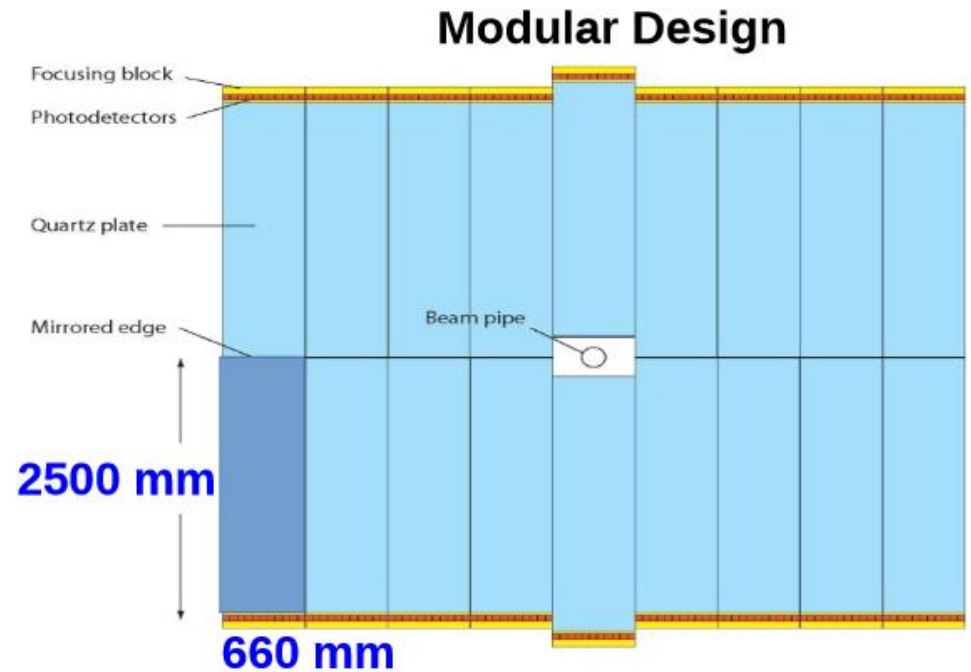
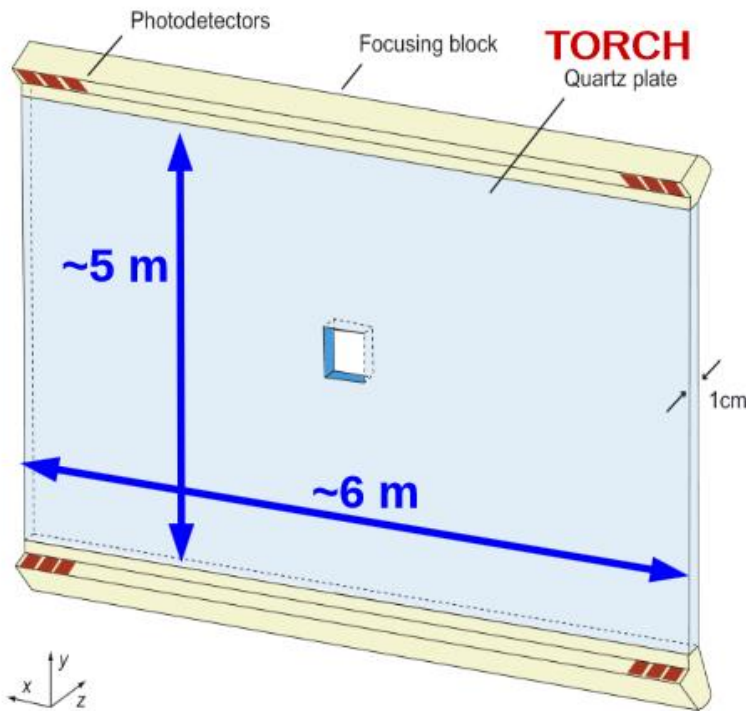



# TORCH (ii)

The focusing unit converts angles to positions allowing the measurement of propagation time

Multiple photons from the same track can improve the time accuracy

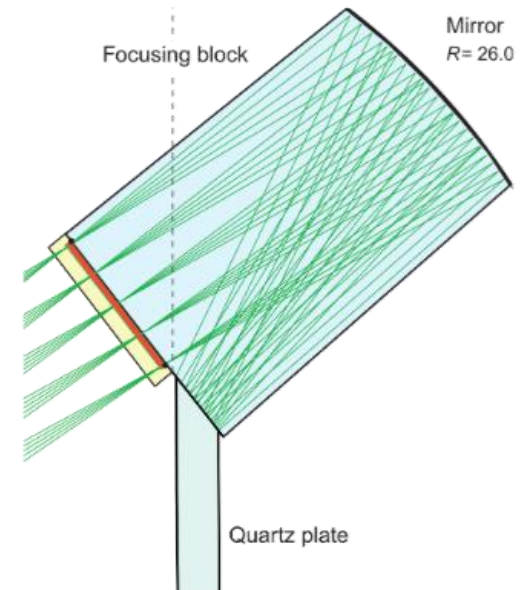
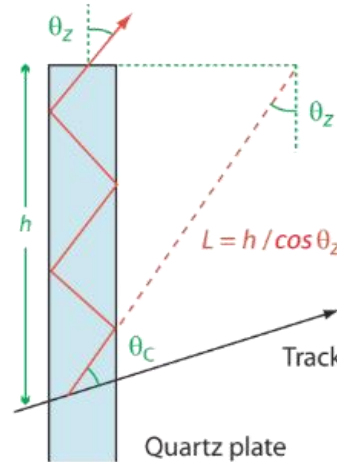
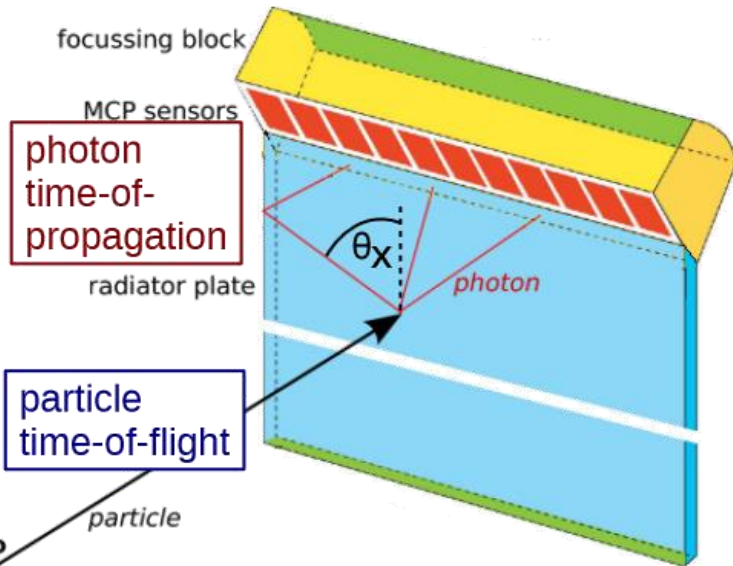
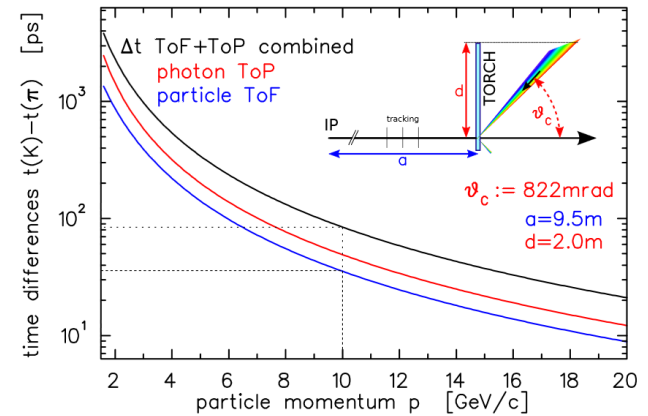



# Photonic Crystals

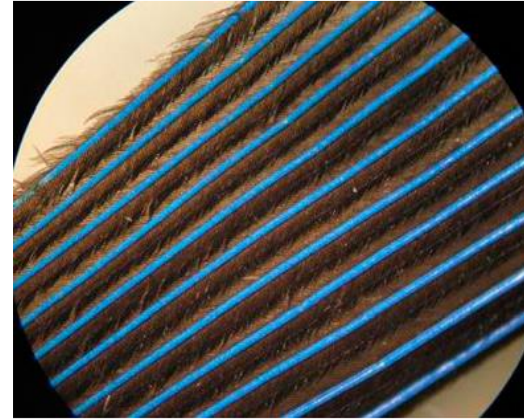

Optical micrograph of blue feather barbs

[www.pnas.org/cgi/doi/10.1073/pnas.1204383109](http://www.pnas.org/cgi/doi/10.1073/pnas.1204383109)

Parrot (scarlet macaw) in a tropical forest

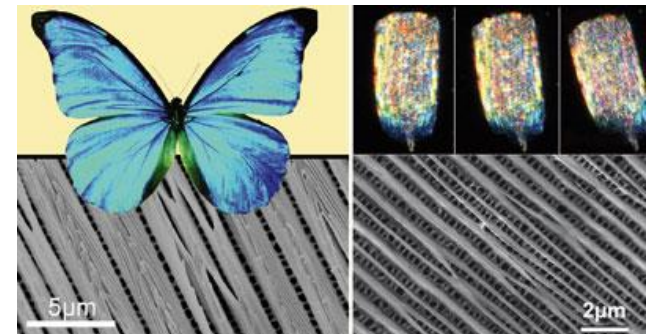
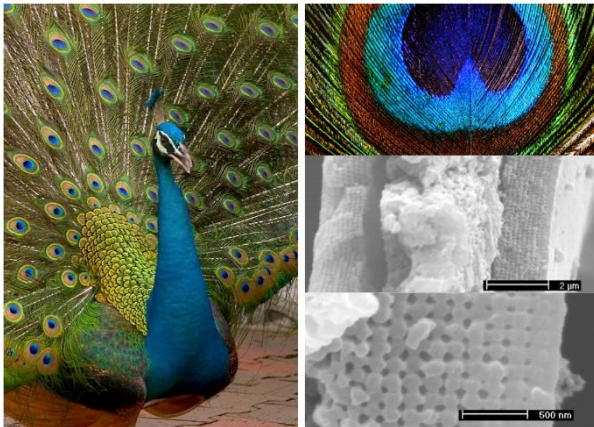

CERN Courier Aug23, 2005  
Phys. Rev. E 72, 010902 (2005)

# Photonic Crystals

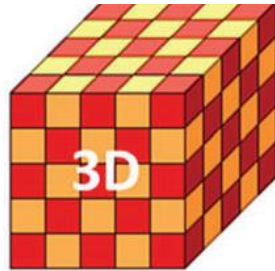
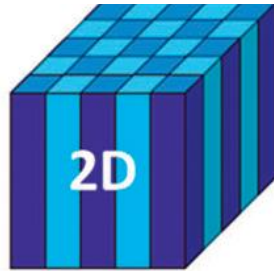
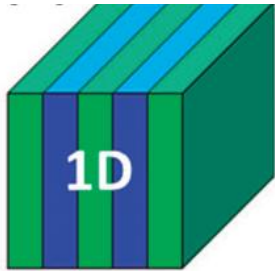

- Periodic arrangement of objects with two different refractive indices.
- Lattice constants comparable to the wavelength of light in the material
- electrons in pure semi-conductor : similar features to photons in photonic crystal

## ▪ Cherenkov radiation:

- Physical origin is a mixture of conventional Cherenkov radiation and Transition radiation
- Photon propagation in the crystal in the form of Bloch waves
- All the properties can be derived from solving Maxwell's equations for periodic lattice
- There is no Cherenkov Threshold
- Cherenkov cone can be forward or backward

[arXiv:0808:3519](https://arxiv.org/abs/0808.3519)

- Starting from two media with refractive indices  $n_1$  and  $n_2$ , create a new effective refractive index  $n_3$ .

$r$ =cylinder radius  
 $a$ = lattice constant

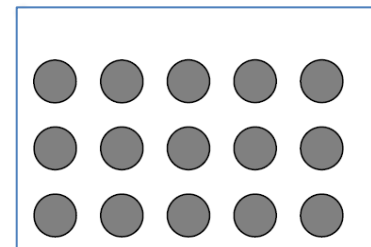

# Summary

- The field of Particle Identification Detectors is an evolving field.
- They have contributed to some of the important discoveries in High Energy Physics in the last 50 years and they continue to be a crucial part of some of the recent experiments.
- The RICH detectors offer excellent Particle Identification capability for the hadrons since they can be designed to have very good single photon Cherenkov Angle resolution and large Photoelectron yield. Recent advances in photodetectors enhance the capability of these detectors.
- The particle ID using  $dE/dx$ , time-of-flight and Transition Radiation detectors continue to provide Particle Identification in different experiments.
- Particle identification is a crucial part of some of the Astroparticle physics experiments and long base line neutrino experiments

**The end**

**Thank you for  
your attention**

**Any (more) questions?**



# Features of the PMTs and HPDs

- PMT:
  - Typical Gain of MAPMT 300 K.
  - Excellent time resolution: 125 ps for example (Ex: used in underwater Cherenkov detectors).
  - Active area fraction: 40 % : Fraction of effective detection area. This can be Improved with a lens, but then one may loose some photons at the lens surface.
  - Recent developments: Flat panel pmts with 89 % active area fraction. New photocathodes with >45% QE at 400 nm
- HPD:
  - Typical gain 5K, but quite uniform across different channels.
  - Excellent Single photon identification capability.
  - Active area fraction: 35 → 76 %



# DIRC PRINCIPLE

- If  $n > \sqrt{2}$  some photons are always **totally internally reflected** for  $\beta \approx 1$  tracks.
- **Radiator and light guide**: Long, rectangular **Synthetic Fused Silica** (“Quartz”) bars (*Spectrosil*: average  $\langle n(\lambda) \rangle \approx 1.473$ , radiation hard, homogenous, **low chromatic dispersion**)
- Photons exit via wedge into **expansion region** (filled with  $6\text{m}^3$  pure, de-ionized water).
- Pinhole imaging on **PMT array** (bar dimension small compared to standoff distance). (10,752 **traditional PMTs ETL 9125**, immersed in water, surrounded by hexagonal “light-catcher”, transit time spread  $\sim 1.5\text{nsec}$ ,  $\sim 30\text{mm}$  diameter)
- **DIRC is a 3-D device**, measuring:  $x$ ,  $y$  and **time** of Cherenkov photons, defining  $\theta_c$ ,  $\phi_c$ ,  $t_{\text{propagation}}$  of photon.

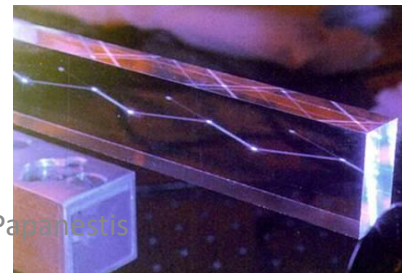
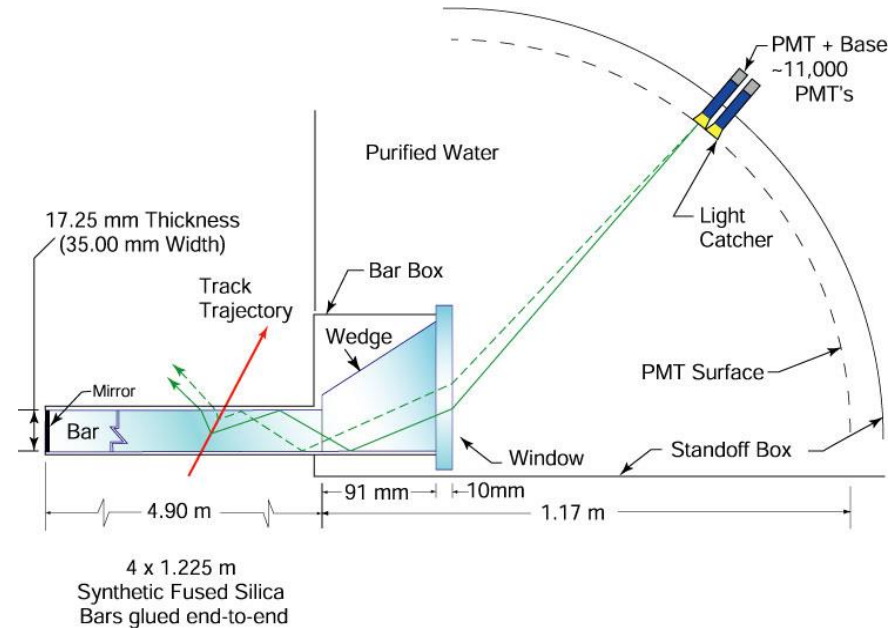

# DIRC PERFORMANCE

Number of Cherenkov photons  
per track (di-muons) vs. polar angle:

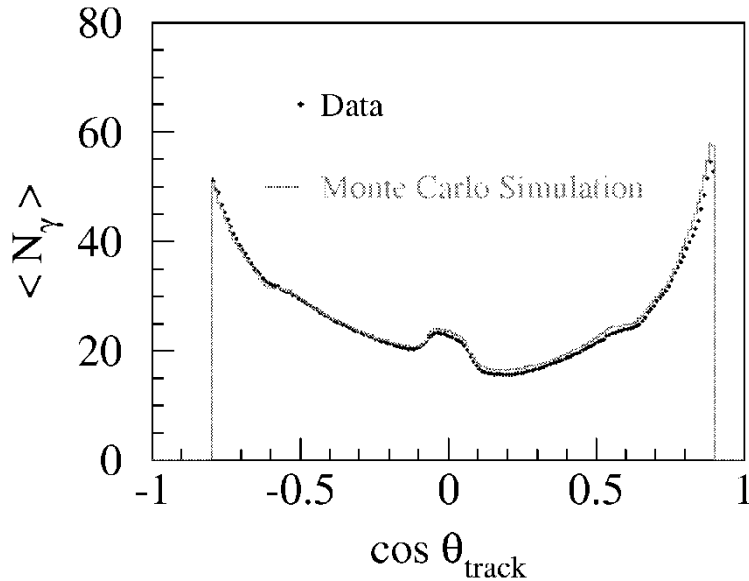

Between 20 and 60 signal photons per track.

Resolution of Cherenkov angle fit  
per track (di-muons):

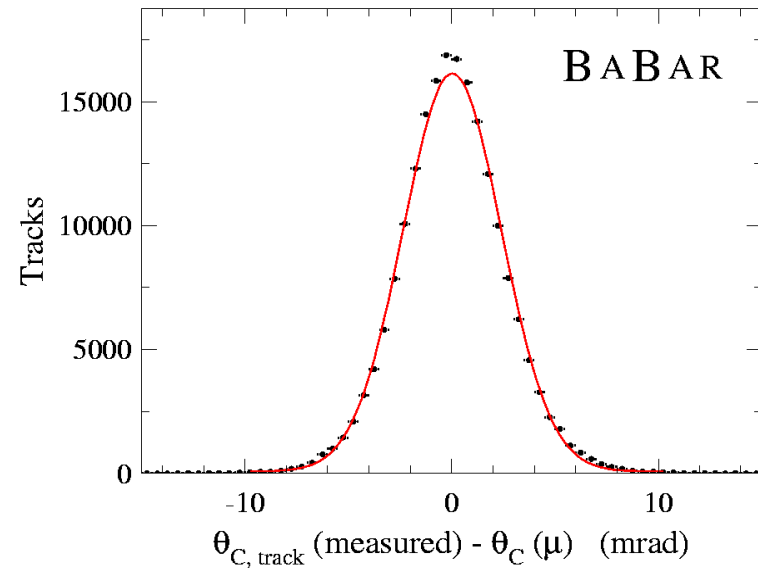

$$\sigma(\Delta\theta_c) = 2.4 \text{ mrad}$$

Track Cherenkov angle resolution is  
within  $\sim 10\%$  of design



# DIRC PERFORMANCE

Kaon selection efficiency typically above 95% with mis-ID of 2-10% between 0.8-3 GeV/c.

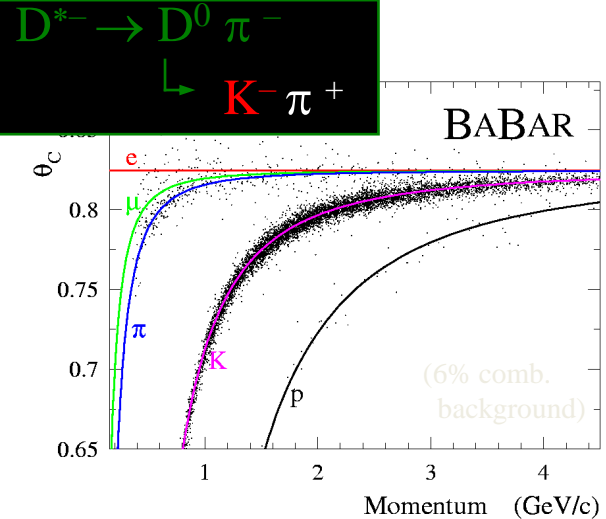

**Kaon selection efficiency for  $\mathcal{L}^K > \mathcal{L}^\pi$**

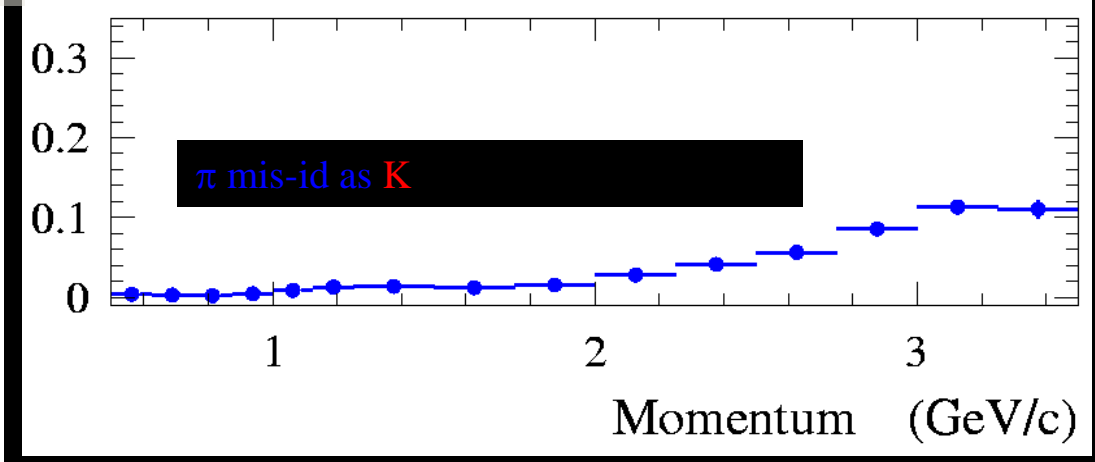
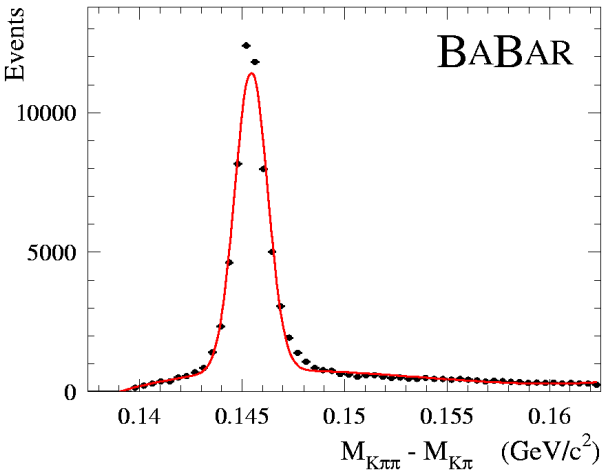
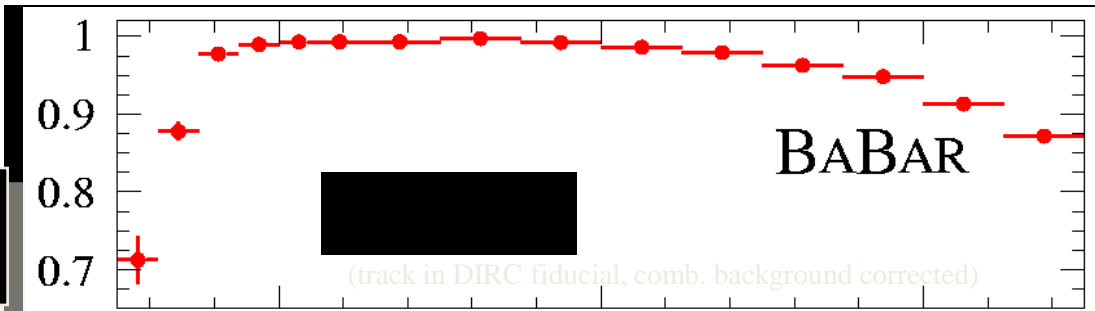

## New Development: Focussing DIRC

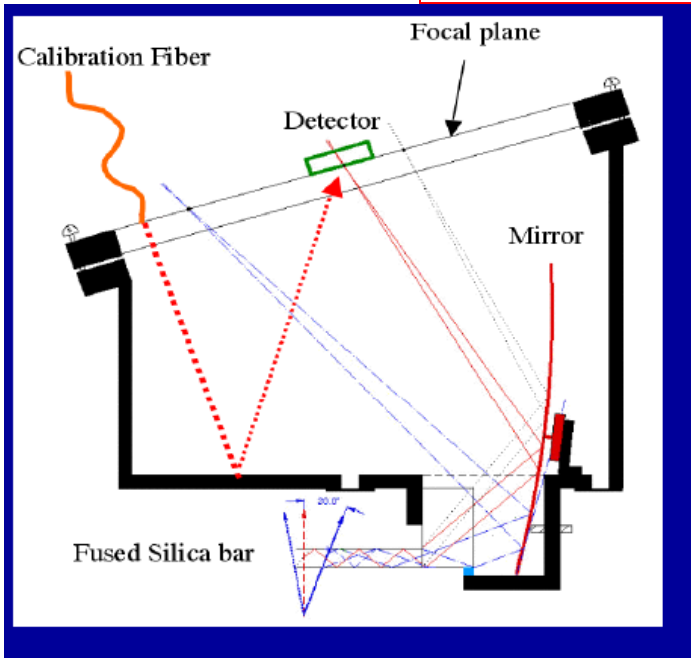

$$v_{\text{group}}(\text{red}) > v_{\text{group}}(\text{blue})$$

- Red photons arrive before blue photons
- Time of Propagation = PathLength /  $v_{\text{group}}$
- Correct for Chromatic error from the measurement of time of propagation.

→ Future DIRC needs to be smaller and faster:

Focusing and smaller pixels can **reduce the expansion volume by a factor of 7-10**

Faster PMTs reduce sensitivity to background.

Additional benefit of the faster photon detectors:

- Timing resolution improvement:  $\sigma \sim 1.7\text{ns}$  (BABAR DIRC)  $\rightarrow \sigma \leq 150\text{ps}$  ( $\sim 10\text{x}$  better) which allows measurement of photon color to correct the chromatic error of  $\theta_c$  (contributes  $\sigma \sim 5.4$  mrad in BABAR DIRC)

Focusing mirror effect:

- Focusing eliminates effect of the bar thickness (contributes  $\sigma \sim 4$  mrad in BABAR DIRC)
- However, the spherical mirror introduces an aberration, so its benefit is smaller.

Ref: NIMA 595(2008)104-107

## Gas Based Photon Detectors

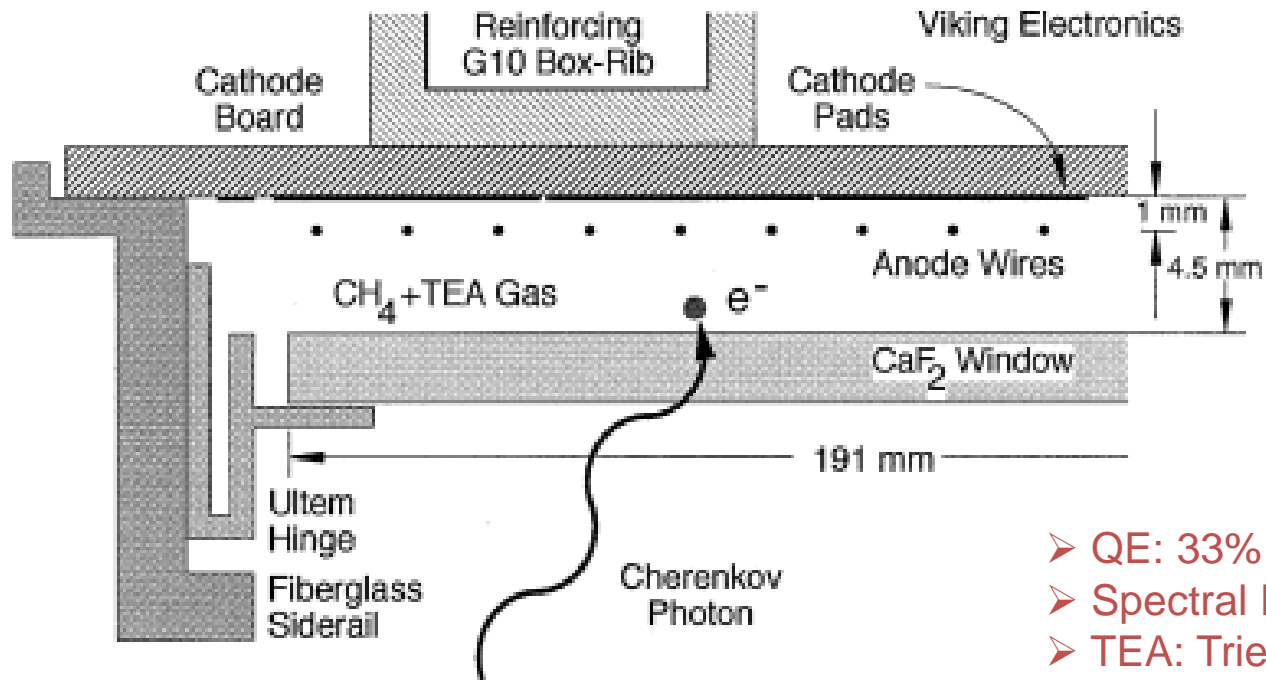

### Photon Detector of the CLEO-III Cherenkov detector

- photon passes through the  $\text{CaF}_2$  and converts to photoelectron by ionizing a TEA molecule.
- The photoelectron drifts towards and avalanches near the anode wires, thereby inducing a charge signal on the cathode pads.

Balloon Experiment:  
RICH detector

CAPRICE Experiment

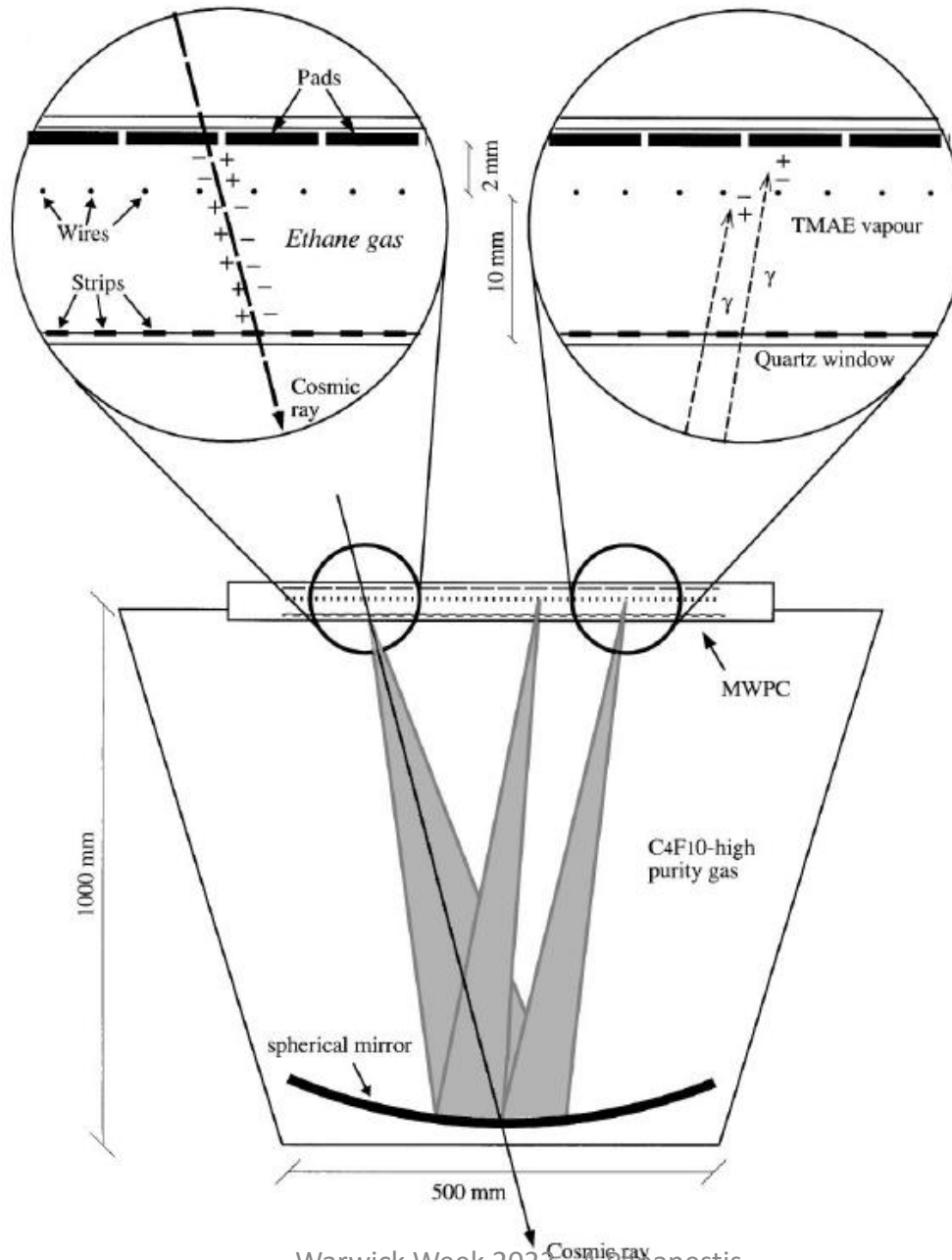

TMAE:  
(tetrakis(dimethylamino)  
ethylene)

## Components of a Cherenkov Detector

- Main Components:
  - Radiator : To produce photons
  - Mirror/lens etc. : To help with the transport of photons
  - Photodetector : To detect the photons

➤ Radiator: Any medium with a Refractive Index.

### Example of radiators

Medium	n-1	$\gamma_{th}$	Photons/m
He (STP)	$3.5 \cdot 10^{-5}$	120	3
CO <sub>2</sub> (STP)	$4.1 \cdot 10^{-4}$	35	40
Silica aerogel	0.025-0.075	4.6-2.7	2400-6600
water	0.33	1.52	21300
Glass	0.46-0.75	1.37-1.22	26100-33100

Aerogel: network of SiO<sub>2</sub> nano-crystals

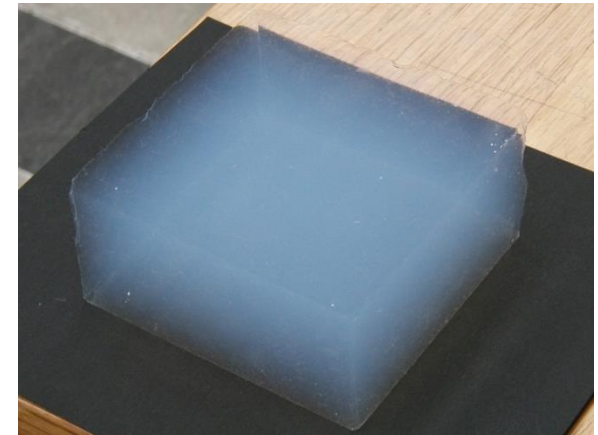

$$\gamma = 1/\sqrt{1-\beta^2}$$

- The atmosphere, ocean are the radiators in some Astro Particle Cherenkov Detectors

# LHCb-RICH Design

**RICH1: Aerogel** L=5cm p:2→10 GeV/c  
n=1.03 (nominal at 540 nm)

**C<sub>4</sub>F<sub>10</sub>** L=85 cm p: < 70 GeV/c  
n=1.0014 (nominal at 400 nm)

Upstream of LHCb Magnet

Acceptance: 25→250 mrad (vertical)  
300 mrad (horizontal)

Gas vessel: 2 X 3 X 1 m<sup>3</sup>

**RICH2: CF<sub>4</sub>** L=196 cm p: < 100 GeV/c  
n =1.0005 (nominal at 400 nm)

Downstream of LHCb Magnet

Acceptance: 15→100 mrad (vertical)  
120 mrad (horizontal)

Gas vessel : 100 m<sup>3</sup>

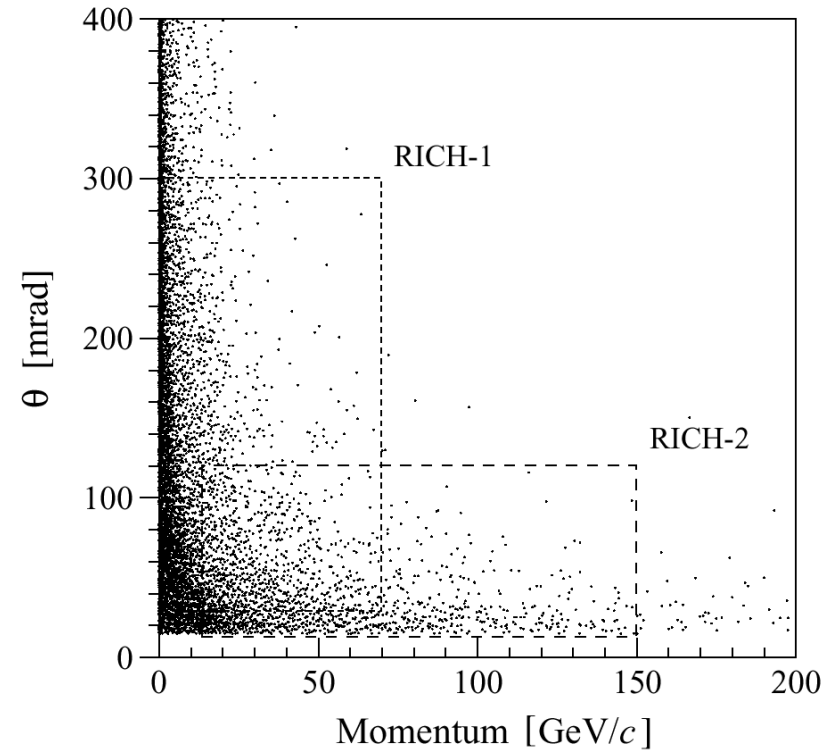

# LHCb RICH Data in Physics Analysis

Without RICH data

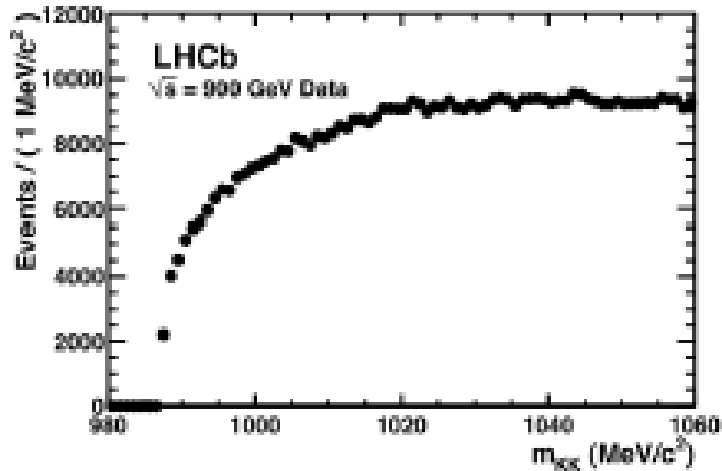

With RICH data

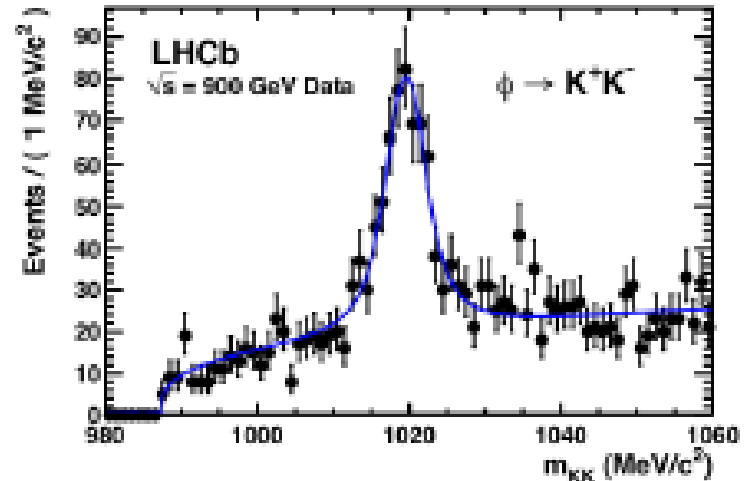

$\phi \rightarrow K^+ K^-$

Status in 2011  
using RICH data

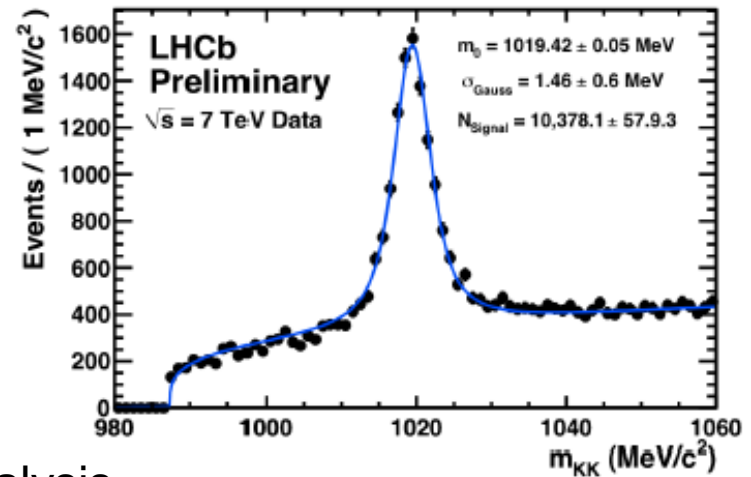

RICH data has been used in Physics analysis



# Example of LHCb-RICH PERFORMANCE

- Performance as seen in Simulated Data in 2010
- **Yield: Mean Number of hits per isolated saturated track ( $\beta \sim 1$ ).**

<b>Aerogel</b>	<b>C4F10</b>	<b>CF4</b>
<b>4.6</b>	<b>34.0</b>	<b>24</b>

## Single Photon Cherenkov Angle Resolutions in mrad.

<b>Components and Overall (mrad)</b>	<b>Aerogel</b>	<b>C<sub>4</sub>F<sub>10</sub></b>	<b>CF<sub>4</sub></b>
<b>Chromatic</b>	<b>2.65</b>	<b>0.84</b>	<b>0.48</b>
<b>Emission Point</b>	<b>0.34</b>	<b>0.61</b>	<b>0.27</b>
<b>Pixel Size</b>	<b>0.59</b>	<b>0.6</b>	<b>0.19</b>
<b>PSF</b>	<b>0.78</b>	<b>0.79</b>	<b>0.29</b>
<b>Overall RICH</b>	<b>2.84</b>	<b>1.45</b>	<b>0.65</b>
<b>Overall RICH+Tracks</b>	<b>2.86</b>	<b>1.50</b>	<b>0.76</b>

- **Chromatic:** From the variation in refractive index.
- **Emission Point:** Essentially from the tilt of the mirrors.
- **Pixel Size:** From the granularity of the Silicon detector pixels in HPD
- **PSF ( Point Spread Function):**  
From the spread of the Photoelectron direction as it travels inside the HPD, (from the cross focussing in the electron optics)

## Differential Cherenkov Detectors

- Very small acceptance in  $\beta$  and direction of the charged particle. (Narrow range in velocity and direction intervals ).
- From the Cherenkov angle ( $\theta$ ) determine  $\beta$ .
- Mostly used for identifying particles in the beam lines.
- Resolution that can be achieved =  $\Delta \beta / \beta = (m_1^2 - m_2^2) / 2 p^2 = \tan \theta \Delta \theta$   
 $m_1, m_2$  (particle masses)  $\ll p$  ( momentum)
- At high momentum, to get better resolution, use gas radiators which have smaller refractive index than solid radiators. Have long enough radiators to get sufficient signal photons in the detector.
- To compensate for Chromatic dispersion ( $n(E_{ph})$ ), lens used in the path of the photons. (DISC: Differential Isochronous self- collimating Cherenkov Counter).
- $\Delta \beta / \beta$  from 0.011 to  $4 \cdot 10^{-6}$  achieved.

# Differential Cherenkov Detectors

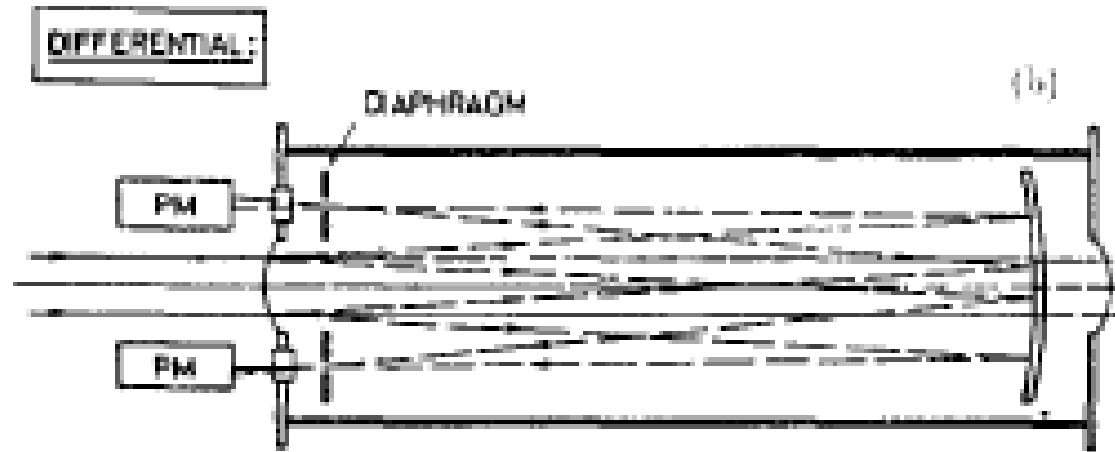

With a Gas radiator

Table 2  
Some differential Cherenkov counters

Type	Year	Length [m]	Angle [mrad]	Gas	Range for ( $\pi$ -K) [GeV/c]	Remarks	Ref.
IHEP [1]	1968	5	23	He, N <sub>2</sub>	< 100	no optical correction	[3]
[2]		10	12		< 200		
DISC	1964	2	44	CO <sub>2</sub>	< 100	corrected	[4]
FNAL DISC	1973	5.5	25	He	< 500	Id.	[2]
					( < 100 for $\pi$ - $\mu$ -e)		
CEDAR W	1976	3.25	31	N <sub>2</sub>	< 150	Id	[5]
N		3.90	26	He	< 340		
HYPERON DISC	1972	0.3	120	SF <sub>6</sub>	< 40	Id.	[2]
					( < 100 for $\Sigma$ -p)		
For comparison: LDISC	1976	0.05	640	FC88 liquid	< 5	corrected high aperture	[6]

## Threshold Cherenkov Detectors

- Can be used over a large area, for Example : For secondary particles in a fixed target or Collider experiment.
- E691 at Fermilab: To study decays of charm particles in the 1980's  
 $\Delta\beta/\beta = 2.3 * 10^{-5}$  using gas radiator.
- BELLE Experiment: To observe CP violation in B-meson decays at an electron-positron collider.

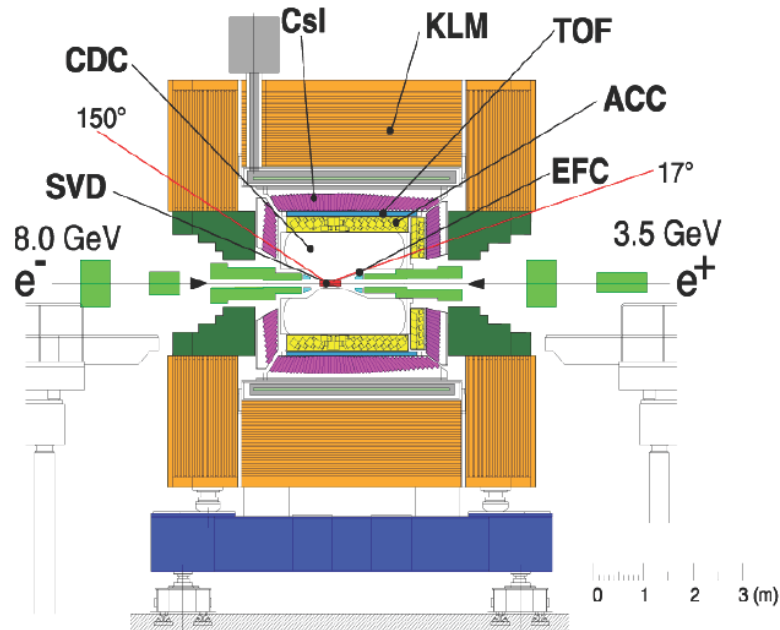

- BELLE: Continues to take Data.

# LHCb-RICH2 SCHEMATIC

## RICH2 Optics Top View

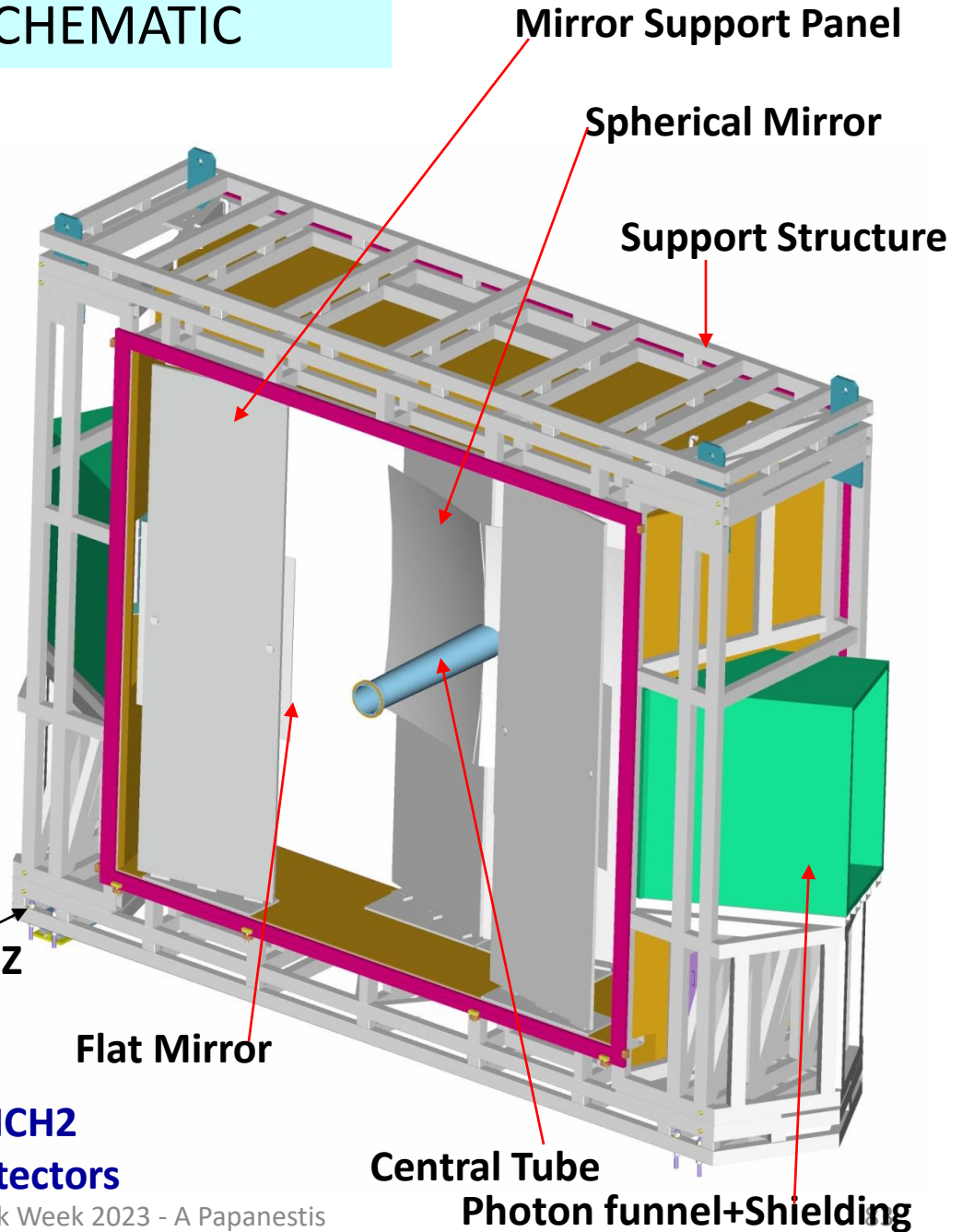
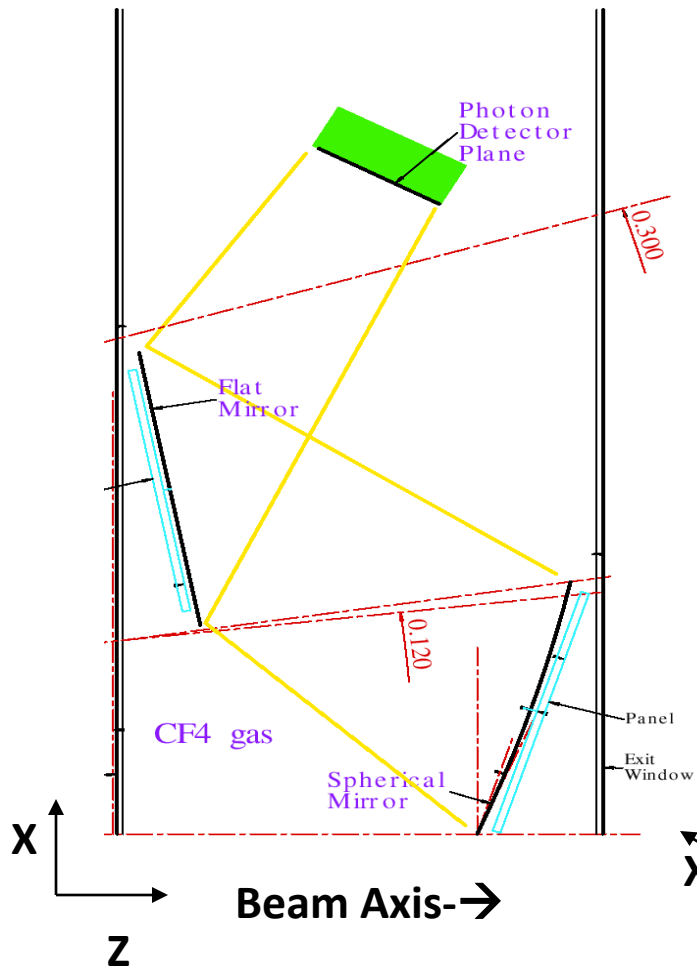

- Plane Mirrors to reduce the length of RICH2
- Spherical mirror tilted to keep photodetectors outside acceptance. (tilt=0.39 rad)

# LHCb- RICH2 STRUCTURE

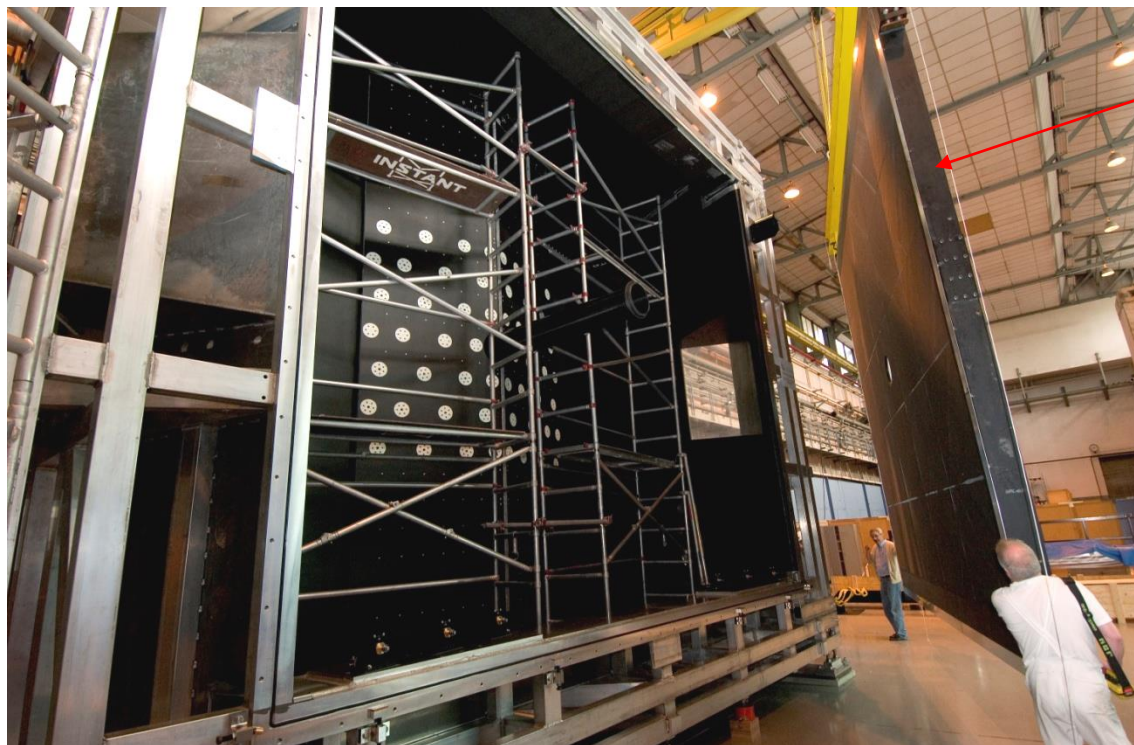

**Entrance Window  
(PMI foam between two  
carbon fibre epoxy Skins)**



RICH2

## RICH detectors

➤  $\Delta \beta / \beta = \tan(\theta) * \Delta \theta_c = K$  where  $\Delta \theta_c = \langle \Delta \theta \rangle / \sqrt{N_{ph}} + C$

where  $\langle \Delta \theta \rangle$  is the mean resolution per single photon in a ring and C is the error contribution from the tracking, alignment etc.

➤ For example, for 1.4 m long  $CF_4$  gas radiator at STP and a detector with  $N_0 = 75 \text{ cm}^{-1}$   
 $K = 1.6 * 10^{-6}$ . (  $E=6.5 \text{ eV}$ ,  $\Delta E = 1 \text{ eV}$  )

- This is better than similar Threshold counters by a factor 125.
- This is also better than similar Differential counters by a factor 2.

Reason: RICH measures both  $\theta$  and  $N_{ph}$  directly.  
 ➤ RICH detectors have better resolution than equivalent Differential and Threshold counters.

➤ Let  $u = \sin^2(\theta) = 1 - (1/n^2) - (m/p * n)^2$

Number of standard deviations to discriminate between mass  $m_1$  and  $m_2$   
 $= N_\sigma = (u_2 - u_1) / (\sigma_u * \sqrt{N})$  where  $\sigma_u$  :  $\Delta \theta$  converted into the parameter u.  
 (  $\Delta \theta$  = error in single photon  $\theta$  measurement )

➤ At momentum  $p$  ( $=\beta E$ ),  $p = \sqrt{((m_2^2 - m_1^2) / (2 * K * N_\sigma))}$ , for  $\beta \sim 1$

This equation can be used in the design of the RICH detectors.

➤ One the first large size RICH detector: in DELPHI at LEP.



# History of Cherenkov radiation

- The formula  $\cos(\theta) = 1/(n\beta)$  was already predicted by Heaviside in 1888
- ~1900: 'Blue glow' seen in fluids containing concentrated Radium (Marie & Pierre Curie)
- Pavel Alexeevich Cherenkov (1904-1990): Lebedev Physical Institute of the Russian Academy of Sciences.
- Discovery and Validation of Cherenkov Effect : 1934-37
- Full Explanation using Maxwell's equations: I.M. Frank and I.E. Tamm in 1937
- Nobel Prize in 1958: Cherenkov, Frank and Tamm.

# First experiments

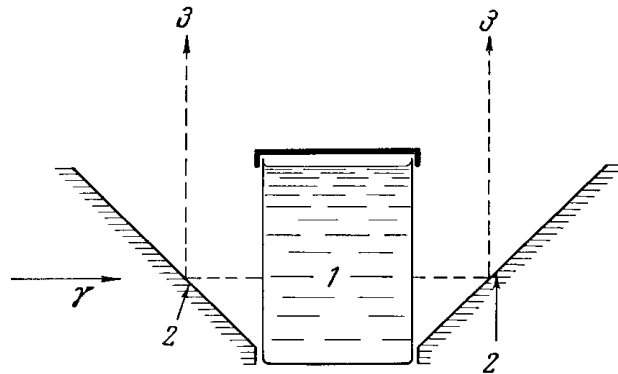

- 1: vessel with liquid
- 2: mirror
- 3: Cherenkov photons towards the photographic plate

**Typical Apparatus used by Cherenkov to study the angular distribution of Cherenkov photons. (Incident  $\gamma$  ray produces electrons by Compton scattering in the liquid).**

P. Cherenkov established that:

- Light Intensity is proportional to the electron path length in the medium.
- Light comes only from the 'fast' electrons above a velocity threshold, in his Apparatus.
- Light emission is prompt and the light is polarized.
- The wavelength spectrum of the light produced is continuous. No special spectral lines.
- The angular distribution of the radiation, its intensity, wavelength spectrum and its dependence on the refractive index agree with the theory proposed by his colleagues Frank and Tamm.

