

Lecture 2 - ATLAS and CMS

Juraj Bracinik, Andrew Chisholm
(University of Birmingham)

Warwick week, 12 April 2023

- ◆ Introduction
- ◆ LHC machine
- ◆ High P_T experiments - Atlas and CMS
- ◆ Standard Model physics and BSM
- ◆ Higgs physics

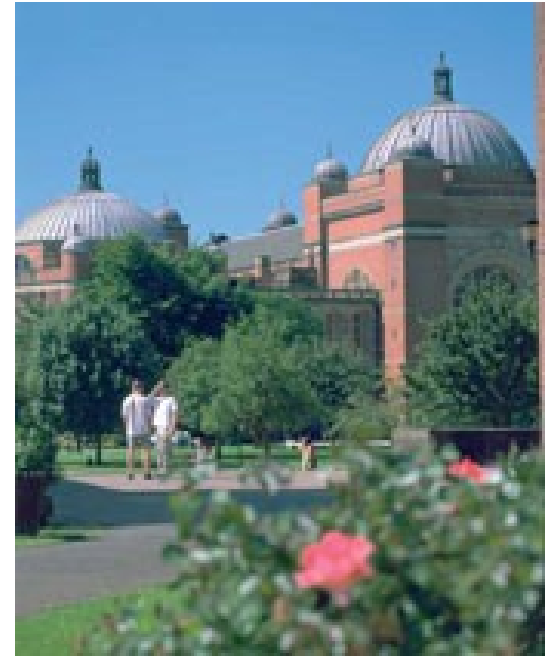

Experiments, experiments ...

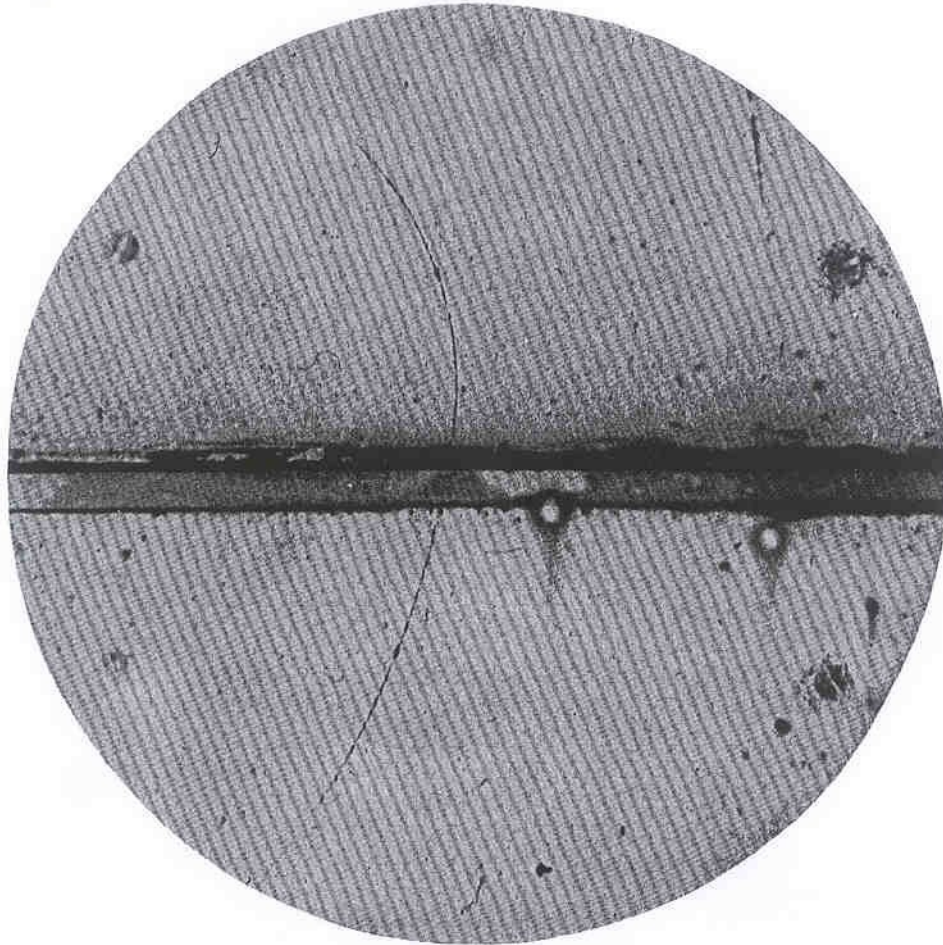

Discovery of positron

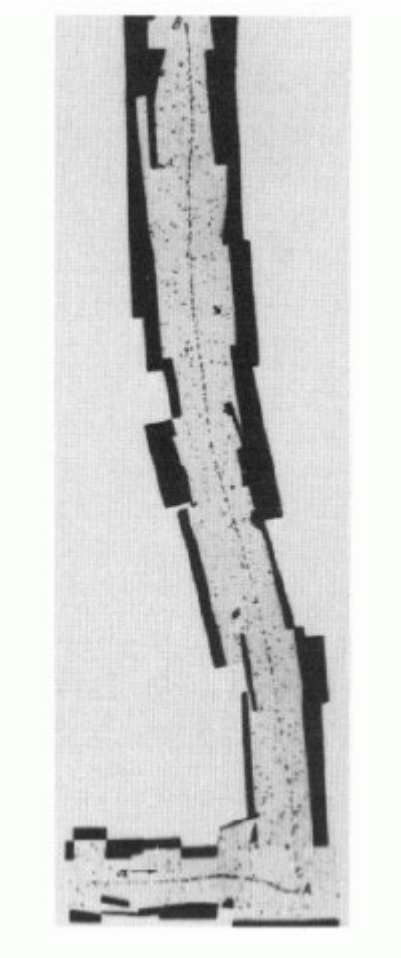

Decay of charged π

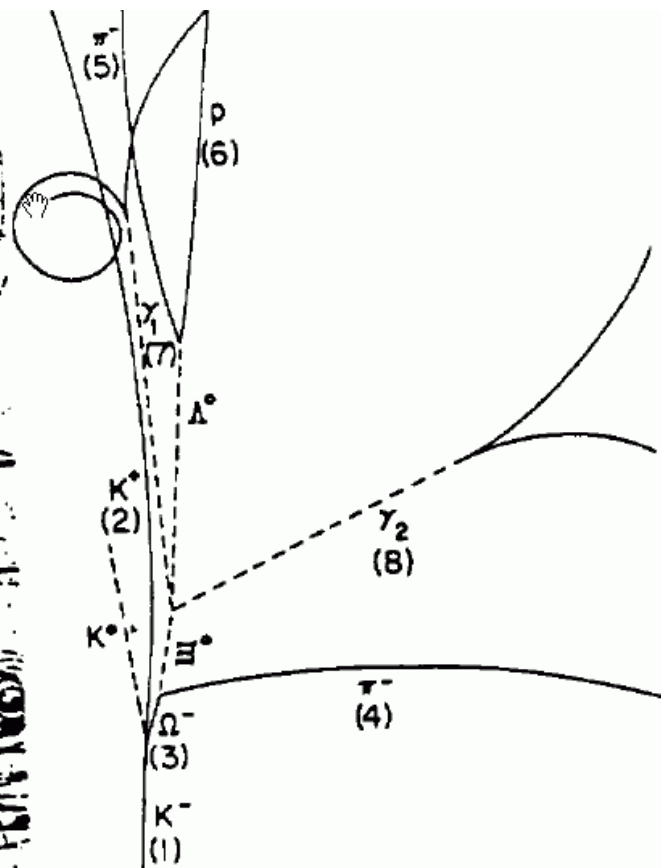
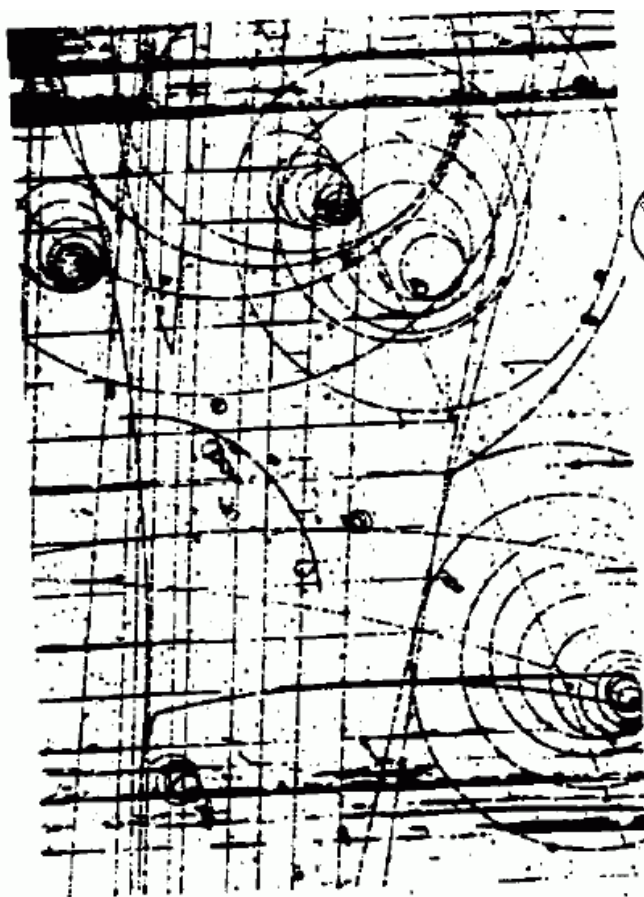

Discovery of Ω

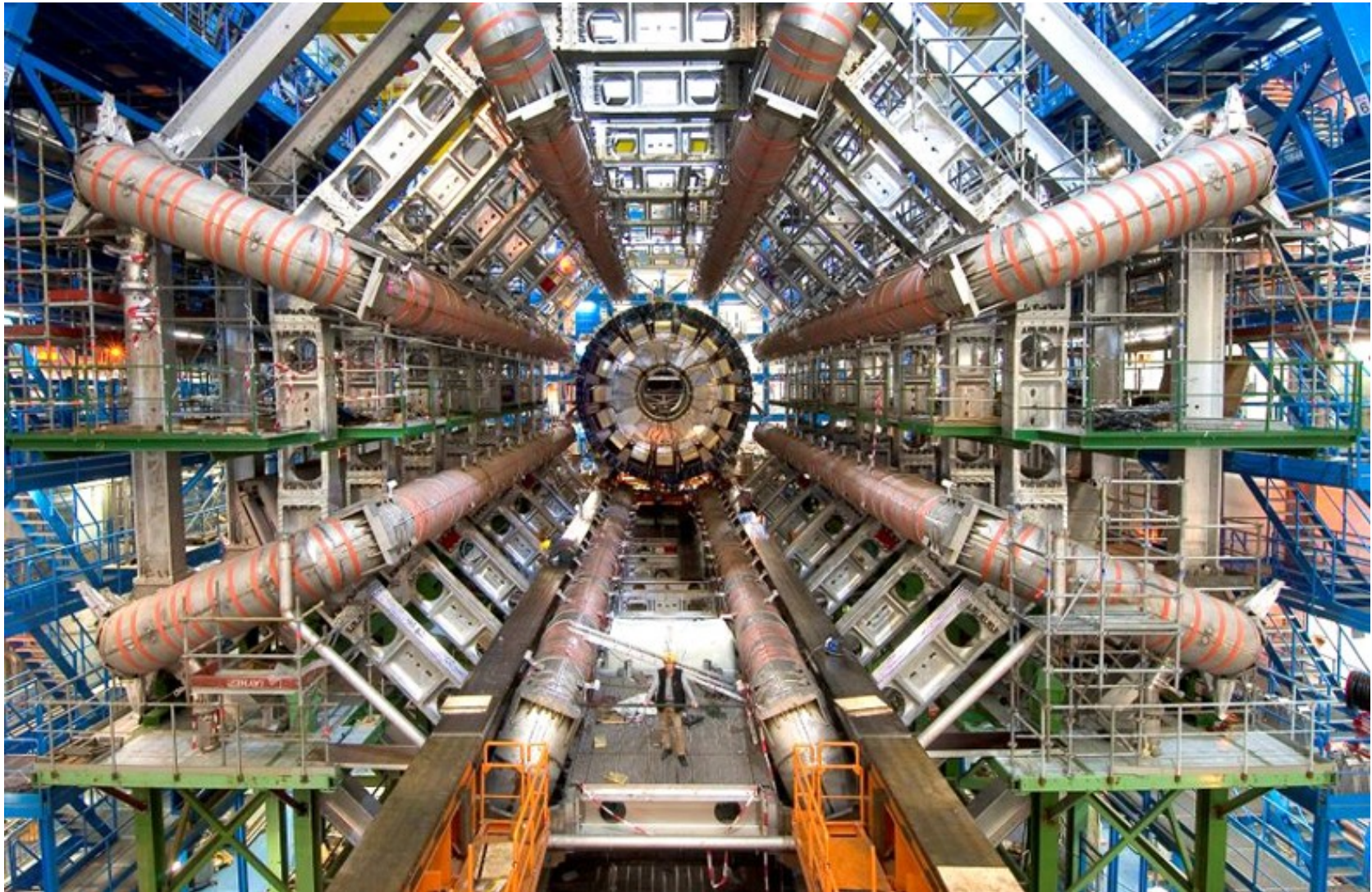

Higgs physics I

Known during design phase of ATLAS and CMS:

- ◆ Decay channels depend on mass:
 - ◆ $M_H < 130$ GeV
 - $b\bar{b}$ dominant
 - $\tau\tau$ subdominant
 - $\gamma\gamma$ Small but very clean
 - ◆ $M_H > 130$ GeV
 - WW dominant
 - ZZ large and clean

We were very lucky with
 $M_H = 125$ GeV!

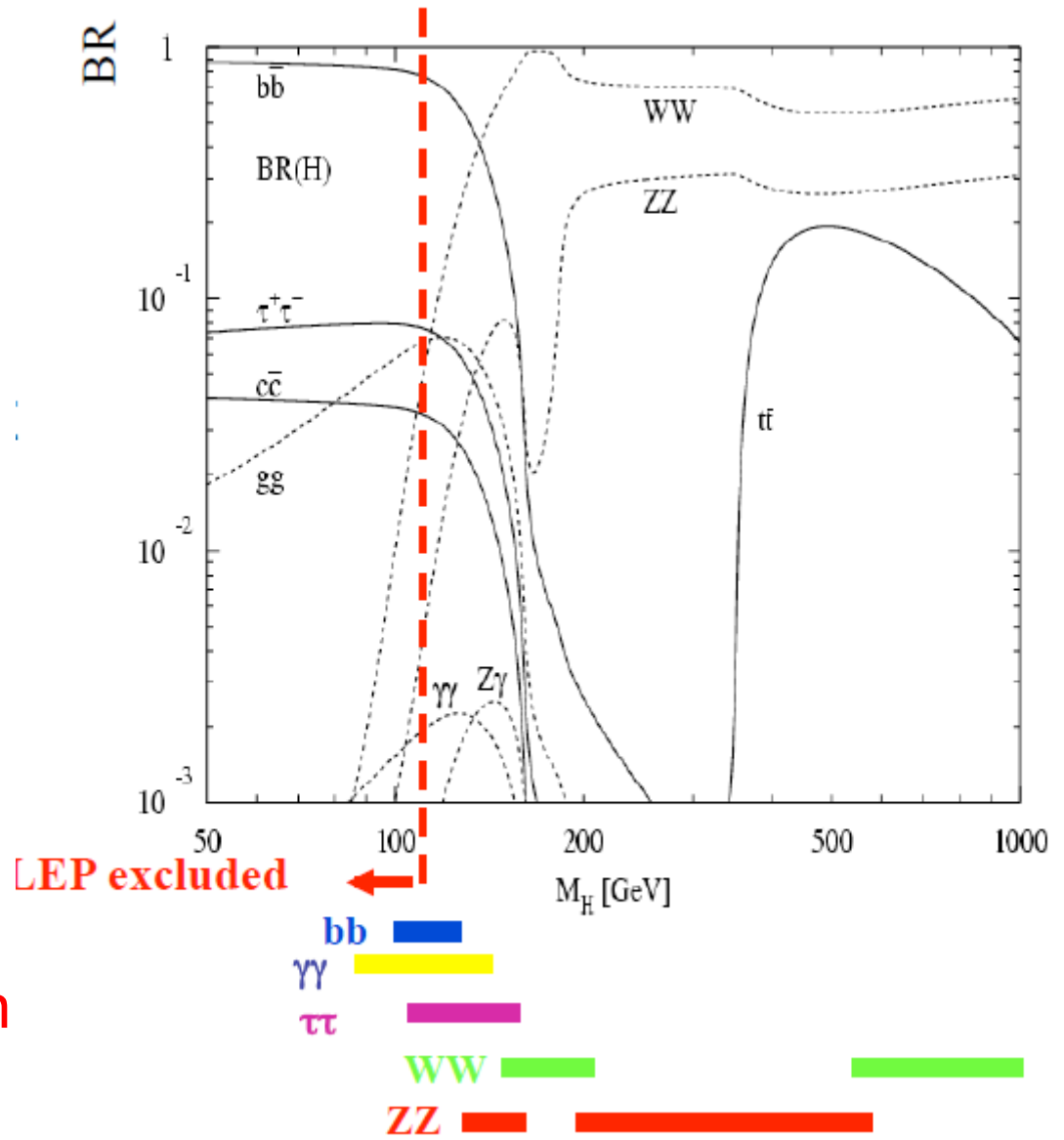

Higgs physics II

◆ Typical event rates at full luminosity:

→ Inelastic: 10^9 Hz

→ $W \rightarrow l\nu$: 10^2 Hz

→ SM Higgs (125 GeV): ~ 0.1 Hz

→ 1.5 % $H \rightarrow ZZ$

→ 0.2% $H \rightarrow \gamma\gamma$

Serious problem is to separate the signal from background! \Rightarrow need good detectors

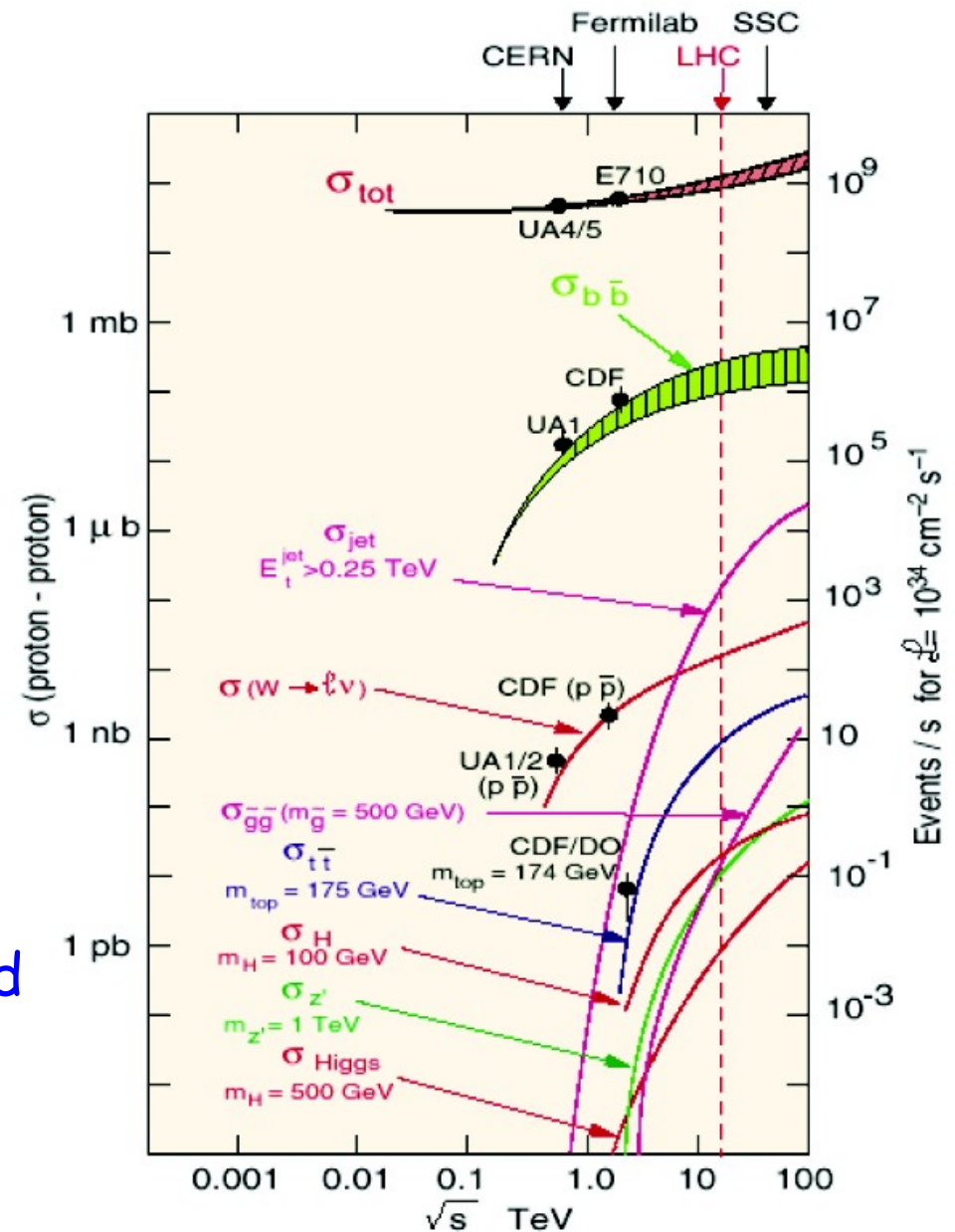

Higgs physics III - production

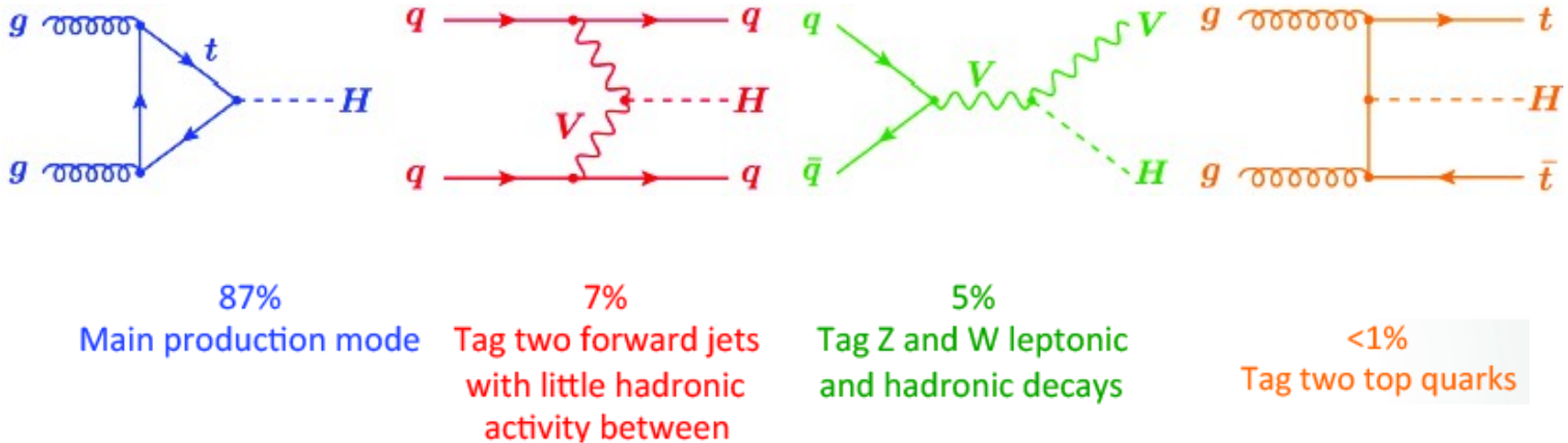

Need to separate dominant production mechanism from rare ones ...

Searches for supersymmetry

- ◆ Super-symmetric particles are produced in pairs
- ◆ Then decay in cascades
- ◆ Expect several high P_T jets
- ◆ Lightest SUSY particles escape - large missing E_T
- ◆ Possibly leptons

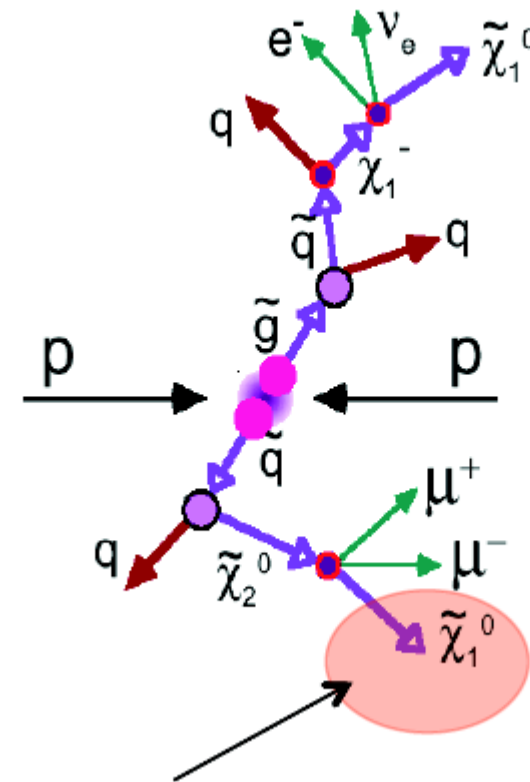

Dark matter!

Experimental signatures I

▶ Electrons:

- Lose energy by ionizing matter
- Bent in magnetic field
- Visible in tracking detectors
- At high enough energies (~ 10 MeV), radiate (bremsstrahlung), create EM shower
 - Narrow and well defined energy deposit
- Initiated, contained and measured in EM calorimeter

▶ Photons:

- Detected as an electron (EM shower) without a track
- Photons start to shower bit later, a finely segmented calorimeter can distinguish between them (but difficult)

Experimental signatures II

- ▶ Hadrons and jets
 - Most stable hadrons (p, n, π, K) initiate HAD showers in calorimeters
 - Penetrating farther (and are broader) than EM showers
 - Measured in HAD calorimeter
 - Usually combined with tracker information (for charged hadrons)
 - At high energies measure collimated groups of hadrons, "jets"
- ▶ Muons
 - Similar to electrons, but 200 times heavier
 - Ionize, but start to radiate at much larger energies (100s of GeV)
 - The only type of particle that is not absorbed in HAD calorimeter
 - Measure in large muon system outside calorimeters

Experimental signatures III

- ◆ τ (τ):
 - Decay into a muon (or electron) plus two neutrinos
 - Then detected in muon system
 - Also to one or three charged pions accompanied by neutral pions and neutrinos
 - Signature is then HAD shower with single or three isolated tracks pointing to it
- ◆ Heavy flavours:
 - Usually decay less than 1 mm from point of collision ("primary vertex")
 - Create "secondary vertex"
 - Identified with fine tracking detector located close to beam pipe (vertex detector)
- ◆ Missing energy:
 - Neutrinos escape detection, need to use transverse momentum conservation (detectors are too small!)
 - Total transverse momentum should be zero, measure it from all detected particles
 - Large missing momentum (MET) is sign that something escaped

What do we want to measure???

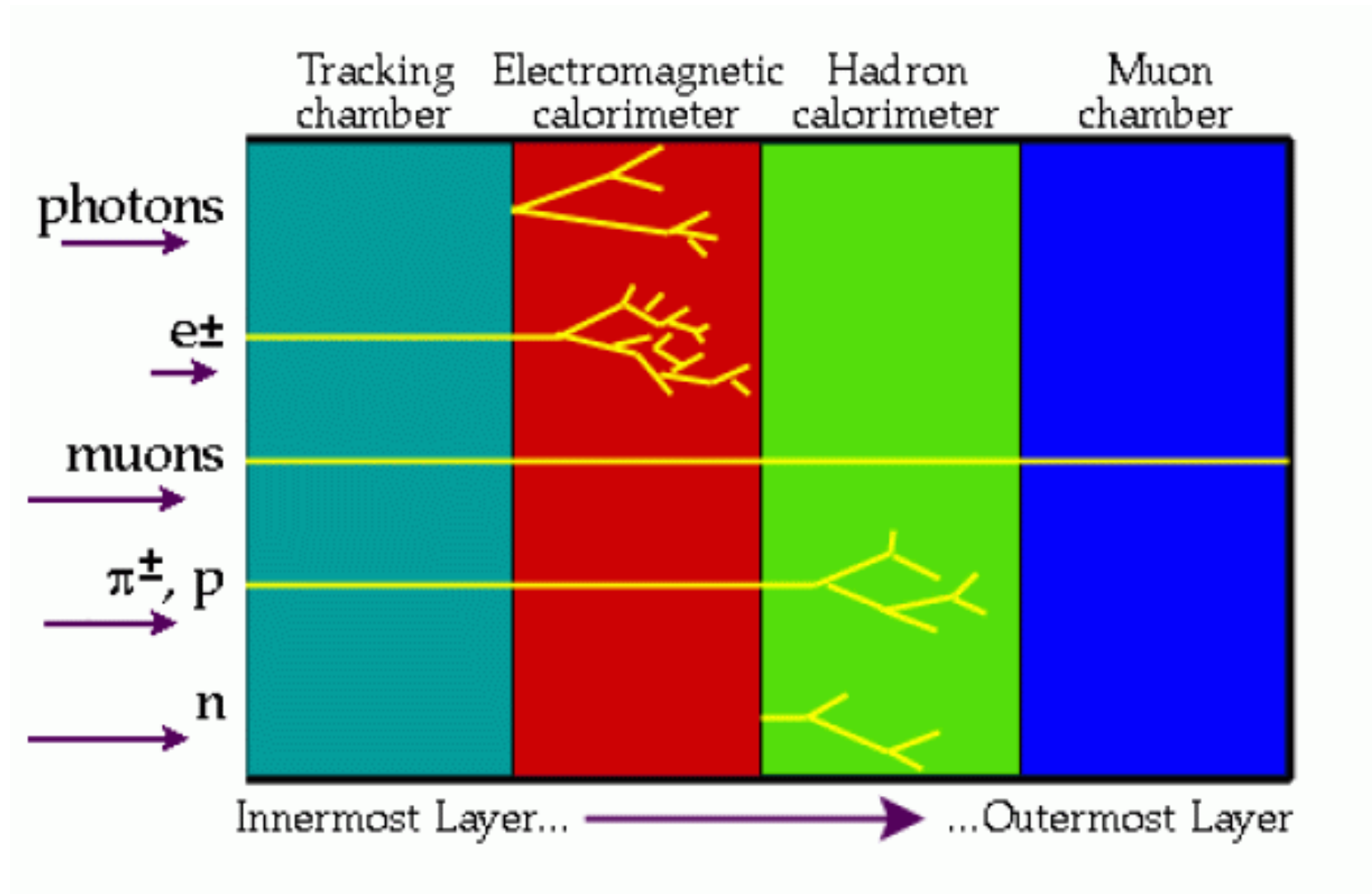

What do we want to measure???

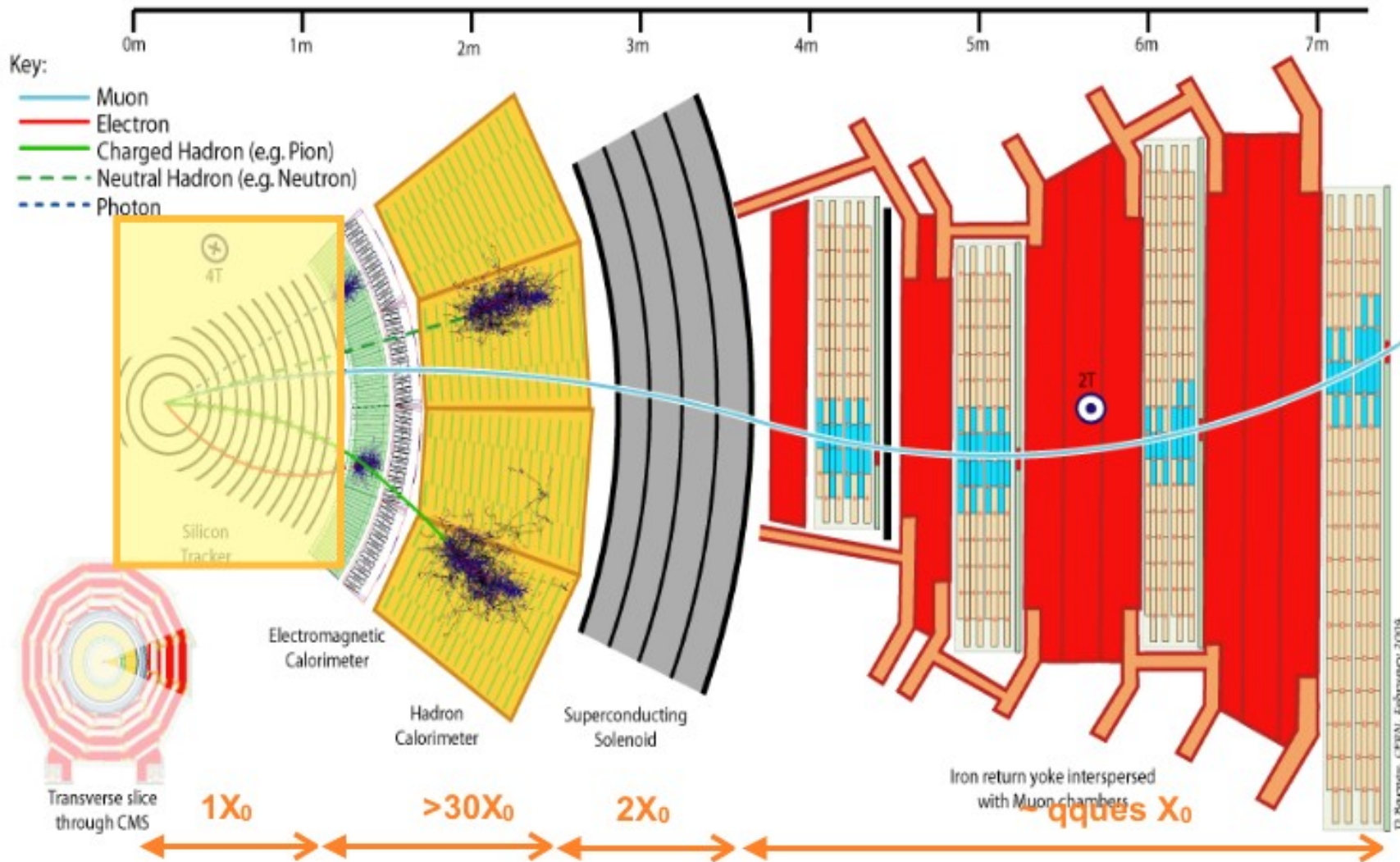

Generic high P_T collider detector

Kinematic coverage I

Rapidity coverage:

$$y = \frac{1}{2} \log \left(\frac{E + p_L}{E - p_L} \right)$$

Two partons with x_1, x_2 form particle with mass M :

$$x_1 = \left[\frac{M}{\sqrt{s}} \right] \exp(y_M)$$

$$x_2 = \left[\frac{M}{\sqrt{s}} \right] \exp(-y_M)$$

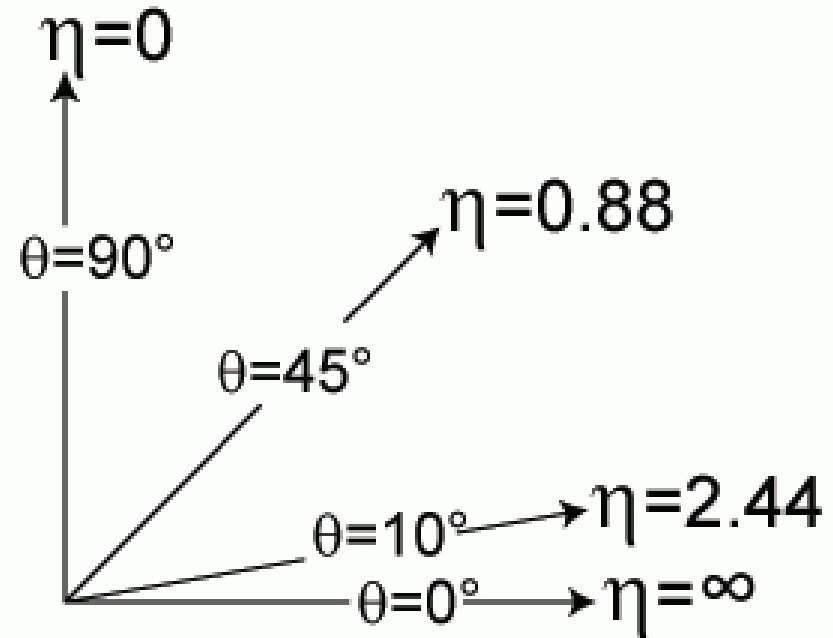

Assuming x_1 close to 1:

$$y_{max} \rightarrow \log \left(\frac{\sqrt{s}}{M} \right)$$

With LHC energy of ~ 7 TeV :

- $y_{max} \sim 5$ for pions - total coverage
- $y_{max} \sim 2$ for Z's - precision (barrel) area

Kinematic coverage II

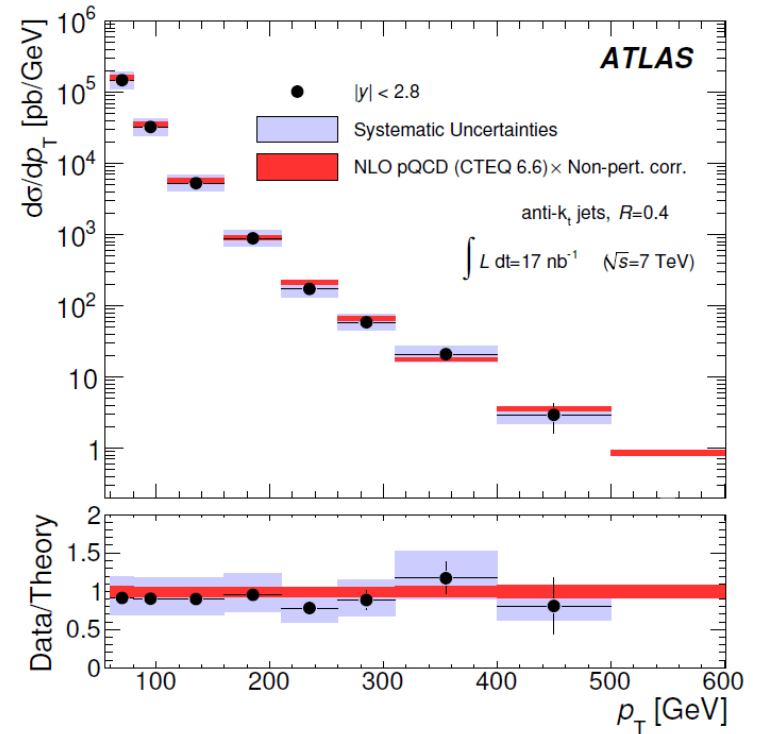
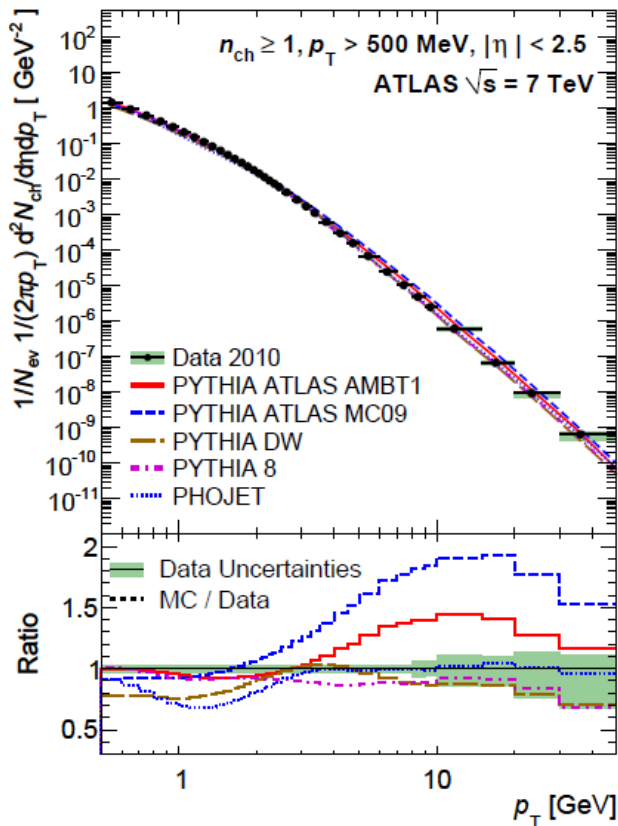

P_T coverage:

- ◆ Most of particles rather small P_T (below 1 GeV)
- ◆ Want also jets with 100s of GeV
- ◆ And several TeV electrons ...

Tracking I

From geometry (small θ):

$$\frac{L/2}{\rho} = \sin\left(\frac{\theta}{2}\right) \approx \frac{\theta}{2}$$

$$S = \rho(1 - \cos\frac{\theta}{2}) \approx \rho \frac{\theta^2}{8}$$

From deflection in magnetic field:

$$p_T = 0.3 B \rho$$

$$\theta = \frac{L}{\rho} = \frac{0.3 BL}{p_T} \Rightarrow S = \frac{0.3}{8} \frac{L^2 B}{p_T} \Rightarrow \frac{\sigma(p_T)}{p_T} = \frac{\sigma(S)}{S}$$

We measure sagitta from three spatial points:

$$S = x_2 - \frac{x_1 + x_3}{2} \Rightarrow \sigma^2(S) = \frac{3}{2} \sigma^2(x) \quad \frac{\sigma(p_T)}{p_T} = \frac{\sigma(S)}{S} = \sqrt{\frac{3}{2}} \sigma_X \frac{8 p_T}{0.3 BL^2}$$

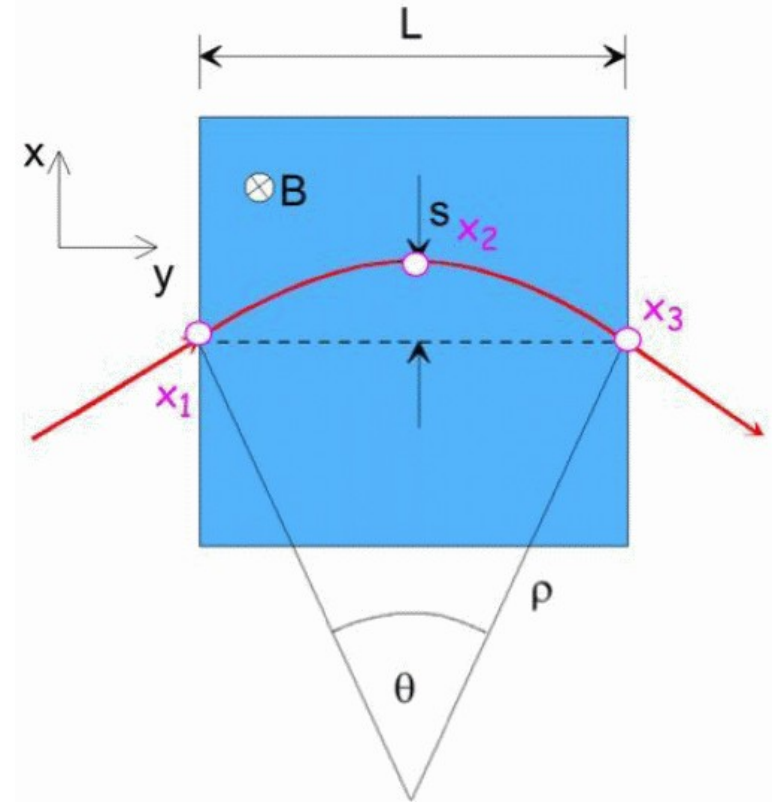

Tracking II

Magnetic field is along the beam axis

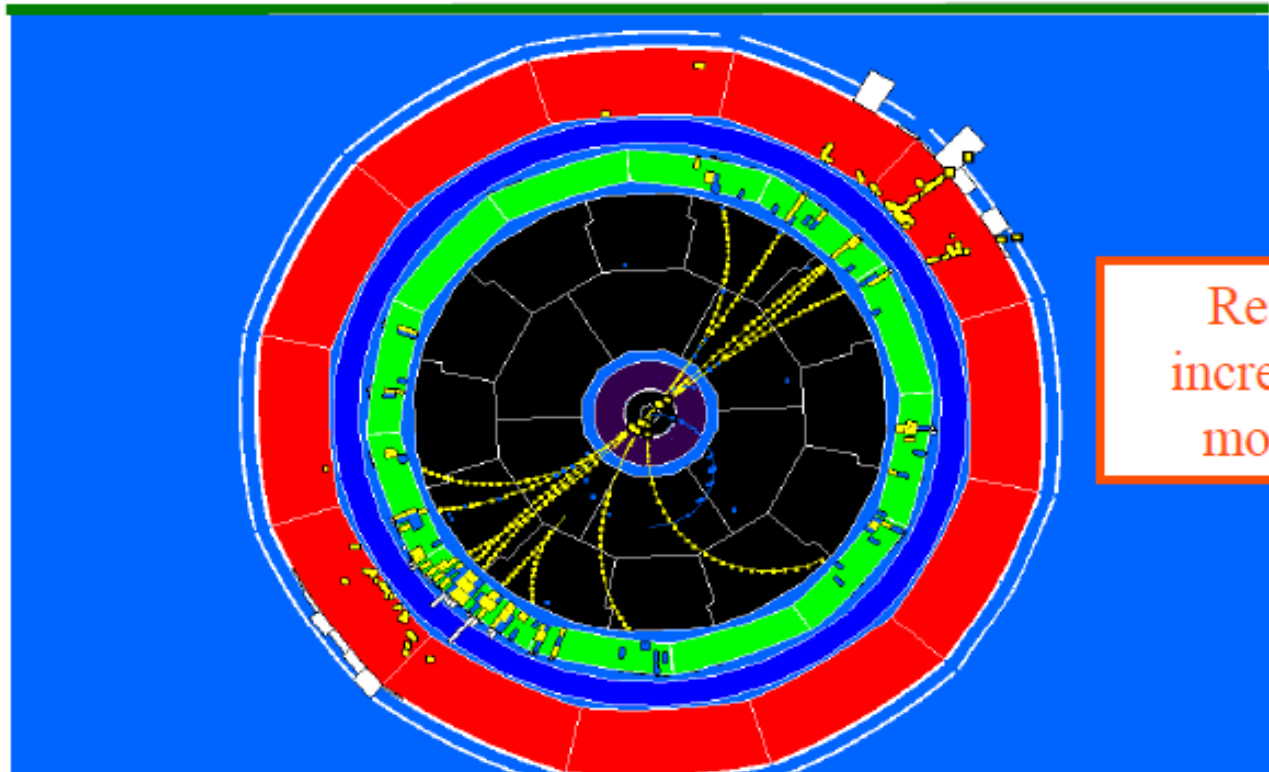
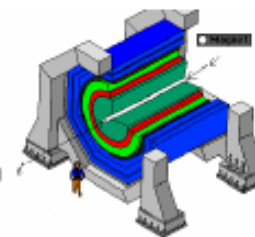

Resolution
increases with
momentum

$$\frac{\Delta p}{p} \approx 0.25 \left(\frac{\Delta s}{100 \mu m} \right)^1 \left(\frac{1 m}{L} \right)^2 \left(\frac{1 T}{B} \right)^1 \left(\frac{p}{100 GeV} \right)$$

Gigi Rolandi : Summer Student Lecture 08 July 2005

Tracking III

- ▶ Measure momentum of particles from curvature
- ▶ At the same time particles should lose as little energy as possible (to allow further measurements)
- ▶ Momentum resolution depends on position resolution, magnetic field and size of the tracker (NIM 24 (1963) 381):

$$\frac{\delta P_T}{P_T} = \sqrt{\frac{720}{N+4} \frac{P_T \sigma}{0.3 BL^2}} [GeV, T, m]$$

- ▶ To measure momentum of 1TeV particle (for example from WW scattering) with 10% precision, assuming position resolution of $\sigma=100 \mu\text{m}$ one needs $BL^2 \sim 3 \text{ Tm}^2$
- ▶ To get 1% would mean 30 Tm^2

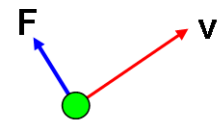

Fig. 1

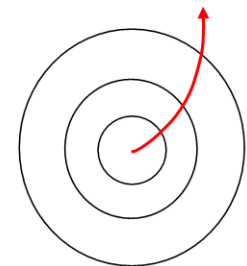

Fig. 2

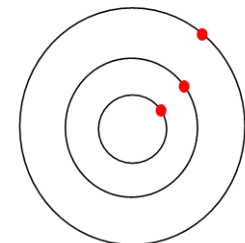

Fig. 3

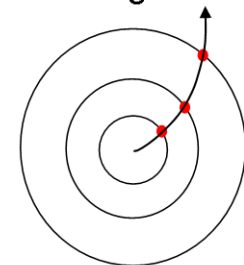
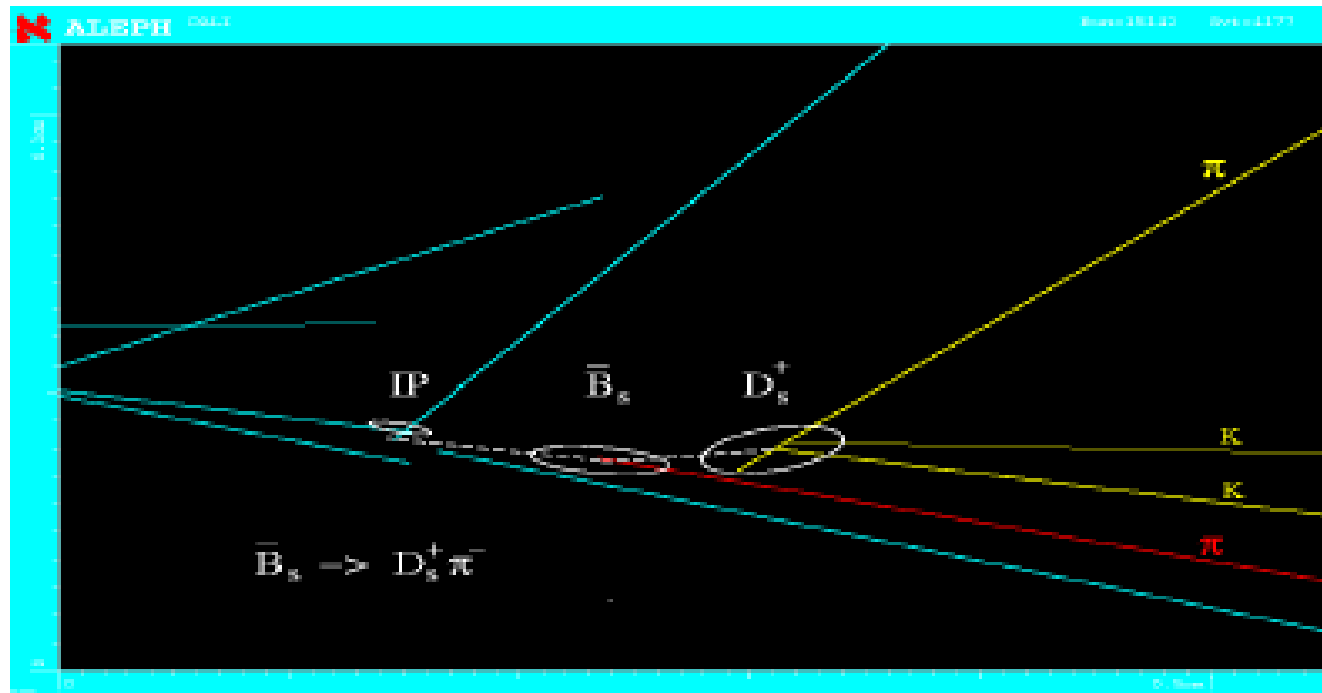

Fig. 4

Heavy Flavour tagging



- Used to find and identify the secondary decay vertices of heavy quarks and leptons
- Typical lifetimes:
- $(c\tau)_\tau \sim 87 \mu\text{m}$
- $(c\tau)_b \sim 475 \mu\text{m}$
- $(c\tau)_c \sim 100 \mu\text{m}$ (D^0)

Vertex detector

- Need resolution of the order of $100\ \mu\text{m}$
- The subsystem at the smallest transverse radius, in hardest radiation region
- Don't need large areas or big volumes, can use silicon pixels

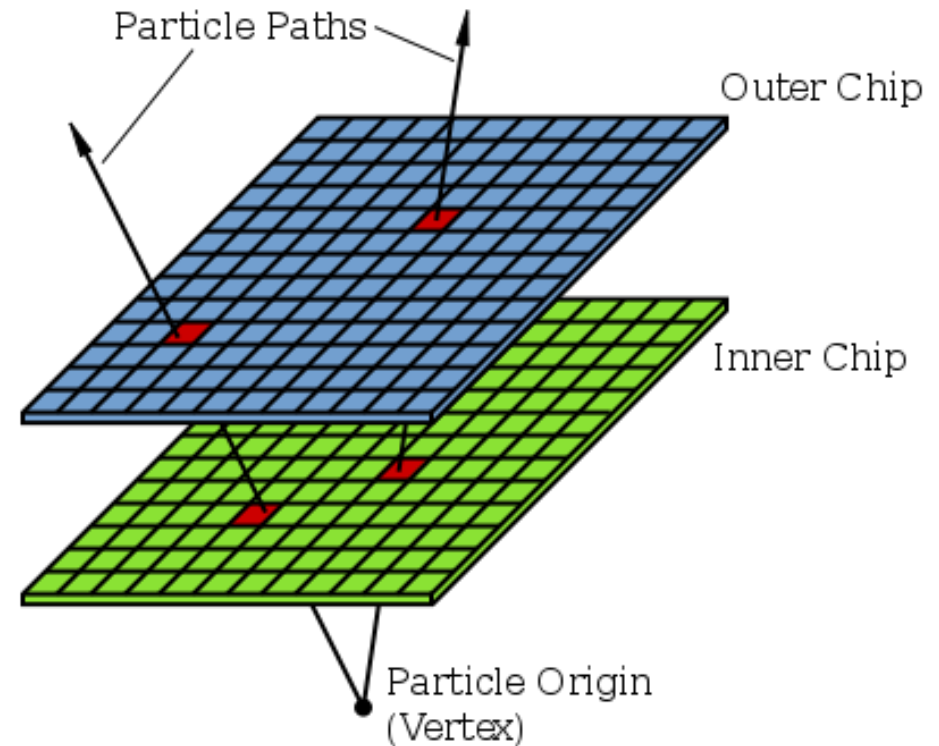

EM Calorimetry I

- ◆ The length of the shower increases with the logarithm of energy
- ◆ The transversal size doesn't depend on energy (90% in 2-3 cm)

Massive shower in a tungsten cylinder (outlined in green) produced by a single 10 GeV incident electron.

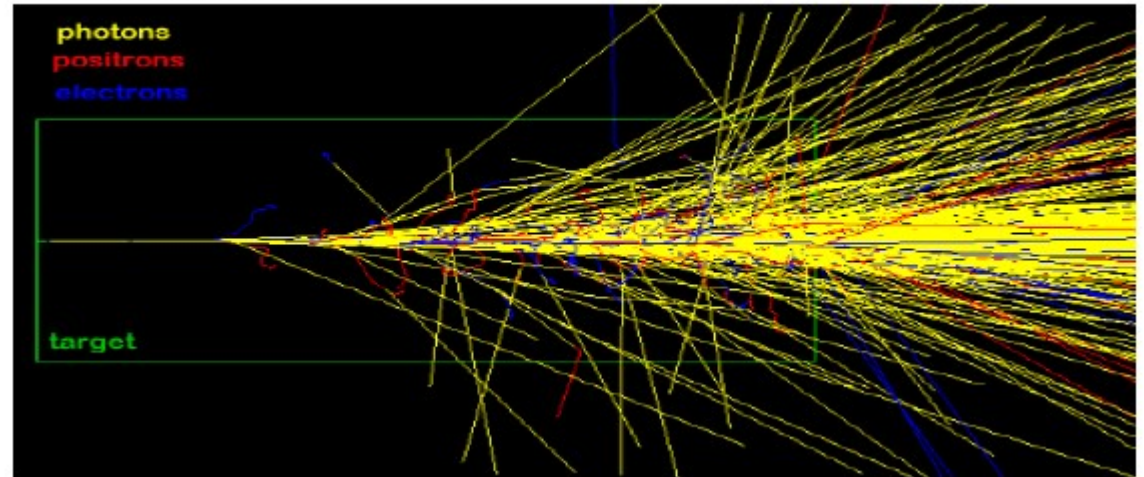

- ◆ Used to identify electron and photons and to measure their energy

→ $(X_0)_{Pb} = 0.56 \text{ cm}$

→ $(\lambda_0)_{Pb} = 16.8 \text{ cm}$

Shower profiles

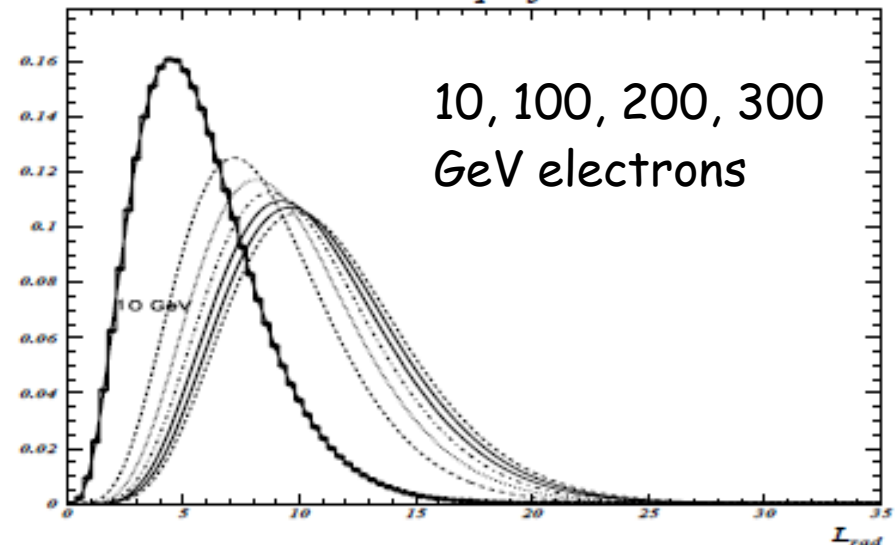

EM Calorimetry II

- ▶ Calorimeters - the only type of detector with (relative) resolution improving with energy!
- ▶ Important for EM energy measurement
- ▶ Also need good e and γ identification
- ▶ Typical (necessary) resolution:
 - $M_Z = 91.2 \text{ GeV}$
 - $\Gamma_Z = 2.5 \text{ GeV}$
 - Need resolution at least 1% for electrons from Z

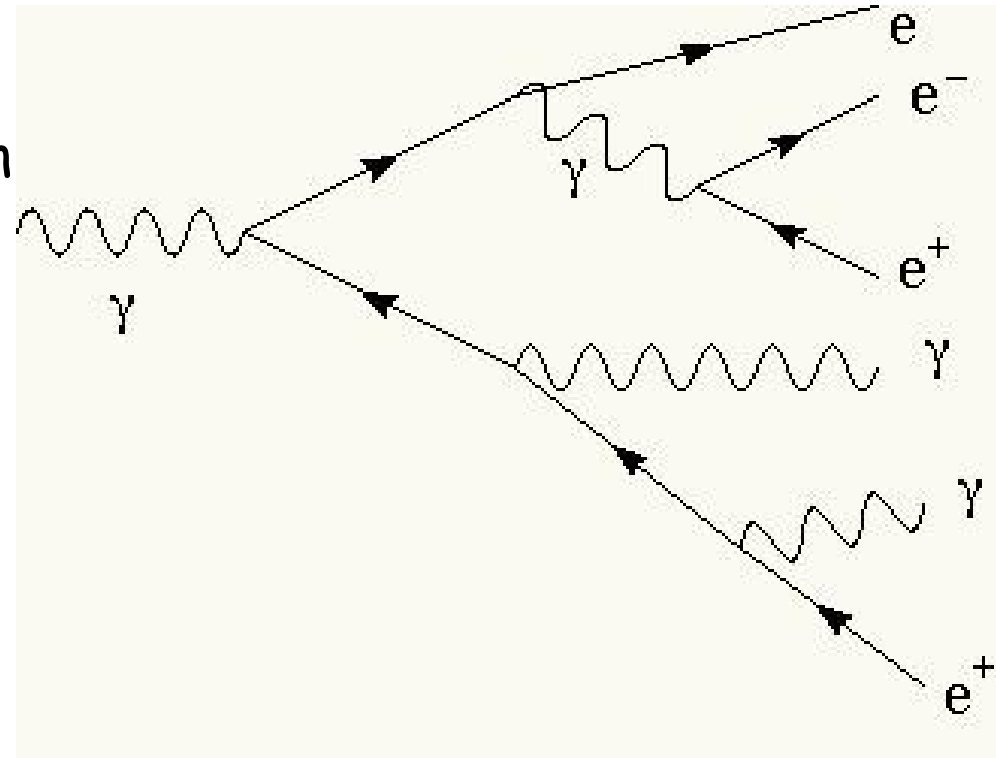

$$\frac{\sigma(E)}{E} = a \oplus \frac{b}{\sqrt{E}}$$

HAD Calorimetry I

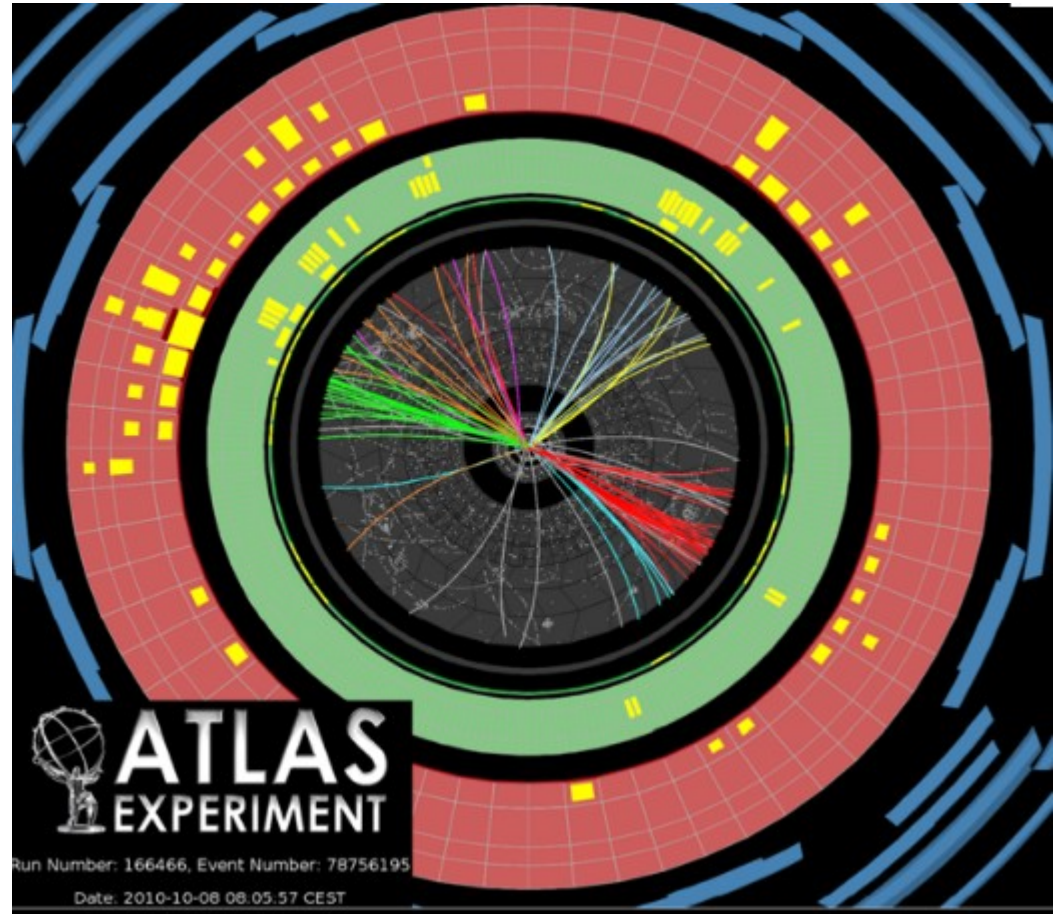
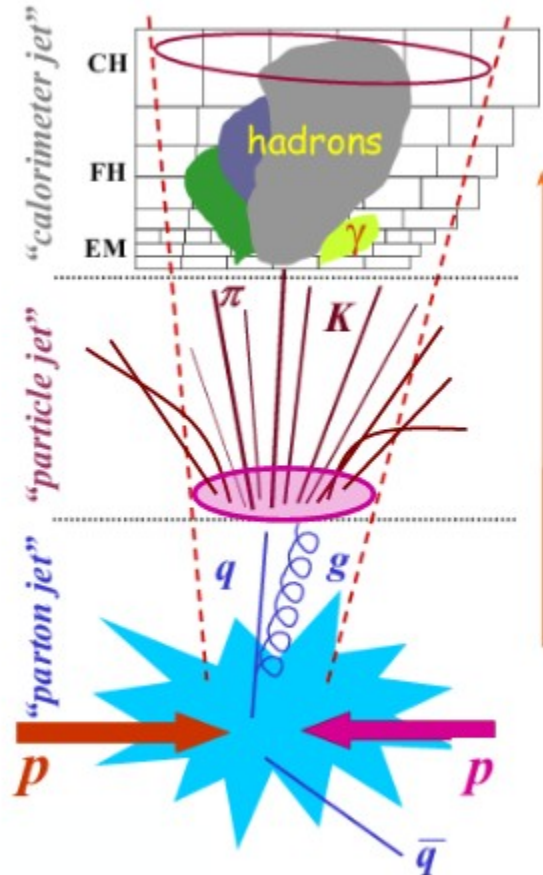

HAD Calorimetry II

- ◆ Measure energy of produced hadrons and jets coming from hadronization of quarks and gluons
- ◆ Hermetic calorimetry - measure energy of all produced particles within range of $|\eta| < 5$
- ◆ Needed to measure missing E_T
- ◆ Would be nice to have sufficient resolution to measure W width
- ◆ $\Gamma_W / M_W = 2.6 \%$, need $dE/E \sim 1\%$
- ◆ Not that easy, at least get close to it ...

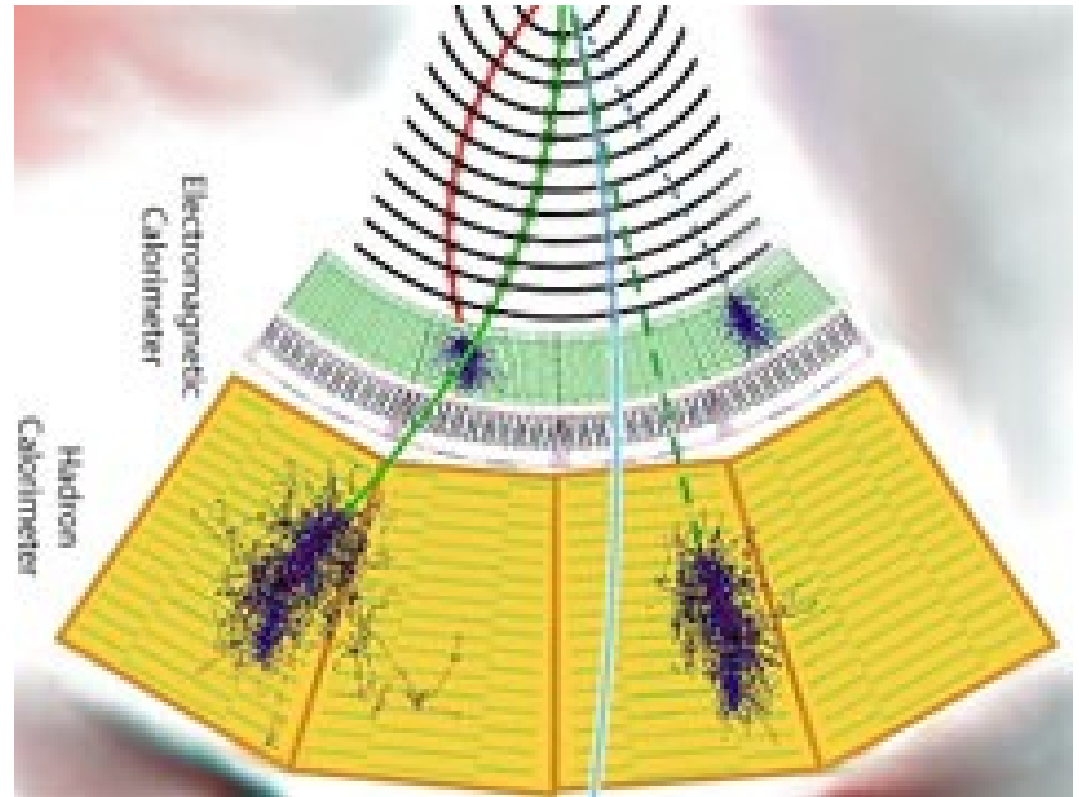

Muon system

- ▶ Particles that penetrate through HCAL are all muons - minimum ionizing particles up to 100s of GeV
- ▶ Clean, robust and unambiguous signature of much of LHC physics
- ▶ Would like to measure for example $H \rightarrow ZZ \rightarrow 4\mu$ with 1% momentum resolution
- ▶ At high energies, 1TeV muons with resolution better than 10%

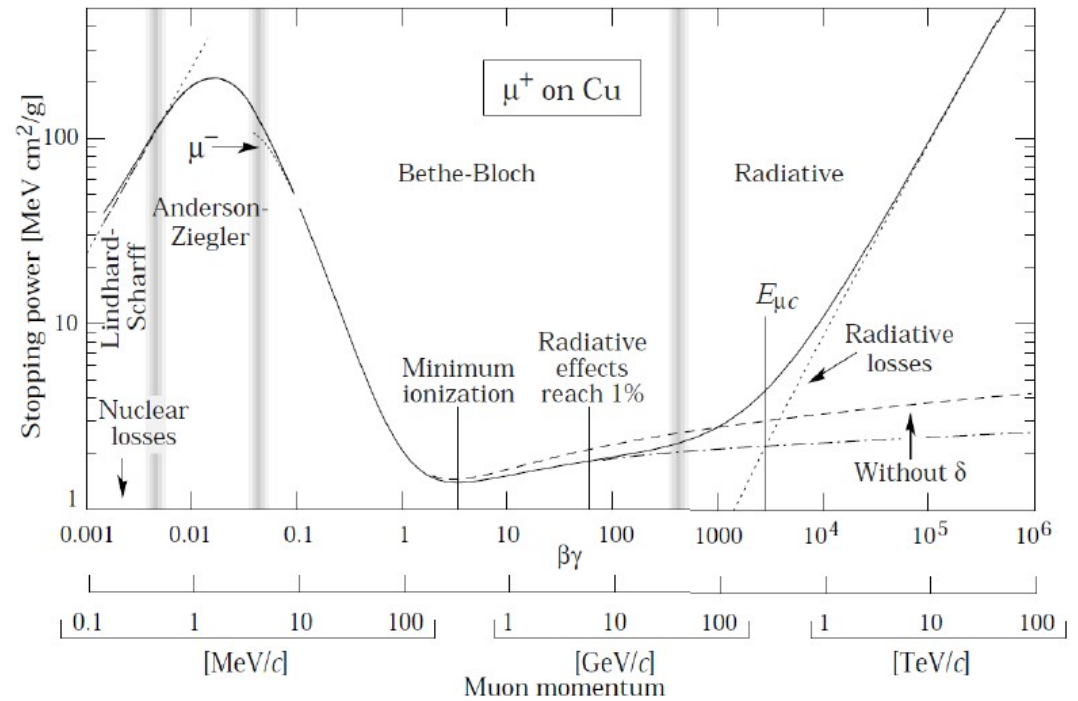

Trigger

- ◆ At full LHC luminosity, huge event rate
 - ➔ Each bunch crossing results in ~ 25 (or ~ 50) inelastic collisions
- ◆ Event size typically 1-2 MB
- ◆ Bottle neck is archival storage and processing capability, possible data rates are 200-300 MB/s (corresponding to ~ 100 Hz, 1kHz for Run2)
 - ➔ Need online filter (trigger) deciding which events should be saved on disk

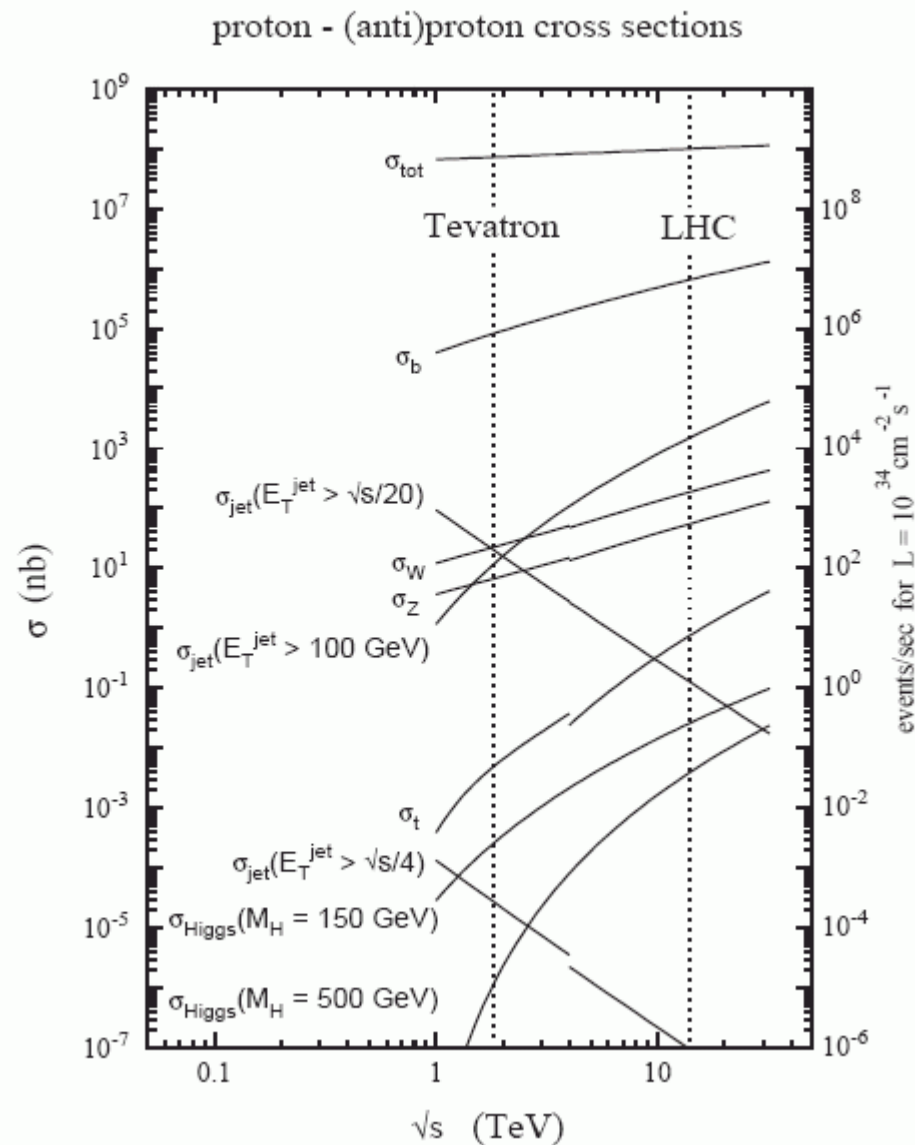

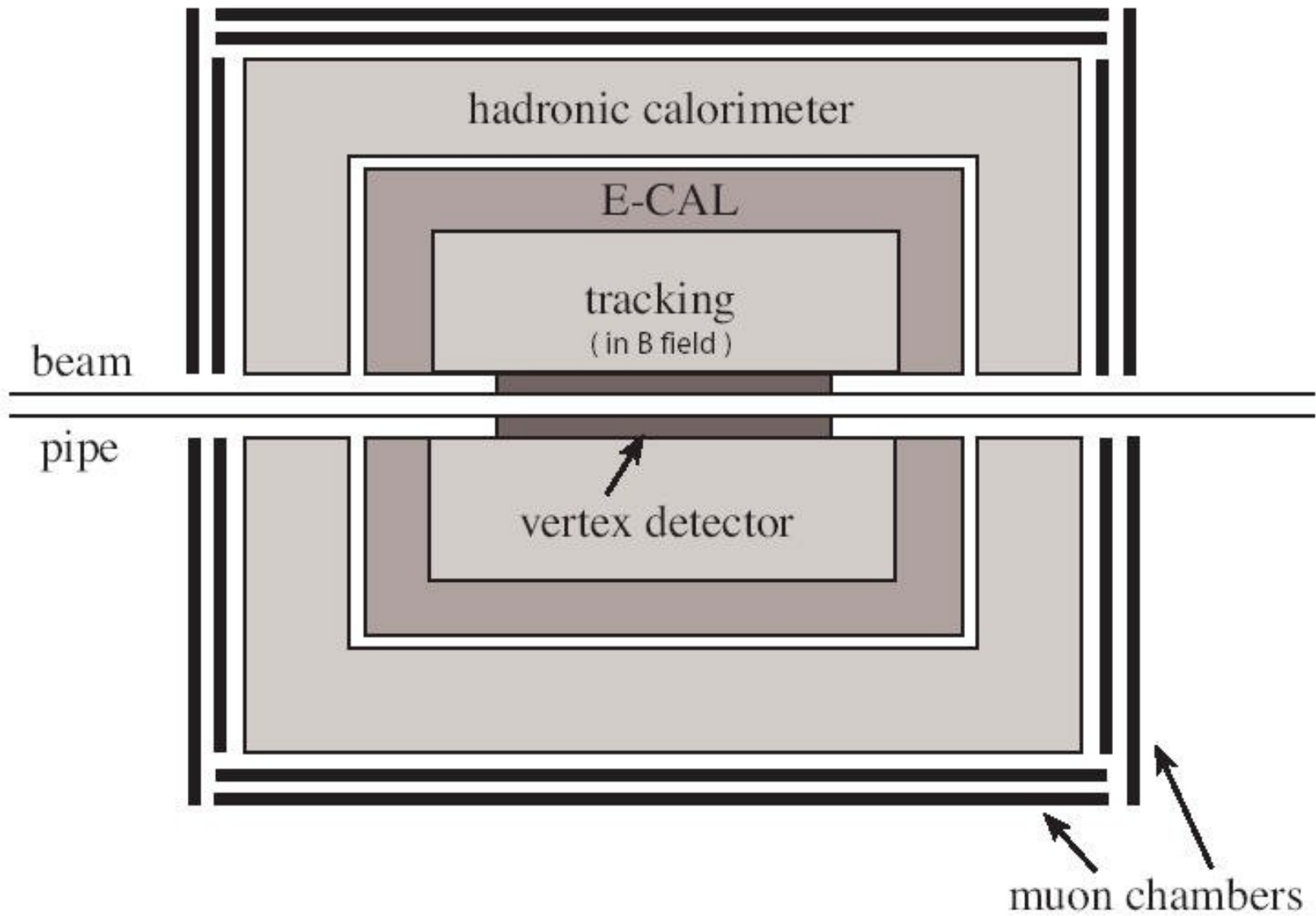

ATLAS and CMS, the same physics, different approaches

The same physics, very different detectors

A Toroidal LHC Apparatus

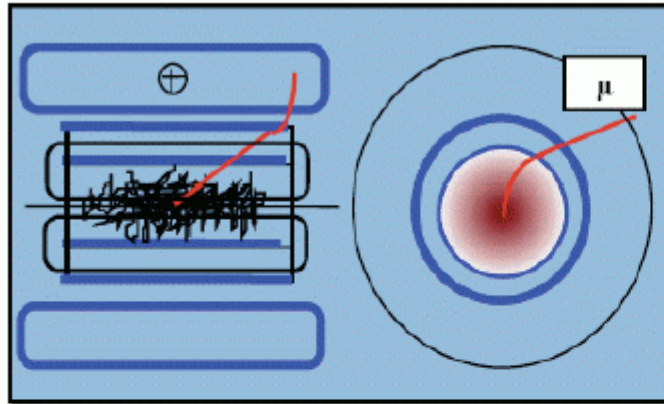

Compact Muon Solenoid

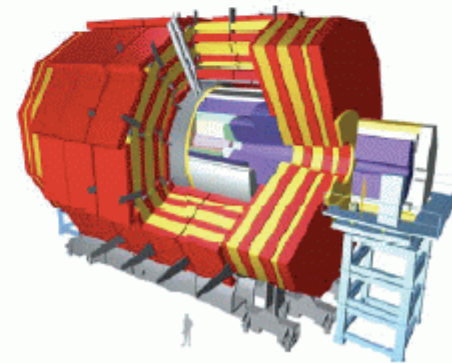
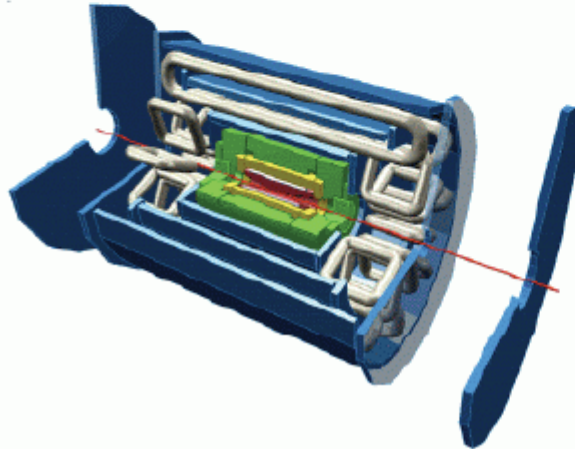
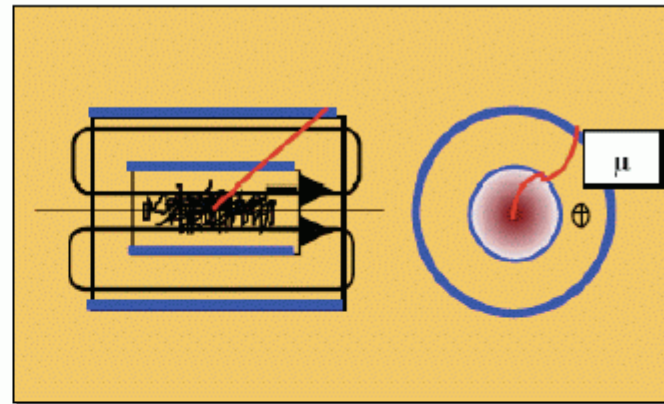

$$\frac{\Delta p}{p} = K \frac{1}{B L^2}$$

How to choose the magnet?

Magnetic field - CMS approach

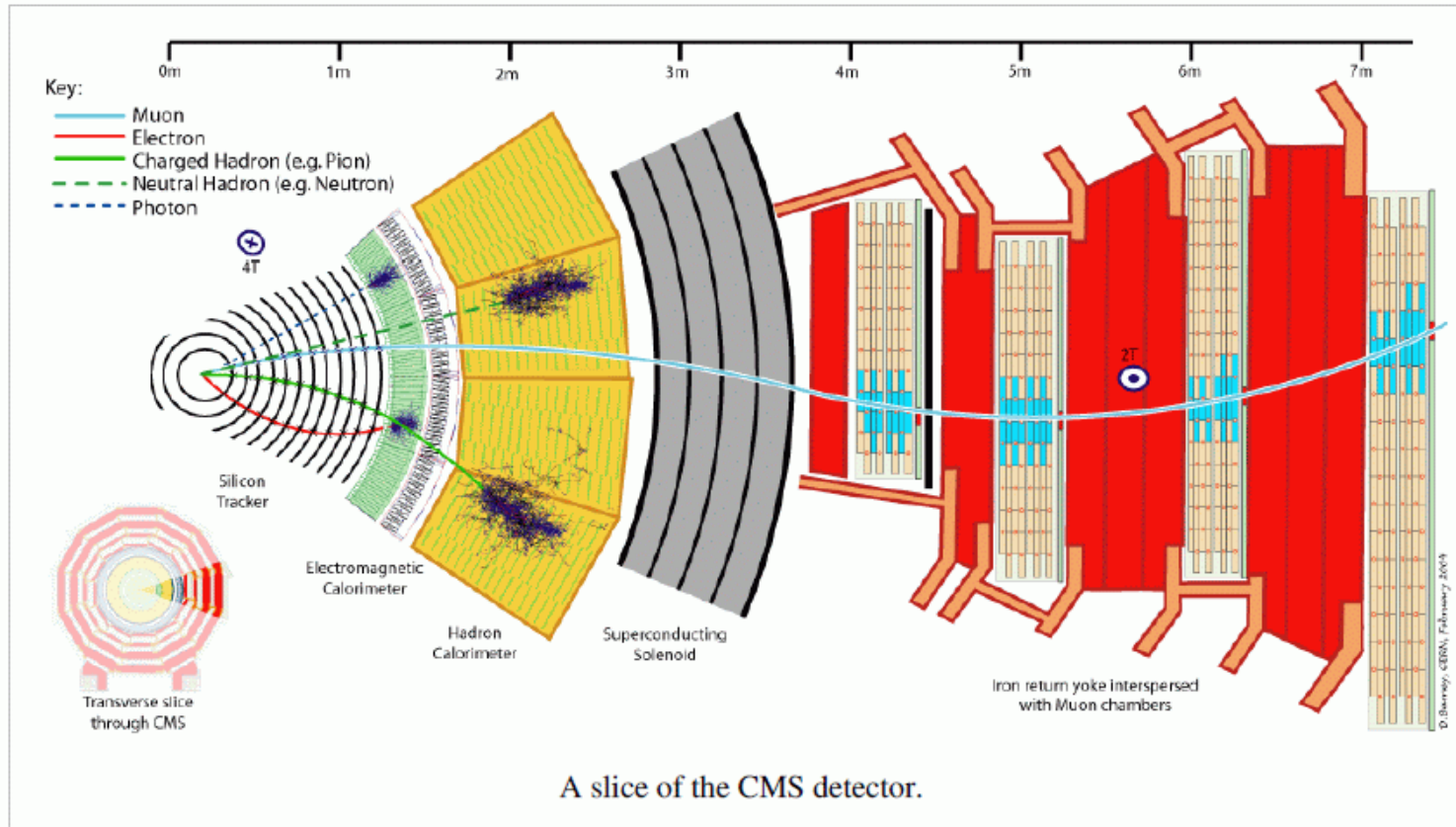

Very high solenoidal field in (relatively) small volume !

- ◆ $L=3\text{m}$ in 4T bending field, $BL^2=36\text{ Tm}^2$
- ◆ Another bending from return flux (another 5 Tm^2)
- ◆ Tracks of charged particles have characteristic S-shape

Magnetic field - ATLAS approach

- ▶ Central solenoid: $L=1\text{m}$ in 2T bending field, $BL^2=2\text{ Tm}^2$
- ▶ Outside of the solenoid are large air-core toroids with bending field of 1T over a distance of $\sim 6\text{m}$, $BL^2=36\text{ Tm}^2$
- ▶ Additional end-cap toroid in forward and backward direction
- ▶ Similar bending power then in CMS, but in much larger volume

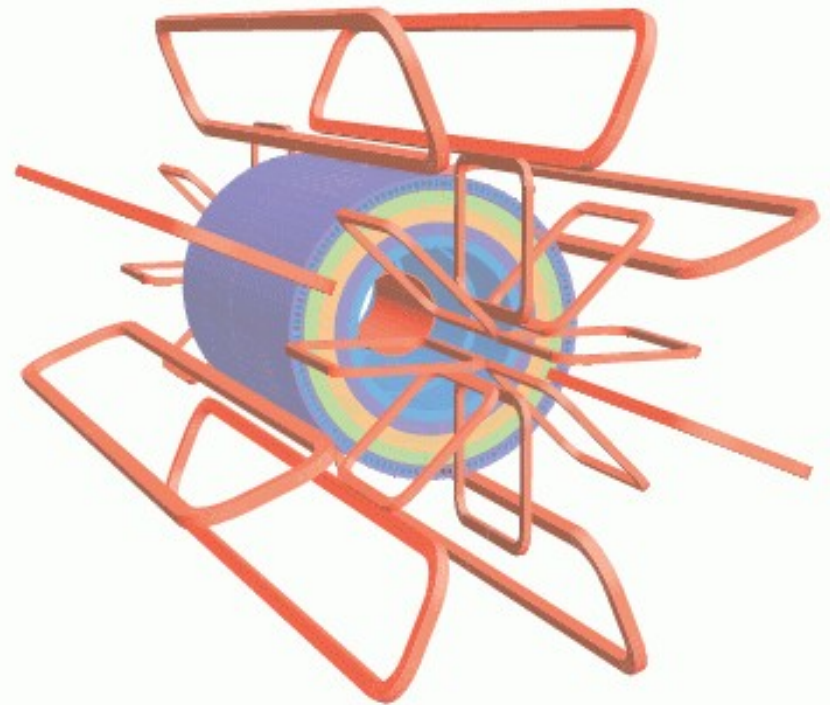

Superconducting magnet - CMS

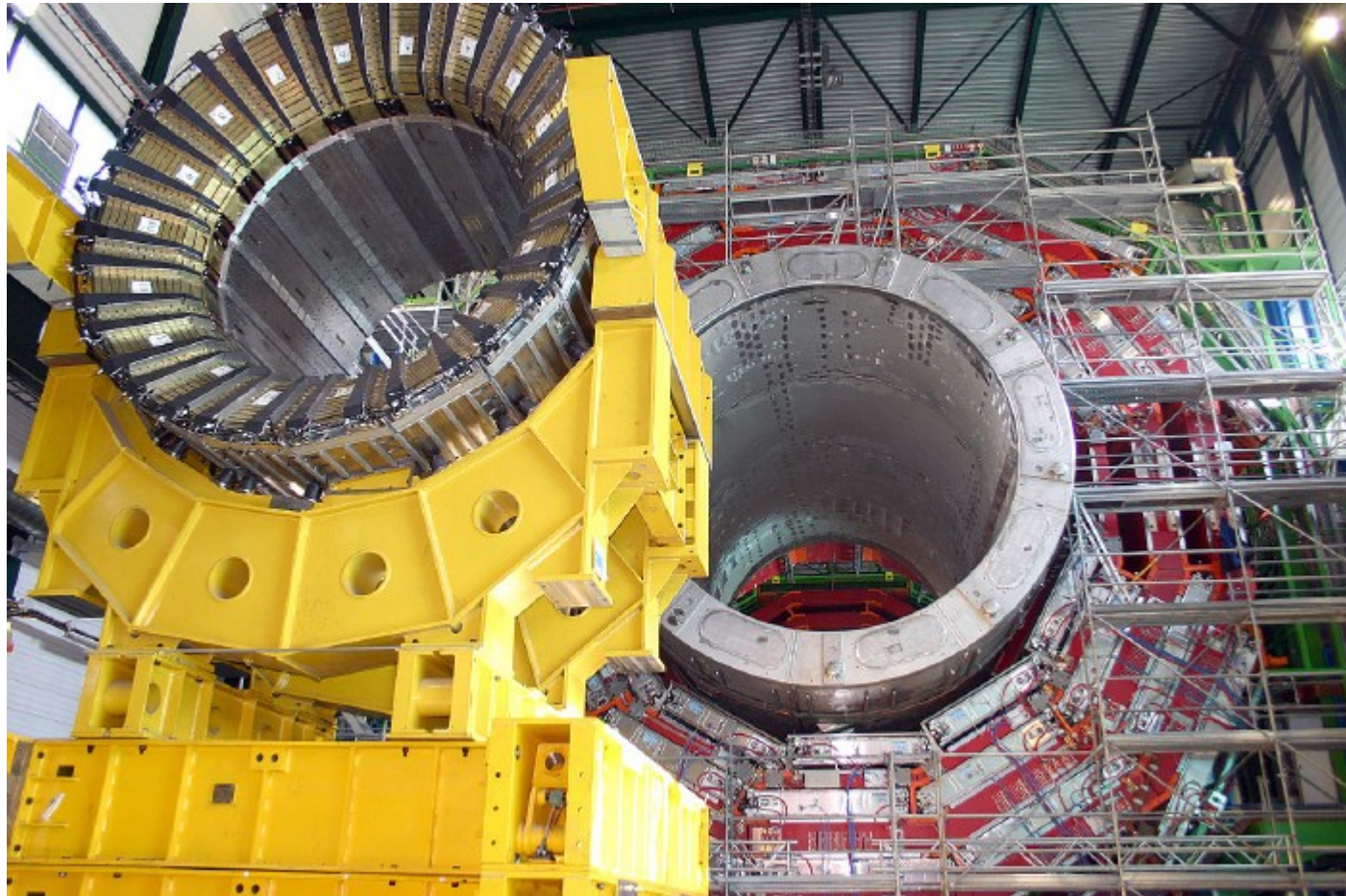

Superconducting magnets - CMS

- ▶ CMS solenoid has unusually large ratio between stored energy and cold mass (11.6 KJ/kg)
- ▶ Large mechanical deformation and stress
- ▶ 4T field in space of 6m (diameter) x 12.5 m (length)
- ▶ Stored energy of 2.6 GJ at full current
- ▶ Four layer winding made from NbTi superconductor, stabilized and reinforced by Al alloy

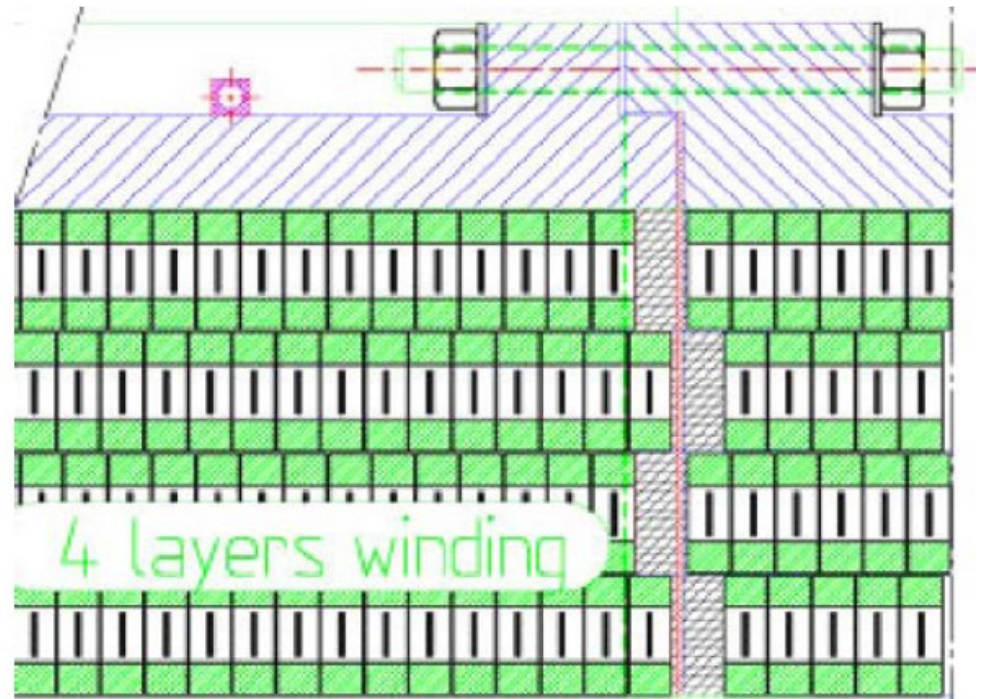

Superconducting magnets - ATLAS

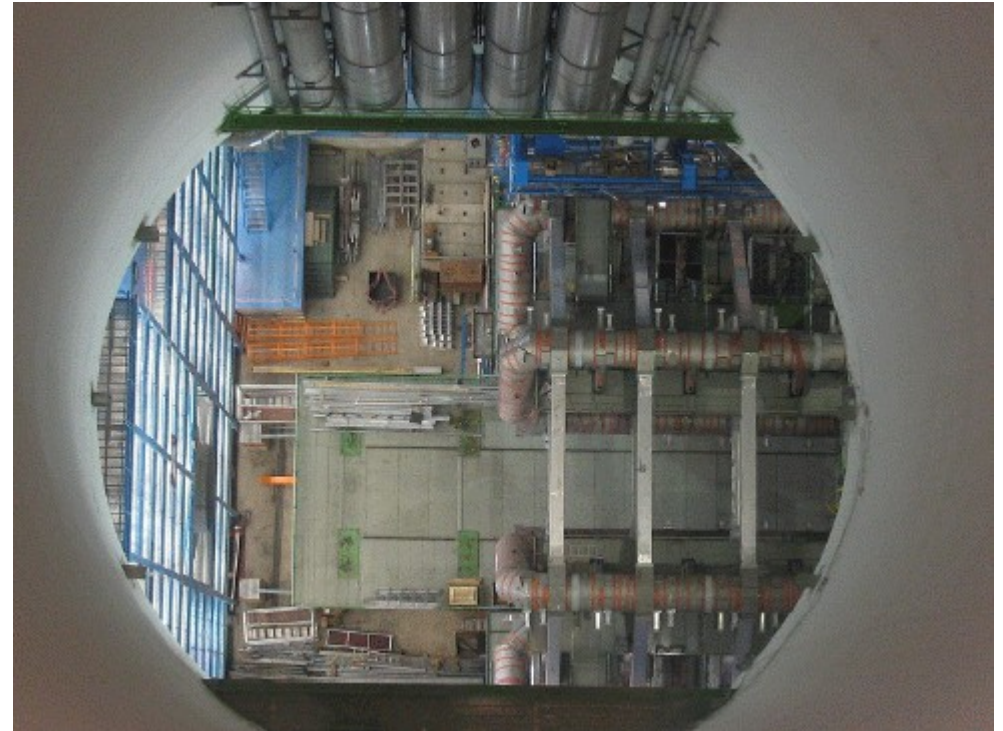

Calorimetry - CMS EMCAL

- ◆ Very compact, high resolution design
- ◆ Scintillating PbWO_4 crystals
 - Excellent resolution
 - Homogeneous
 - Low light yield
 - Sensitive to temperature variations
- ◆ Light read-out using silicon avalanche photodiodes (barrel) and vacuum phototriodes (VPTs) in endcaps

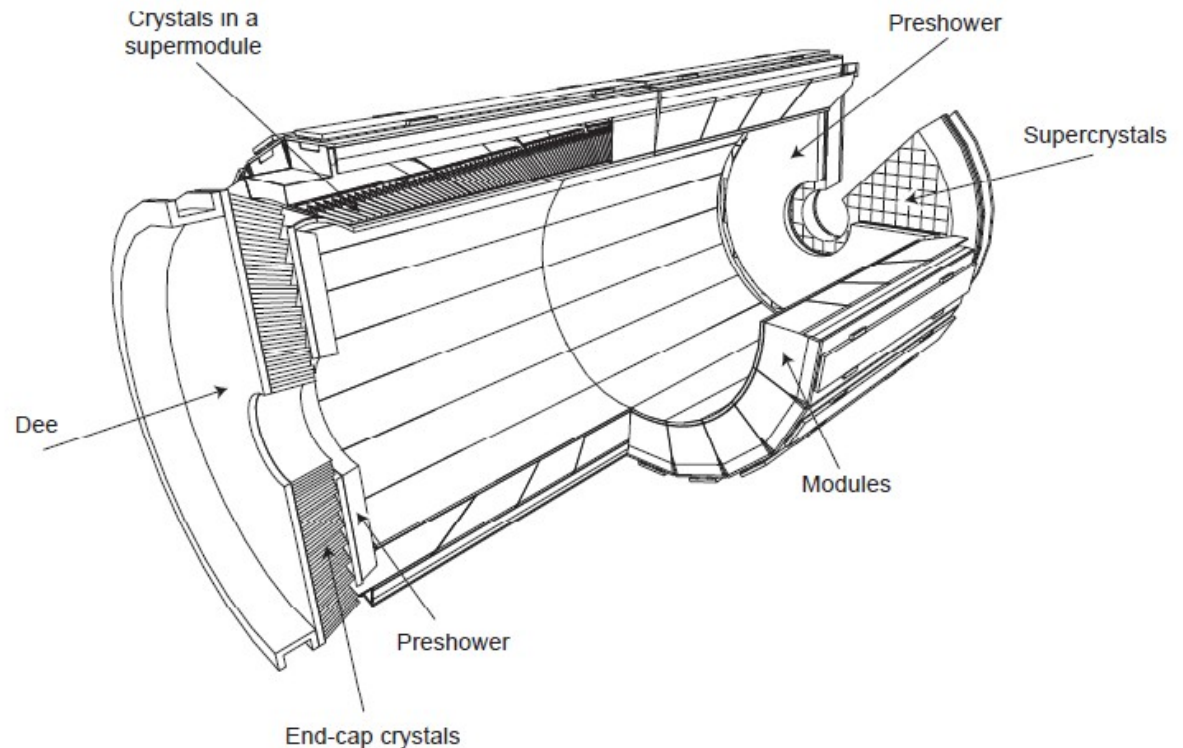

Calorimetry - CMS EMCAL

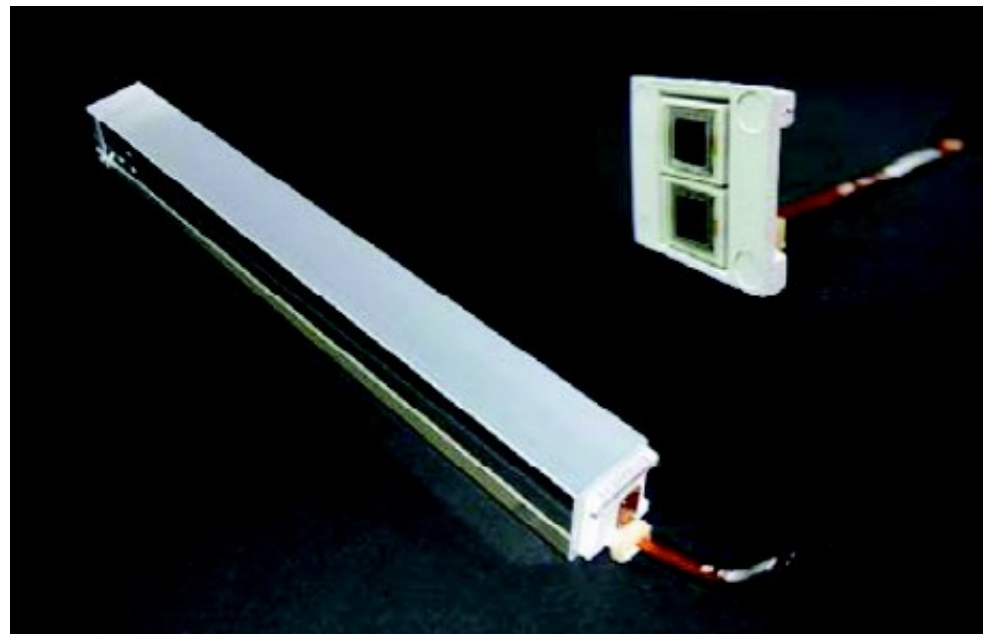
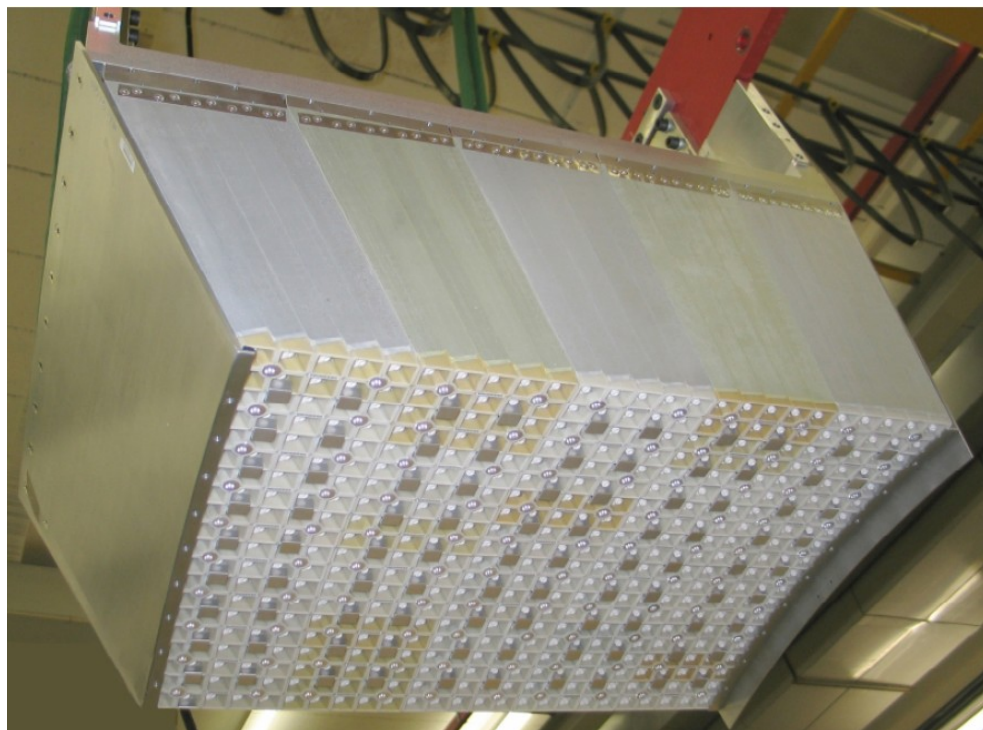

- ◆ 76000 crystals
- ◆ Produced at two places (China, Russia)
- ◆ Took about 10 years to grow all crystals

Calorimetry - CMS HCAL

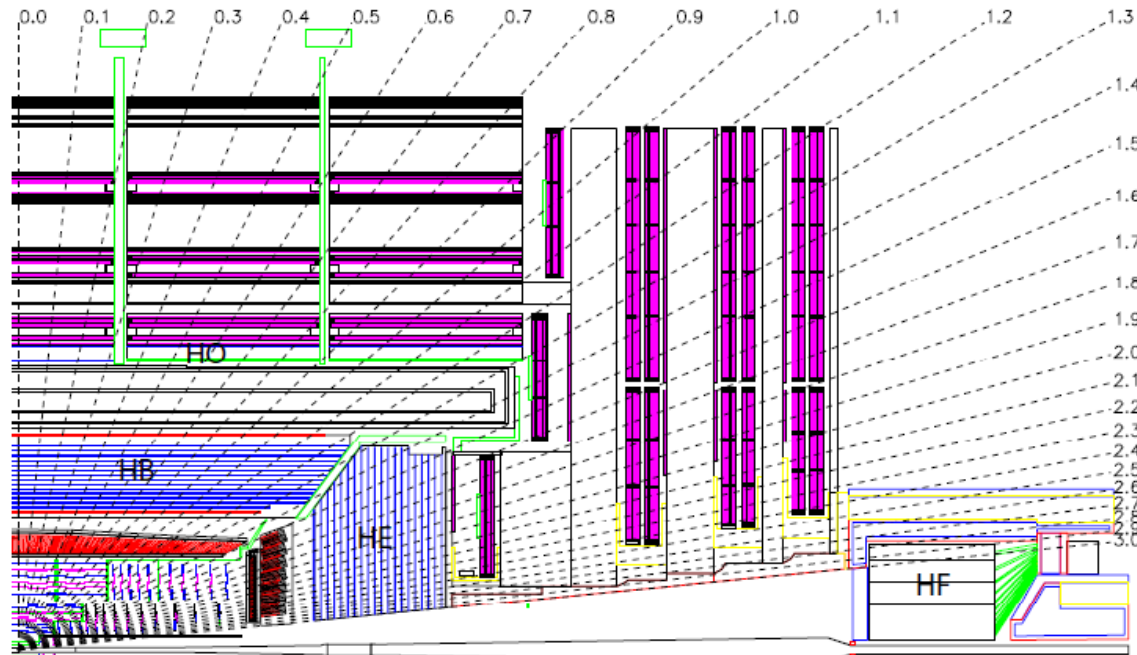
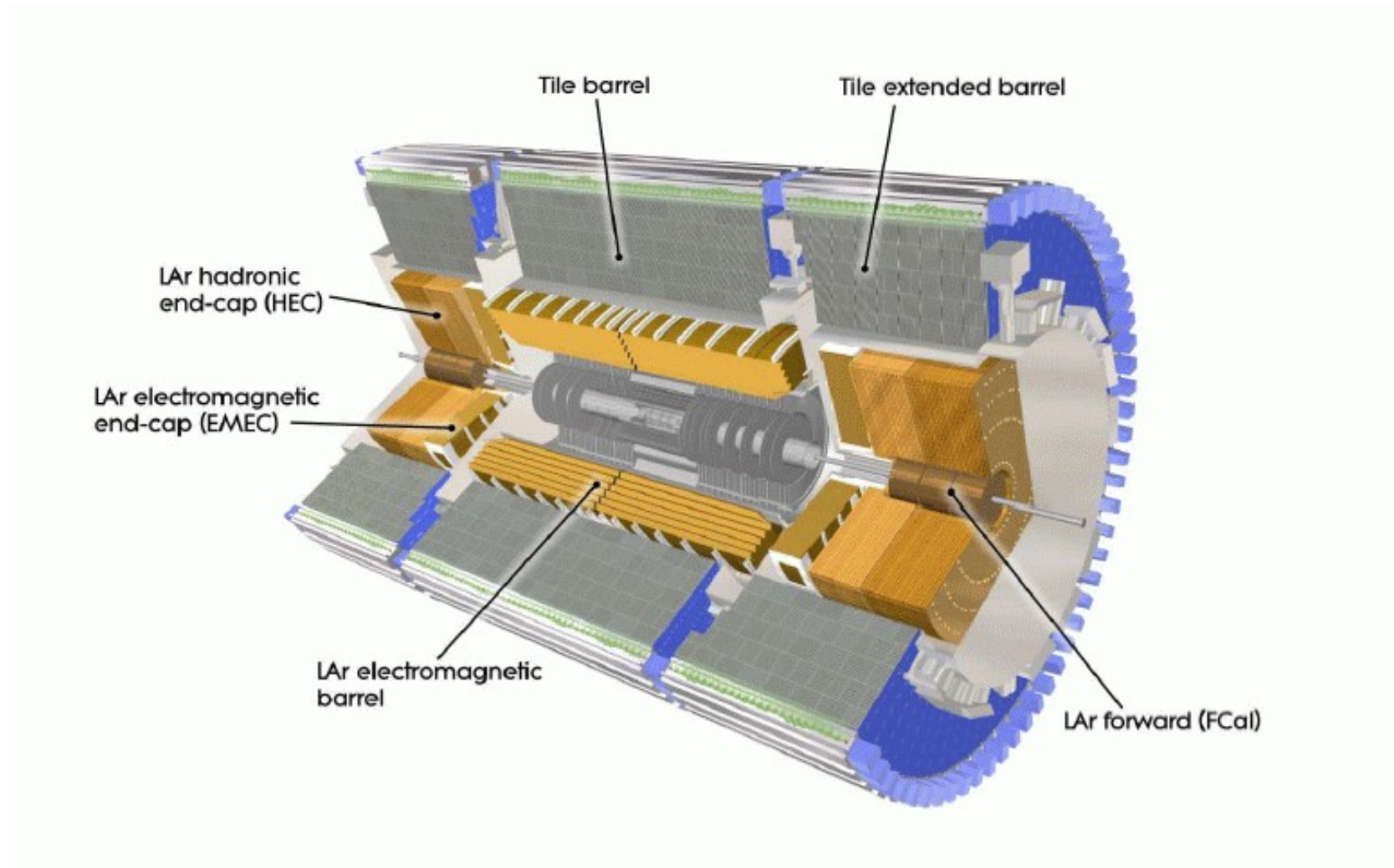

Figure 5.1: Longitudinal view of the CMS detector showing the locations of the hadron barrel (HB), endcap (HE), outer (HO) and forward (HF) calorimeters.

- ◆ Plastic scintillator tiles with fiber readout, copper absorber
- ◆ Not possible to fit sufficient interaction length into the coil ($7.2\lambda_i$ at $\eta=0$), partially compensated by tail catcher (HO)

Calorimetry - ATLAS



Calorimetry - ATLAS - LAr

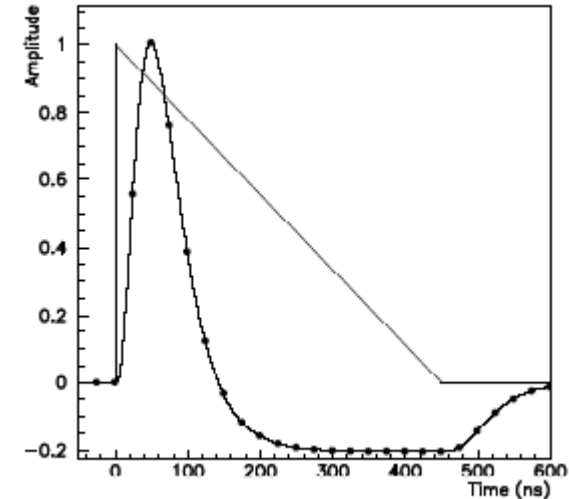
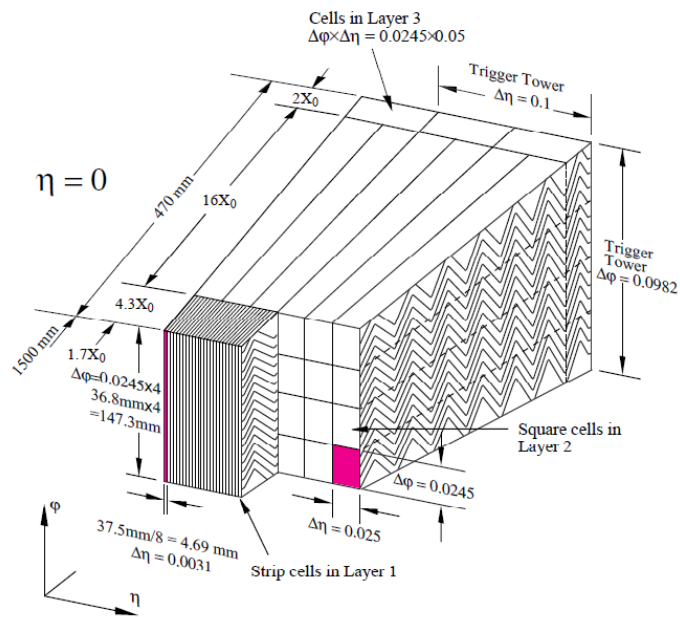

- ◆ EM calorimeter and HAD layer in encap - LAr calorimeters
- ◆ Stable and uniform detector, no dead regions (accordion geometry in barrel)
- ◆ Slow charge collection, compensated by fast shaping
- ◆ Several longitudinal samples (π^0 rejection, dead material corrections)

Calorimetry - ATLAS - Tilecal

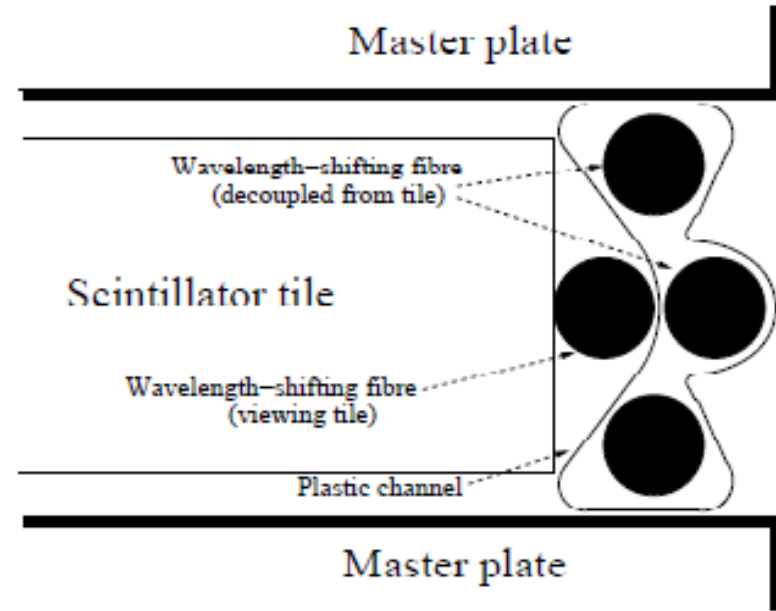
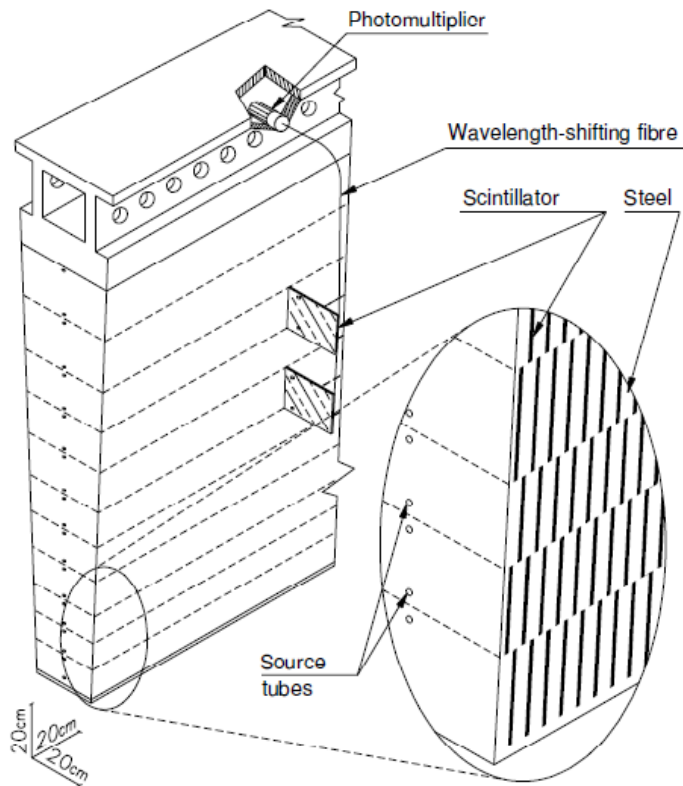

- ◆ TileCal - hadronic calorimeter in barrel region
- ◆ iron/scintillating tiles structure
- ◆ Readout using wavelength-shifting fibres and PMTs

TABLE 8 Main parameters of the ATLAS and CMS electromagnetic calorimeters

Technology	ATLAS		CMS	
	Lead/LAr accordion		PbWO ₄ scintillating crystals	
Channels	Barrel	End caps	Barrel	End caps
	110,208	63,744	61,200	14,648
Granularity	$\Delta\eta \times \Delta\phi$		$\Delta\eta \times \Delta\phi$	
Presampler	0.025×0.1	0.025×0.1		
Strips/ Si-preshower	0.003×0.1	0.003×0.1 to 0.006×0.1		32×32 Si-strips per 4 crystals
Main sampling	0.025×0.025	0.025×0.025	0.017×0.017	0.018×0.003 to 0.088×0.015
Back	0.05×0.025	0.05×0.025		
Depth	Barrel	End caps	Barrel	End caps
Presampler (LAr)	10 mm	2×2 mm		
Strips/ Si-preshower	$\approx 4.3 X_0$	$\approx 4.0 X_0$		$3 X_0$
Main sampling	$\approx 16 X_0$	$\approx 20 X_0$	$26 X_0$	$25 X_0$
Back	$\approx 2 X_0$	$\approx 2 X_0$		
Noise per cluster	250 MeV	250 MeV	200 MeV	600 MeV
Intrinsic resolution	Barrel	End caps	Barrel	End caps
Stochastic term a	10%	10 to 12%	3%	5.5%
Local constant term b	0.2%	0.35%	0.5%	0.5%

Note the presence of the silicon preshower detector in front of the CMS end-cap crystals, which have a variable granularity because of their fixed geometrical size of 29×29 mm². The intrinsic energy resolutions are quoted as parametrizations of the type $\sigma(E)/E = a/\sqrt{E} \oplus b$. For the ATLAS EM barrel and end-cap calorimeters and for the CMS barrel crystals, the numbers quoted are based on stand-alone test-beam measurements.

TABLE 9 Main parameters of the ATLAS and CMS hadronic calorimeters

Technology	ATLAS		CMS	
	Lead/LAr accordion		PbWO ₄ scintillating crystals	
Channels	Barrel	End caps	Barrel	End caps
	9852	5632	3524	2592
Granularity ($\Delta\eta \times \Delta\phi$)	$\Delta\eta \times \Delta\phi$		$\Delta\eta \times \Delta\phi$	
Barrel/Ext. barrel	0.1×0.1 to 0.2×0.1		0.087×0.087	
End caps	0.1×0.1 to 0.2×0.2		0.087×0.087 to 0.18×0.175	
Forward	0.2×0.2		0.175×0.175	
Samplings ($\Delta\eta \times \Delta\phi$)	$\Delta\eta \times \Delta\phi$		$\Delta\eta \times \Delta\phi$	
Barrel/Ext. barrel	3		1	
End caps	4		2	
Forward	3		2	
Abs. lengths (min.-max.)	min.-max.		min.-max.	
Barrel/Ext. barrel	9.7–13.0		7.2–11.0	
End caps	9.7–12.5		10–14 (with coil/HO)	
Forward	9.5–10.5		9.8	

Note that the CMS barrel calorimeter (HB) is complemented by a tail catcher behind the coil (HO) to minimize problems with longitudinal leakage of high-energy particles in jets.

Inner tracker - CMS

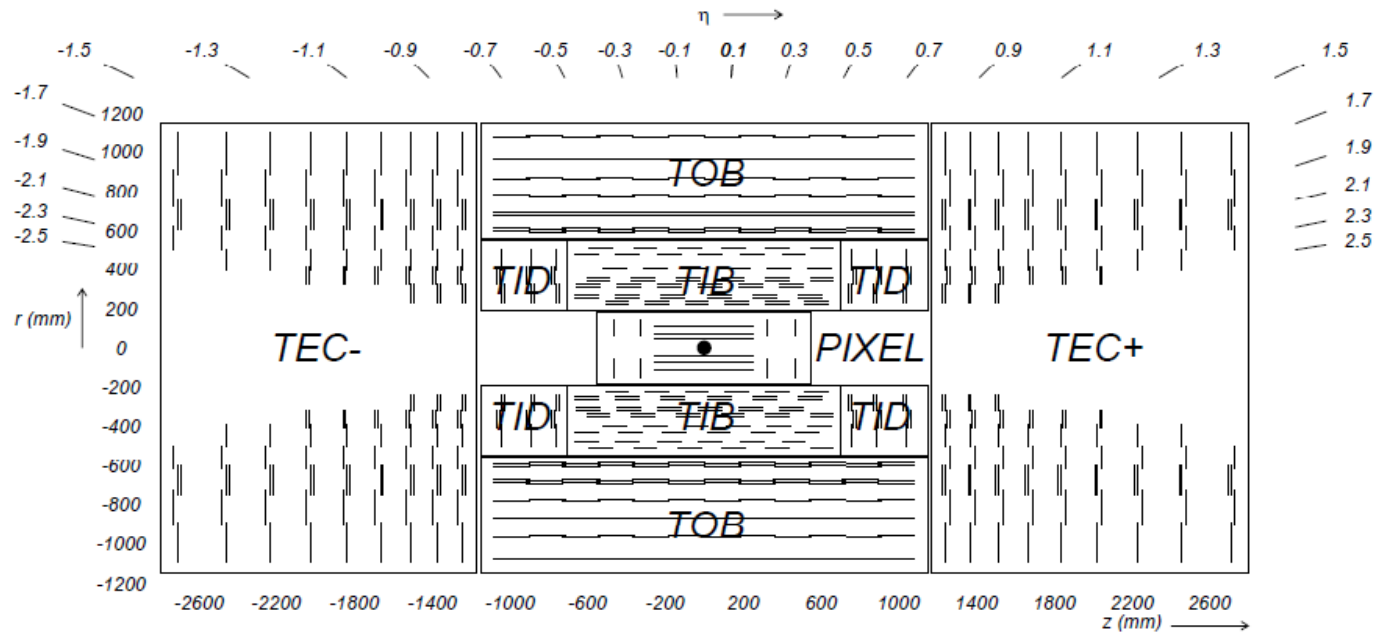

- ◆ Silicon detectors:
 - ➔ Pixel systems at small radius (high granularity)
 - ➔ Then silicon strips
- ◆ Need high radiation hardness
- ◆ Difficult to minimize amount of dead material in front of calorimeters

Inner tracker - CMS

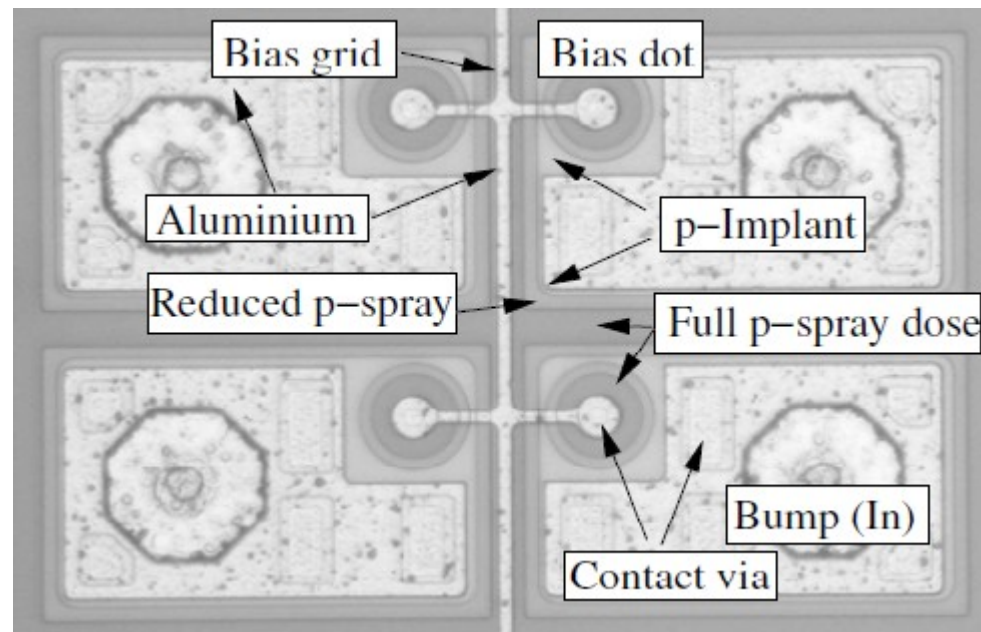
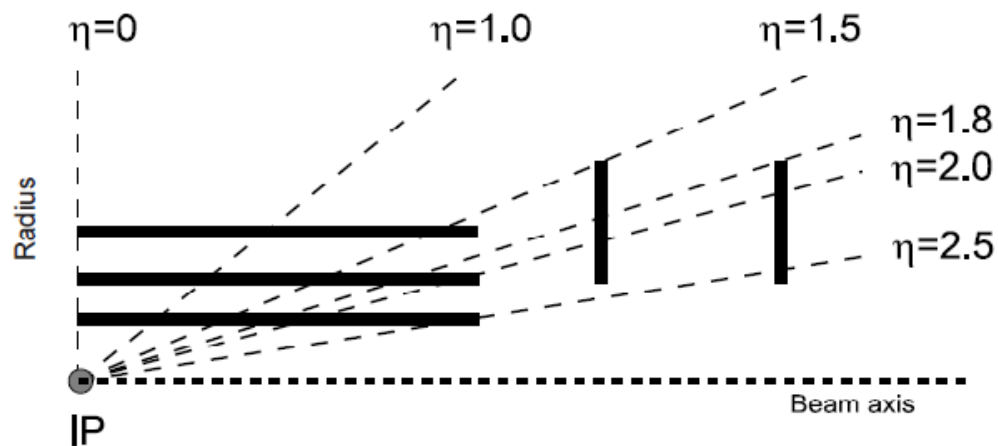

- ◆ 66 million channels (ATLAS similar size, 80 M channels)
- ◆ Three points per track

Inner tracker - ATLAS I

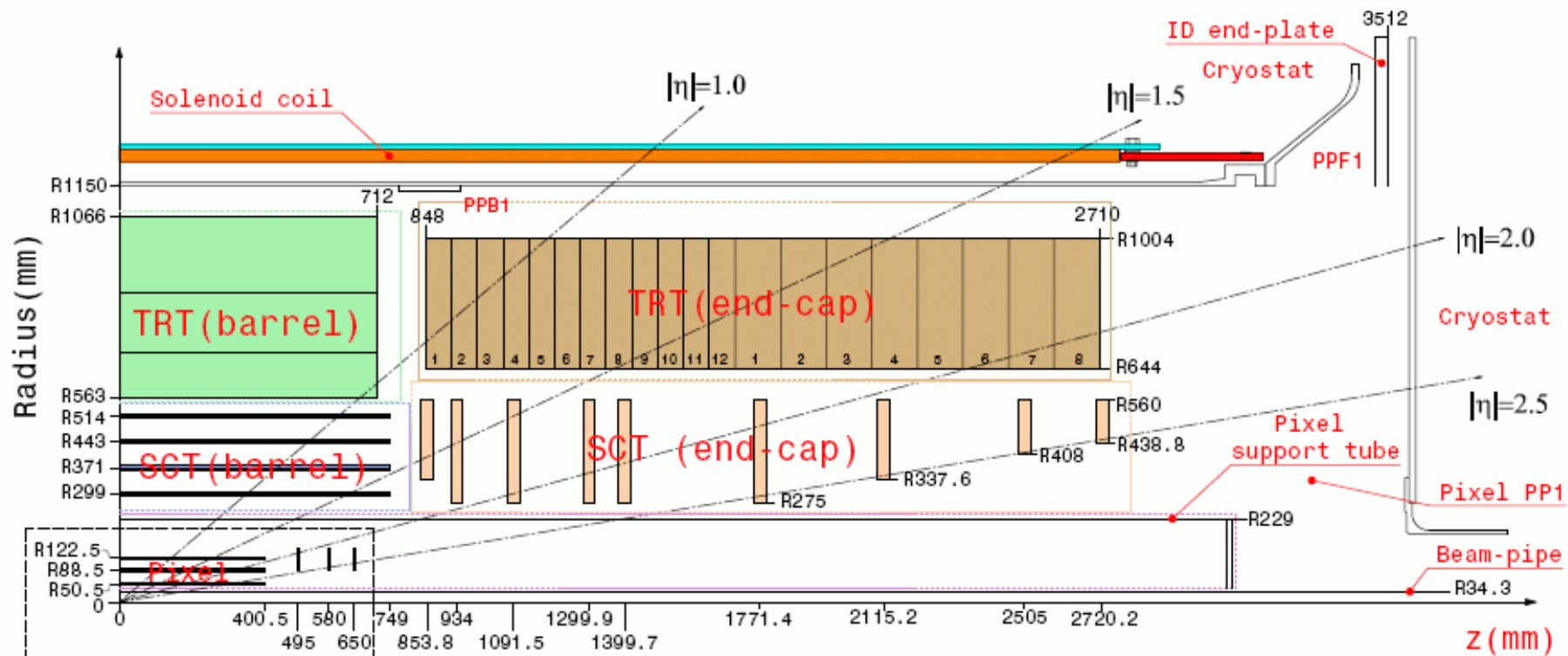

Inner tracker - ATLAS

- ◆ Low radius - pixels (3 layers in Run 1, another layer inserted in 2015)
- ◆ Then strips (SCT)
- ◆ At larger radius, additional detector - TRT (transition radiation tracker)

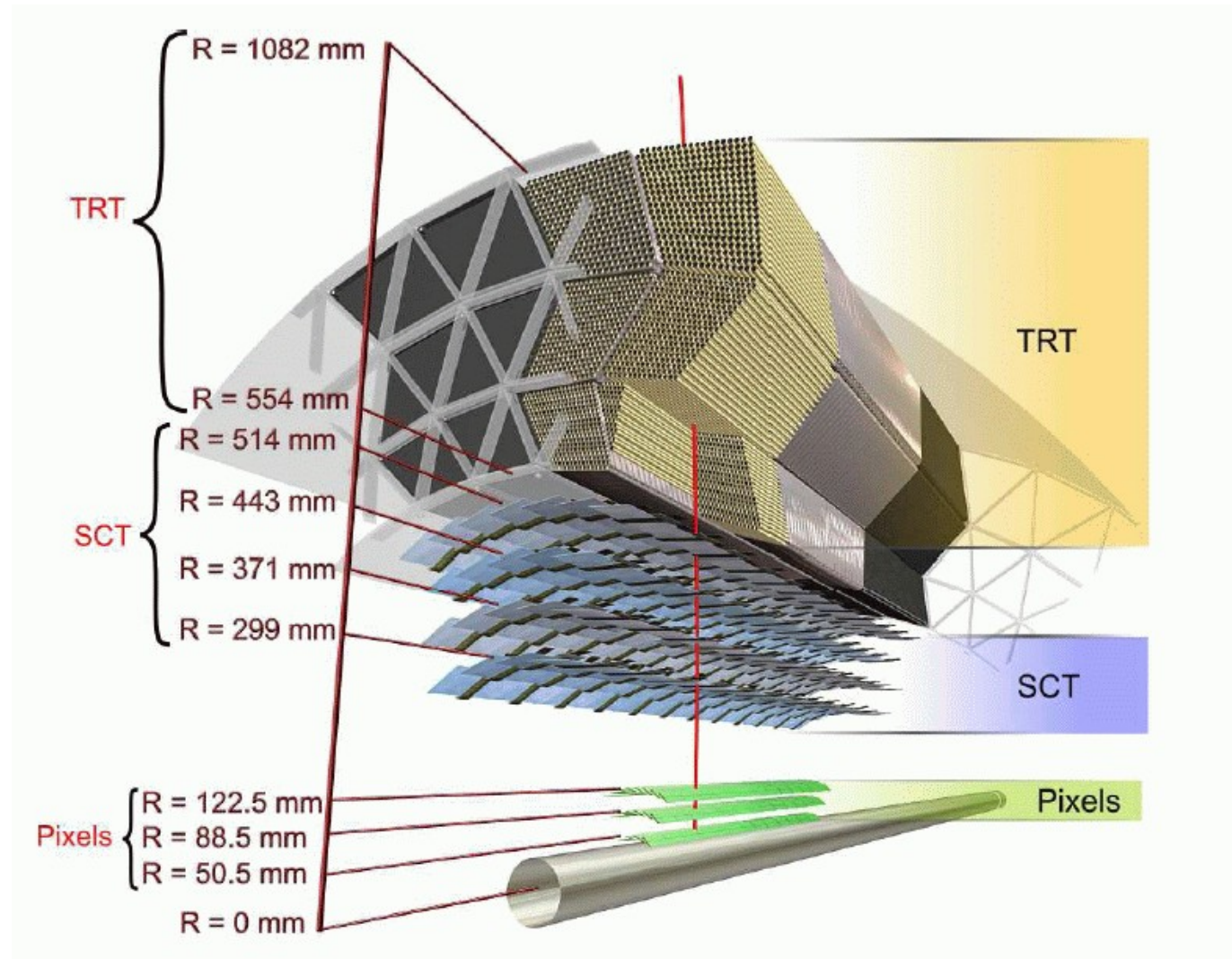

Inner tracker - ATLAS TRT

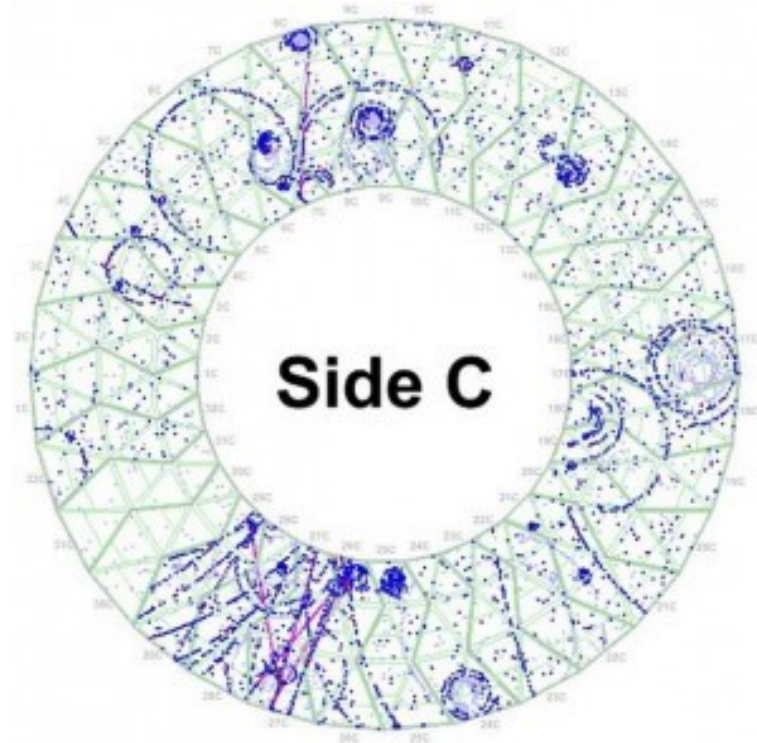
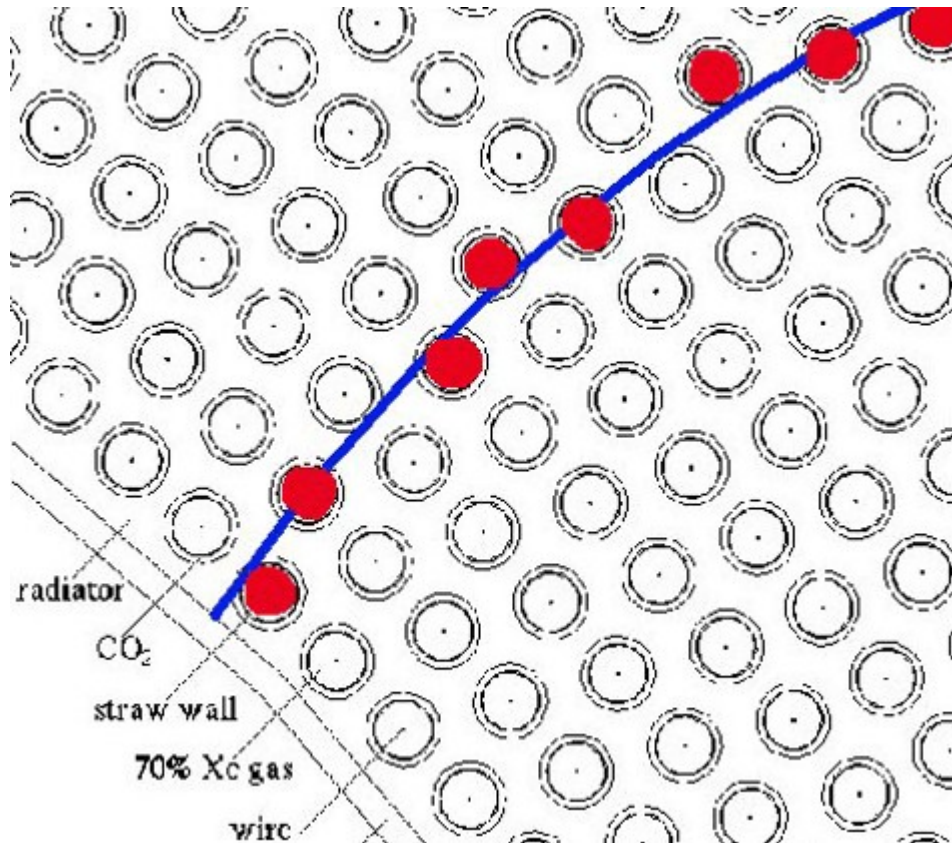

- ◆ Drift tubes (straw tubes) filled with Xe-CO₂-O₂ (70/27/3) mixture (part of the detector using Ar mixture in Run 2)
- ◆ Contributes to momentum measurement (~35 points/track)
- ◆ Electron identification via sensitivity to X-rays from transition radiation

TABLE 6 Main parameters of the ATLAS and CMS pixel systems

	ATLAS	CMS
Number of hits per track	3	3
Total number of channels	80 10^6	66 10^6
Pixel size (μm in $R\phi \times \mu\text{m}$ in z/R)	50 \times 400	100 \times 150
Lorentz angle (degrees), initial to end	12 to 4	26 to 8
Tilt in $R\phi$ (degrees)	20 (only barrel)	20 (only end cap)
Total active area of silicon (m^2)	1.7 (n^+/n)	1.0 (n^+/n)
Sensor thickness (μm)	250	285
Total number of modules	1744 (288 in disks)	1440 (672 in disks)
Barrel layer radii (cm)	5.1, 8.9, 12.3	4.4, 7.3, 10.2
Disk layer min. to max. radii (cm)	8.9 to 15.0	6.0 to 15.0
Disk positions in z (cm)	49.5, 58.0, 65.0	34.5, 46.5
Signal-to-noise ratio for minimum ionizing particles (day 1)	120	130
Total fluence at $L = 10^{34}$ ($n_{eq}/\text{cm}^2/\text{year}$) at radius of 4–5 cm (innermost layer)	3×10^{14}	3×10^{14}
Signal-to-noise ratio (after 10^{15} n_{eq}/cm^2)	80	80
Resolution in $R\phi$ (μm)	≈ 10	≈ 10
Resolution in z/R (μm)	≈ 100	≈ 20

TABLE 4 Main parameters of the ATLAS and CMS tracking systems (see Table 6 for details of the pixel systems)

Parameter	ATLAS	CMS
Dimensions (cm)		
-radius of outermost measurement	101–107	107–110
-radius of innermost measurement	5.0	4.4
-total active length	560	540
Magnetic field B (T)	2	4
BR ² (T \cdot m ²)	2.0 to 2.3	4.6 to 4.8
Total power on detector (kW)	70	60
Total weight in tracker volume (kg)	≈ 4500	≈ 3700
Total material (X/X ₀)		
-at $\eta \approx 0$ (minimum material)	0.3	0.4
-at $\eta \approx 1.7$ (maximum material)	1.2	1.5
-at $\eta \approx 2.5$ (edge of acceptance)	0.5	0.8
Total material (λ/λ_0 at max)	0.35	0.42
Silicon microstrip detectors		
-number of hits per track	8	14
-radius of innermost meas. (cm)	30	20
-total active area of silicon (m^2)	60	200
-wafer thickness (microns)	280	320/500
-total number of channels	6.2×10^6	9.6×10^6
-cell size (μm in $R\phi \times \text{cm}$ in z/R)	80 \times 12	80/120 \times 10
-cell size (μm in $R\phi \times \text{cm}$ in z/R)		and 120/180 \times 25
Straw drift tubes (ATLAS only)		
-number of hits per track ($ \eta < 1.8$)	35	
-total number of channels	350,000	
-cell size (mm in $R\phi \times \text{cm}$ in z)	4 \times 70 (barrel)	
	4 \times 40 (end caps)	

ATLAS insertable pixel layer (IBL)

- ◆ Insertable B-Layer (IBL):
 - New 4th pixel layer, installed during LS1
 - Additional layer at 33 mm from the beam axis
 - Mounted on the beam-pipe
 - Smaller pixels than in other layers ($50 \times 250 \mu\text{m}^2$ vs $50 \times 400 \mu\text{m}^2$)
- ◆ Improvements:
 - Better impact parameter resolution
 - More robust b-tagging
 - Better tracking at high p_T

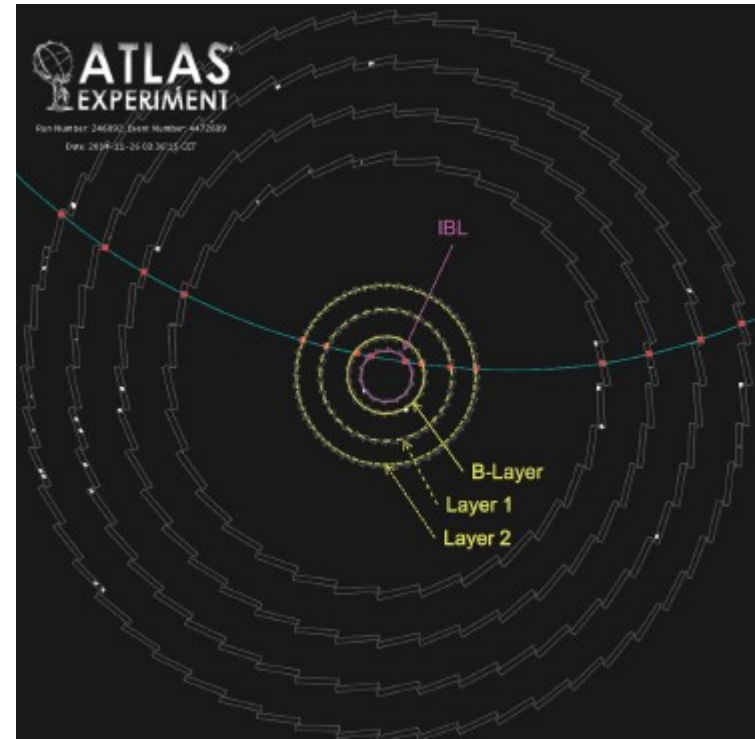

Muon system - ATLAS

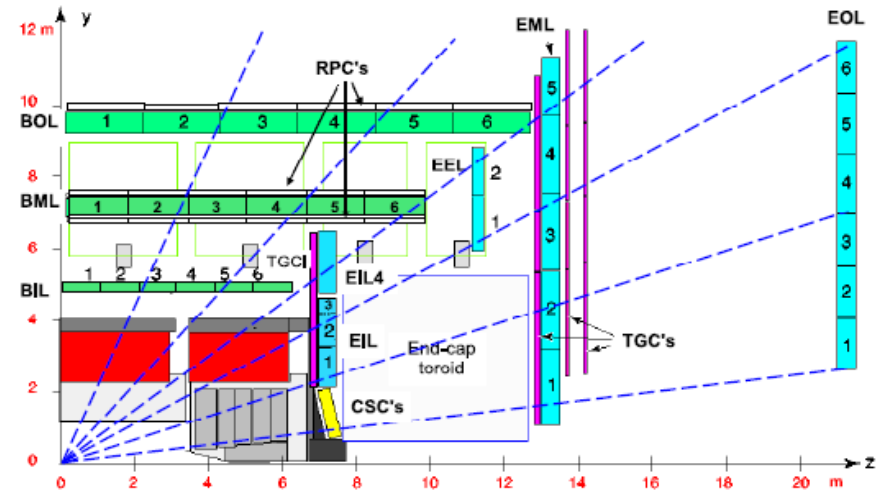
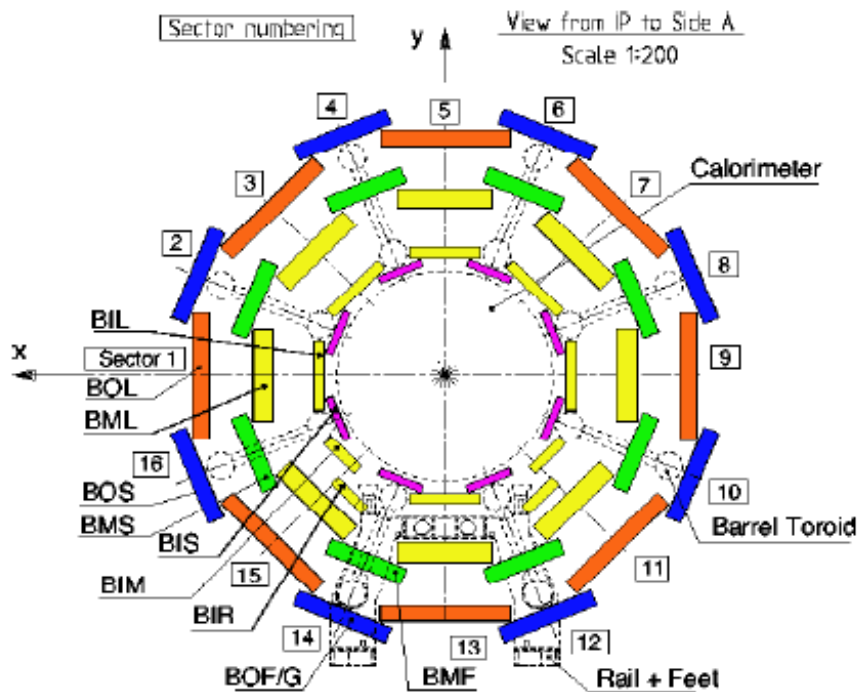

- ◆ Need good tracking over large volumes
- ◆ In case of ATLAS also need to know non-uniform magnetic field
- ◆ One group of chambers for precision position measurement (MDT's and CSC's in forward region), dedicated chambers for triggering (RPC's and TGC's in forward region)

Muon system - ATLAS

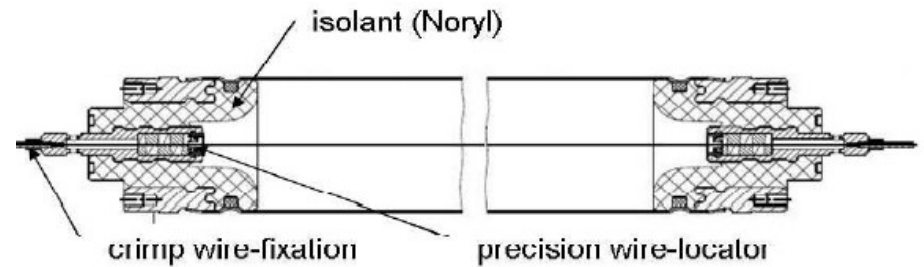
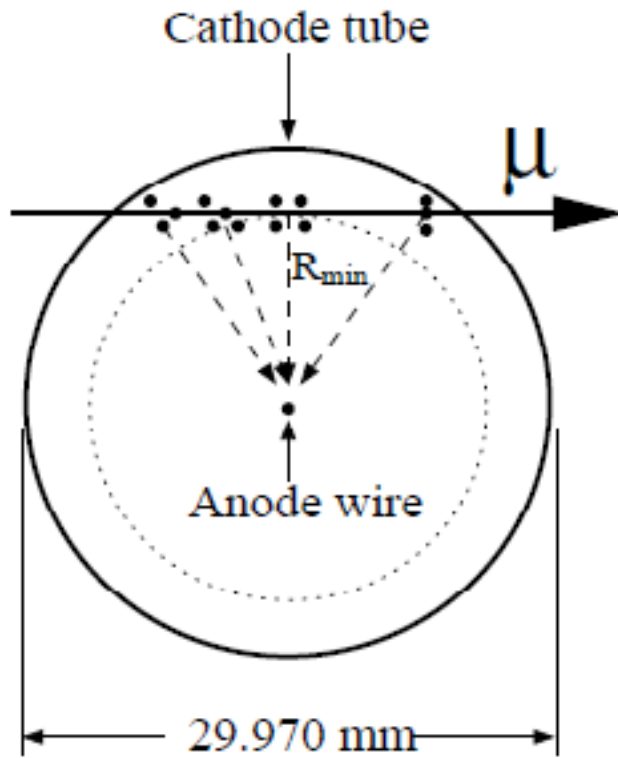

- ◆ Drift tubes operating with Ar-CO₂ (93-7) gas mixture

Muon system - CMS I

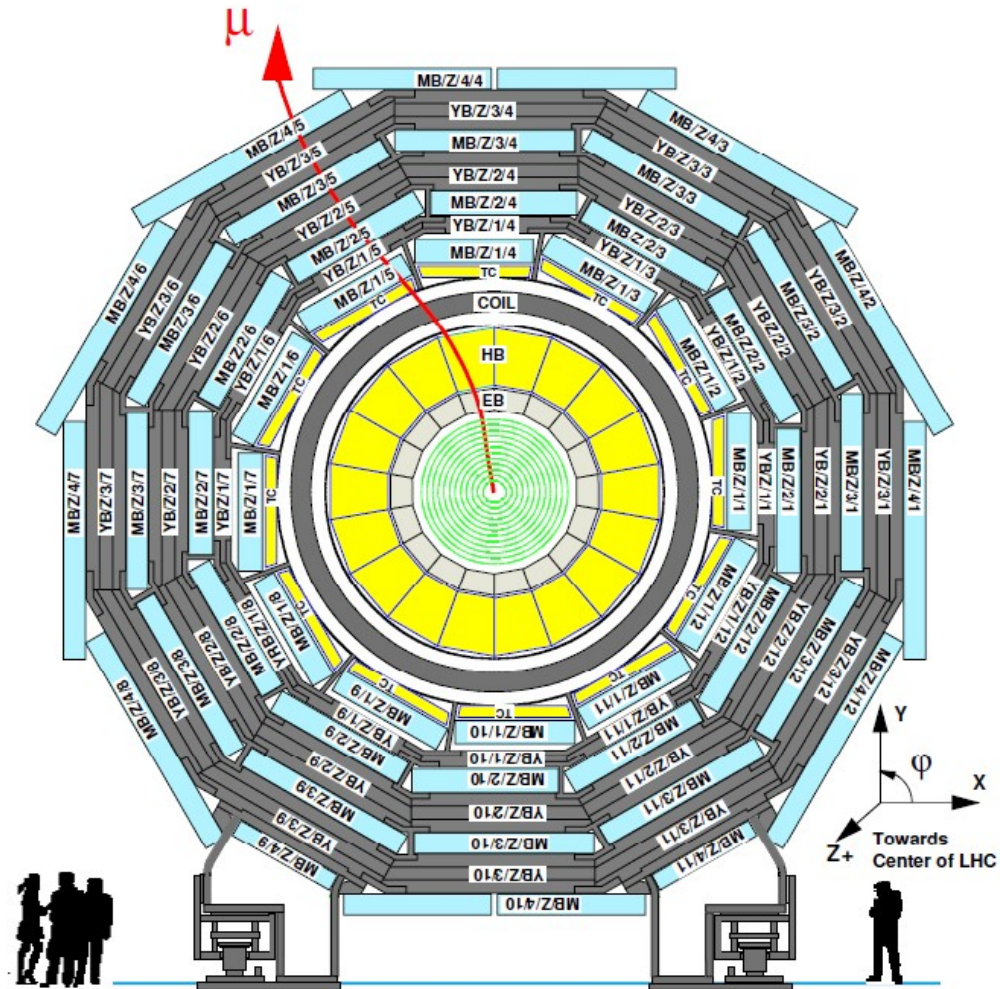

- ◆ Installed between the iron slabs that provide the return yoke for the magnetic field of the solenoid

Muon system - CMS II

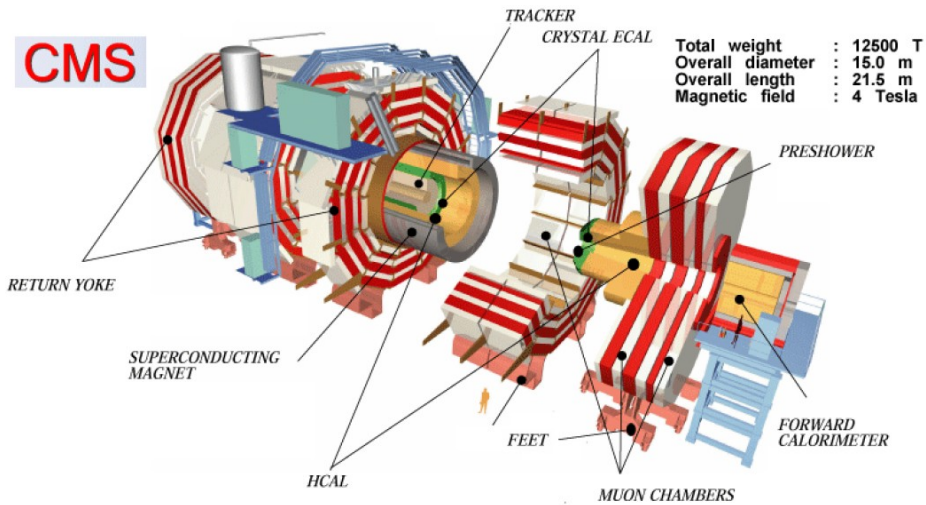

DT:

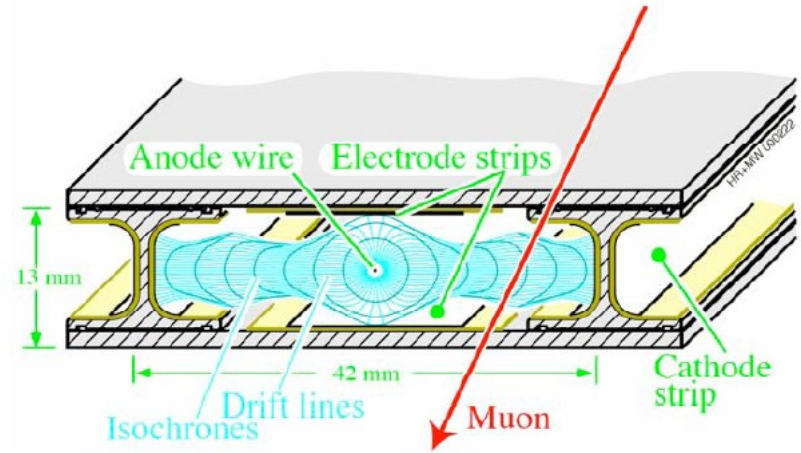

CSC:

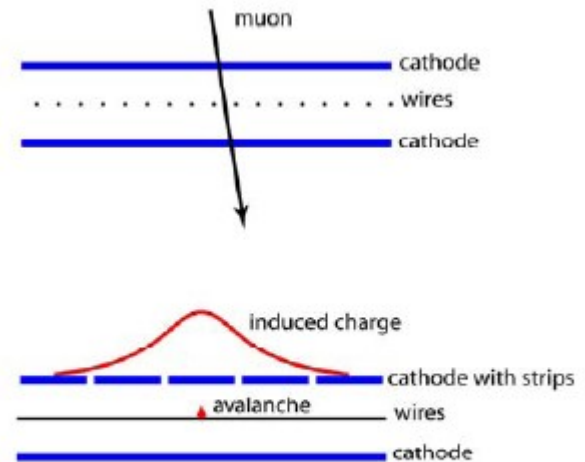

Muon systems - alignment

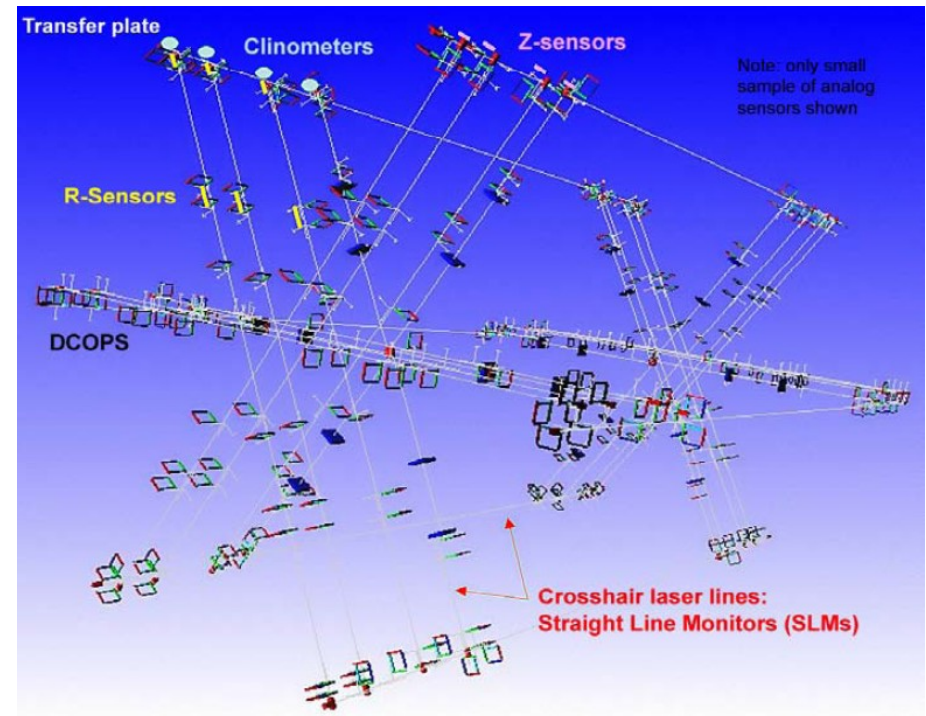
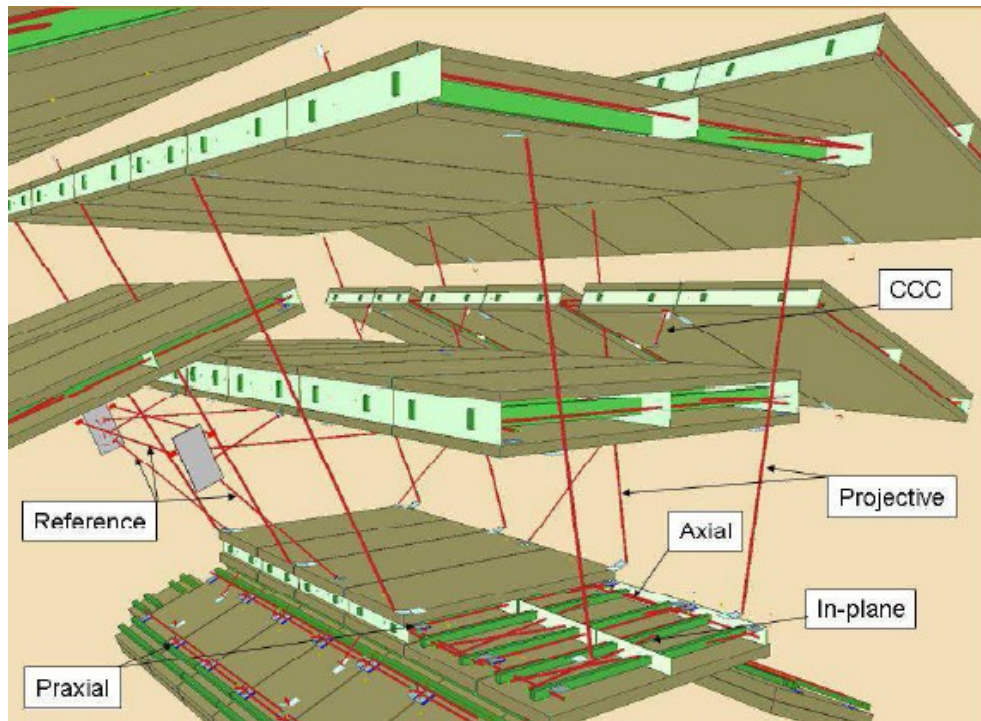

The chambers need to be aligned w.r.t. each other and central tracking:

- CMS 100-500 μm
- ATLAS $\sim 30 \mu\text{m}$

TABLE 11 Main parameters of the ATLAS and CMS muon chambers

	ATLAS	CMS
Drift Tubes	MDTs	DTs
-Coverage	$ \eta < 2.0$	$ \eta < 1.2$
-Number of chambers	1170	250
-Number of channels	354,000	172,000
-Function	Precision measurement	Precision measurement, triggering
Cathode Strip Chambers		
-Coverage	$2.0 < \eta < 2.7$	$1.2 < \eta < 2.4$
-Number of chambers	32	468
-Number of channels	31,000	500,000
-Function	Precision measurement	Precision measurement, triggering
Resistive Plate Chambers		
-Coverage	$ \eta < 1.05$	$ \eta < 2.1$
-Number of chambers	1112	912
-Number of channels	374,000	160,000
-Function	Triggering, second coordinate	Triggering
Thin Gap Chambers		
-Coverage	$1.05 < \eta < 2.4$	—
-Number of chambers	1578	—
-Number of channels	322,000	—
-Function	Triggering, second coordinate	—

Trigger - CMS I

- Both ATLAS and CMS have sophisticated multilevel triggers
- Next level uses more detailed information and has more time to process it
- First level has to be built from dedicated hardware (40 MHz is too fast for standard CPUs)
- Uses reduced granularity information

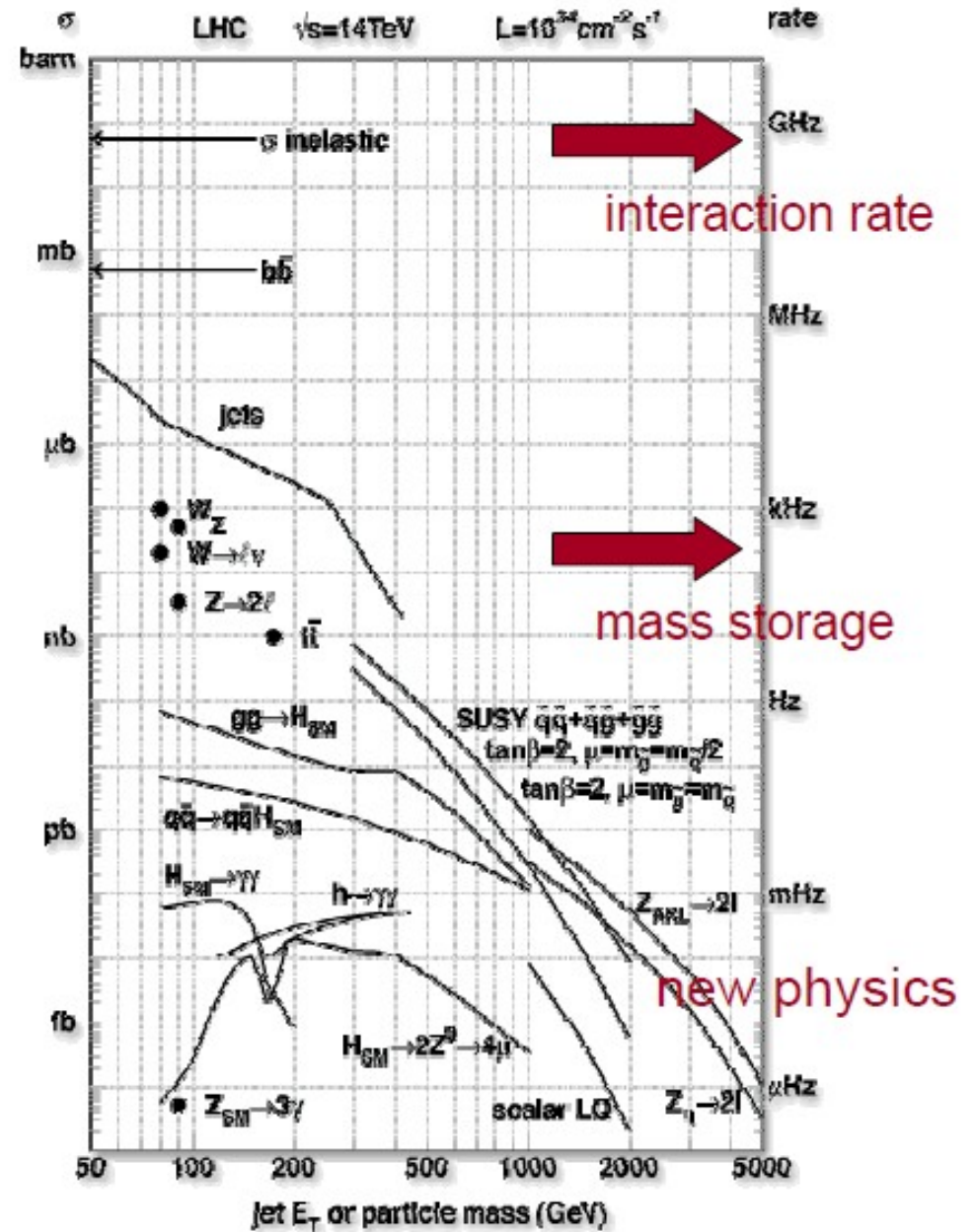

L1 Trigger - CMS

- Fast readout of the detector with course granularity:
 - New hardware in 2016 for better performance.

Muon Rate reduction x2-3 with similar efficiency

- μ GMT – μ TCA Global Muon Trigger

- Select 8 leading muon candidates (using DT in barrel, CSC in endcap).

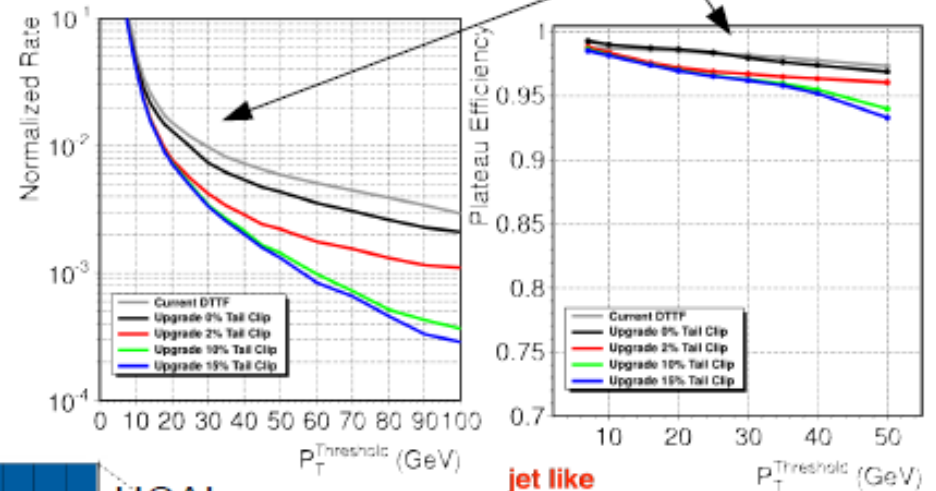

- L1 Calo Trigger (layer 1):

- combines inputs from ECAL (5x5 crystals) and HCAL into “trigger towers”;
- applies position/energy dependent calibrations.

- L1 Calo Trigger (layer 2):

- pattern recognition: (jets, e/γ , τ);
- computes global quantities: ET / MET, HT / MHT.

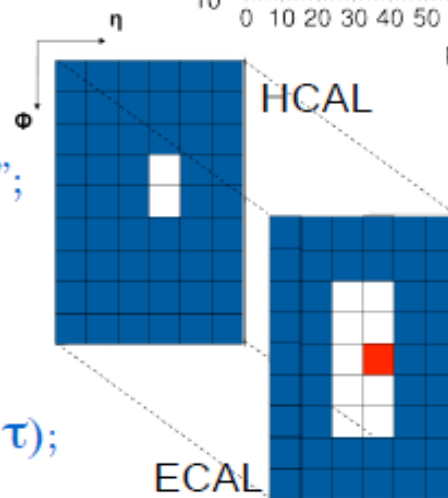

$$\text{Isolation} = E + H_{6 \times 9} - E_{2 \times 5} - H_{1 \times 2}$$

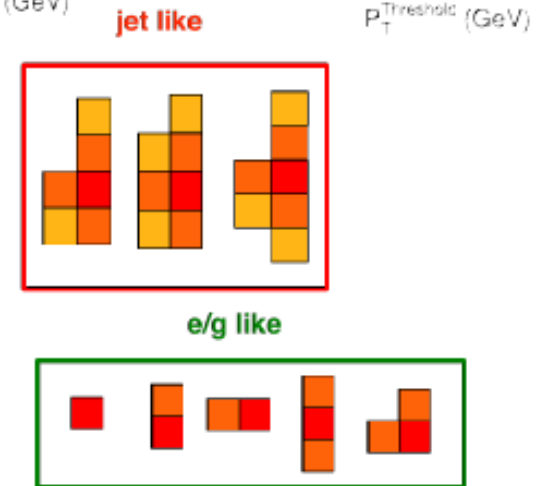

Examples of cluster shapes 15

02/03/2016 LHCC Open Session, Matteo Sani

HL Trigger - CMS

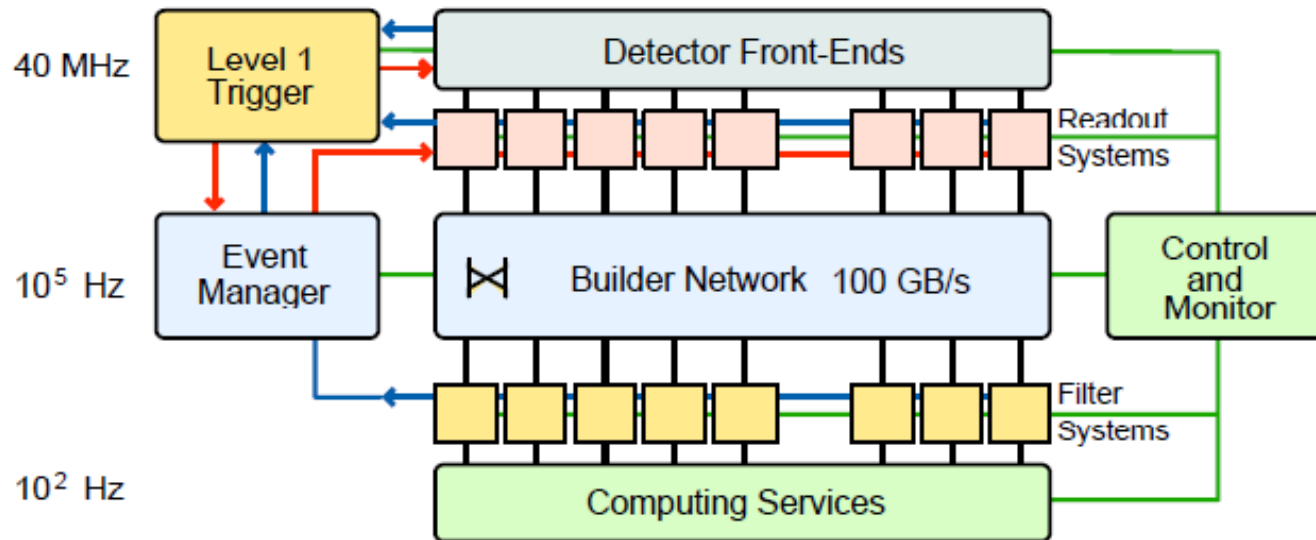

- ◆ CMS has two level trigger, all events accepted by L1 are processed by high level trigger farm
- ◆ This does fast reconstruction and event rejection
- ◆ Reduces event rate to acceptable level

Trigger - ATLAS I

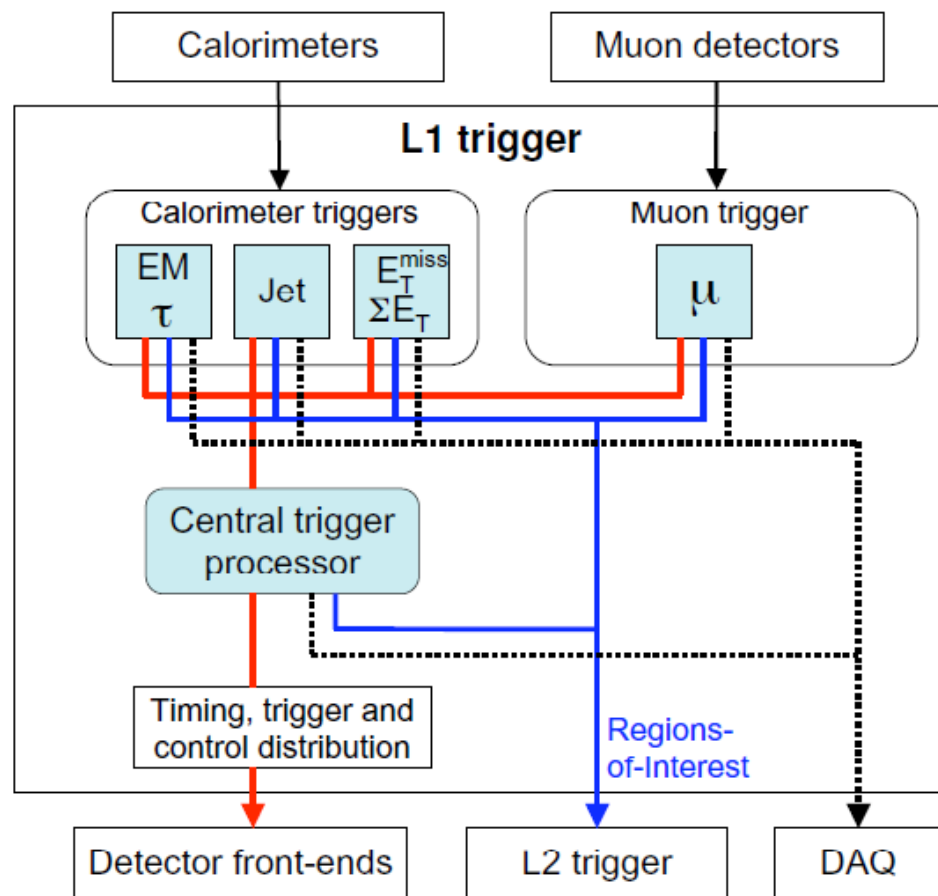

- ◆ Hardware trigger at first level (similar to CMS)

Trigger - ATLAS II

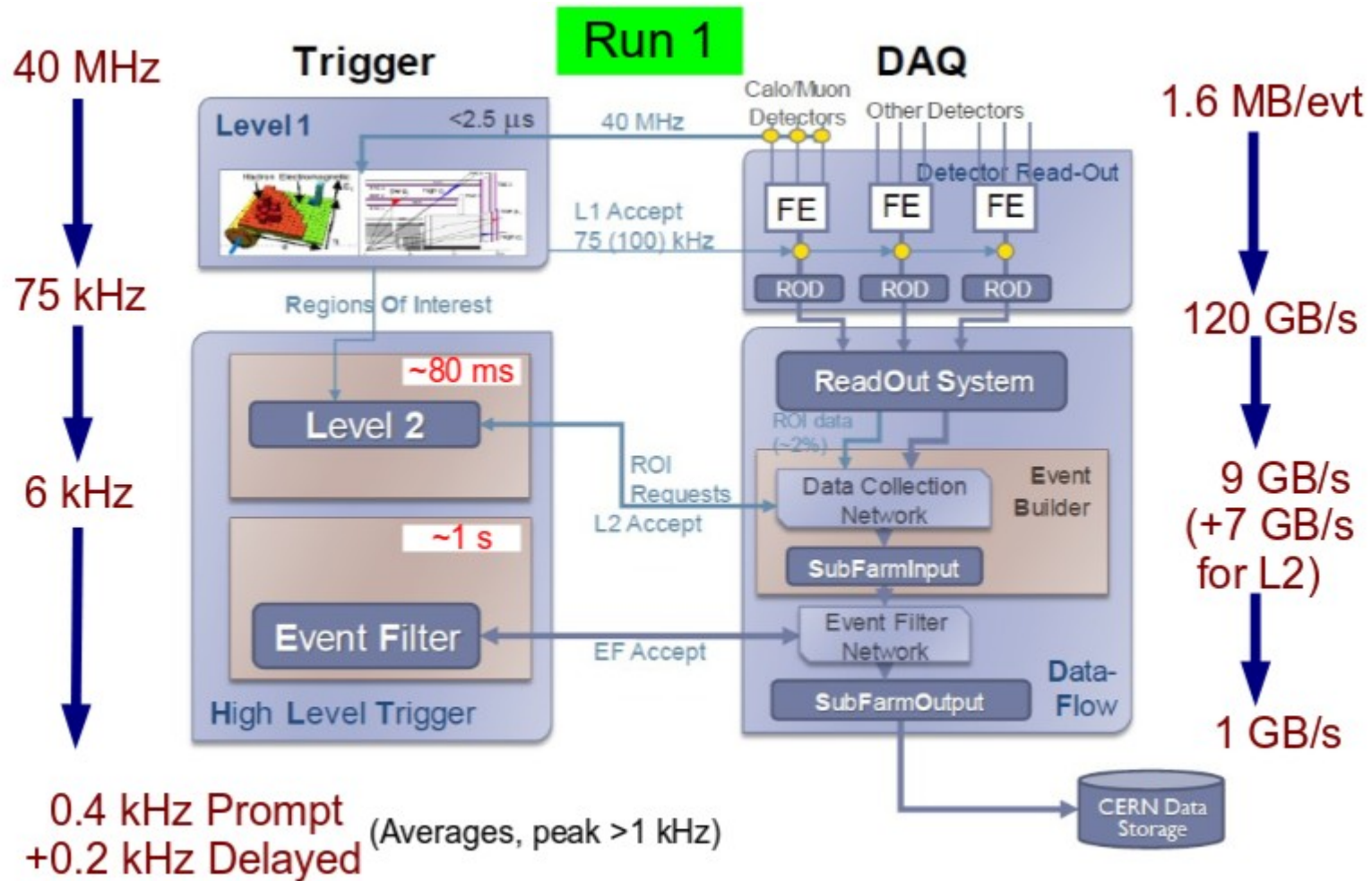

- ◆ Two software based trigger levels:
- ◆ L2 processes full granularity information in areas flagged by L1 (RoIs)
- ◆ EF (L3) processes full events

Trigger - ATLAS III

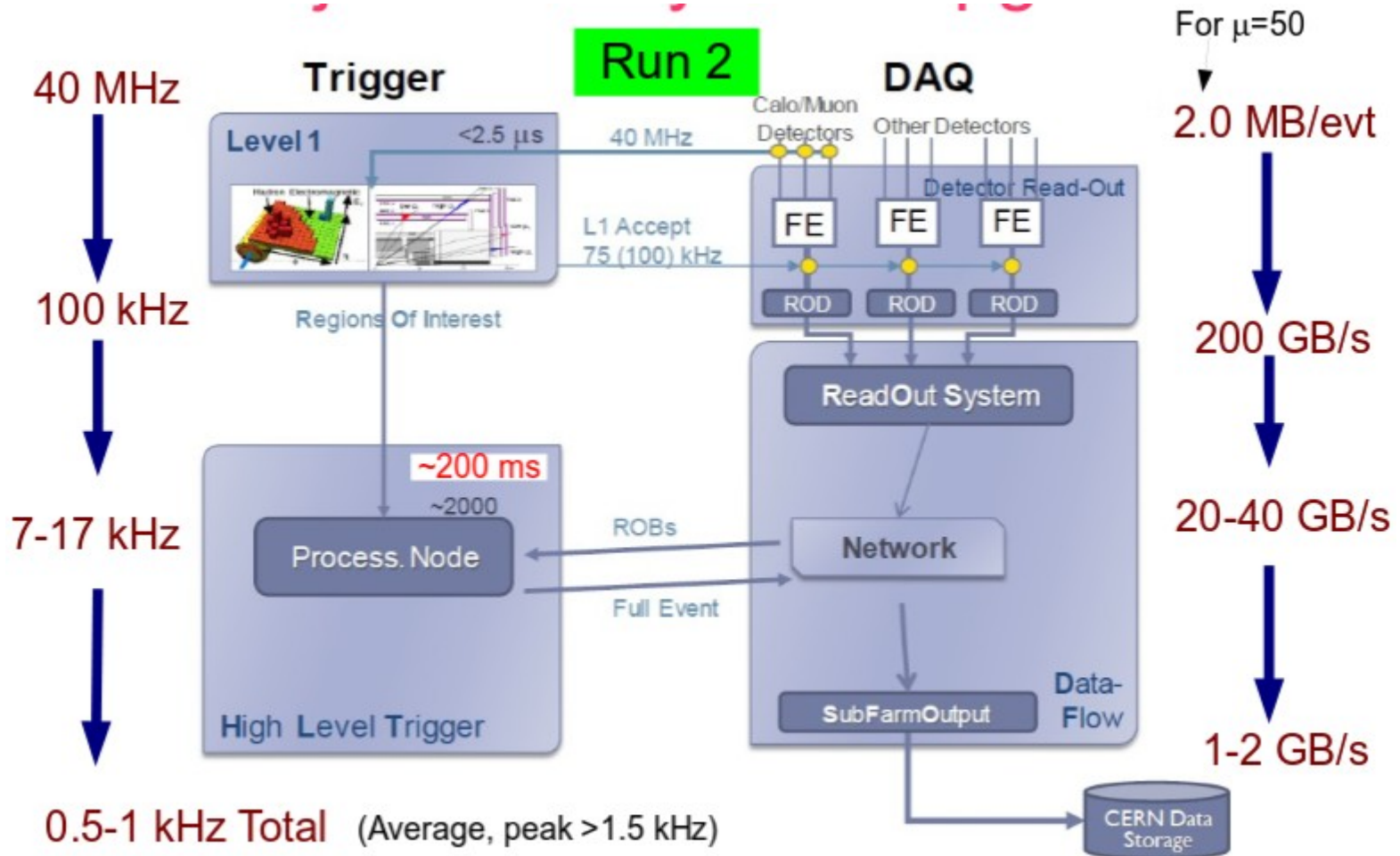

- ◆ In Run 2 logical functionality still there, physically layers merged together ...

Googles of data and the grid

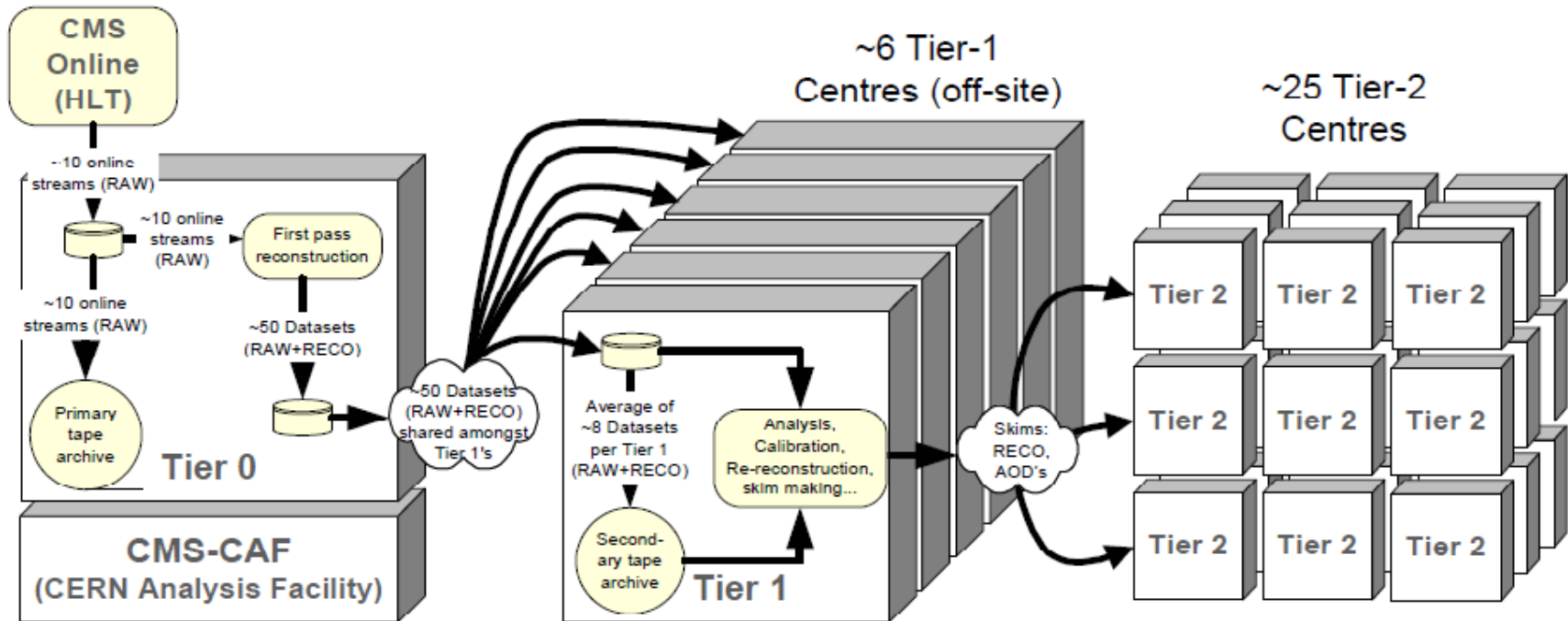

Data analysis and big parts of reconstruction are shared between many computer around the world - the Grid

Googles of data and the grid

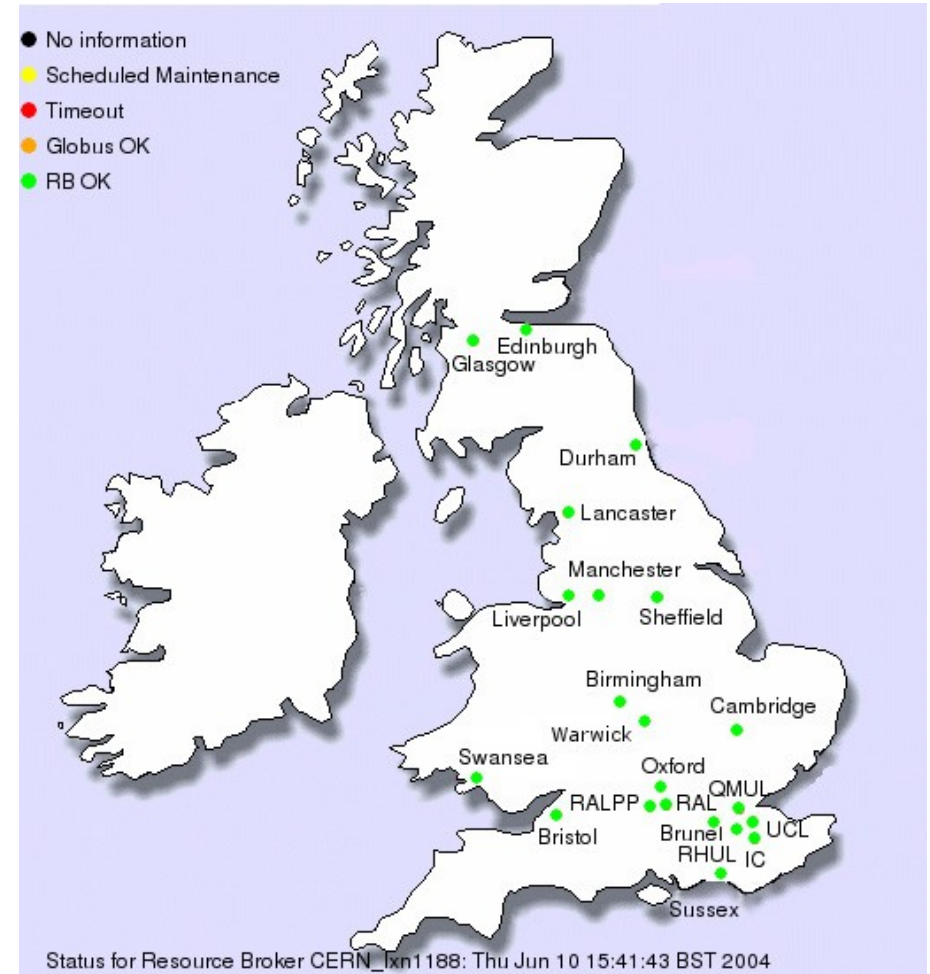
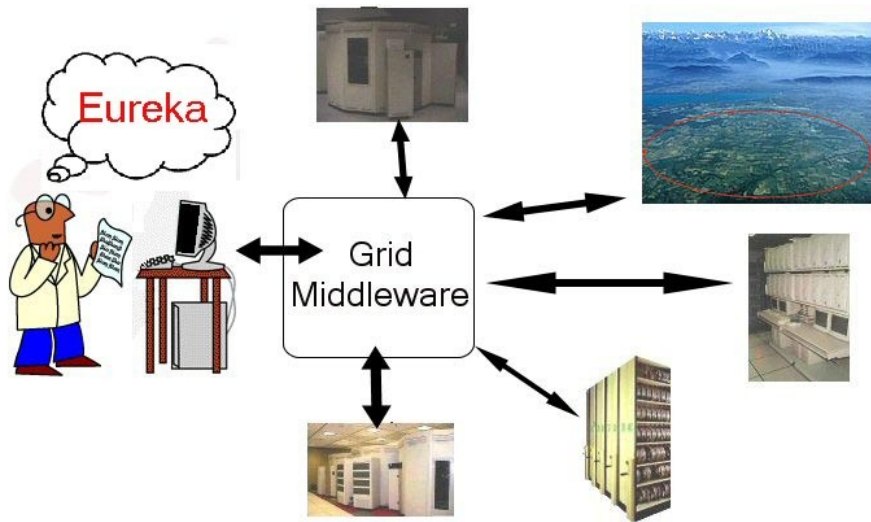

Googles of data and the grid



Next Steps

Beam commissioning

3.5 weeks of re-commissioning with beam

- Mostly **commissioning on machine side**, in preparation for physics production
- Some **activities concerning experiments** will also be carried out (next slides)
- 2-3 days allocated for reconditioning of the vacuum chamber for e-cloud (**scrubbing**) - advanced wrt schedule (place-holder): **end of week 16, beginning of week 17**

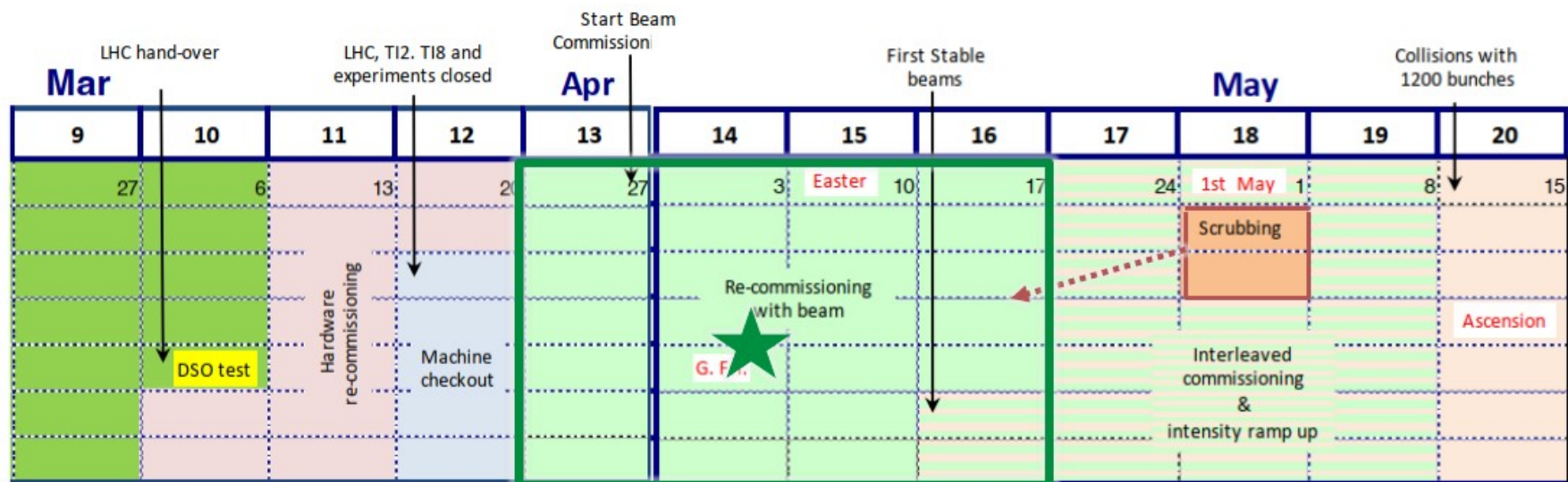

2023 plan

- 2023 is a short year due to early EYETS:
 - 13.5 weeks of pp physics
 - 4 weeks of ion physics
 - + 1 week for pp reference run

Activity	Duration [days]	Ratio [%]
Beam Commissioning & Intensity ramp-up	47	21.7
Scrubbing	2	0.9
25 ns physics (>1200 bunches)	97	44.7
Special physics runs (incl. setting-up)	7	3.2
Pb-Pb ions & p-p ref. setting-up	6	2.8
Pb-Pb ions physics & p-p ref. run	32	14.7
Technical stop	8	3.7
Technical stop recovery	2	0.9
Machine Development blocks (incl. floating MDs)	16	7.4
Total:	217	100%

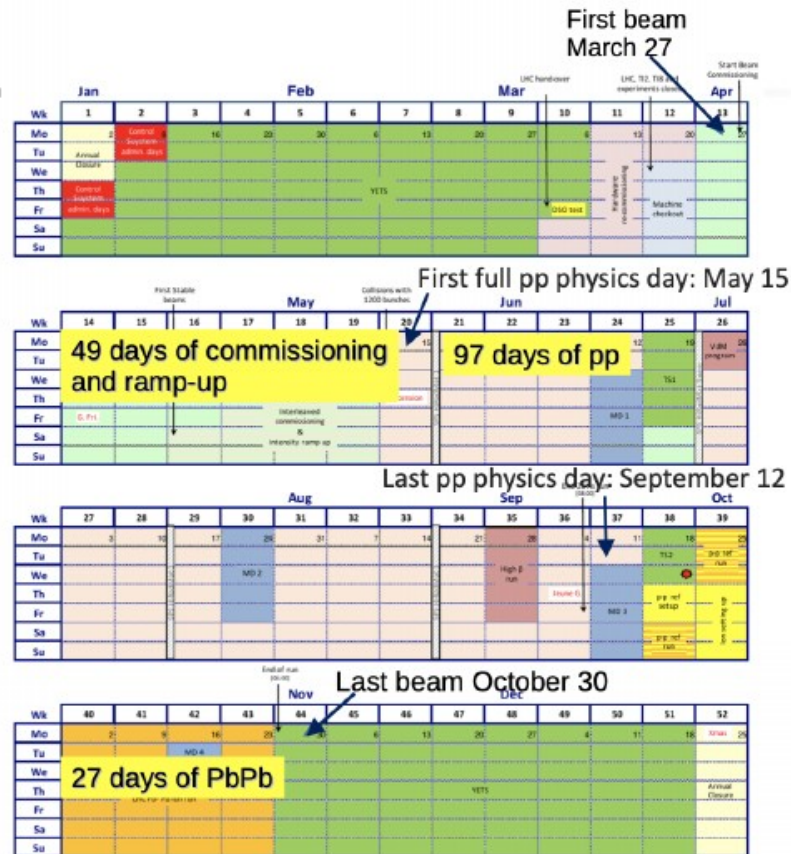

Phase-II upgrades

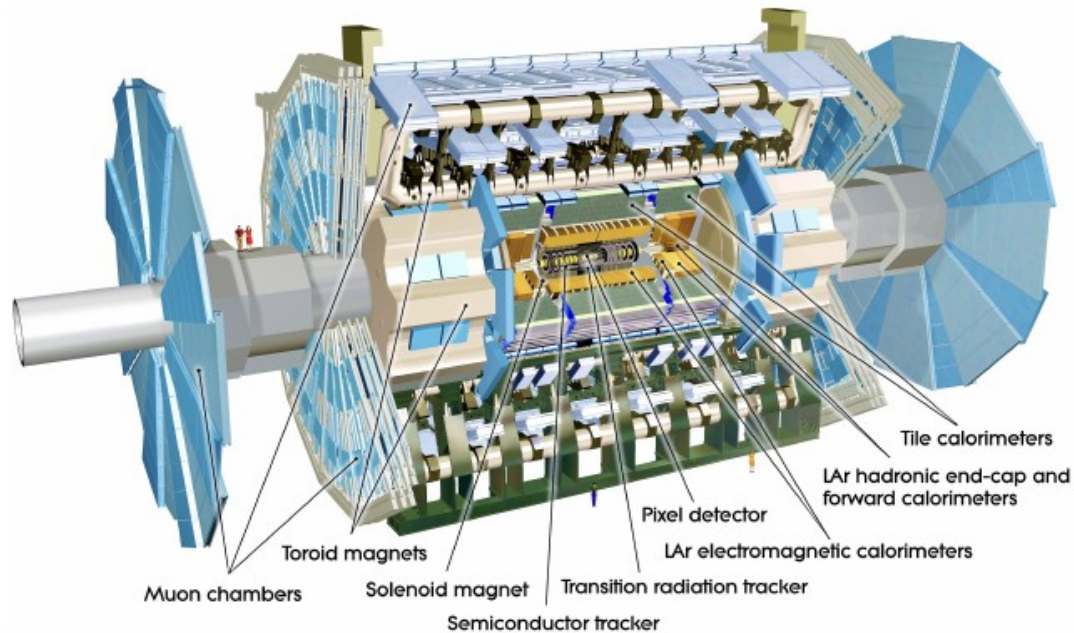

New Muon Chambers
Inner barrel region with new
RPC and sMDT detectors

**New Inner Tracking
Detector (ITk)**
All silicon, up to $|\eta| = 4$

Upgraded Trigger and Data Acquisition system

Level-0 Trigger at 1 MHz
Improved High-Level Trigger
(150 kHz full-scan tracking)

Electronics Upgrades

LAr Calorimeter
Tile Calorimeter
Muon system

High Granularity Timing Detector (HGTD)

Forward region ($2.4 < |\eta| < 4.0$) Low-Gain Avalanche
Detectors (LGAD) with 30 ps
track resolution

Additional small upgrades

Luminosity detectors (1%
precision goal) HL-ZDC



The CMS Phase 2 Upgrade

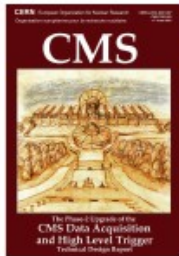
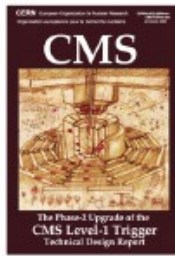

L1-Trigger HLT/DAQ

<https://cds.cern.ch/record/2714892>

<https://cds.cern.ch/record/2759072>

- Tracks in L1-Trigger at 40 MHz
- PFlow selection 750 kHz L1 output
- HLT output 7.5 kHz
- 40 MHz data scouting

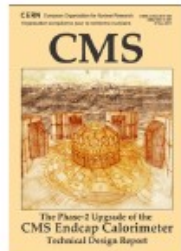

Calorimeter Endcap

<https://cds.cern.ch/record/2293646>

- 3D showers and precise timing
- Si, Scint+SiPM in Pb/W-SS

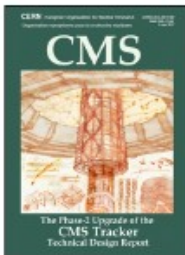

Tracker <https://cds.cern.ch/record/2272264>

- Si-Strip and Pixels increased granularity
- Design for tracking in L1-Trigger
- Extended coverage to $\eta \approx 3.8$

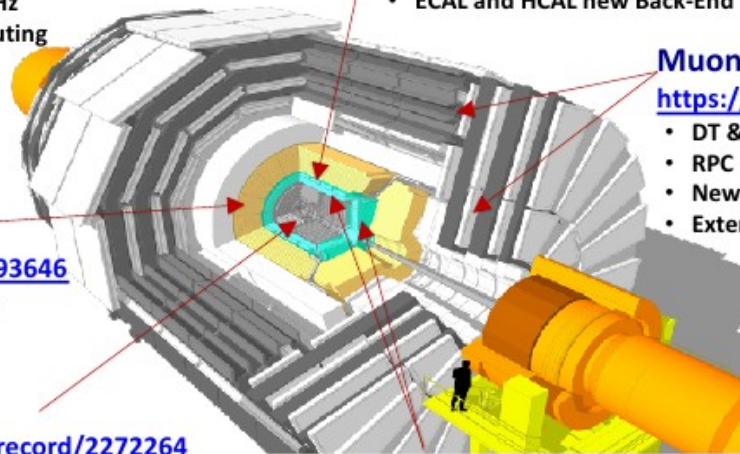

Barrel Calorimeters

<https://cds.cern.ch/record/2283187>

- ECAL crystal granularity readout at 40 MHz with precise timing for e/γ at 30 GeV
- ECAL and HCAL new Back-End boards

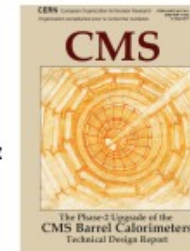

Muon systems

<https://cds.cern.ch/record/2283189>

- DT & CSC new FE/BE readout
- RPC back-end electronics
- New GEM/RPC $1.6 < \eta < 2.4$
- Extended coverage to $\eta \approx 3$



Beam Radiation Instr. and Luminosity

<http://cds.cern.ch/record/2759074>

- Bunch-by-bunch luminosity measurement: 1% offline, 2% online

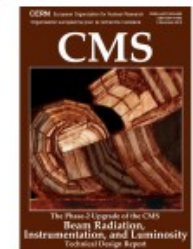

MIP Timing Detector

<https://cds.cern.ch/record/2667167>

Precision timing with:

- Barrel layer: Crystals + SiPMs
- Endcap layer: Low Gain Avalanche Diodes

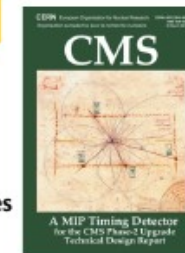

FCC-ee Detector Concepts Fast Overview

CLD

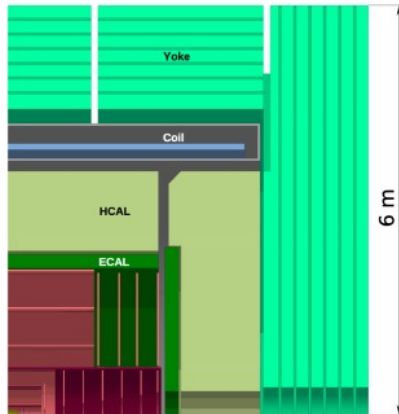

IDEA

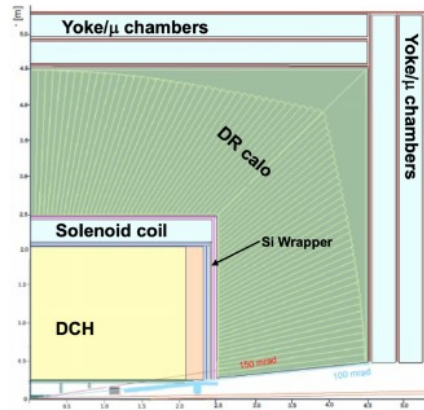

Noble-Liquid ECAL based

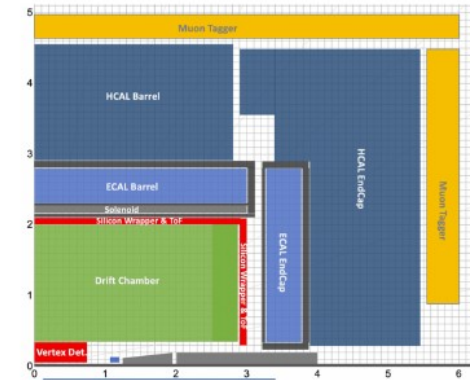

new

Conceptually extended from CLIC detector design

- Full silicon tracker
- High granularity silicon-tungsten ECAL
- High granularity scintillator-steel HCAL
- Instrumented return-yoke for muon detection
- Large 2 T coil surrounding calorimeter system

Engineering needed for adaptation to continuous beam operation (no power pulsing)

- Cooling of Si-sensors & calorimeters

Possible detector optimisations

- Improved ECAL and momentum resolutions
- Particle identification (TOF and/or RICH)

Specifically designed for FCC-ee (and CEPC)

- Silicon vertex detector
- Low X_0 drift chamber with high-resolution particle ID via ionisation measurement
- Silicon wrapper around drift chamber
- Light, thin 2T coil inside calorimeter system
- Pre-shower detector based on MPGC
- Dual-readout calorimeter; copper-scintillating/Cherenkov fibres
- Instrumented yoke with MPGC muon system

Possible detector optimisation

- Much improved EM energy resolution via crystal ECAL in front of coil

Specifically designed for FCC-ee, recent concept, under development

- Silicon vertex detector
- Low X_0 drift chamber with high-resolution particle ID via ionisation measurement
- Light, thin 2T coil inside same cryostat as ECAL
- High granularity Lead/Noble Liquid (LAR, possibly LKr) ECAL
- HCAL and muon systems to be specified

FCC-hh reference detector layout

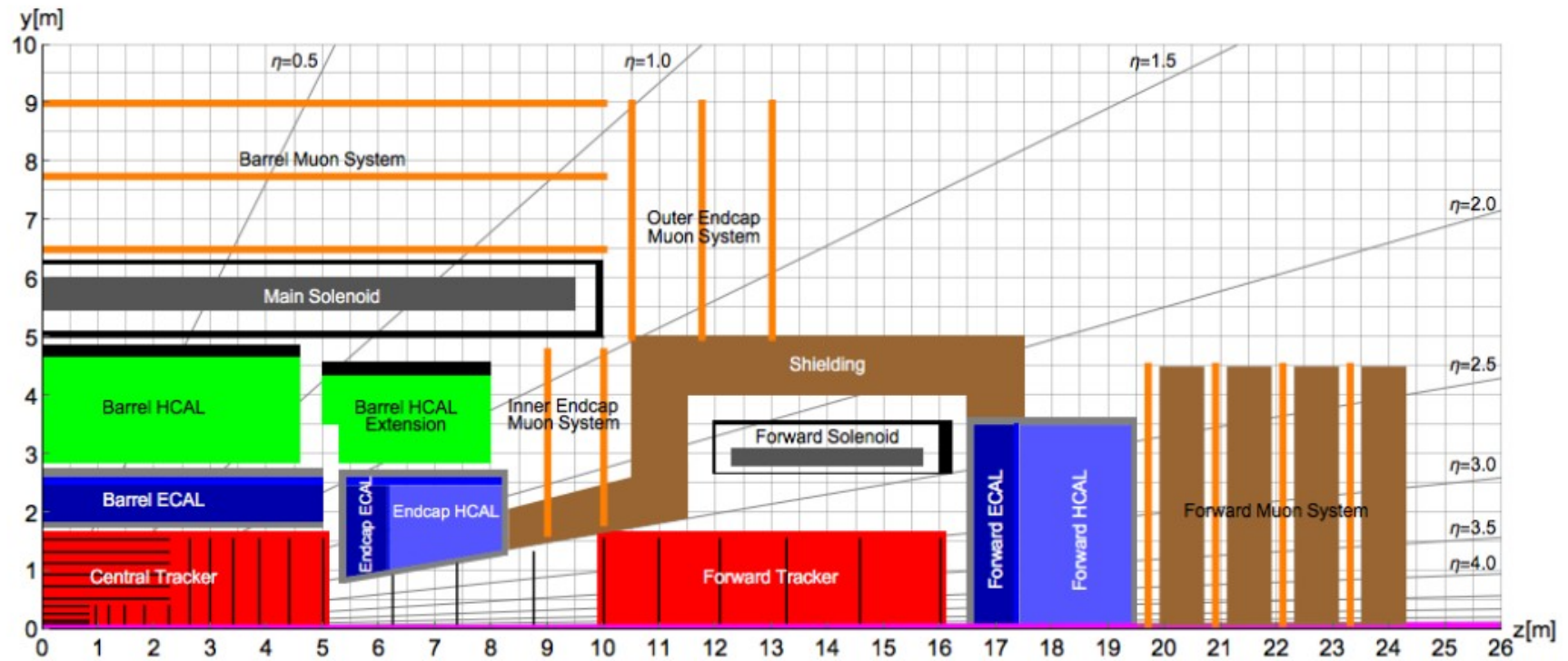

- 50 m long, 20 m diameter
- cavern length 66 m
- L^* of FCC 40 m

Speaker upgrades

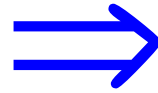

J. Bracinik

Warwick week, April 2023

Conclusions

- Expected physics at TeV scale to large extent defines architecture of high P_T detectors
- Still, where possible, CMS and ATLAS took different design decisions, leading to rather different detectors

Slides that weren't good enough
to make it into the talk ...

LHC clock distribution

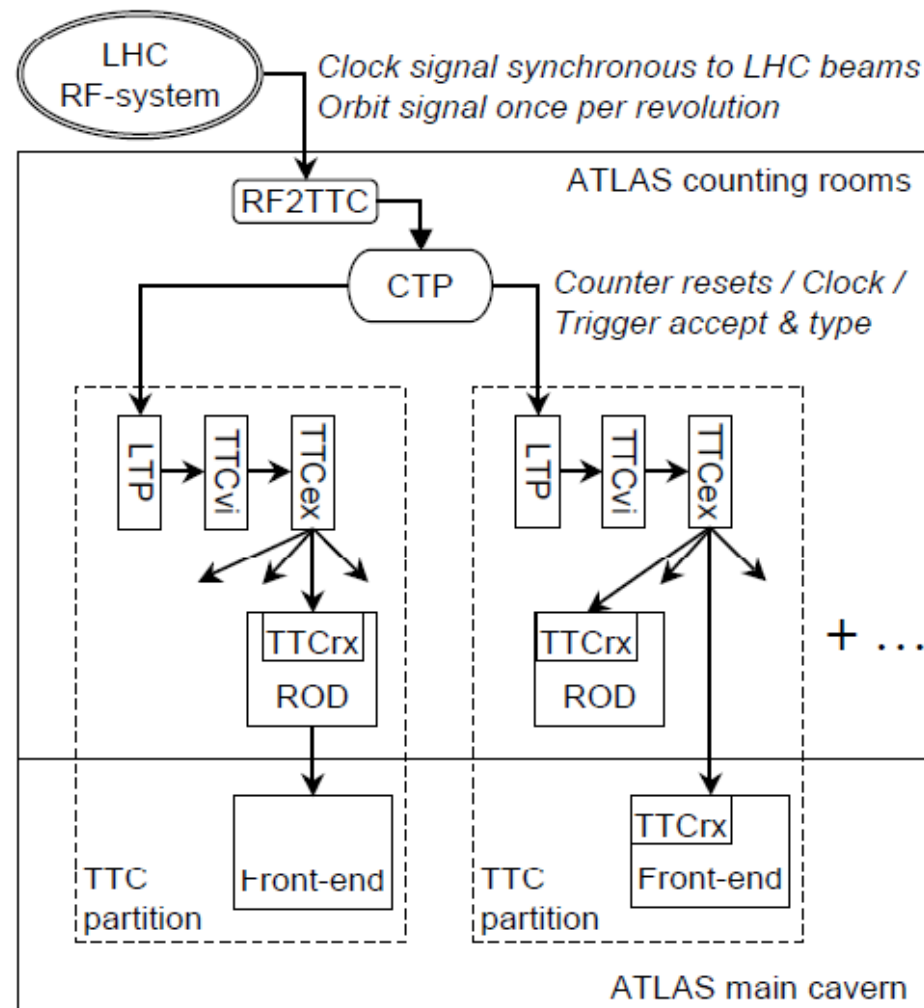

L1 calorimeter Trigger - CMS vs Atlas

ATLAS

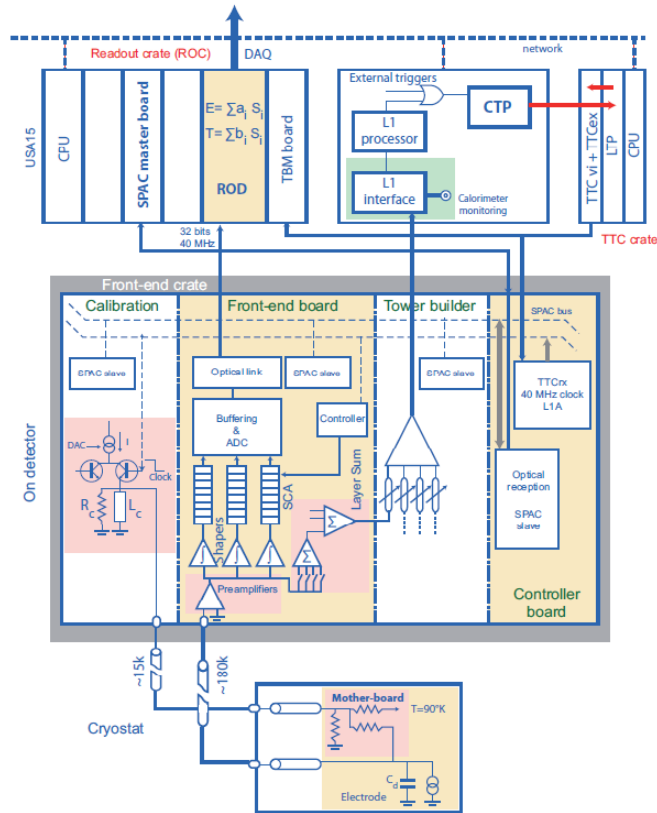

CMS

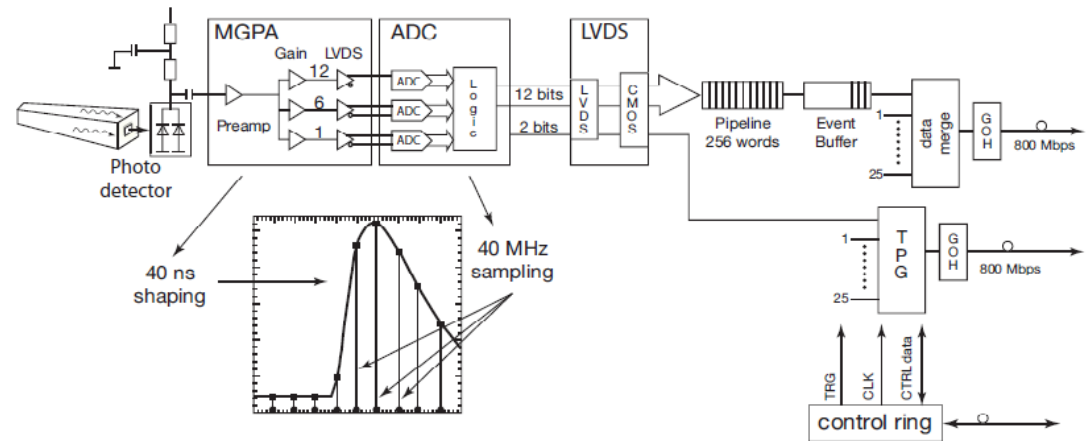

- ◆ Details of implementation are very different, this is an example of calorimeter front-end boards ...

- Performance aspects

- Physics events acceptance - critical to measure rare processes:

- Need improved trigger: increased bandwidth - precision of inputs - sophisticated algorithms

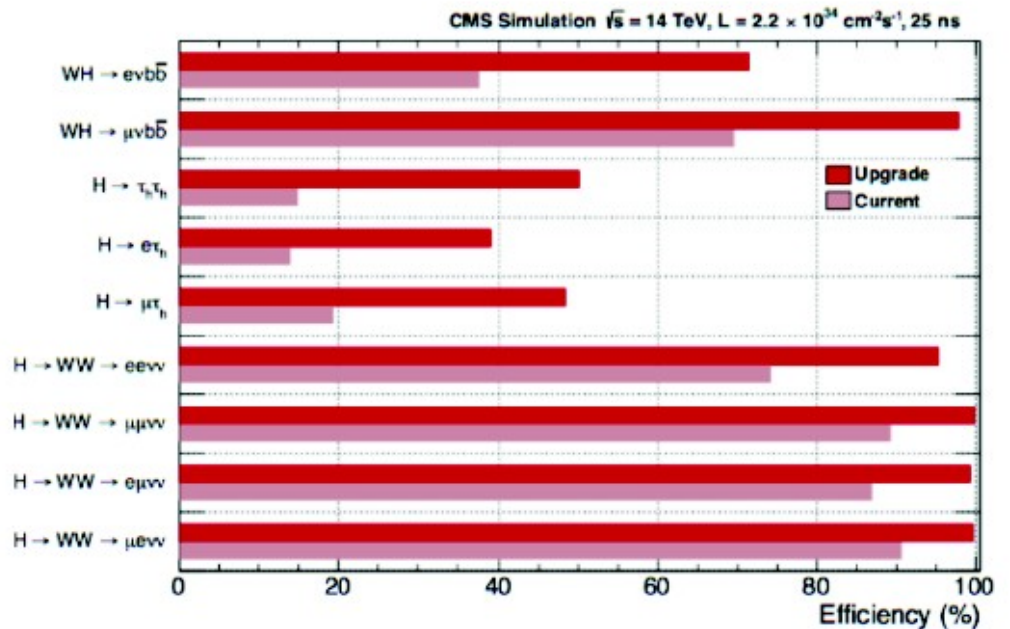
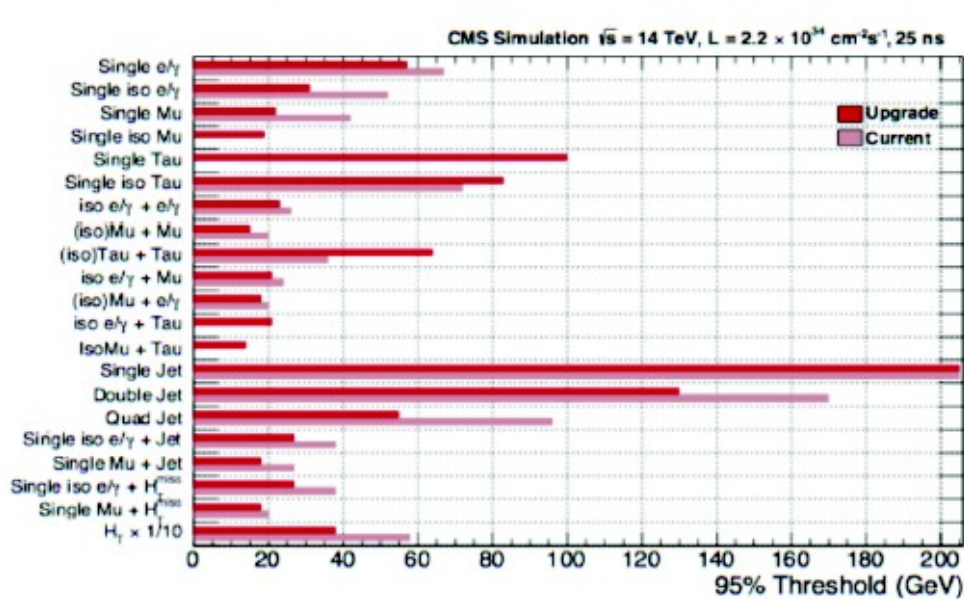

Example of the thresholds improvements with the CMS hardware trigger level upgrade for 50 PU (Phase 1) and impact on physics channel acceptance

➔ These levels of thresholds must be maintained at HL-LHC despite rate and PU increase

Physics Studies at Aix-les-Bains

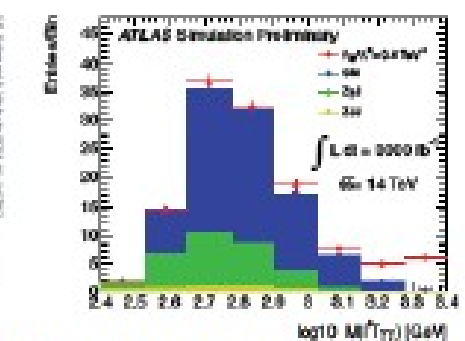
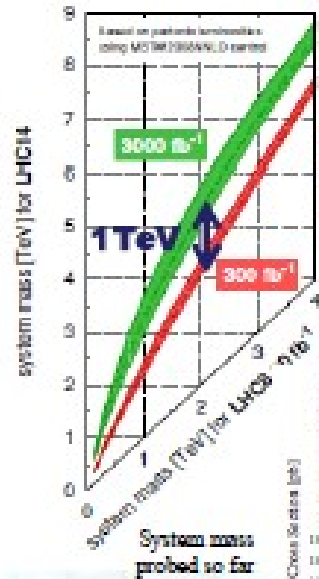
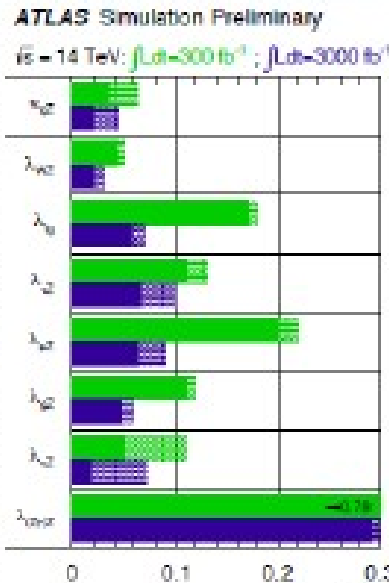
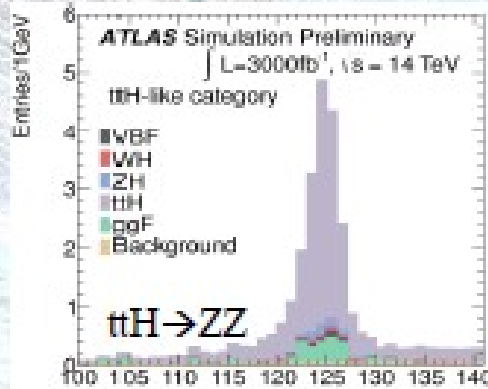

Vector boson anomalous couplings

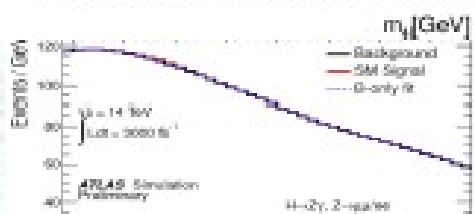
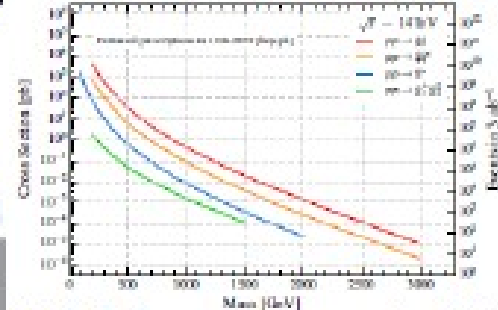

Improvements in coupling ratios with HL-LHC.
 (Range depends on handling of systematics and theoretical uncertainties)

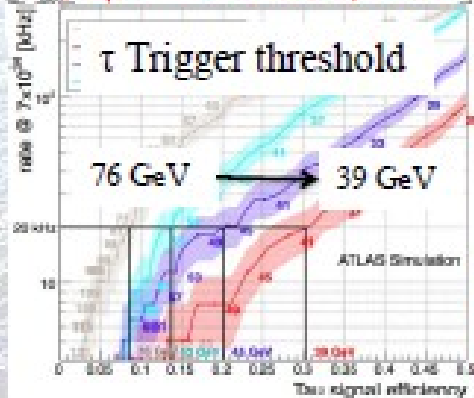
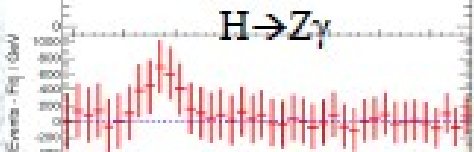

$H \rightarrow \tau\tau$ trigger threshold improvements with track trigger at L1

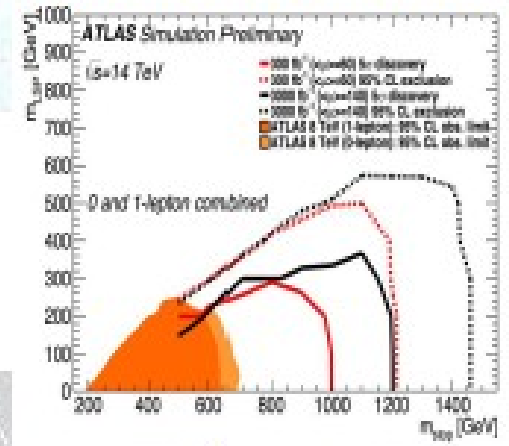
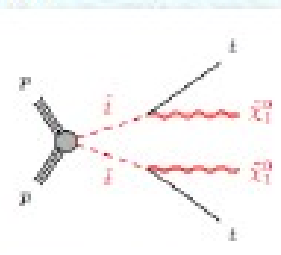

Schedule

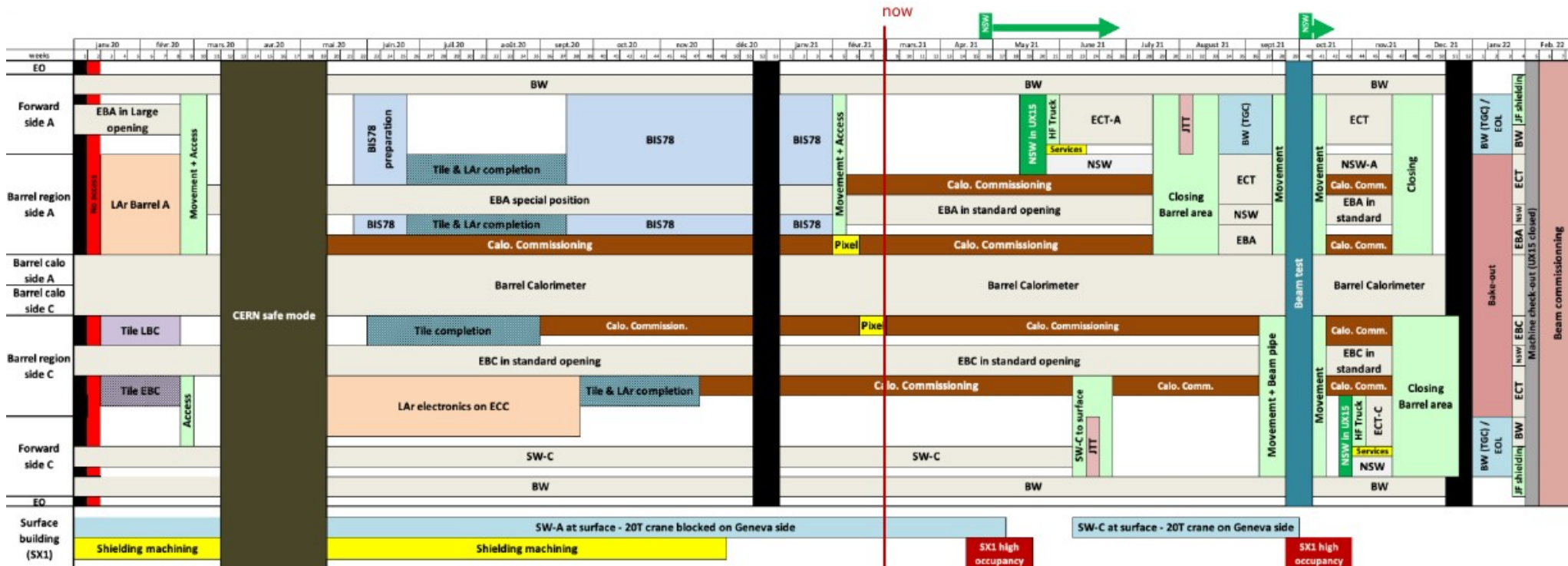

- LS2 maintenance work proceeding well on all detector systems, no major delays.
- Greatest effort to enable the installation of both New Small Wheels in 2021.
- Pilot beam is now scheduled for weeks 39+40:
 - Aperture measurement by the machine, exercise in preparation for 2022 (ramp?), collisions at injection energy in the experiments?
- Complex endgame (closing finished end of December, then beampipe bakeout).

ATLAS Phase 2 Tracker Upgrades

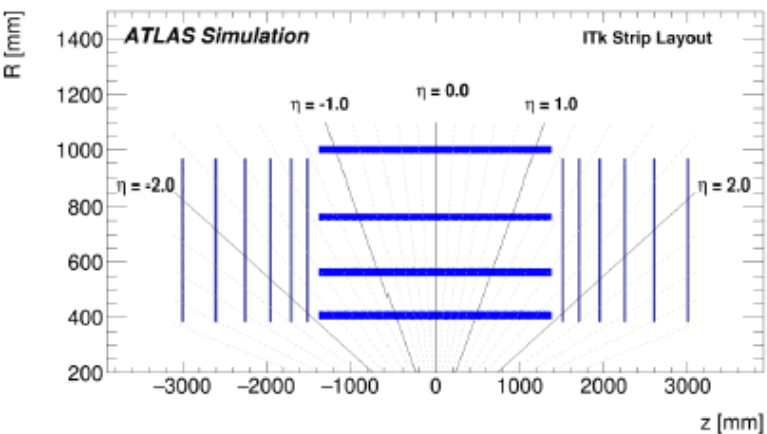
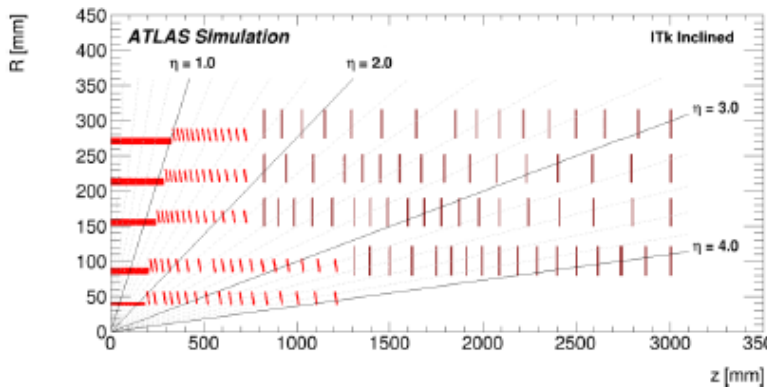

- **The Pixel detector** consists of five barrel layers with inclined sensors starting from $|\eta| > 1.0$
 - ◀ Reduces the material traverse by particles and improves tracking performance (and energy measurements of the calorimeter)
 - ◀ Less silicon surface than a traditional barrel needed to cover the same detector volume
 - ◀ Endcap rings replacing traditional disks to improve the coverage and at cost of less silicon surface
 - ◀ Two pixel pitches still under consideration 50×50 or $25 \times 100 \mu\text{m}^2$ - current ID using 50×250 (400) μm^2
 - ◀ All results presented are using $50 \times 50 \mu\text{m}^2$
- **The Strip detector** consist of four strip barrel layers with and six endcap disks on each side of the barrel
 - ◀ Covering up to $|\eta| < 2.6$
 - ◀ Modules at a stereo angle of 52(40) mrad for barrel (disks) to provide two dimensional measurements

Phase 2 upgrades of ATLAS trigger

- ◆ Keep one HW and one SW level architecture
- ◆ Both levels see changes!

Hardware level:

- ➔ Changes name (L1 to L0 :-)
- ◆ New Global trigger processor
 - ➔ Time multiplexed architecture
- ◆ (possible) new Timing Detector (High Granularity Timing Detector, HGTD)
- ◆ Muon Drift Tube (MDT) information added to trigger
- ◆ New Resistive plate chambers in the barrel to improve muon triggering

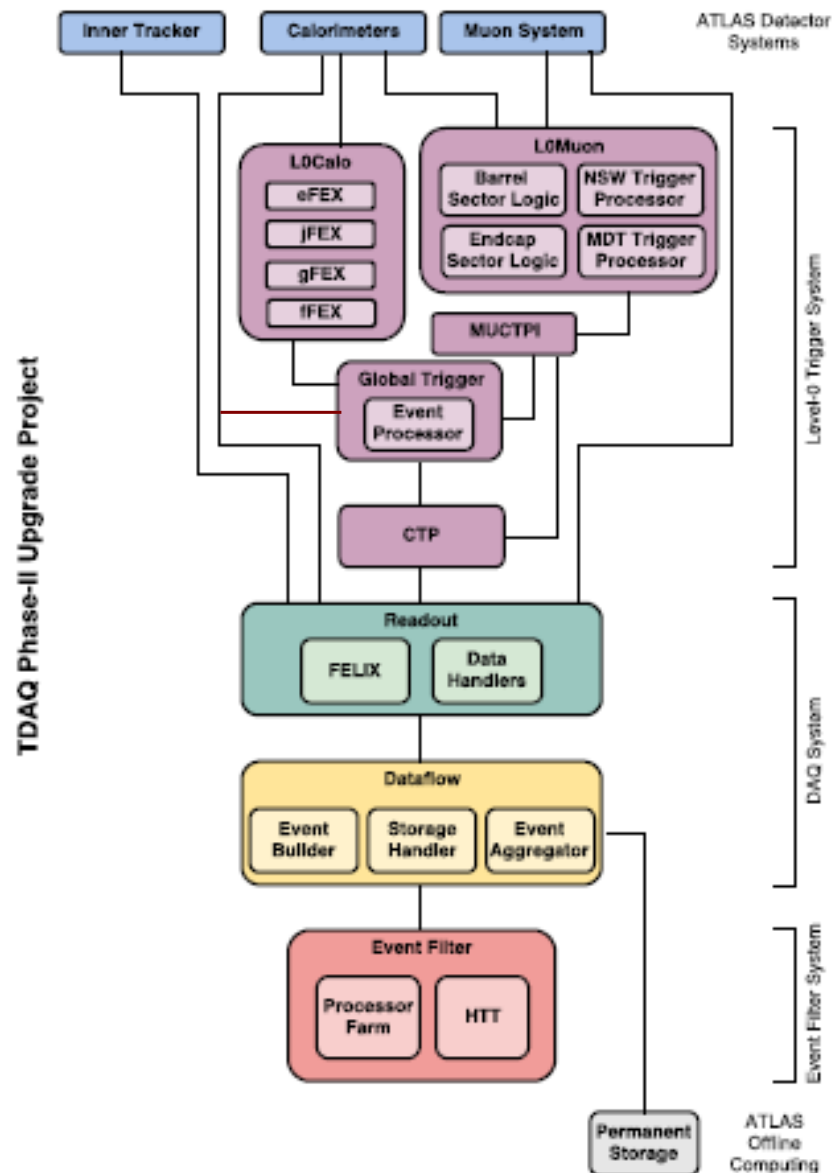

ATLAS Phase 2 Upgrades of Calorimeters

Phase-II Liquid Argon Upgrade

- ATLAS Liquid Argon (LAr) Calorimeters
 - ◀ EM calorimeter $|\eta| < 3.2$
 - ◀ Hadronic calorimeter for $1.5 < |\eta| < 4.9$
- Calorimeters expected to fully operational at HL-LHC
- *For HL-LHC* a total replacement of the electronic readouts and low voltage powering is planned
- Main motivations for the upgrade
 - ◀ Required by restricted radiation tolerance of current front-ends
 - ◀ Present readout system will be incompatible with the planned upgrade of the ATLAS trigger system
 - ◀ Necessary to avoid degradation of performance in high pile-up environment
 - ◀ Allows for partial suppression of out-of-time pile-up effects
- New readout architecture more acquiescent
 - ◀ Will allow for higher resolution information of the calorimeters to be available at the lowest level of the trigger system
- This yields enhanced capabilities to develop trigger algorithms to benefit *physics!*

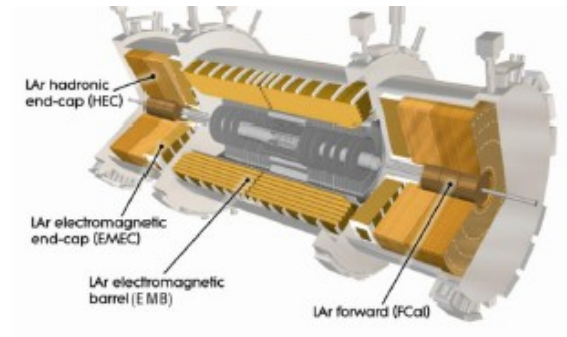



CMS LS2 Program

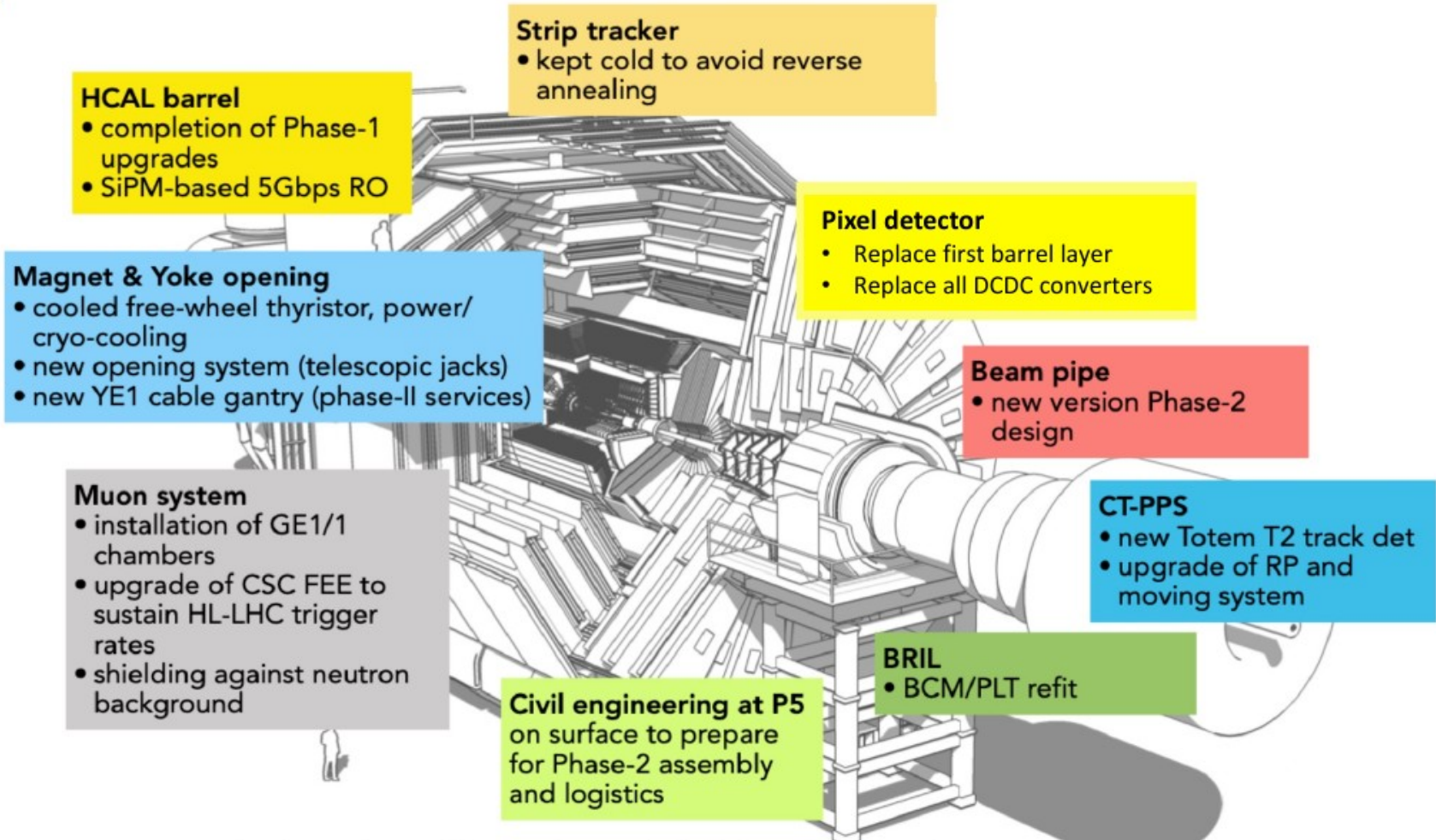

LHC plans for (almost) near future

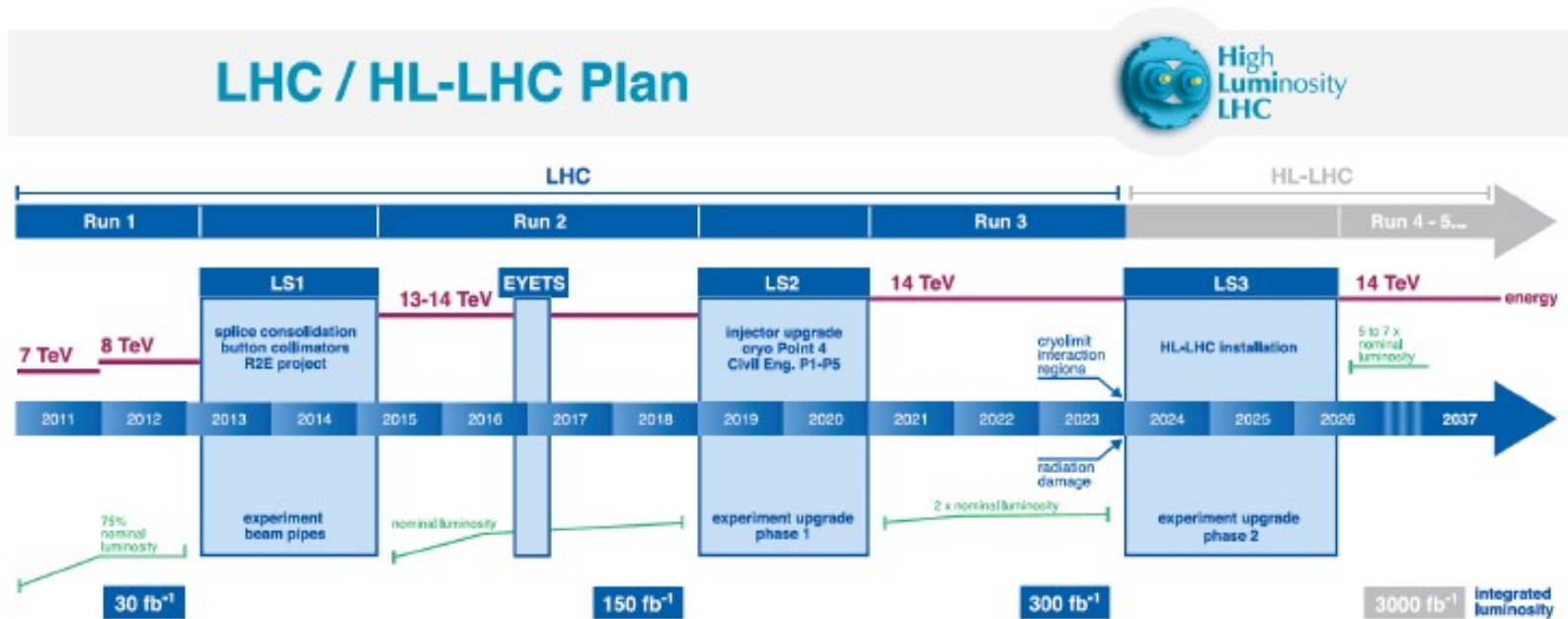

Run-1 (2010-2012)

- $\sqrt{s} = 7 (8) \text{ TeV}$
- 50 ns bunch spacing
- $L_{\text{int}} \sim 30 \text{ fb}^{-1}$
- $L_{\text{peak}} \sim 7.5 \cdot 10^{33} \text{ cm}^{-2} \text{ s}^{-1}$
- $\langle \mu \rangle \sim 30$

Run-2 (2015-2018)

- $\sqrt{s} = 13 (14) \text{ TeV}$
- 25 ns bunch spacing
- $L_{\text{int}} \sim 100 - 150 \text{ fb}^{-1}$
- $L_{\text{peak}} \sim 1.3-1.5 \cdot 10^{34} \text{ cm}^{-2} \text{ s}^{-1}$
- $\langle \mu \rangle \sim 40$

Run-3 (2021-2023)

- $\sqrt{s} = 14 \text{ TeV}$
- 25 ns bunch spacing
- $L_{\text{int}} \sim 300 \text{ fb}^{-1}$
- $L_{\text{peak}} \sim 2 \cdot 10^{34} \text{ cm}^{-2} \text{ s}^{-1}$
- $\langle \mu \rangle \sim 60$

CMS Phase 2 Upgrades

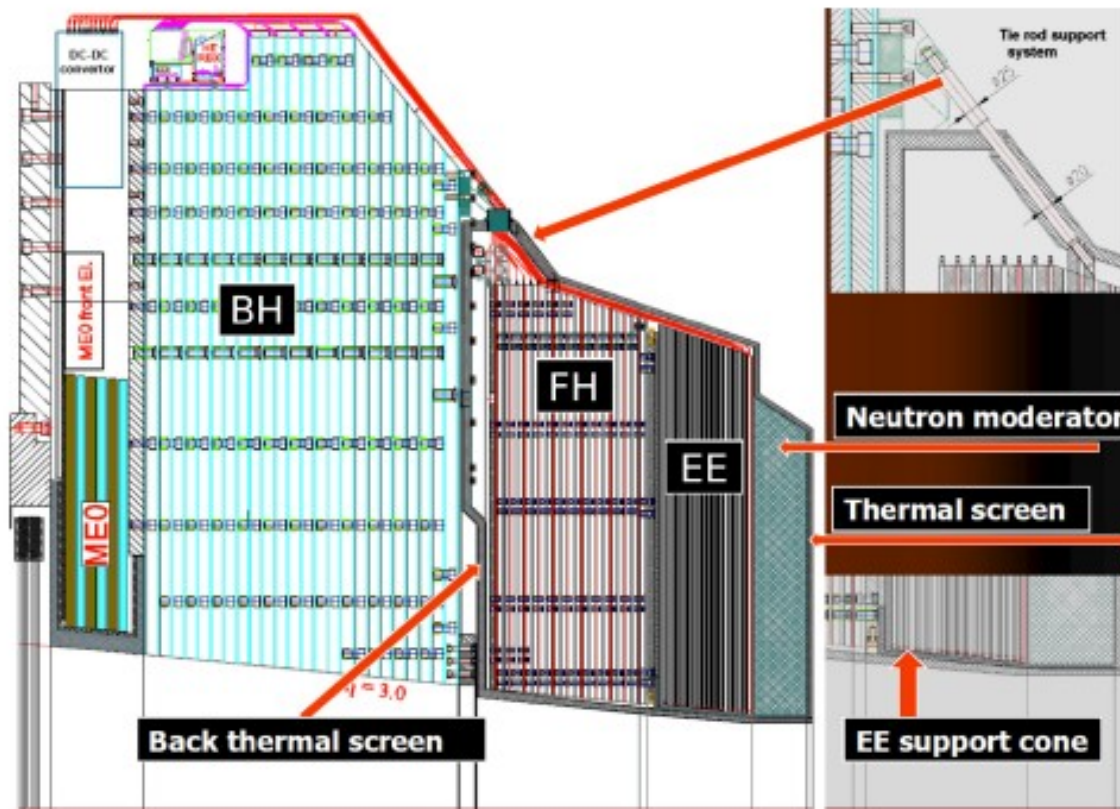

- Entirely new endcap calorimeter: High granularity silicon detector with tungsten/brass absorber in EE/FH
- Plastic scintillator and brass absorber for back hadronic section

CMS Phase 2 Upgrades -L1 Track Trigger

- Outer tracker provides hardware trigger capabilities
- Readout of full detector at 40 MHz is not feasible $\rightarrow p_T$ modules with two closely spaced sensors provide a **local** p_T measurement, and allow on-detector application of p_T thresholds for hardware trigger
- Hardware trigger receives track stubs with $p_T > 2$ GeV \rightarrow 10-100x reduction in data-volume
- Coverage up to $|\eta| = 2.4$

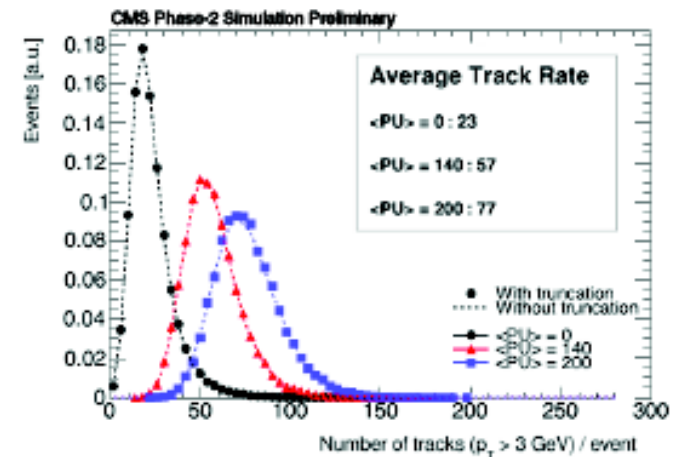
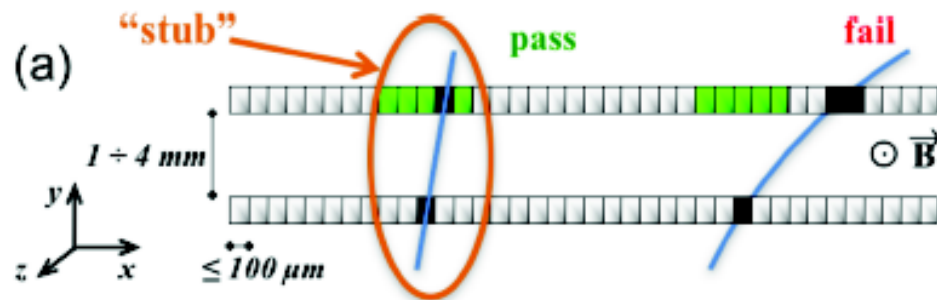

ATLAS Phase 1 Upgrades

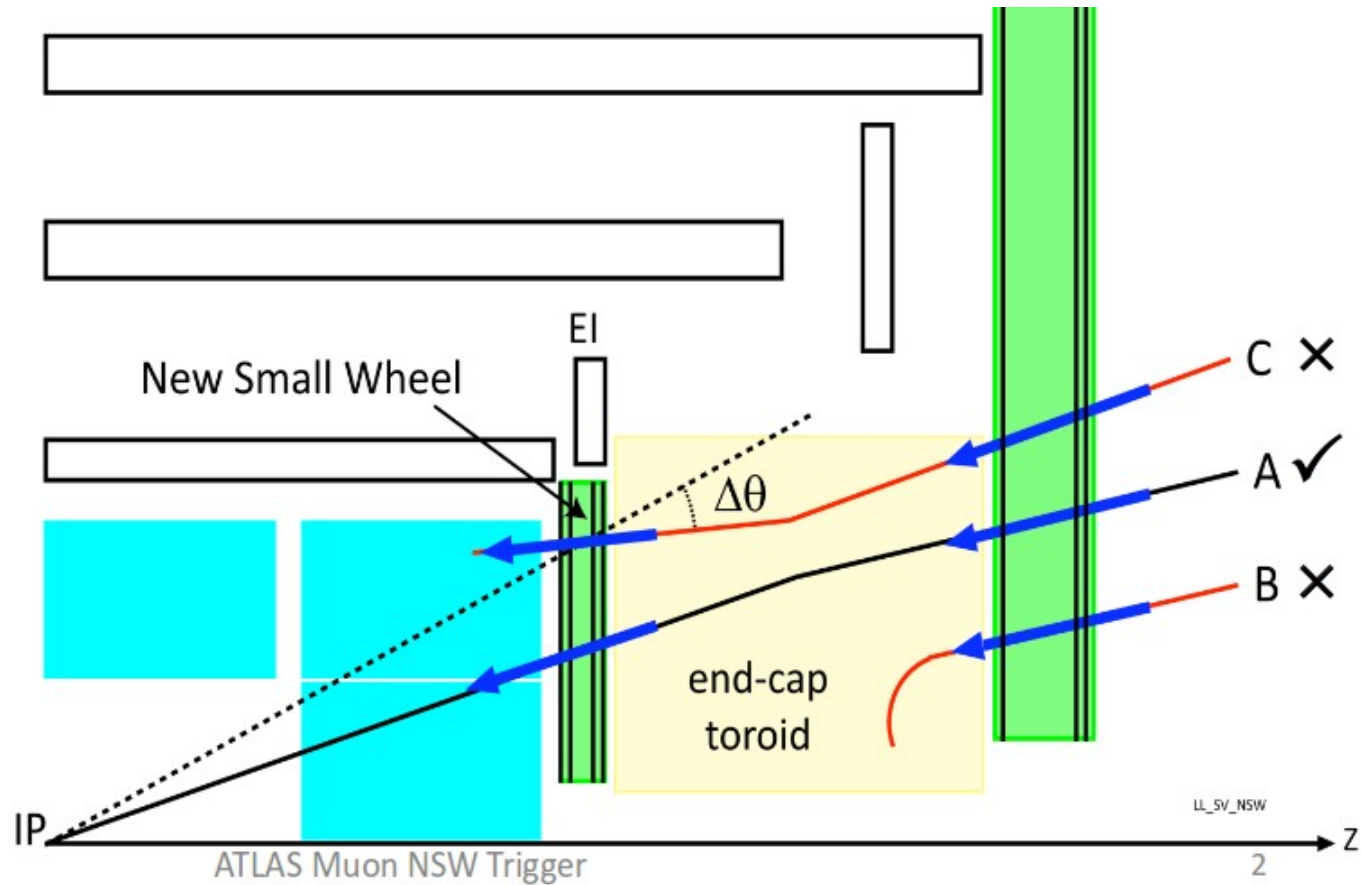

Several upgrades (many of them in triggering area):

- ◆ New Small Muon Wheels
- ◆ Fast Tracker (FTK) **Cancelled!**
- ◆ LAr electronics
- ◆ New L1 Calorimeter trigger processors