

NEUTRINO PHYSICS

A large, complex, multi-layered detector structure, likely a neutrino detector, with many small, glowing components and a central, bright, multi-armed structure. The structure is composed of numerous small, glowing components, possibly photomultiplier tubes or scintillators, arranged in a circular pattern around a central, multi-armed structure. The overall appearance is that of a highly sophisticated and intricate scientific instrument.

Steve Boyd

Online lectures

- ▶ My plant has benefited from a year of online lectures. It's not looking too healthy (hmm - is there any connection? Surely not.)
- ▶ If you have a question during the lecture please use the raise-hand function
- ▶ At the beginning of every lecture, except the first, I'll have a Q&A session to answer more detailed questions which may have arisen during the previous day
- ▶ Please post questions to the neutrino channel on Slack! Others might have the same question, or it might spark a further discussion.
- ▶ I'll probably take a couple of 5 minutes breaks here and there during the lectures
- ▶ This is for coffee (or tea (or gin..er..water))



What's in the lectures

1. History and properties of the neutrino, neutrino interactions, beams and detectors
2. Neutrino mass, direct mass measurements, double beta decay, flavour oscillations
3. Unravelling neutrino oscillations experimentally
4. Where we are and where we're going

References

- K. Zuber, “Neutrino Physics”, IoP Publishing 2004
- **C. Giunti and C.W.Kim, “Fundamentals of Neutrino Physics and Astrophysics”, Oxford University Press, 2007.**
- V. Barger and D. Marfatia, “The Physics of Neutrinos”, Princeton University Press, 2012
- H.V. Klapdor-Kleingrothaus & K. Zuber, “Particle Astrophysics”, IoP Publishing, 1997.

- F. Close, “Neutrino”, 2012
- R. Jayawardhana, “The Neutrino Hunters”, 2014
- C. Sutton, “Spaceship Neutrino”, 2010

Lecture 1

In which history is unravelled, desperation is answered, and the art of neutrino generation and detection explained

Crisis

It is 1914 - the new study of atomic physics is in trouble

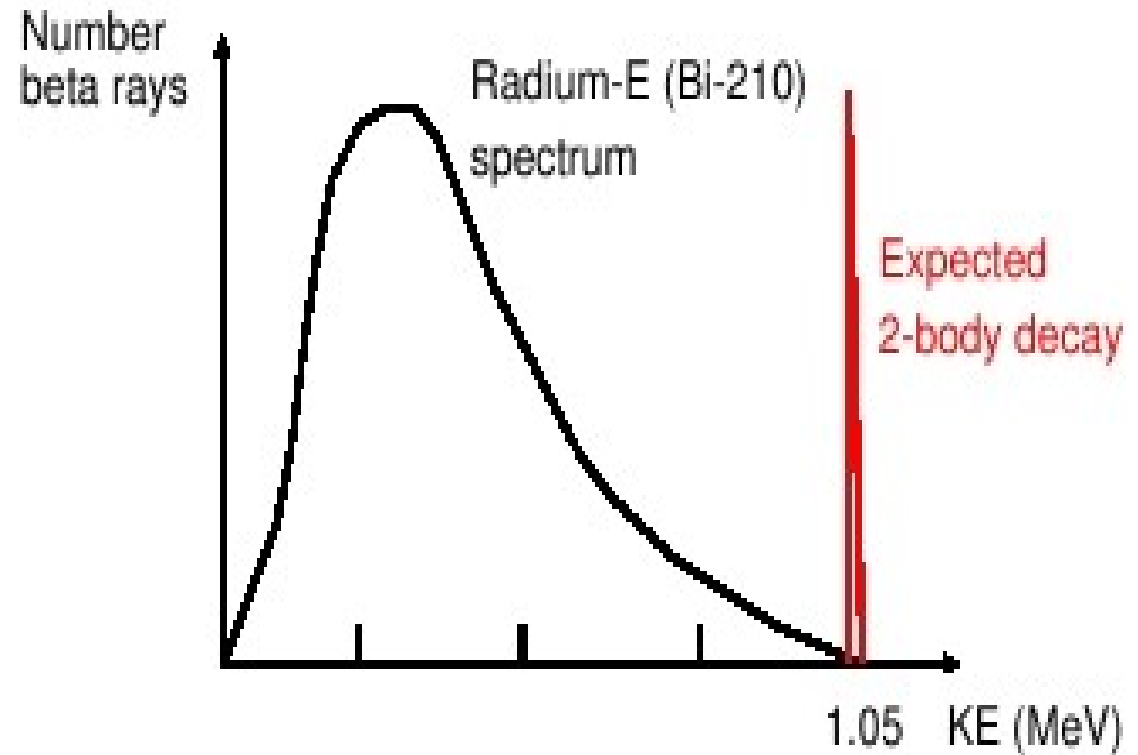
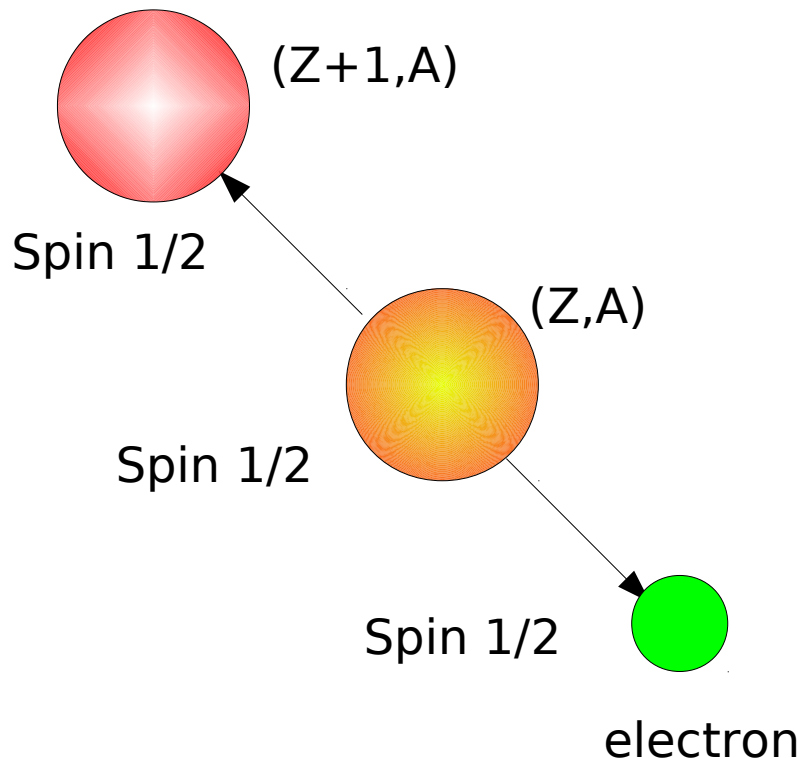

$$\text{Spin } \frac{1}{2} \neq \text{spin } \frac{1}{2} + \text{spin } \frac{1}{2}$$

$$E_{\text{Ra}} \neq E_{\text{Bi}} + e$$



“At the present stage of atomic theory we have no arguments for upholding the concept of energy balance in the case of β -ray disintegrations.”



“Desperate remedy.....”
“I do not dare publish this idea....”
“I admit my way out may look improbable....”
“Weigh it and pass sentence....”

“You tell them. I'm off to a party”

4th December 1930

Dear Radioactive Ladies and Gentlemen,

As the bearer of these lines, to whom I graciously ask you to listen, will explain to you in more detail, how because of the "wrong" statistics of the N and ${}^6\text{Li}$ nuclei and the continuous beta spectrum, *I have hit upon a desperate remedy to save the "exchange theorem" of statistics and the law of conservation of energy.* Namely, the possibility that *there could exist in the nuclei electrically neutral particles, that I wish to call **neutrons**, which have spin and obey the exclusion principle* and which further differ from light quanta in that they do not travel with the velocity of light. The *mass* of the neutrons *should be of the same order of magnitude as the electron mass* (and in any event not larger than 0.01 proton masses). The continuous beta spectrum would then become understandable by the assumption that in beta decay a neutron is emitted in addition to the electron such that the sum of the energies of the neutron and the electron is constant...

From now on, every solution to the issue must be discussed. Thus, dear radioactive people, look and judge. *Unfortunately I will not be able to appear in Tübingen personally, because I am indispensable here due to a ball which will take place in Zurich during the night from December 6 to 7...*

Your humble servant,
W. Pauli

Oh the pain

“I have done something very bad today by proposing a particle that cannot be detected. It is something that no theorist should ever do.”

Pauli, 1930

Detection of the Neutrino

1950 – Reines and Cowan set out to detect ν

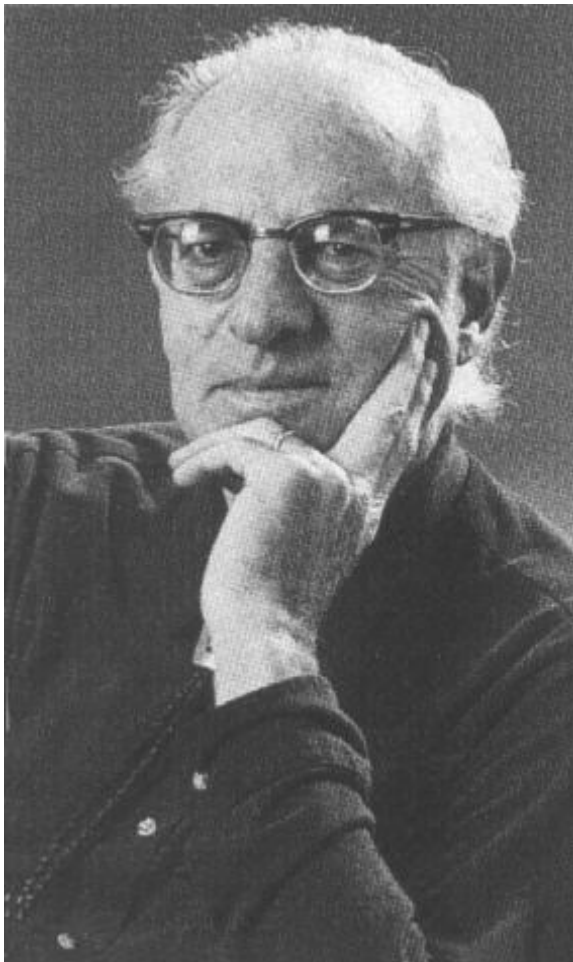

Detection of the Neutrino

1953-1956

The Reines-Cowan Experiments

Detecting the Poltergeist



Hanford Team 1953

Savannah Team 1955



The Hanford Team: (on facing page, left to right, back row) F. Newton Hayes, Captain W. A. Walker, T. J. White, Fred Reines, E. C. Anderson, Clyde Cowan, Jr., and Robert Schuch (inset); not all team members are pictured.

The Savannah River Team: (clockwise, from lower left foreground) Clyde Cowan, Jr., F. B. Harrison, Austin McGuire, Fred Reines, and Martin Warren; (left to right, front row) Richard Jones, Forrest Rice, and Herald Kruse.

In 1951, when Fred Reines first contemplated an experiment to detect the neutrino, this particle was still a poltergeist, a fleeting yet haunting ghost in the world of physical reality. All its properties had been deduced but only theoretically. Its role was to carry away the missing energy and angular momentum in nuclear beta

decay, the most familiar and widespread manifestation of what is now called the weak force. The neutrino surely had to exist. But someone had to demonstrate its reality. The relentless quest that led to the detection of the neutrino started with an energy crisis in the very young field of nuclear physics.

1951

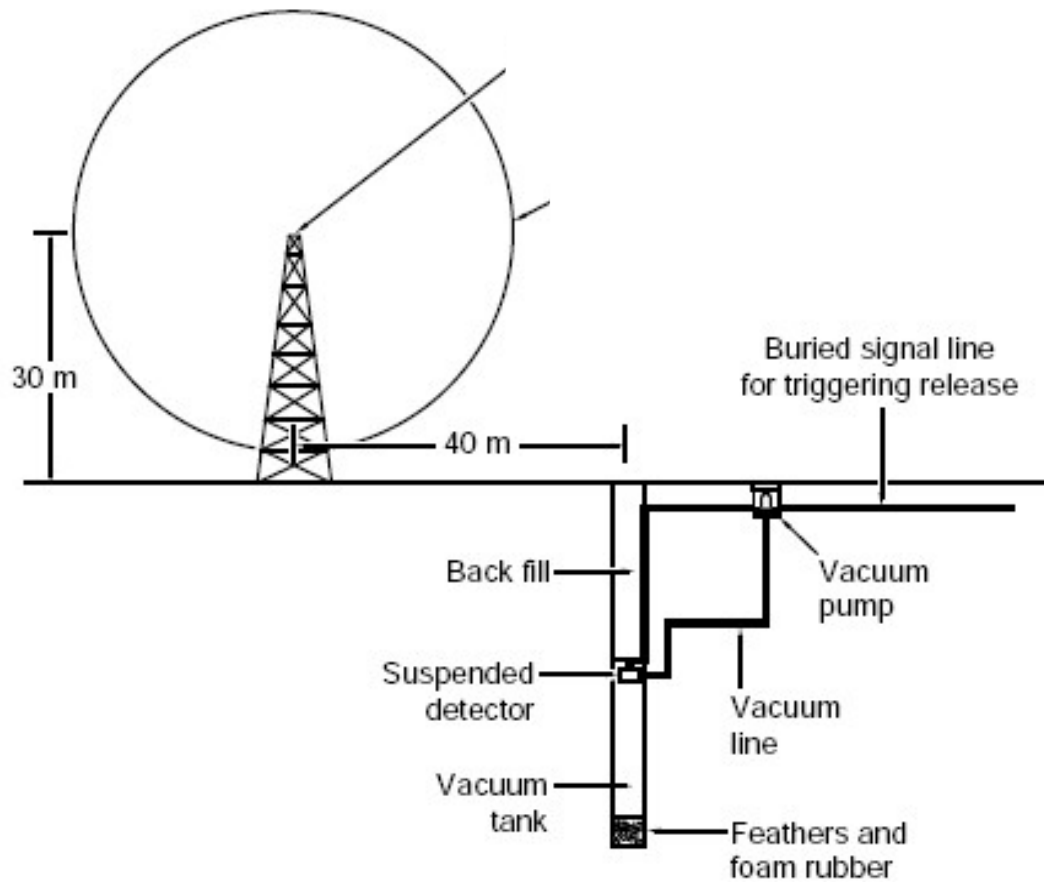

1951

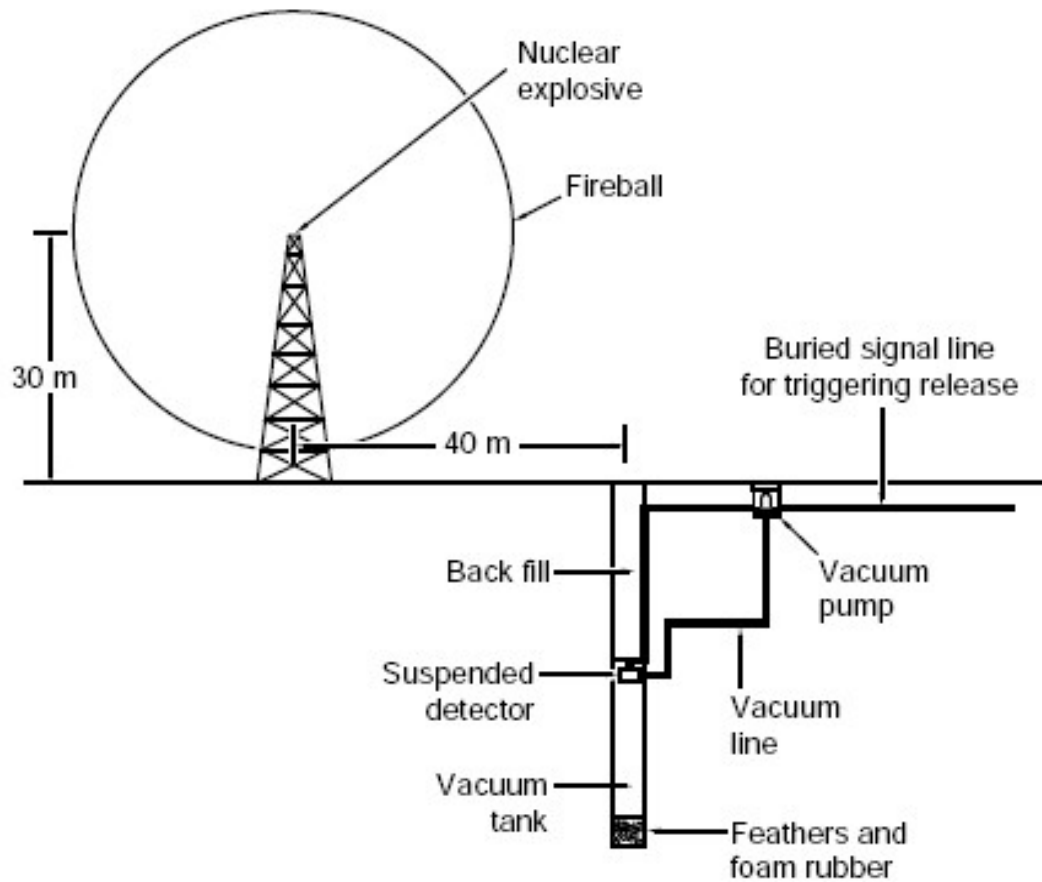

1951

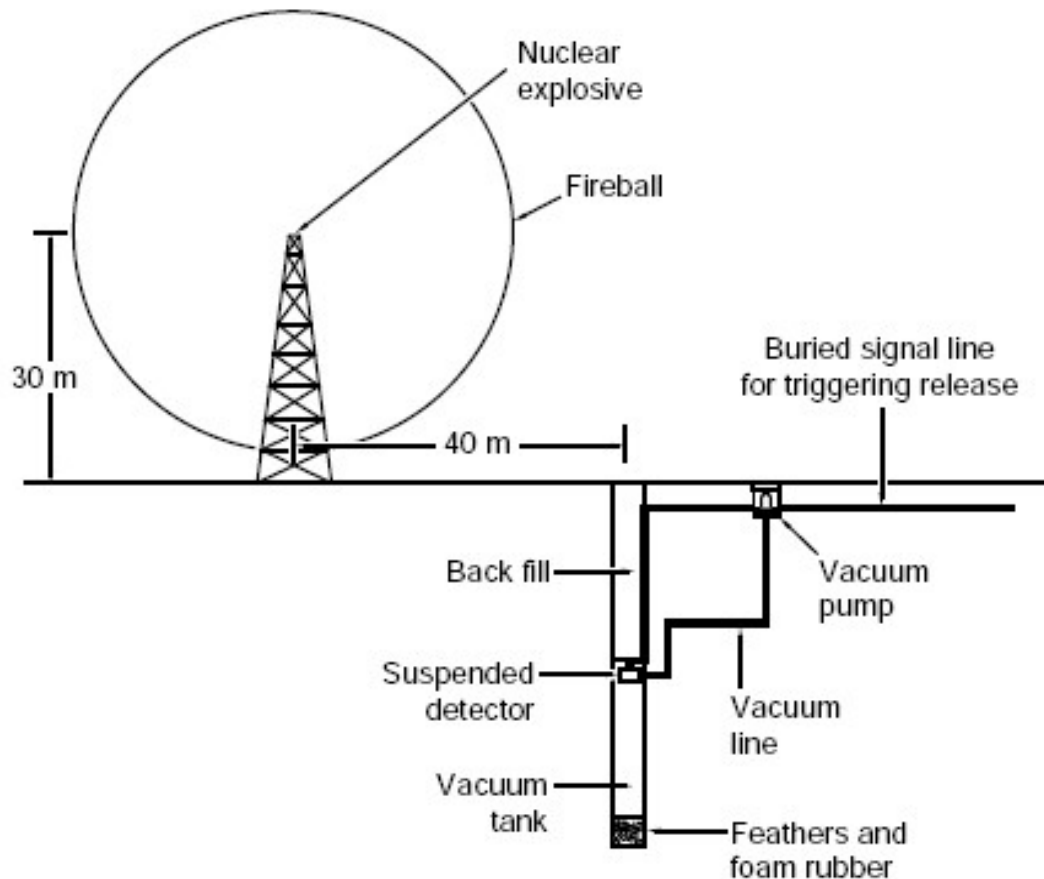

- I. Explode bomb
- II. At same time let detector fall in vacuum tank
- III. Detect neutrinos
- IV. Collect Nobel prize

OK - but repeatability is a bit of a problem

Idea Number 2 - 1955

A nuclear reactor is the next best thing

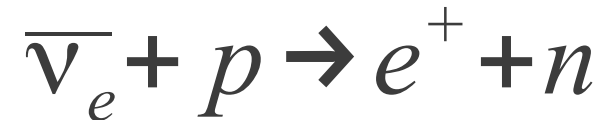

Positron Annihilation

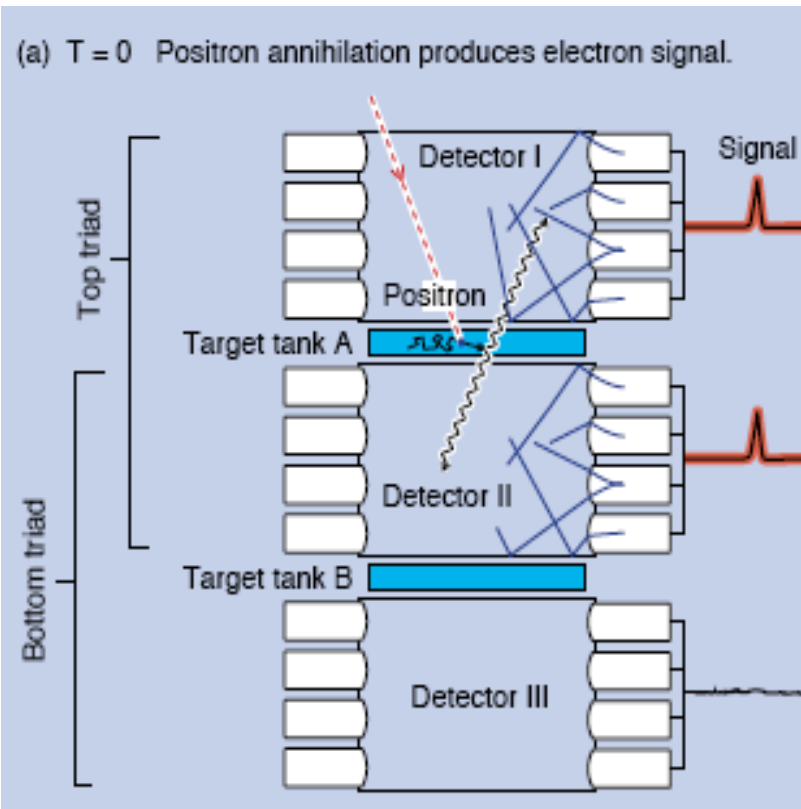

Neutron Capture

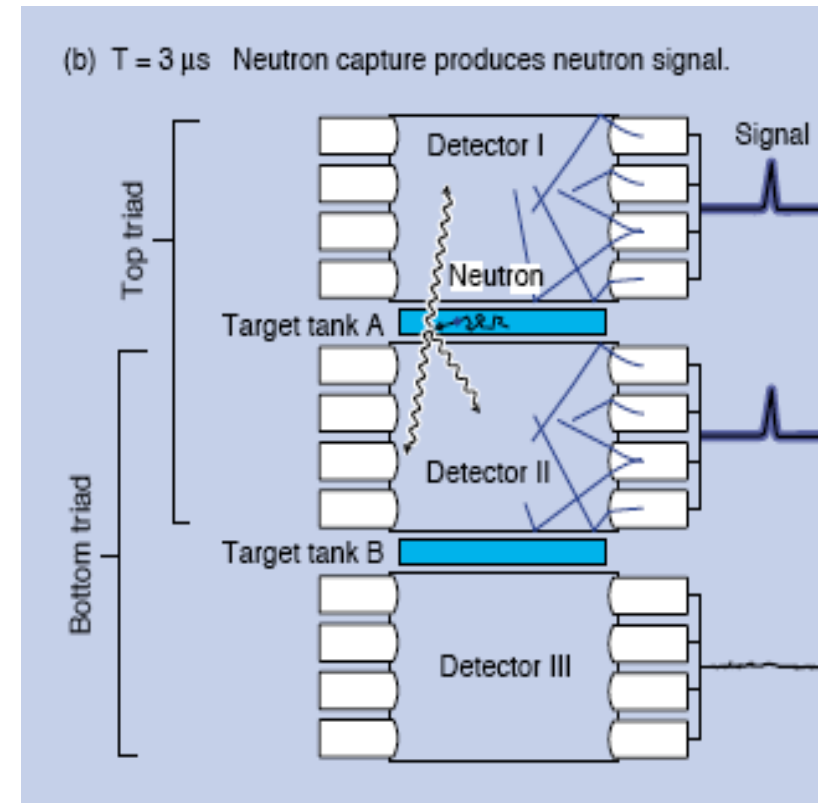

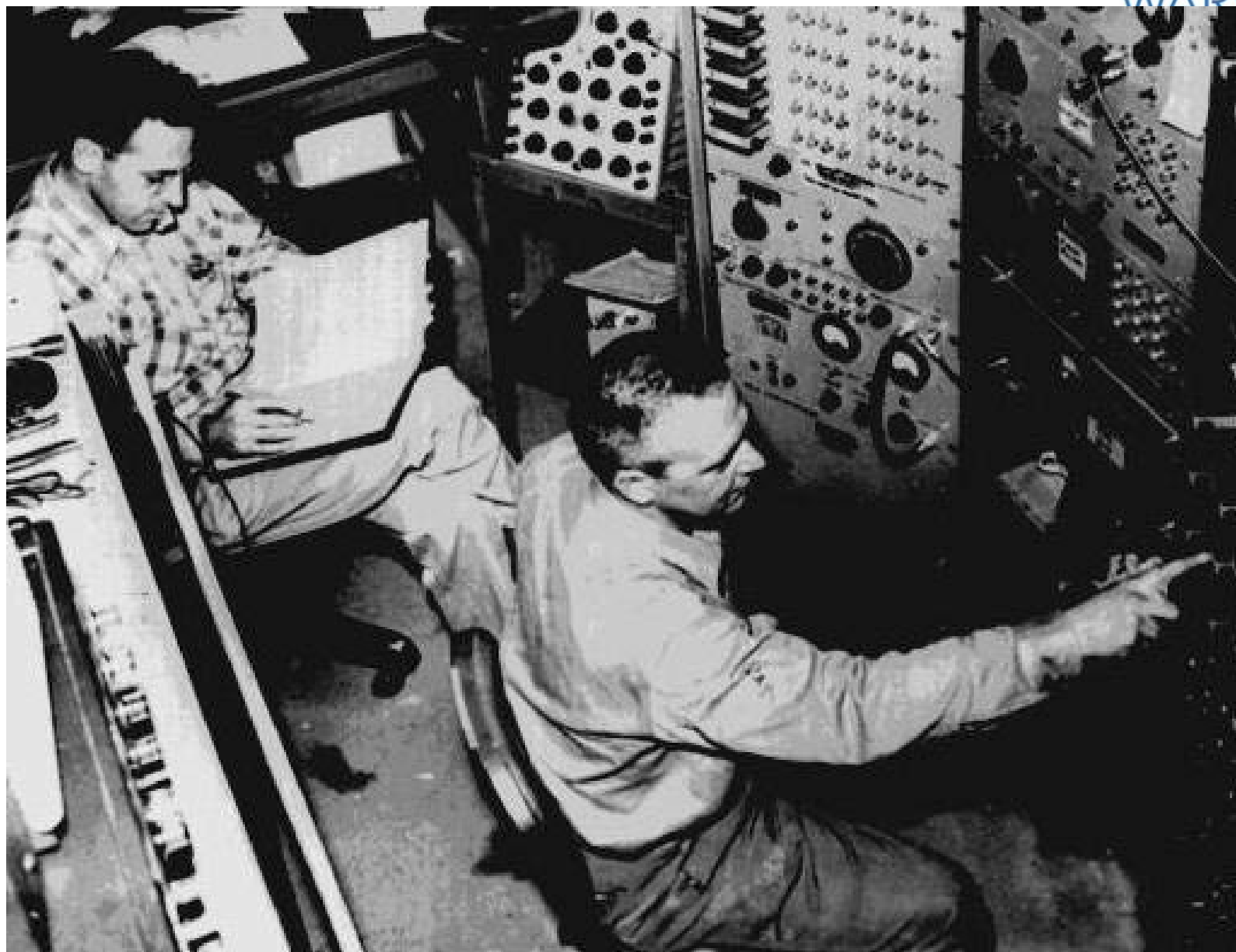

1959 – Savannah River Reactor

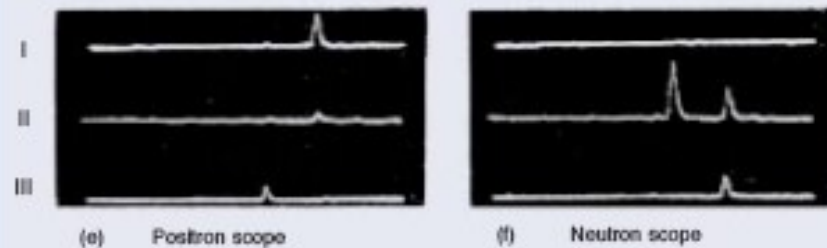
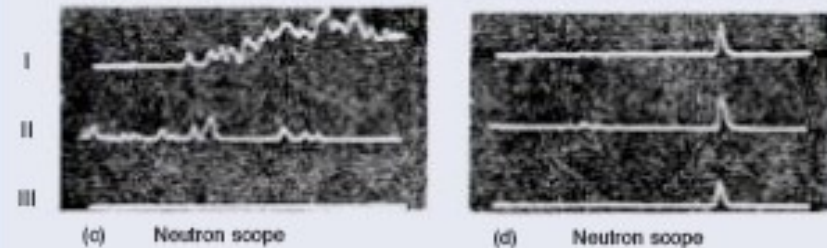
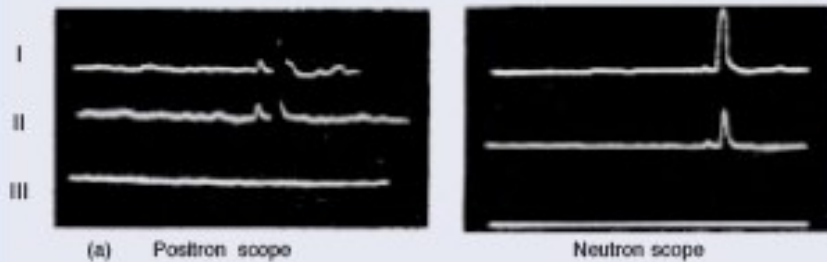

$$\text{ON} - \text{OFF} = 2.88 \pm 0.22 \text{ hr}^{-1}$$

$$\sigma = (11 \pm 2.6) \times 10^{-44} \text{ cm}^2$$

$$\sigma (\text{Pred}) = (5 \pm 1) \times 10^{-44} \text{ cm}^2$$

Neutrinos come in flavours!

Up to 1962, only the electron neutrino had been detected – and hence only the “neutrino” existed.

Suspensions were strong that more were out there

In 1962, Schwartz, Steinberger and Lederman presented evidence for the muon neutrino and built the very first neutrino beam!

A muon produced in a neutrino reaction gives rise to discharges observed in the spark chamber.

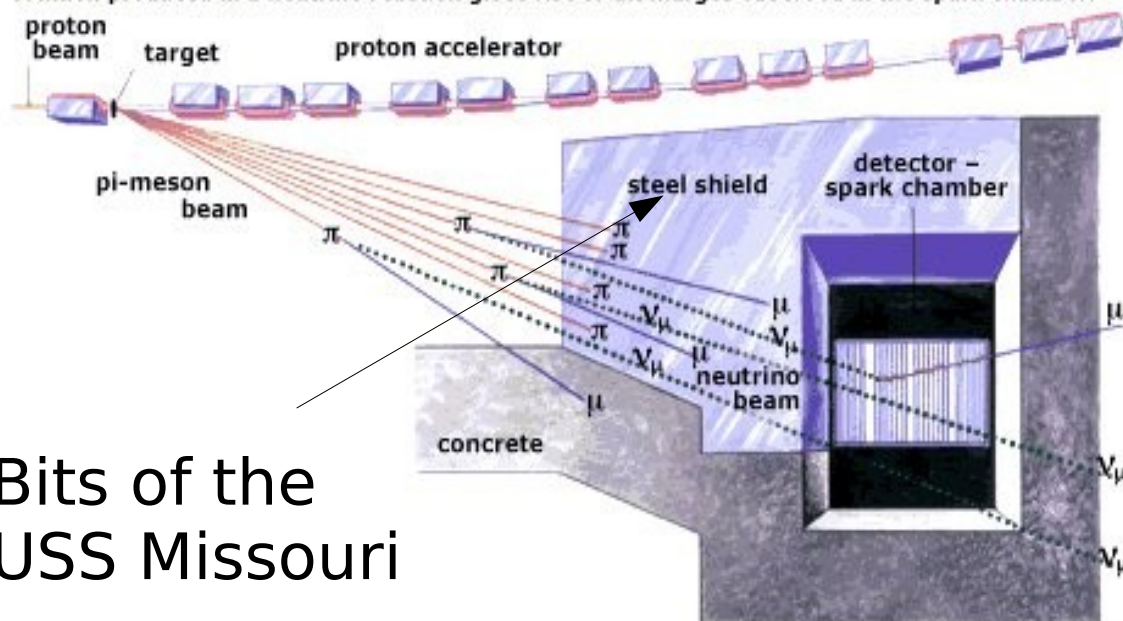

Bits of the
USS Missouri

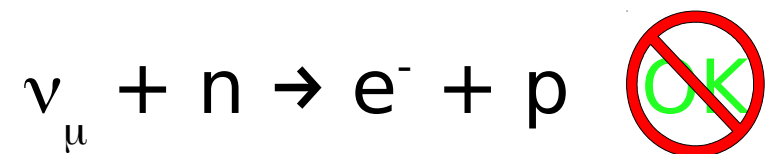
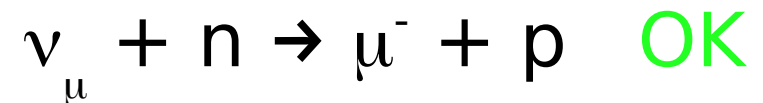
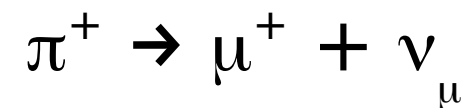

The State of Play pre-2000

Flavour	Mass (GeV/c ²)	Electric Charge
ν_e	$< 1 \times 10^{-8}$	0
electron	0.000511	-1
ν_μ	< 0.0002	0
muon	0.106	-1
	?	
tau	1.7771	-1

How many neutrinos do we expect to find?

The Number of light neutrinos

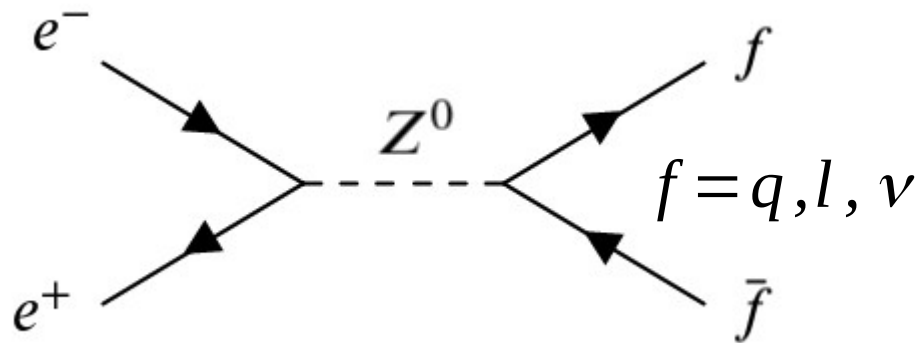

$$\Gamma_Z = \sum \Gamma_{q\bar{q}} + 3\Gamma_{l\bar{l}} + N_\nu \Gamma_{\nu\bar{\nu}}$$

Discovery of Z^0 allowed a measurement of the number of light neutrinos since the Z^0 can decay to a neutrino and antineutrino

NB Mass of $\nu < m_Z/2 \sim 46$ GeV

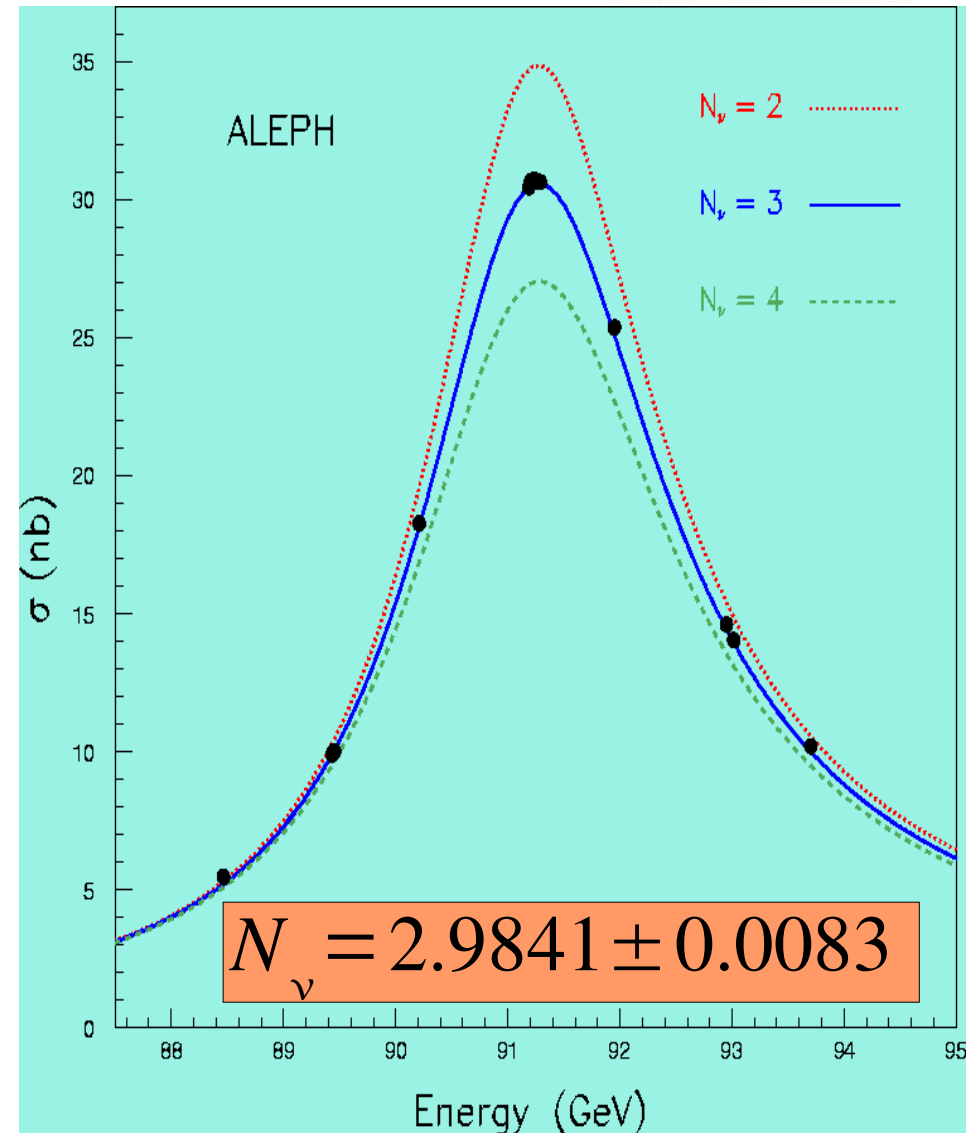

The Tau Neutrino

ν_τ was finally discovered by DONUT in 2000.

800 GeV protons on
Tungsten produce
 $D_s (=c\bar{s})$ mesons

$$D_s \rightarrow \tau + \nu_\tau$$

$$\nu_\tau + N \rightarrow \tau + X$$

$$\tau \rightarrow \mu + \nu_\tau + \bar{\nu}_\mu$$

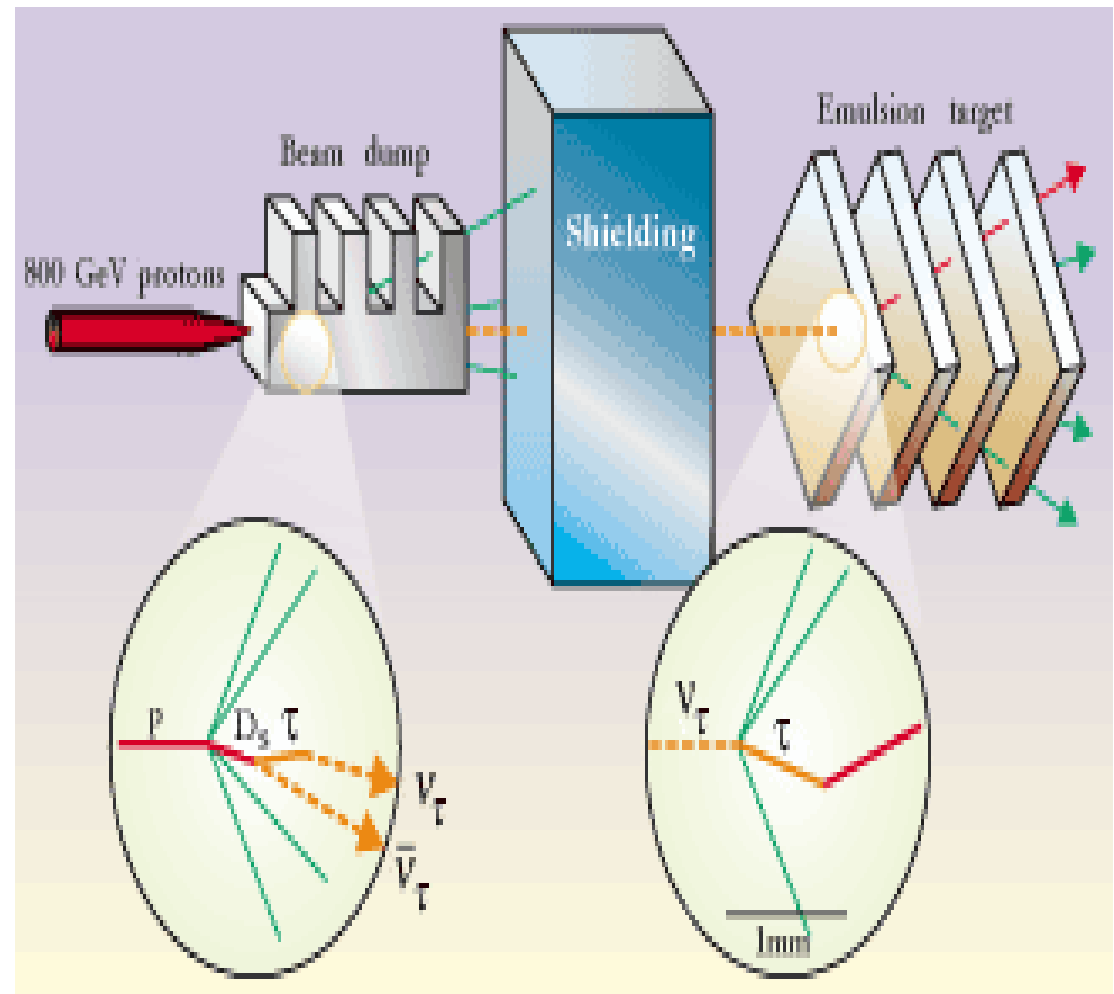

Discovery of the ν_τ

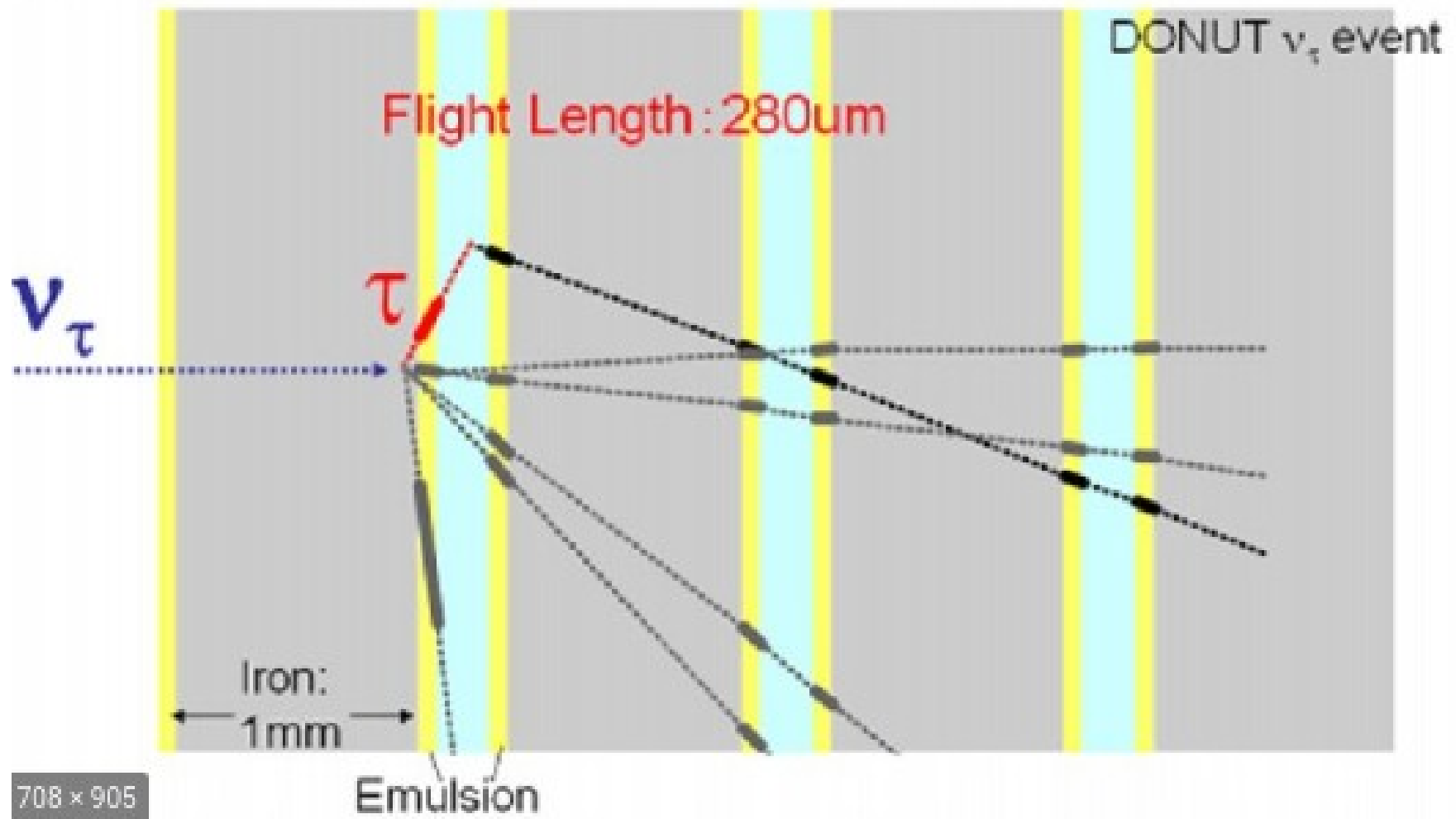

Neutrino Properties

- Electrically neutral and interact only via the weak interaction.
- spin $1/2$
- (anti)neutrinos are chirally left(right)-handed (but can be helically right(left)-handed if massive)
- Exist in (at least) 3 active flavours
- Are almost massless
- Are the most common fermions in the universe
- Is a neutrino its own anti-particle (Majorana particle)?
- Are there sterile neutrinos?
- What is the absolute neutrino mass?
- Is there CP violation in the neutrino sector?
- Does the neutrino have a magnetic moment?
- Are they stable?

Neutrino Properties

- Electrically neutral and interact only via the weak interaction.
- spin $1/2$
- (anti)neutrinos are chirally left(right)-handed (but can be helically right(left)-handed if massive)
- Exist in (at least) 3 active flavours
- Are almost massless
- Are the most common fermions in the universe
- Is a neutrino its own anti-particle (Majorana particle)?
- Are there sterile neutrinos?
- What is the absolute neutrino mass?
- Is there CP violation in the neutrino sector?
- Does the neutrino have a magnetic moment?
- Are they stable?

Making Neutrinos

Neutrino experiments are hard!

“..in an ordinary way I might say that I do not believe in neutrinos. Dare I say that experimental physicists will not have sufficient ingenuity to make neutrinos”

Sir Arthur Eddington

How to make a neutrino beam

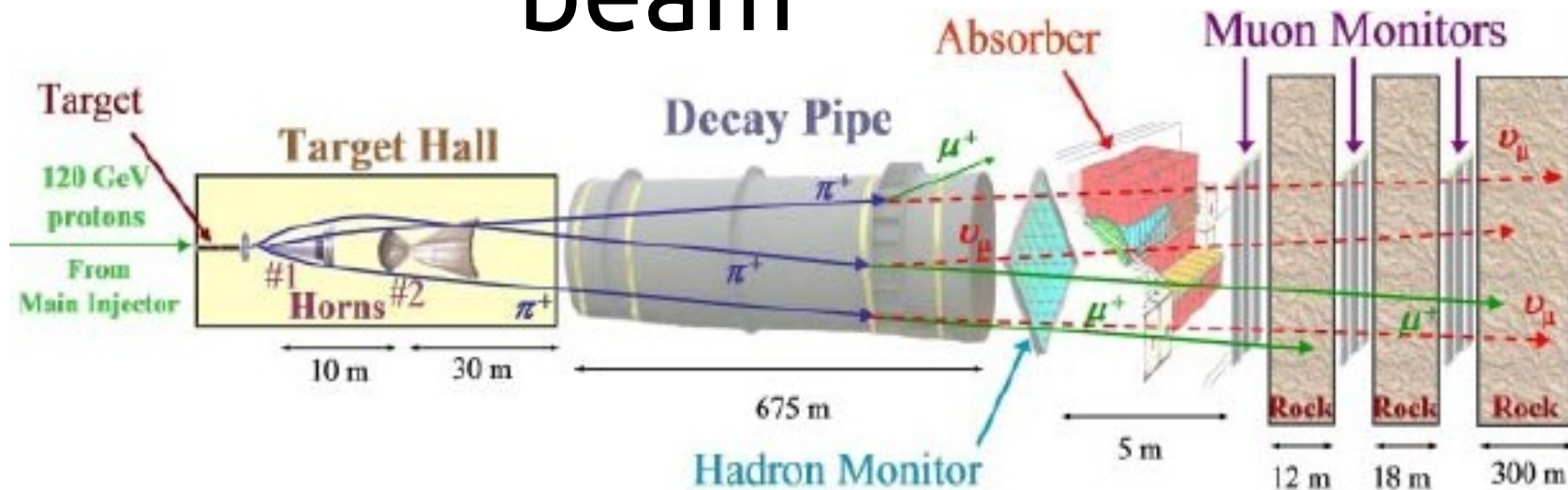

protons p/K $\mu, p, K, \nu_e, \nu_\mu$ ν_μ, ν_e

- Each part of the beamline must be designed with many tradeoffs in mind
- Major uncertainty in beam is the production of p/K in p-target interactions
- Total flux uncertainties $\sim 20\%$

Proton Beam

- Number of pions \propto total number of protons on target (POT) times proton energy
- The higher energy neutrino beam you want, the higher energy proton beam you need.

Source	p Energy (GeV)	p/year	Power (MW)	Neutrino Energy
FNAL Booster	8	5.0E+20	0.05	1
FNAL Main Injector	120	2.5E+20	0.25	3.0-17.0
CNGS (CERN)	400	4.5E+19	0.12	0.0-40.0
J-PARC (Japan)	30	1.1E+21	0.48	0.8
<i>LBNF (Fermilab)**</i>	<i>60 / 120</i>	<i>1.90E+21</i>	<i>1.2</i>	<i>0.5 – 10.0</i>
<i>J-PARC Upgrade**</i>	<i>30</i>	<i>1.60E+22</i>	<i>1.5</i>	<i>0.6</i>

**Design parameters – beams still under construction

Targetry

Have to balance competing needs

- The longer the target, the higher the probability that a proton will interact (☺)
- But more secondary particles will scatter (☹)
- The more protons interact the hotter the target will get (☹)
- The wider the target the cooler it is (☺) but more material to scatter secondaries (☹)

Low Z material (C, Be, Al) for heat properties

Usually around 50 cm to 1 m long

In small segments so that heating won't break the entire thing

Cooling systems needed (air, water, liquid helium)

Targetry

3.3E14 ppp w/ 5 μ s pulse

When this beam hits an iron block,

dose rate
> 1000Sv/h

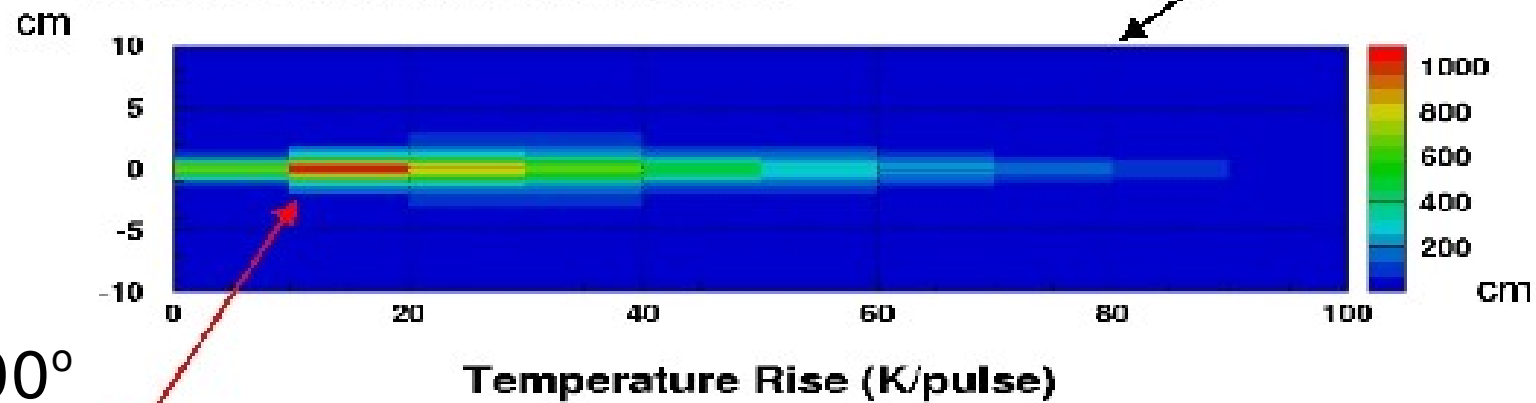

1100°



Target Infrastructure

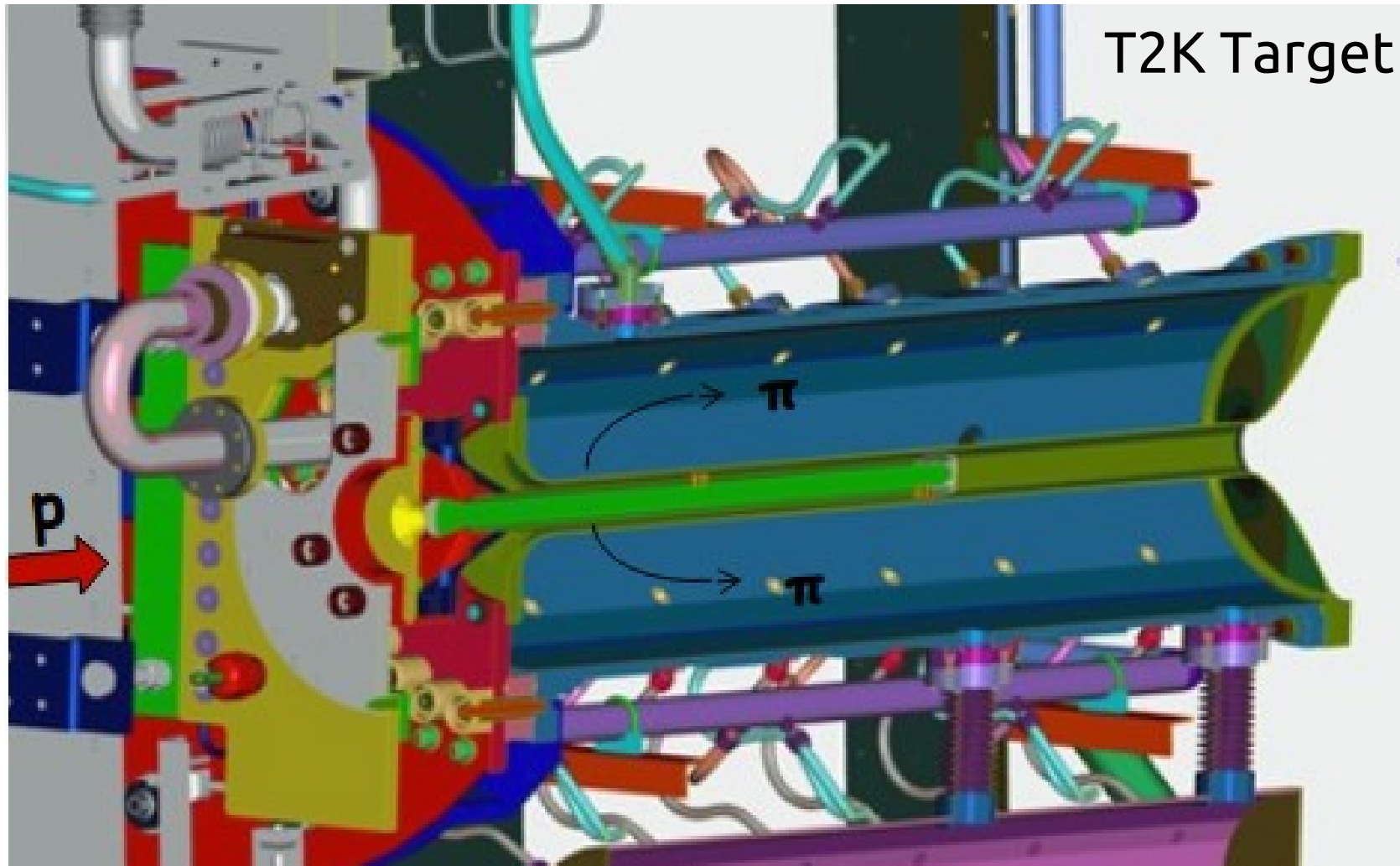

Basics of Horn Focussing

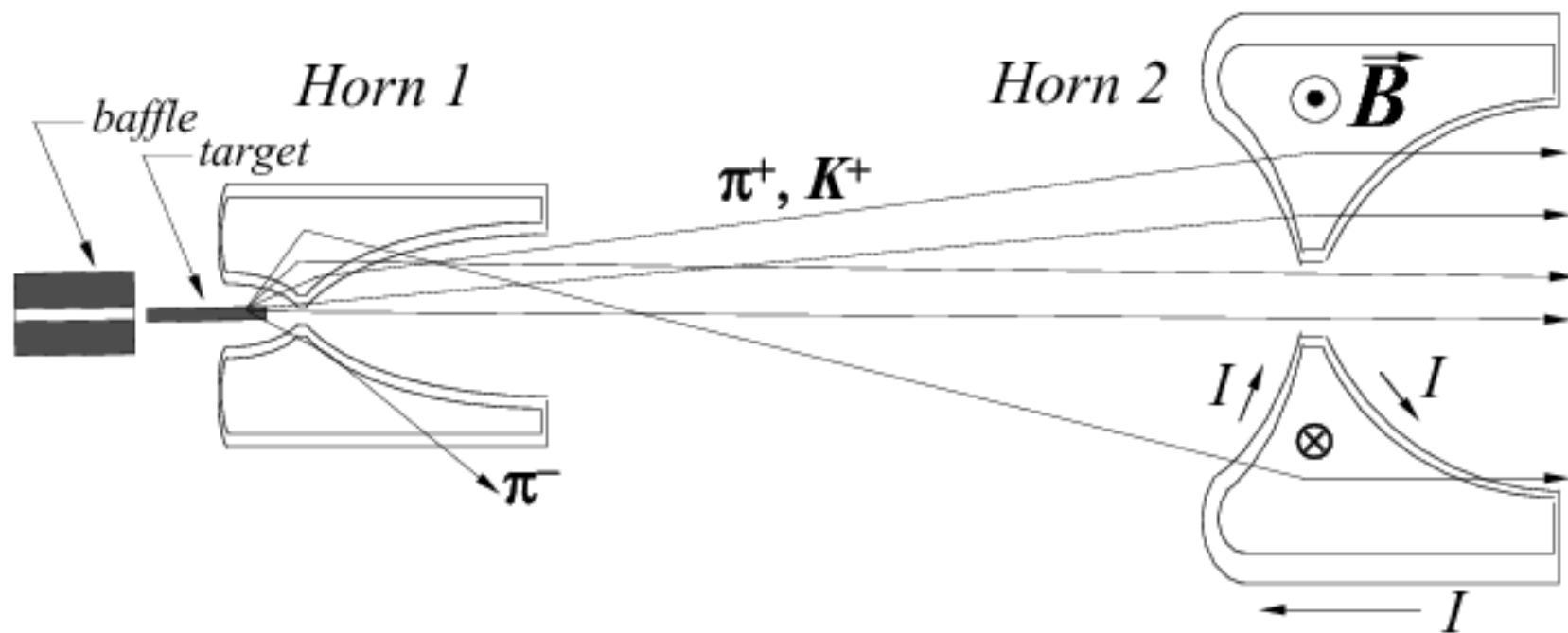

To give a 200 MeV transverse momentum kick to a pion requires a pulsed current of about 180 kA

Magnetic Horns



Decay Tunnel

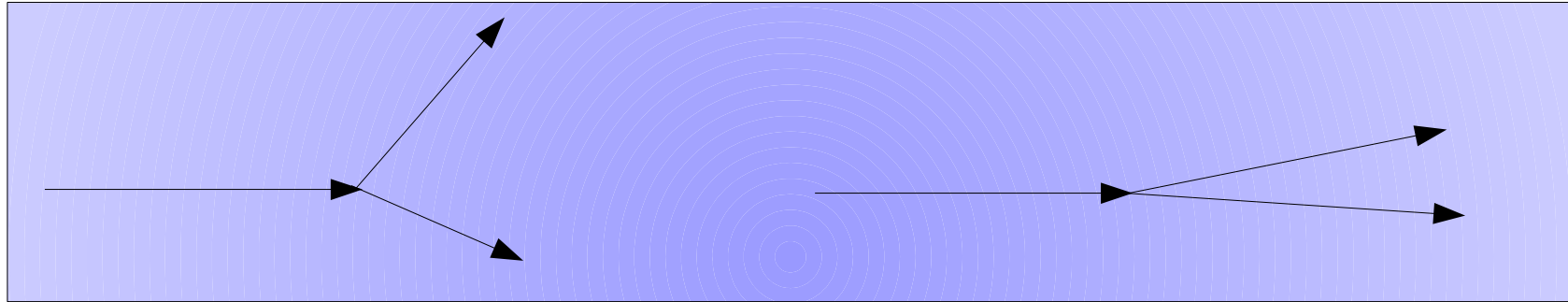

Low Energy decays

High Energy decays

$$P(\pi \rightarrow \nu \mu) = 1 - e^{-t/\gamma \tau} = 1 - e^{-Lm_{\pi}/E_{\pi} \tau}$$

Shorter tunnel, less pion decays

Longer tunnel, more pion decays, but muons decay to ν_e as well

Vacuum? Then more material is needed to hold it. Air?
Less material but interactions in decay pipe.

JPARC Facility

50 GeV Ring

ν line

3 GeV Ring

LINAC

400 MeV Linac (200 MeV)
1 MW 3 GeV RCS
0.5 MW 30 GeV MR
800 MeV Neutrinos

Wide band beams

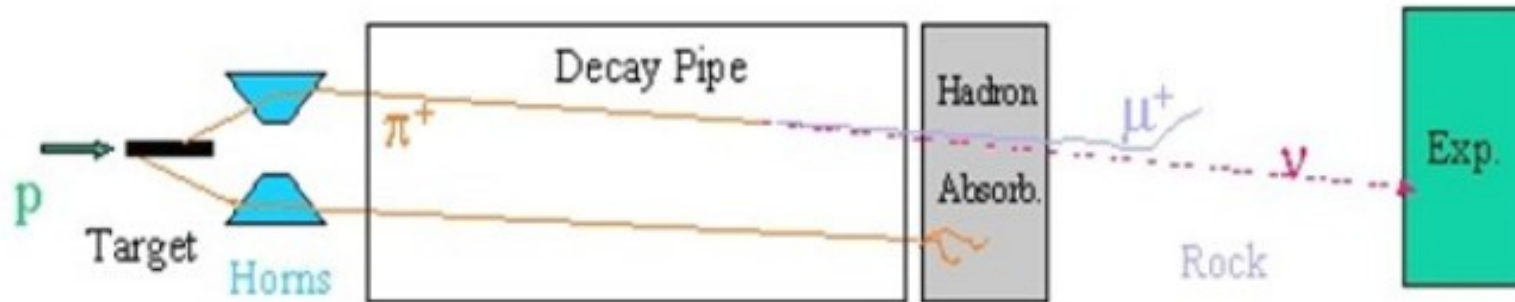

- Large flux of neutrinos.
- Wide range of energies.
- Complex mix of flavours.
- Hard to predict (and measure) neutrino flux.
- Spectrum is a function of radius and decay point

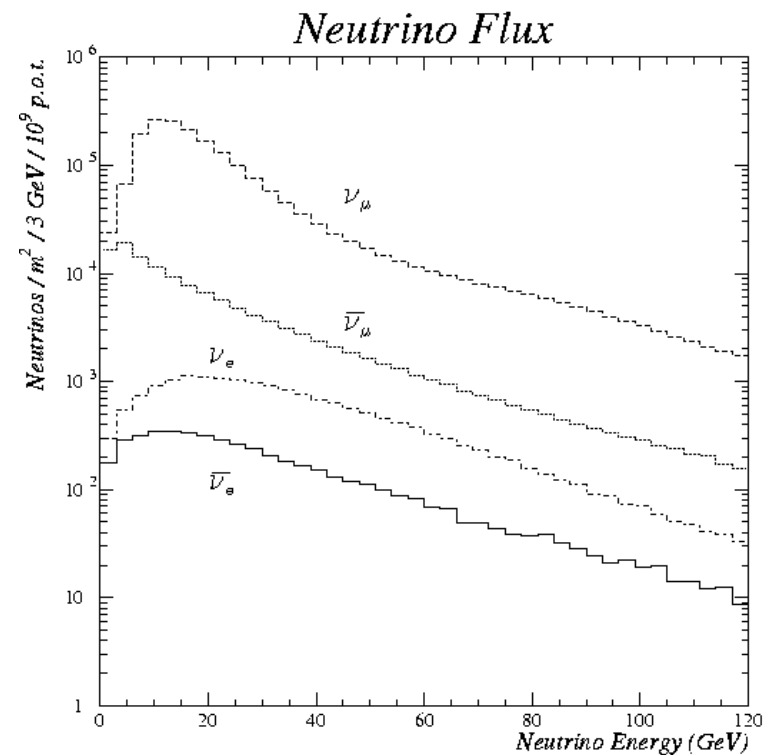

Narrow Band Beams

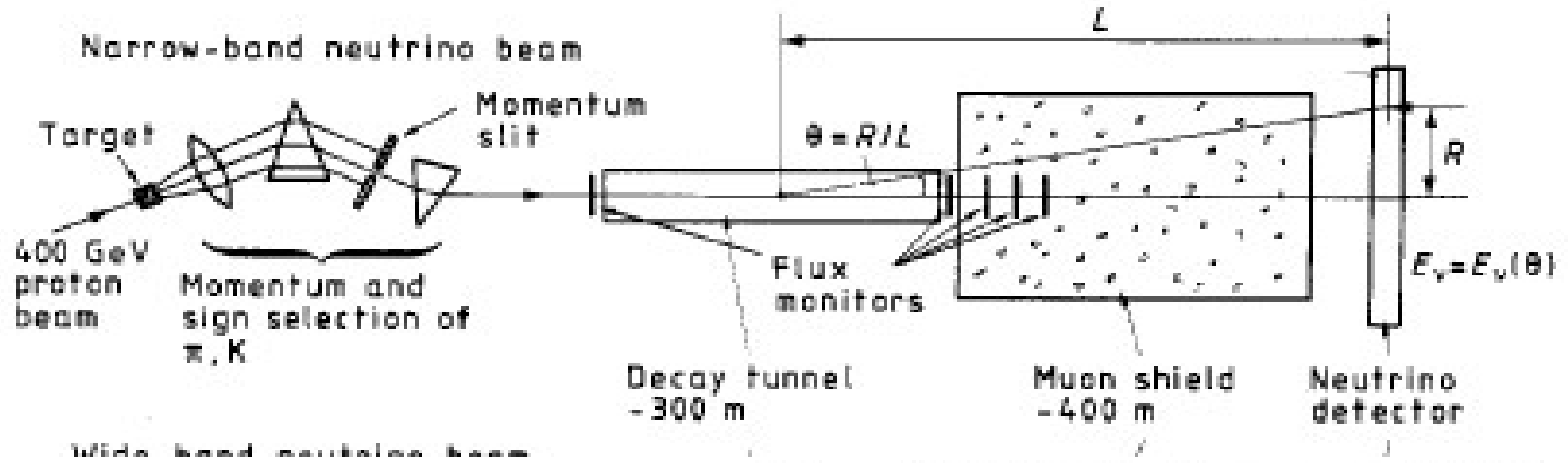

- Flat flux (easy to predict)
- Beam can be tuned to different energies
- flux is 100 times lower than WBB

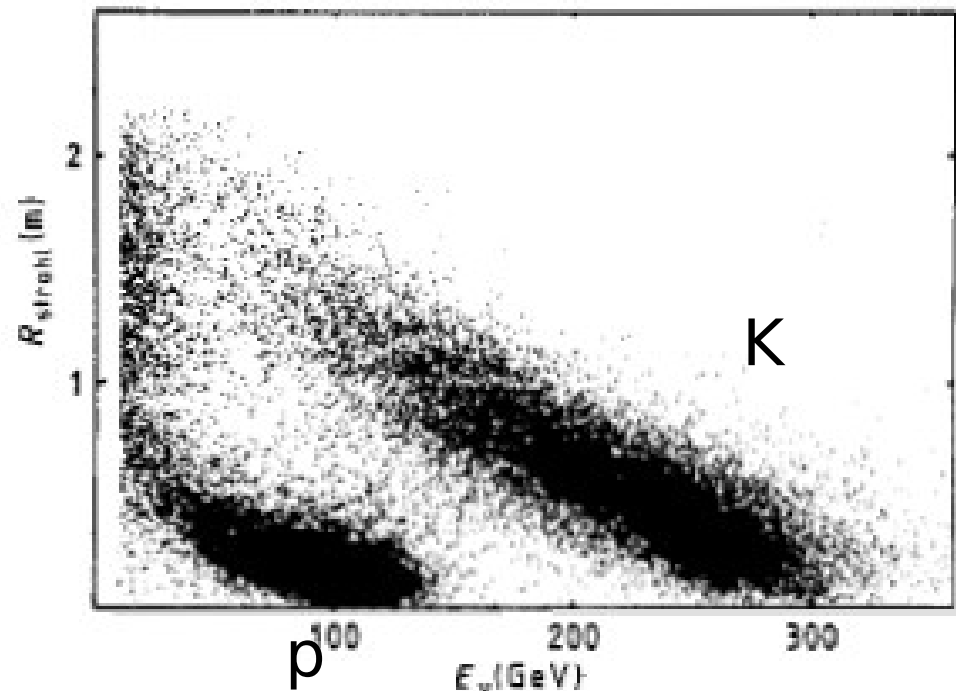

Off-axis beams

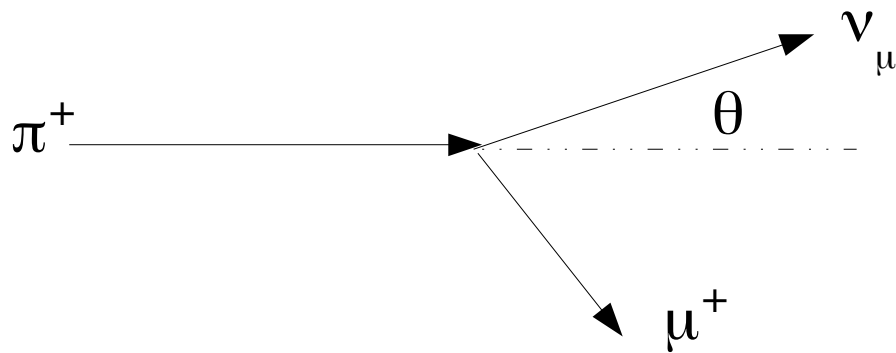

$$E_\nu = \frac{0.43 E_\pi}{1 + \gamma^2 \theta^2} \quad \gamma = \frac{E_\pi}{m_\pi}$$

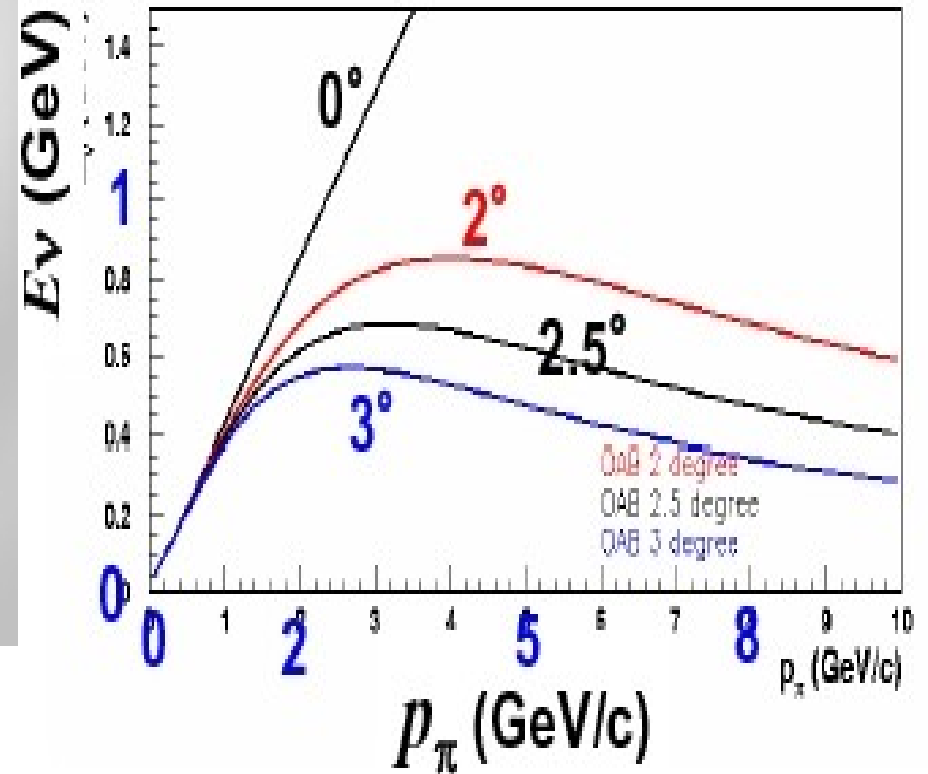
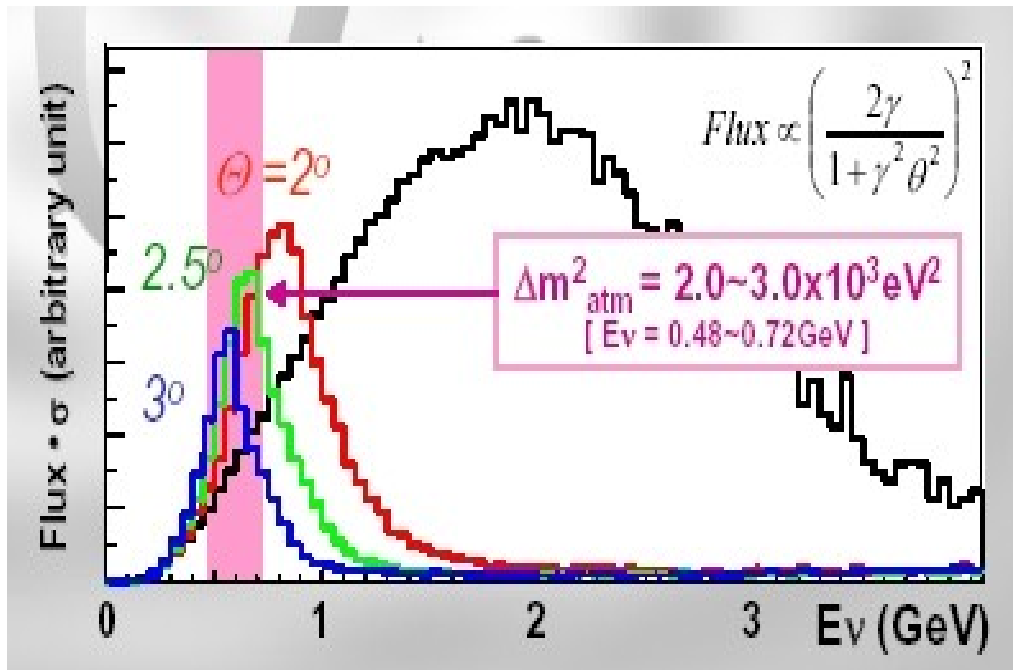

Neutrino Detection

So, you want to build
a neutrino detector?

So, you want to build a neutrino detector?

- How many events do you need to do the physics?
 - Determines detector mass
 - Determines the target type

So, you want to build a neutrino detector?

- How many events do you need to do the physics?
 - Determines detector mass
 - Determines the target type
- What kind of interaction? ν_e , ν_μ , CC, NC?

So, you want to build a neutrino detector?

- How many events do you need to do the physics?
 - Determines detector mass
 - Determines the target type
- What kind of interaction? ν_e , ν_μ , CC, NC?
- What do you want to measure?
 - Energy? Final state particles? This influences detector technology

So, you want to build a neutrino detector?

- How many events do you need to do the physics?
 - Determines detector mass
 - Determines the target type
- What kind of interaction? ν_e , ν_μ , CC, NC?
- What do you want to measure?
 - Energy? Final state particles? This influences detector technology
- What sort of backgrounds do have to deal with?
 - More influence on technology - usually conflicting with signal requirements.

So, you want to build a neutrino detector?

- How many events do you need to do the physics?
 - Determines detector mass
 - Determines the target type
- What kind of interaction? ν_e , ν_μ , CC, NC?
- What do you want to measure?
 - Energy? Final state particles? This influences detector technology
- What sort of backgrounds do have to deal with?
 - More influence on technology – usually conflicting with signal requirements.
- How much  do you have?

Usual collider detector

The ATLAS Detector

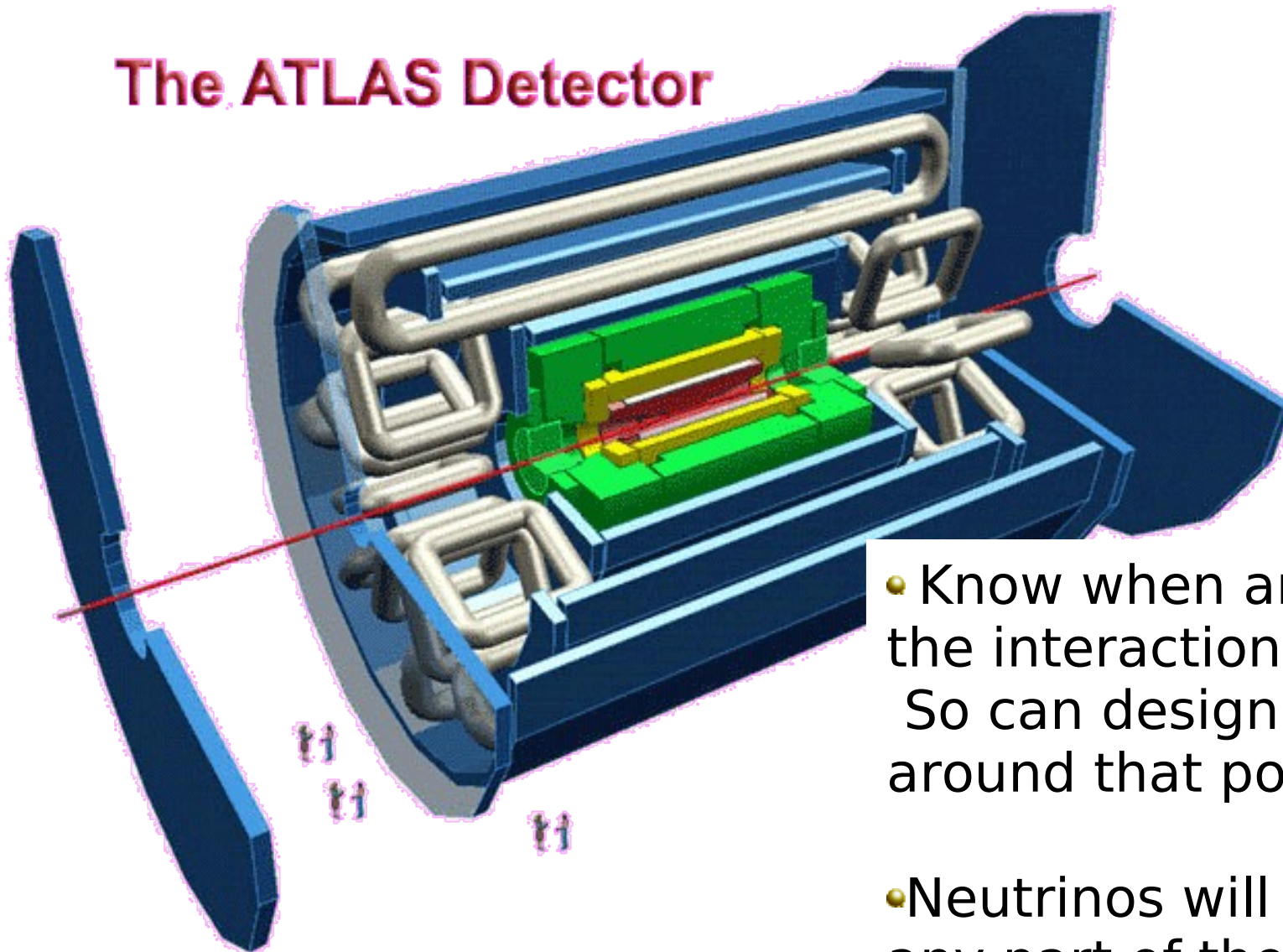

- Know when and where the interaction will occur. So can design a detector around that point
- Neutrinos will interact in any part of the detector

Neutrino Detectors

- No neutrino colliders – detector IS the target
- Low cross section implies large mass and hence **cheap** material
- Neutrinos interact everywhere – vertex can be anywhere
- Neutrinos interact in matter - so final state is subject to nuclear potentials
- Need to identify charged lepton to separate NC and CC and neutrino flavour
- Measurement of energy and scattering angle of charged lepton
- Measurement of total hadronic energy
- Identification of single hadrons for hadronic studies

No experiment can satisfy all these requirements
Most experiments fall into one of a few types

Types of detectors

- Radiochemical experiments
- Water (H_2O or D_2O) experiments
- Scintillator detectors
- Tracking calorimeters

Radiochemical Experiments

This technique uses the production of radioactive isotopes.

Davis-Pontecorvo experiment was the first attempt to use this to look at solar neutrinos



The isotopes Ar or Ge are radioactive. In this type of experiment the isotopes are chemically extracted and counted using their decay

Disadvantage is that there is no information on interaction time or neutrino direction, and only really generates “large” count rates for low energy neutrinos (in the MeV range)

The Davis Experiment

The very first solar neutrino experiment in the Homestake mine in South Dakota

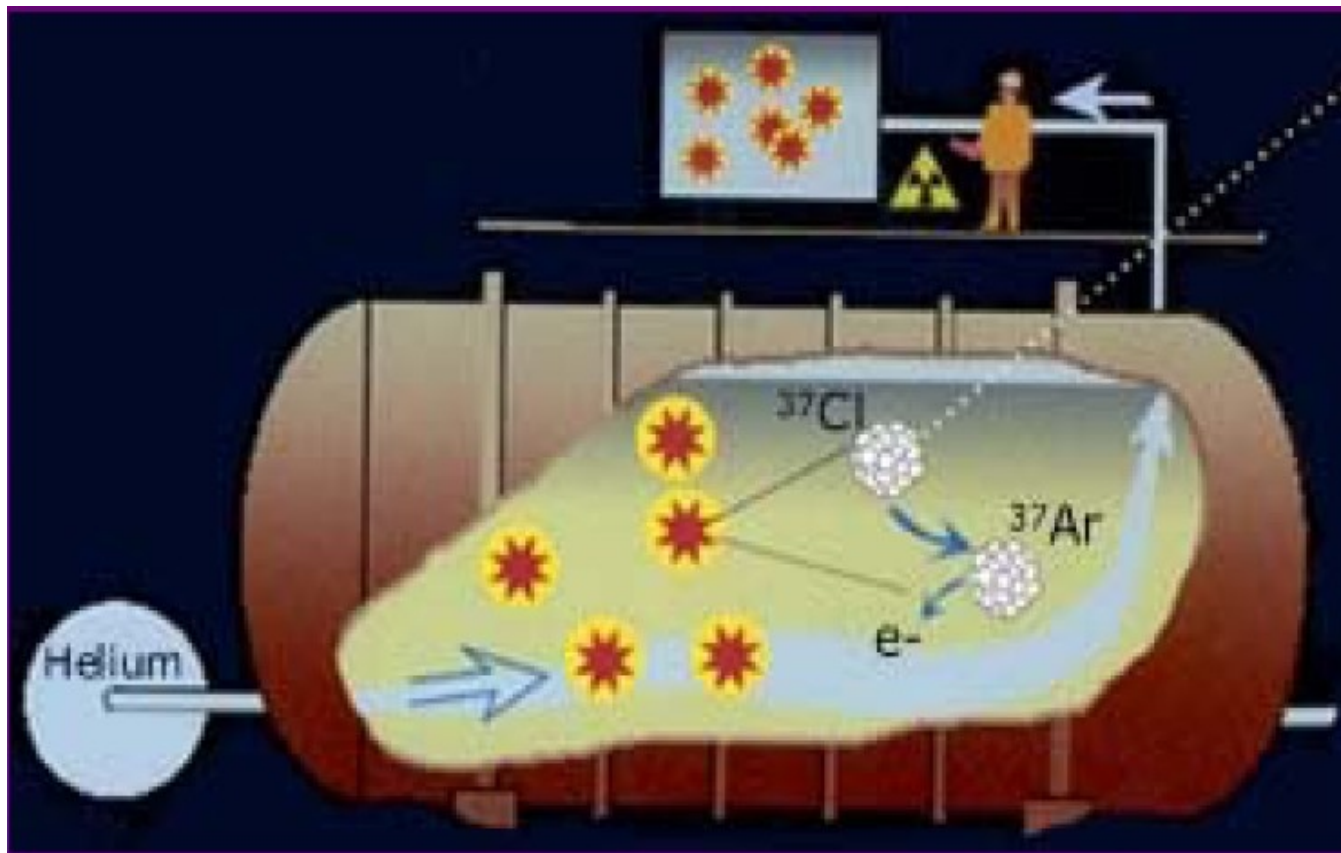

615 tonnes of Ccl_4
Ran from 1968
to 1994

Individual argon
atoms are captured
and counted.

1 atom per 2 days.

Threshold : 814 keV

Water Experiments

Water is a very cheap target material – these experiments detect charged particles using Cerenkov radiation.

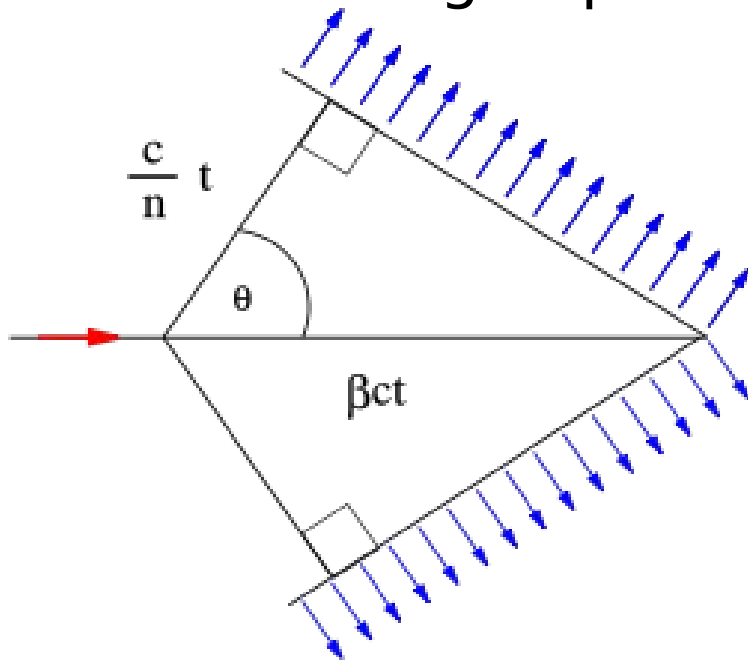

If a charged particle moves through a material with $b > 1/n$ it produces an EM shockwave at a particular angle.

$$\cos \theta = 1 / \beta n$$

The shockwave can be detected and used to measure the particle direction and vertex.

Particles below threshold and neutral particles are not detected

*See Antonis' lecture on Friday for more uses of the Cerenkov technique

Principle of operation

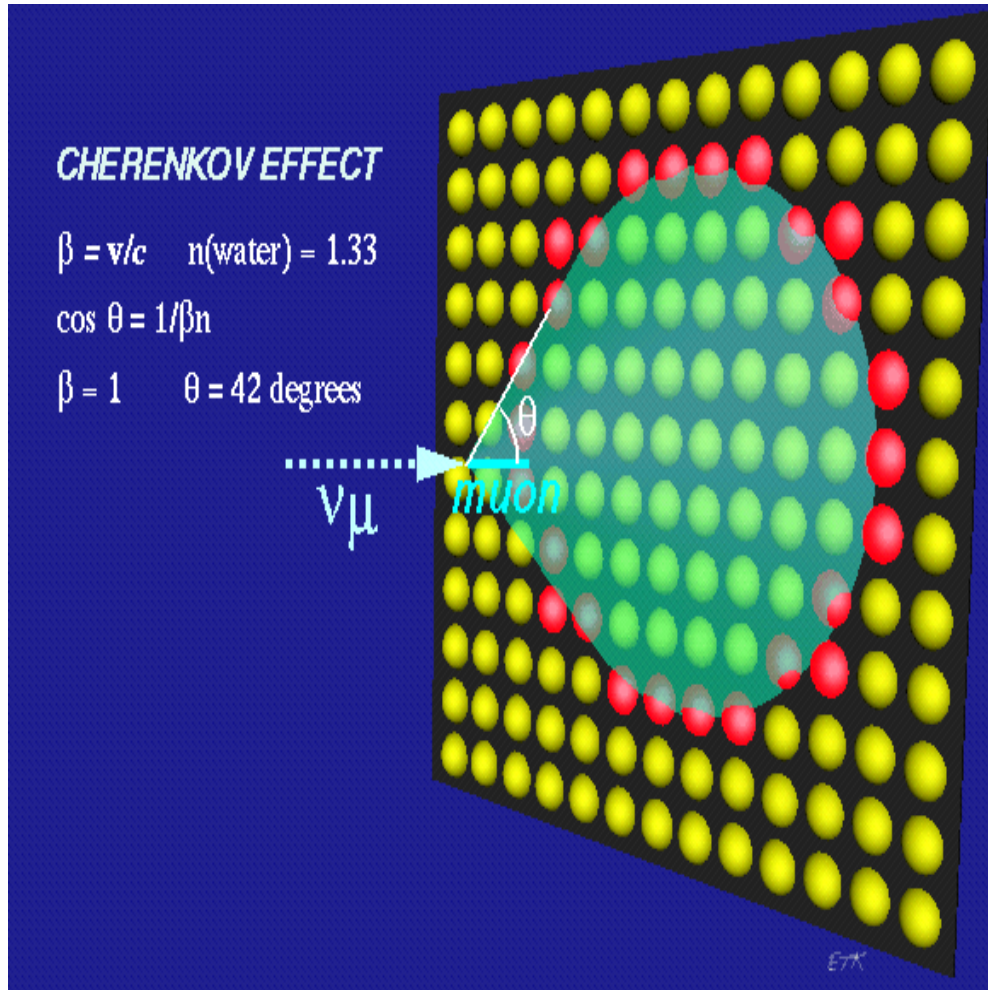

- Cerenkov light detected as a ring or circle by PMTs
- Vertex from timing
- Direction from cone
- Energy from summed light
- No neutrals or charged particles under Cerenkov threshold
- Low multiplicity events

Super-Kamiokande

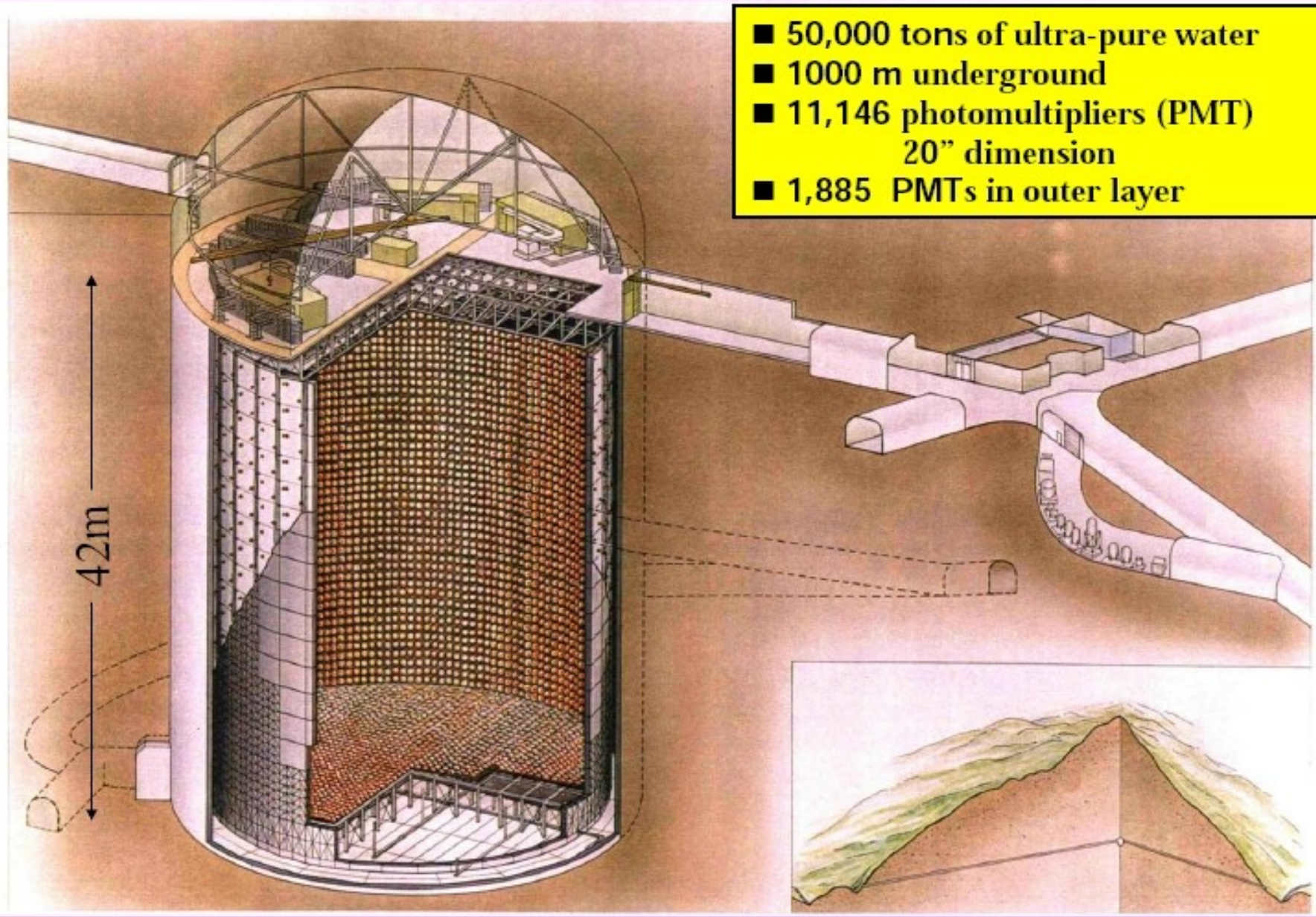

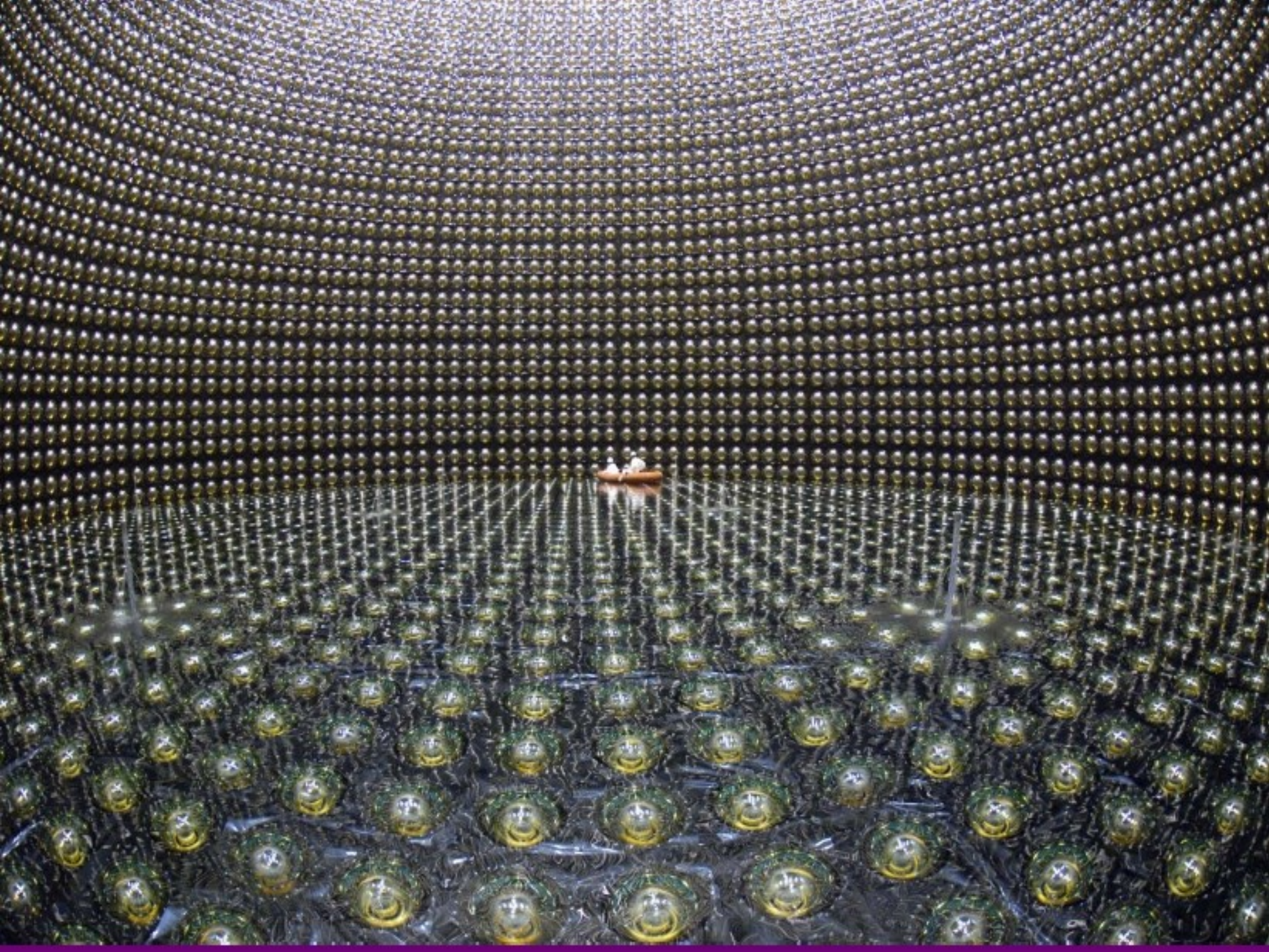

Directionality

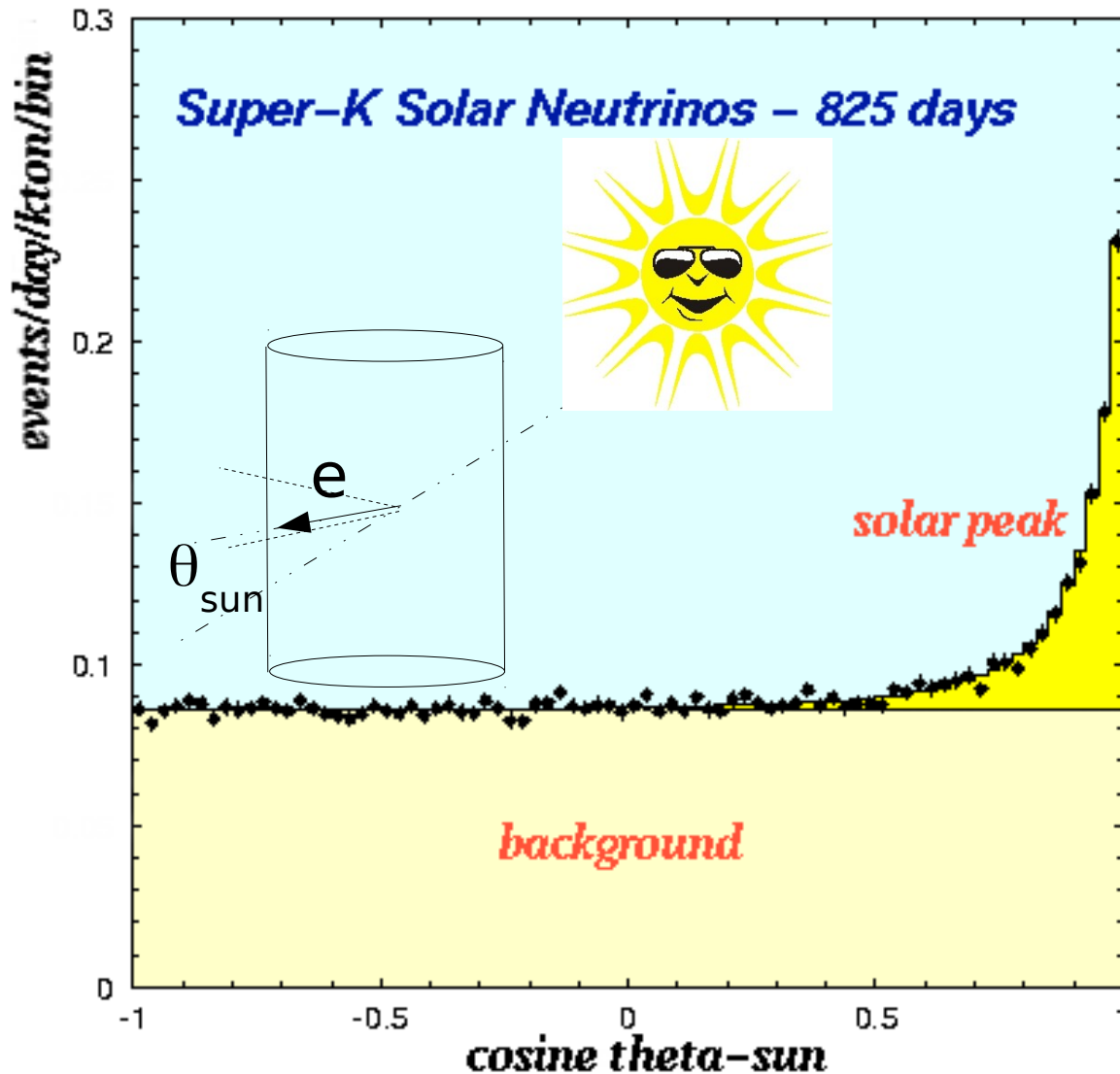

For simple events , the direction of the ring can be used to point back to the neutrino source

Proof that these neutrinos were coming from the sun

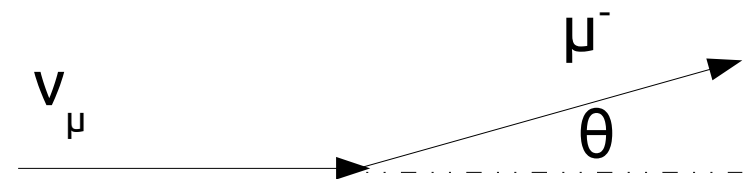

e-like

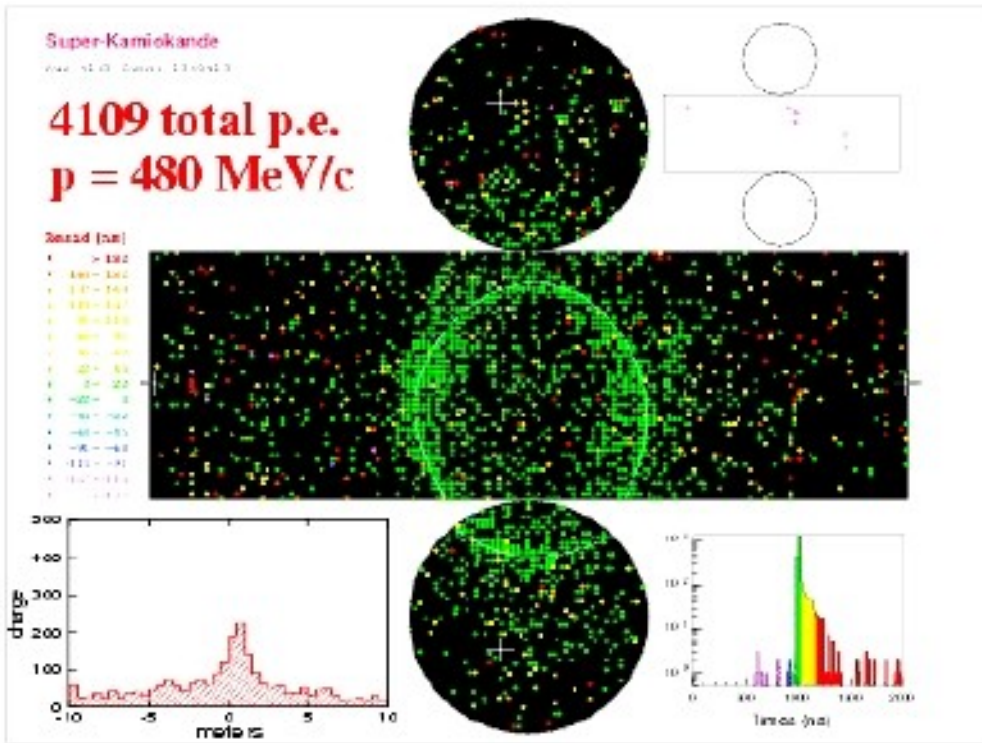

μ -like

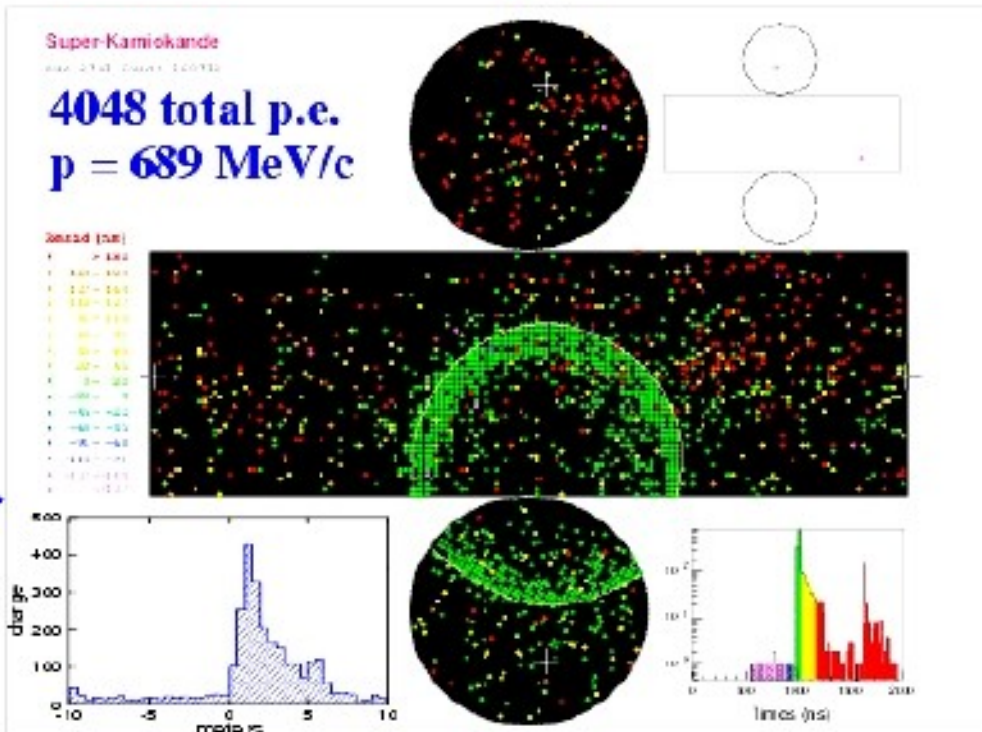

Electron-like : has a fuzzy ring

Colours = time of hit
Event energy = sum of PMT signals

Muon-like : has a sharp edged ring and particle stopped in detector.

Problems

- Any particle below threshold is not seen
- Neutral particles are not observed
- Multi-ring events are extremely hard to reconstruct

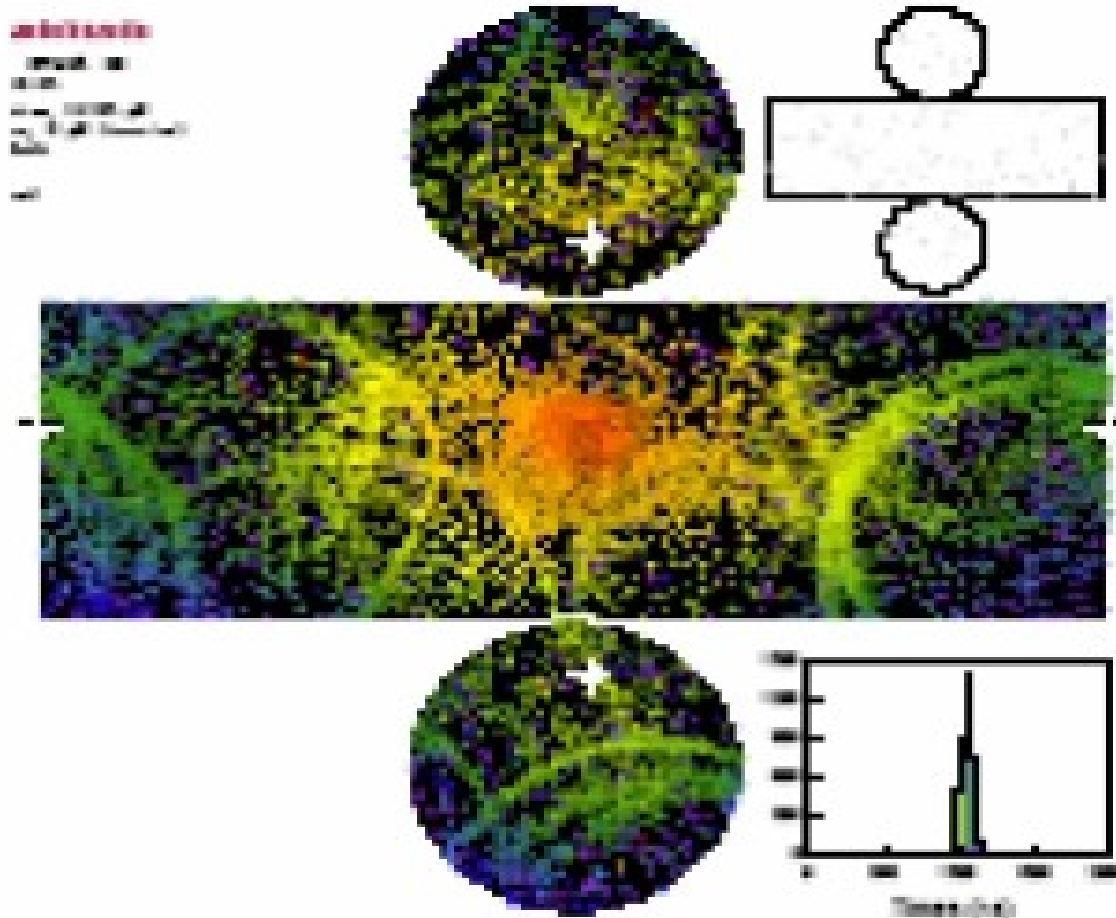

Scintillator Detectors

Light emission following ionisation

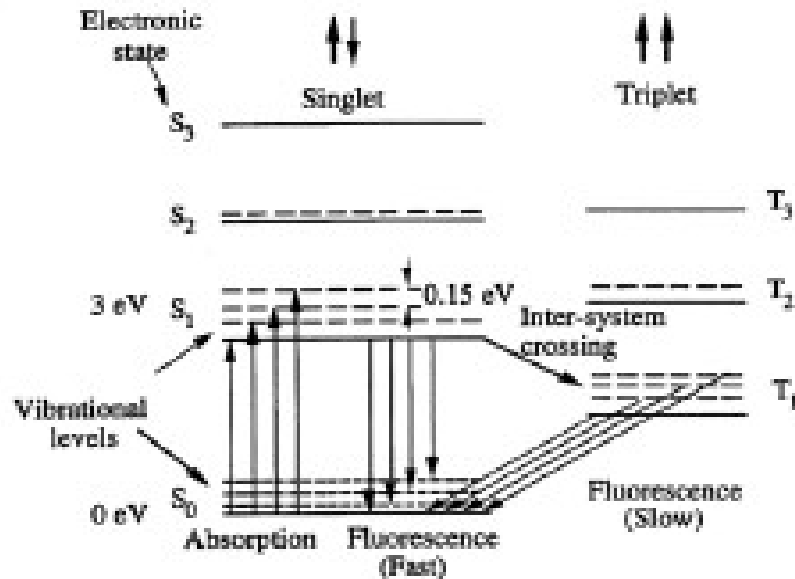

Organic liquids and plastics

Inorganic crystals

Nobel liquids

- In a good scintillator, much **more** light is emitted by scintillation than by the Cerenkov process.
- **Scintillation light is isotropic and there is no threshold.**
- But no information on directionality, the emission wavelength depends on the scintillator material, and the scintillator is usually highly toxic.

KamLAND

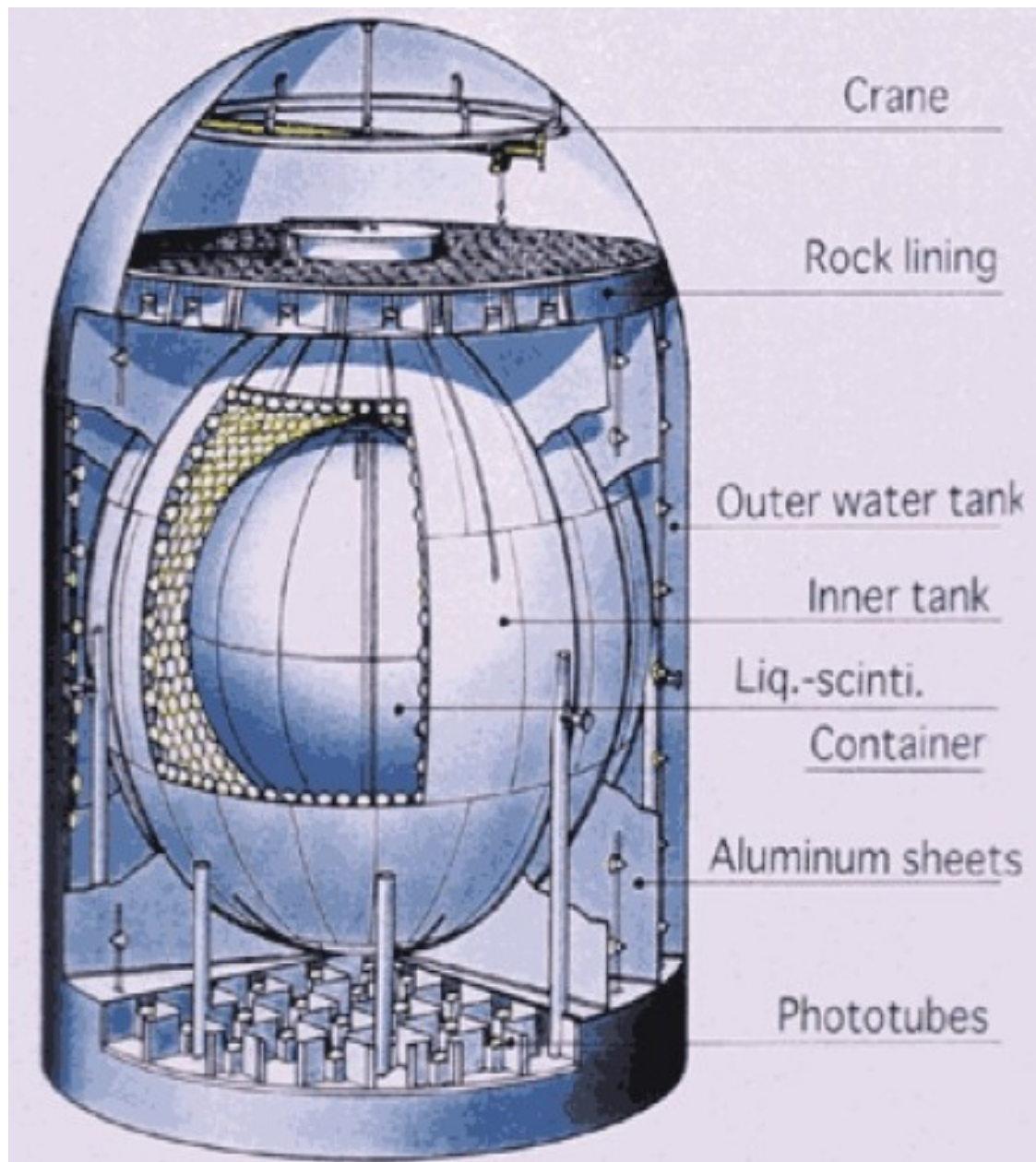

- External container filled with 3.2 kton H_2O
- Inner sphere filled with 2 kton of mineral oil
- Inside transparent balloon filled with 1 kton of liquid scintillator
- Located 1km deep in the Kamioka mine, just up the street from Super-Kamiokande
- Very pure – background is a major problem.

Event Displays

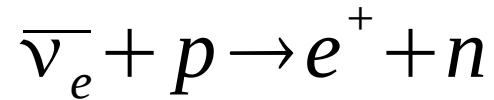

200 ms later

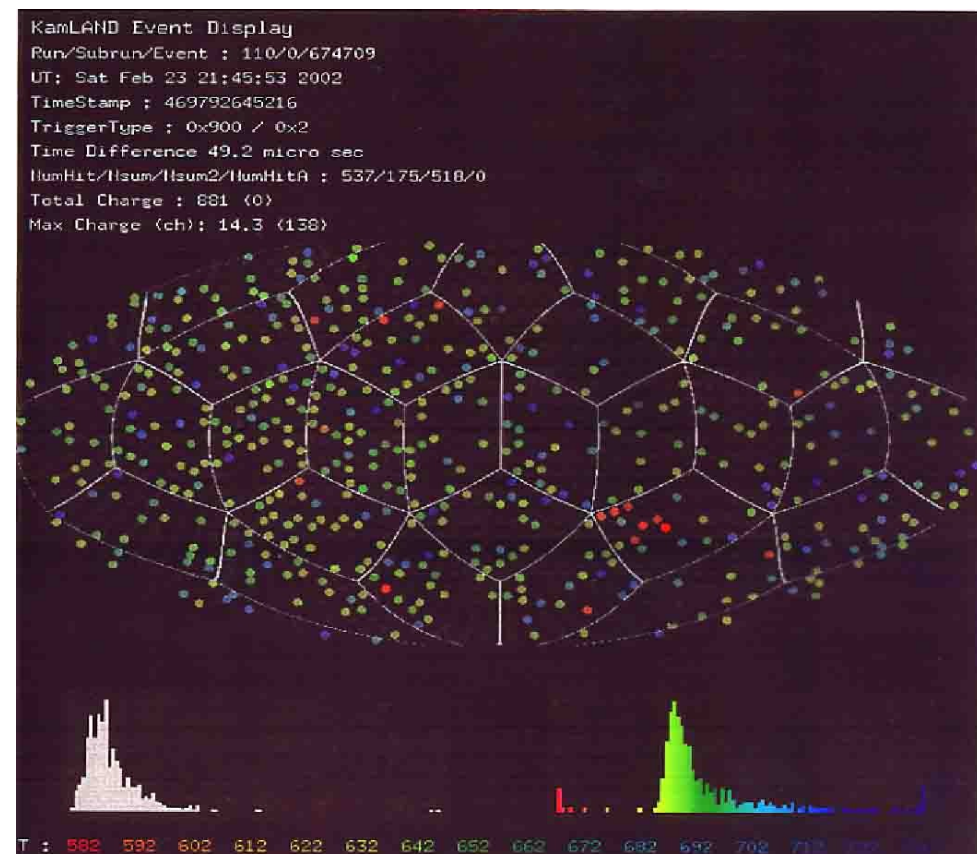
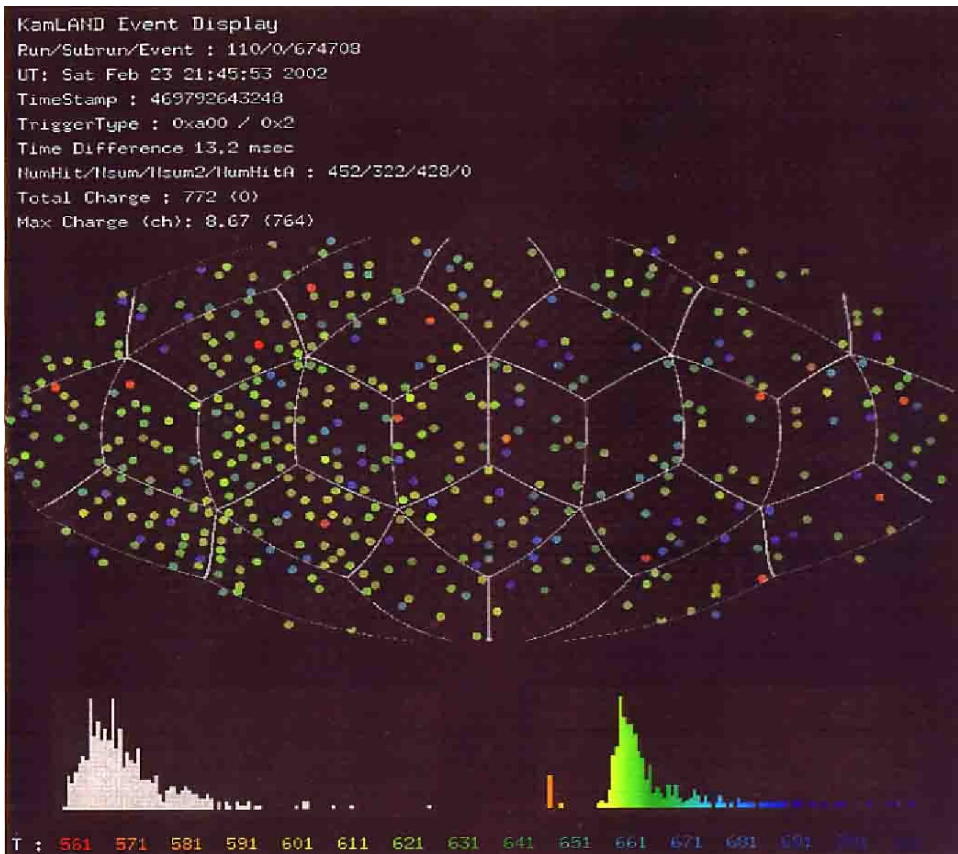
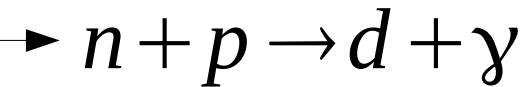

Tracking Calorimeters

Layers of target: eg. steel, marble, glass

Layers of ionization detector:
spark chambers
proportional counters
scintillator strips
drift tubes
resistive plate chambers (RPCs)

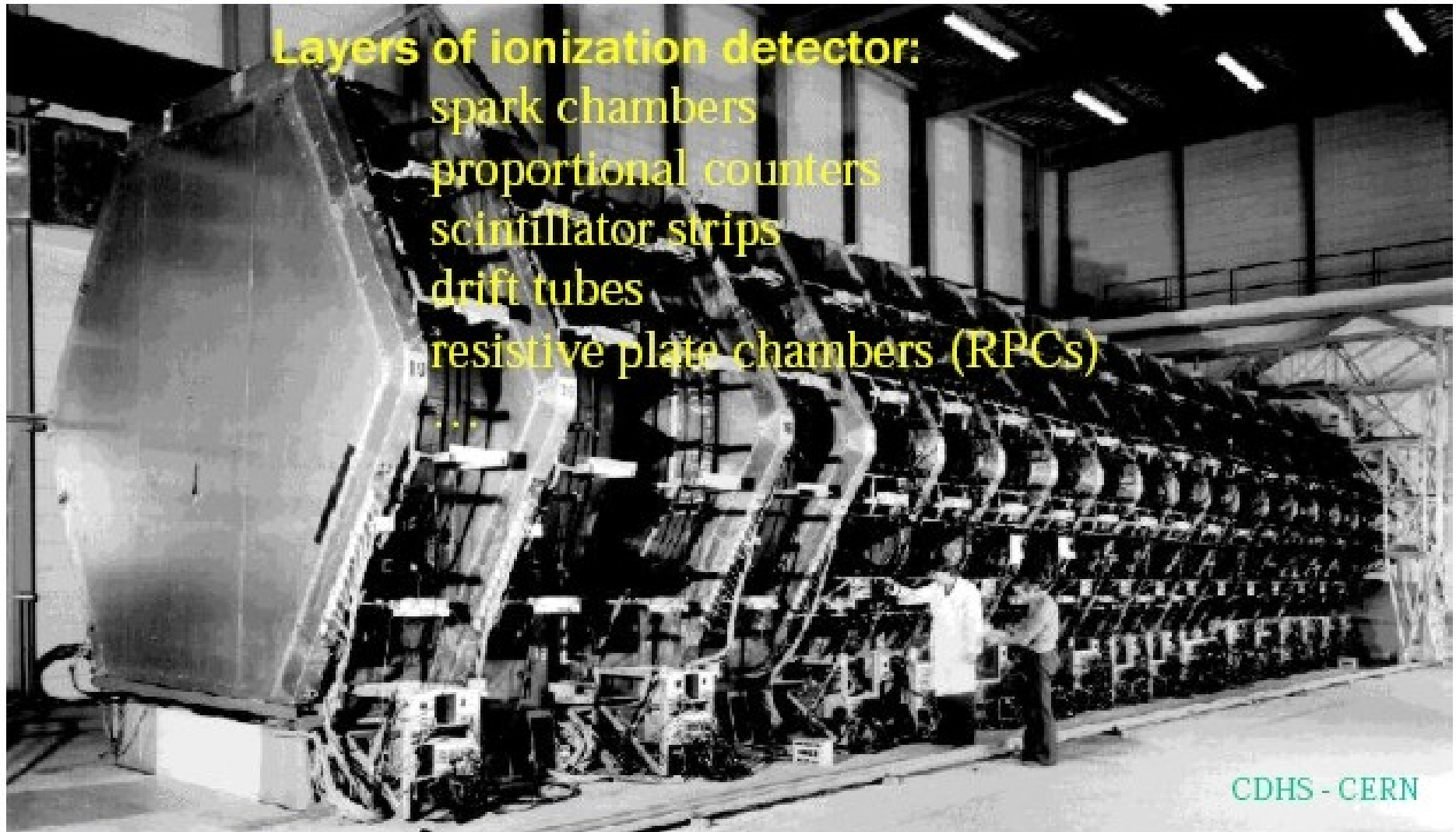

Tracking Chambers

WARWICK

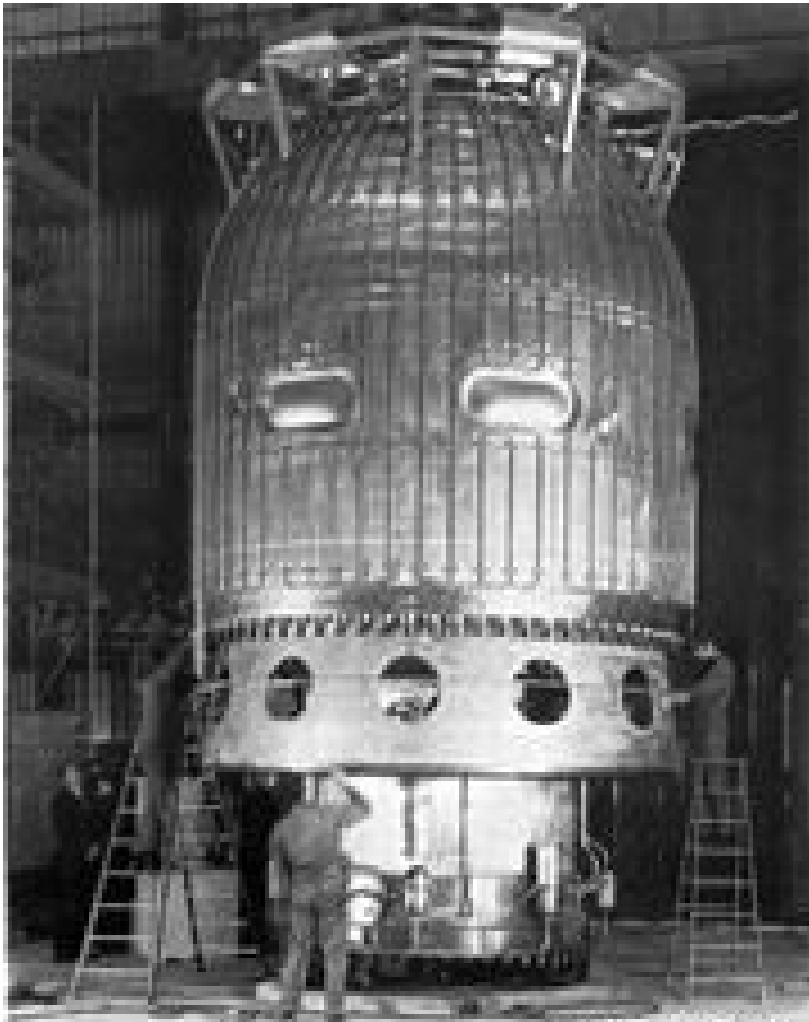
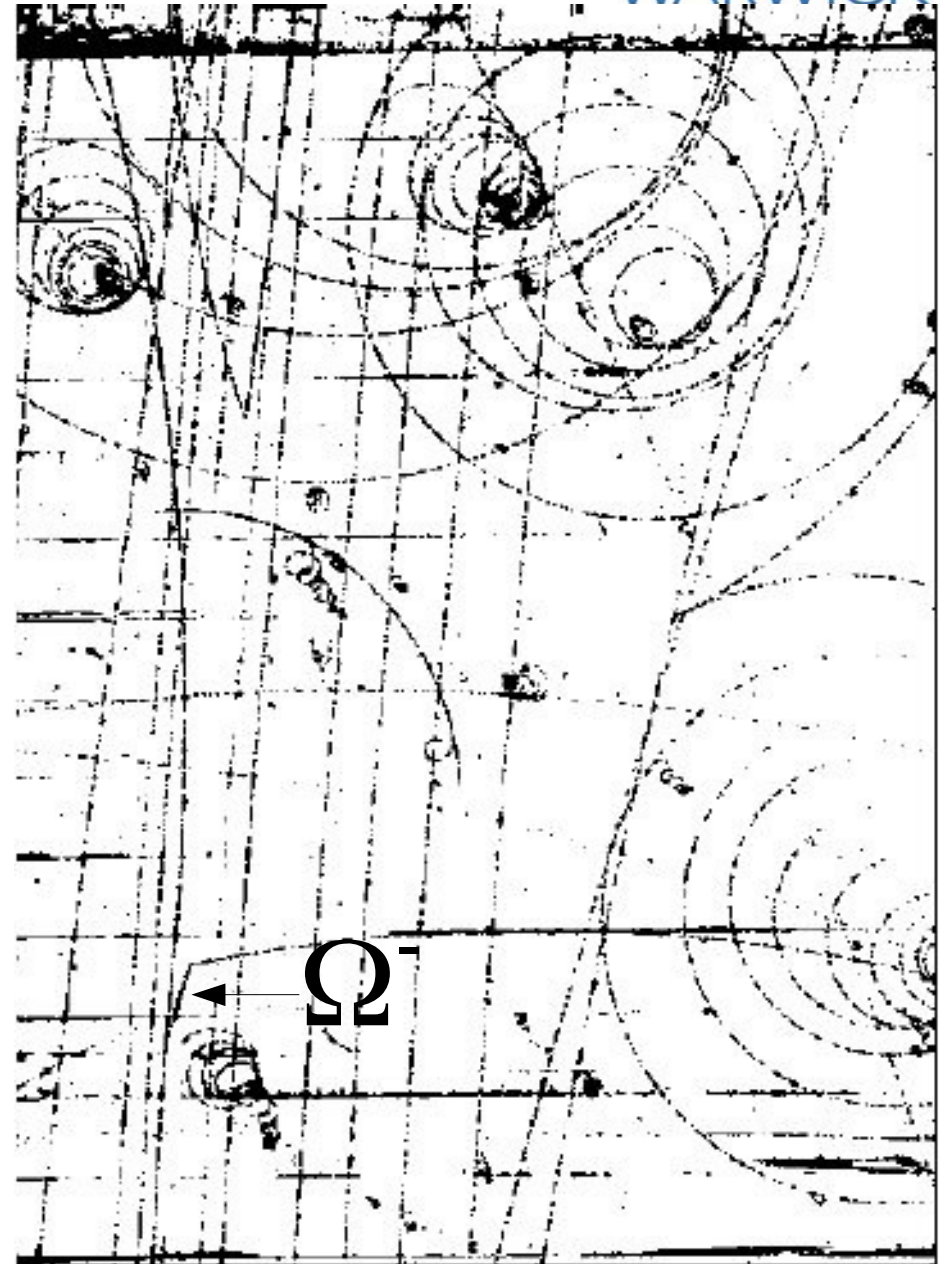

Photo: CERN

BEBC Chamber





The LBL Frankenstein

Scan 24,000 events per year and required 5 people to keep operating

S-UTS in Japan (Nagoya)

OPERA Experiment



Dedicated hardware
Hard coded algorithms

High speed CCD Camera (3 kHz)
Synchronization of objective lens and stage
1h35m/brick for 100 predictions

NUTEV

Iron Sampling calorimeter : CDHS,CHARM,CCFR,NUTEV,MINOS

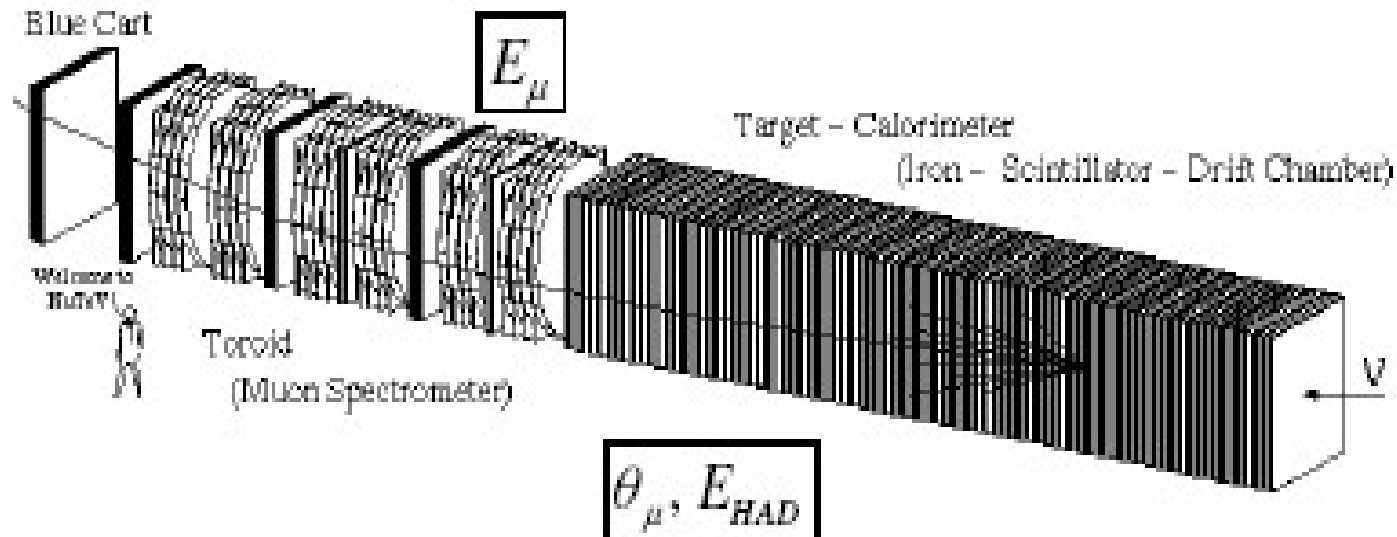

- Typically used for high energy ($>$ a few GeV) beams
- Iron plates (target) interspersed by scintillator planes
- Muon tracked and radius of curvature measured in toroid
- Hadronic energy summed from active detector but single track resolution is not achievable

NuTeV Event Display

Run: 5467 Event: 773 Igate: 1 Date: Fri Sep 6 23:45:58 1996

Triggers: **1** **2** **3** **4** 5 6 7 **8** 9 10 11 12 13

EMU1:	31.70 GeV
EHDNC:	46.99 GeV
PLACE:	60
CEXIT:	1
SHEND:	50

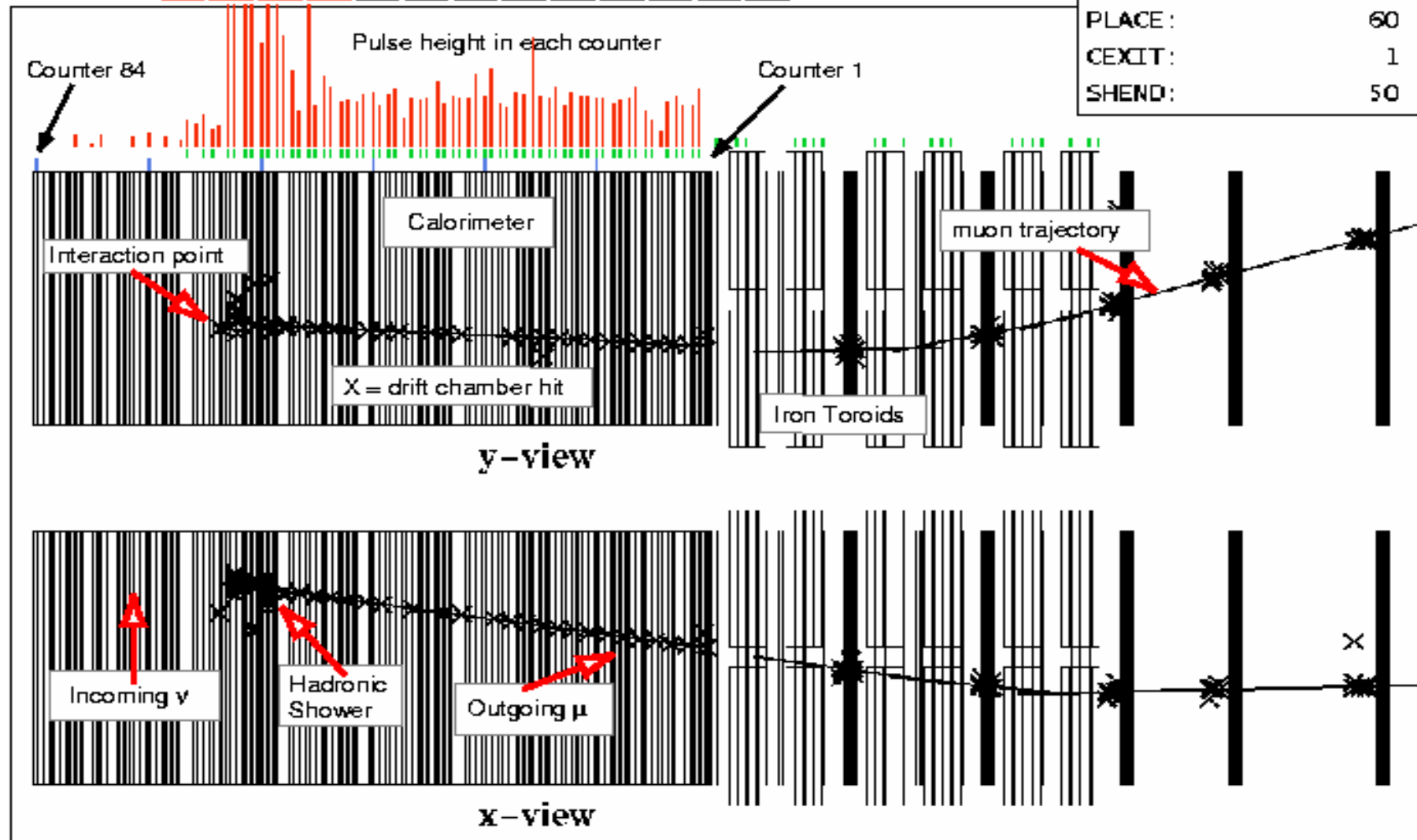

T2K ND280

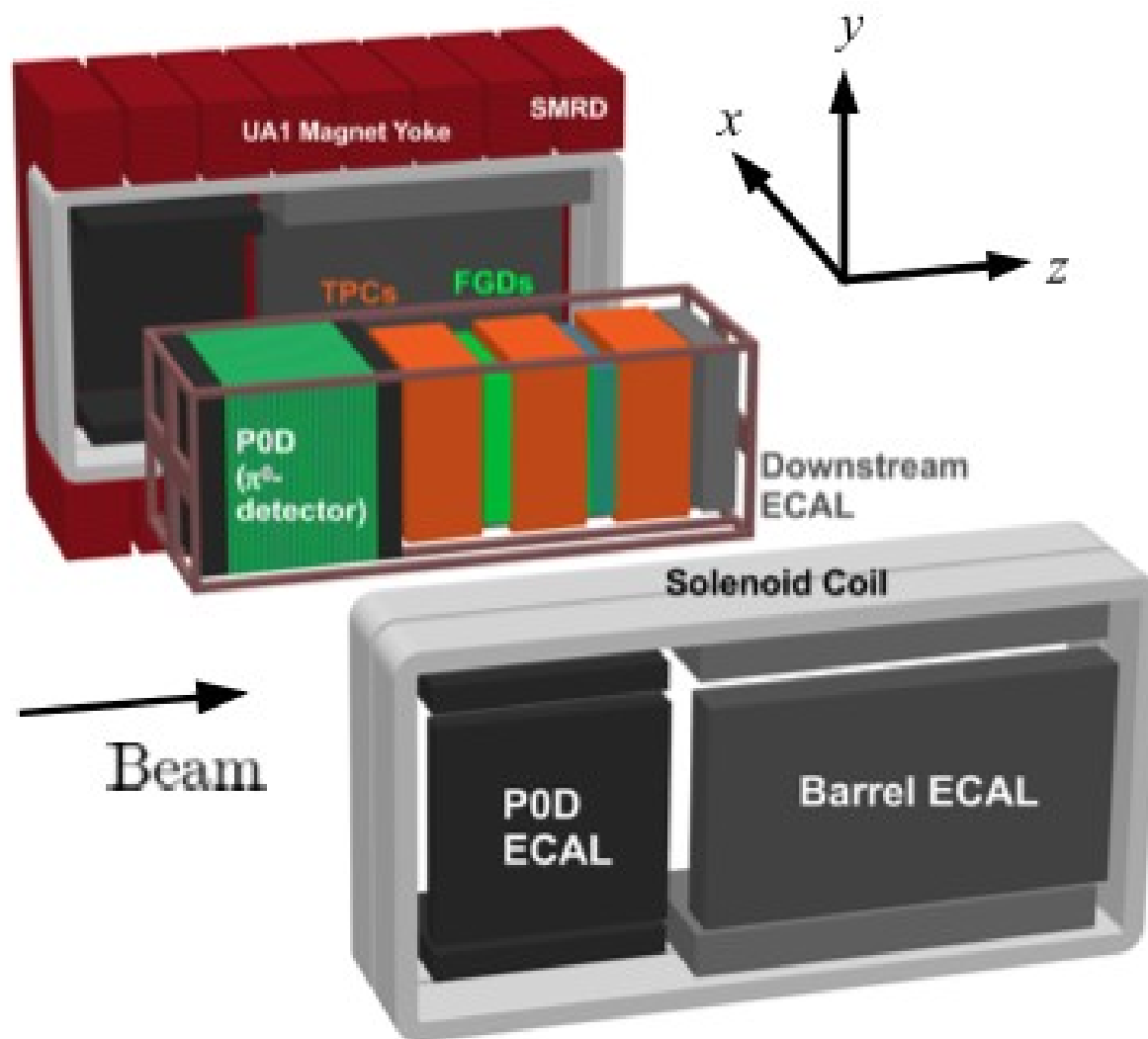

T2K

Event number : 53975 | Partition : 63 | Run number : 5012 | Spill : 52286 | SubRun number : 10 | Time : Mon 2010-06-14 02:41:00 JST | Trigger: Beam Spill

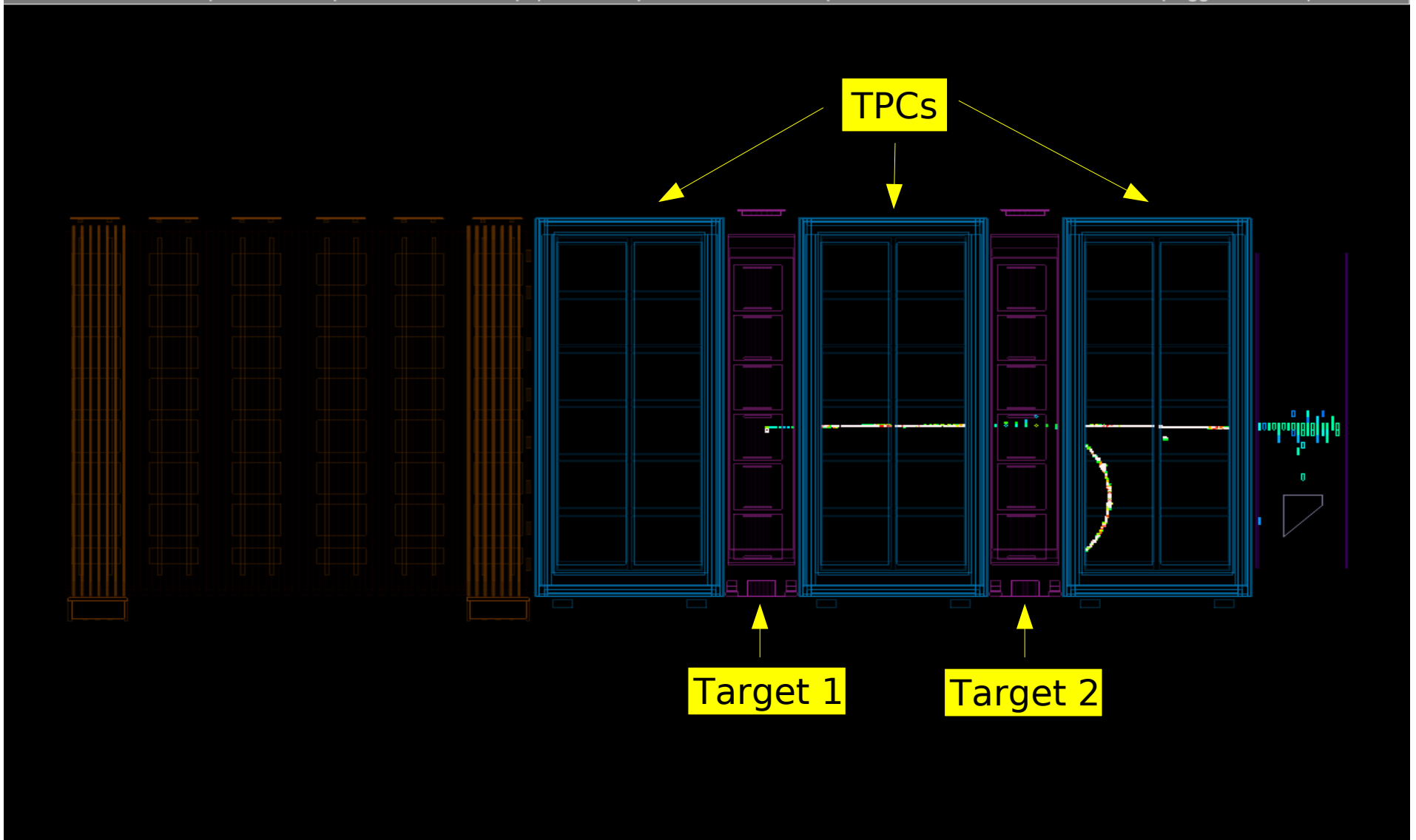

Liquid Argon TPCs

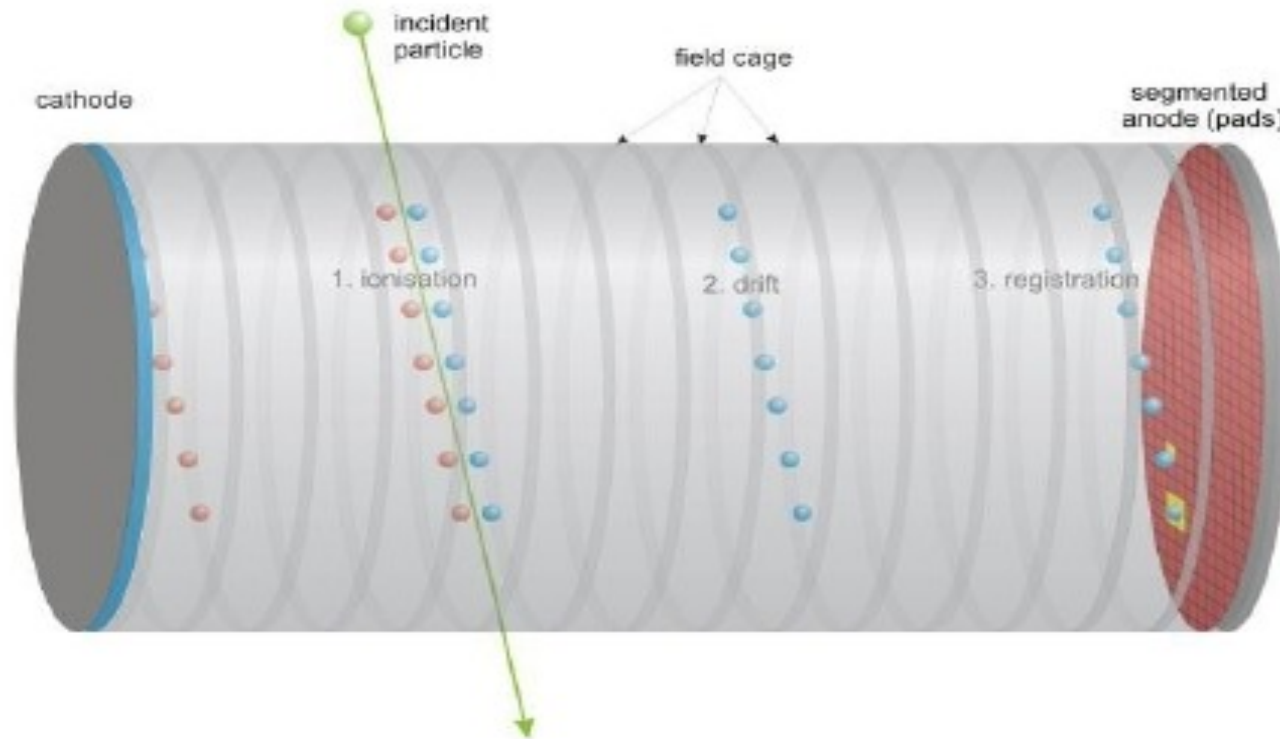

3D tracking with excellent resolution
Calorimetry from energy deposition in filler material
Filler can be gas or liquid.
Neutrino Physics looking at liquid argon TPCs

LAr event

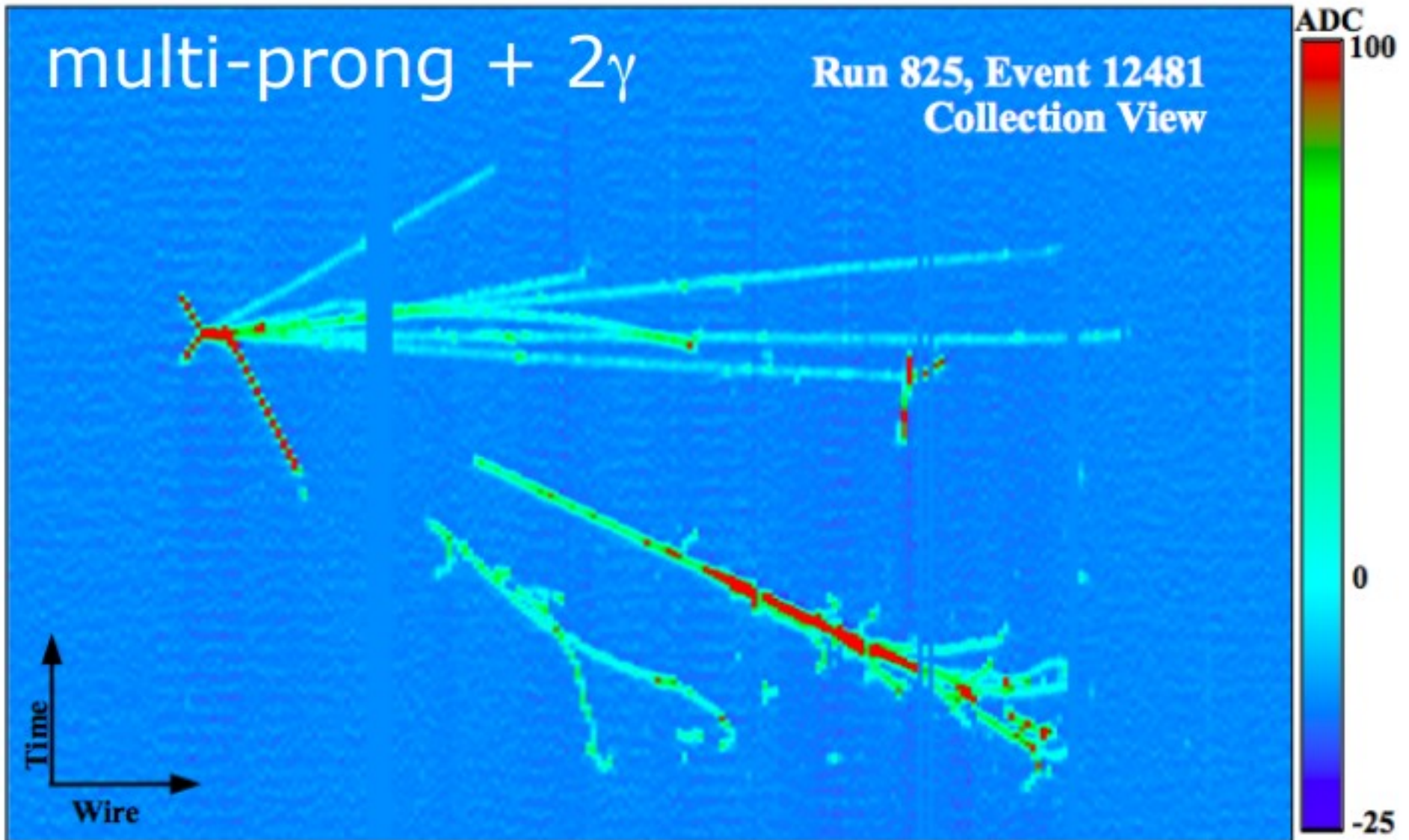

protoDUNE

WARWICK
THE UNIVERSITY OF WARWICK

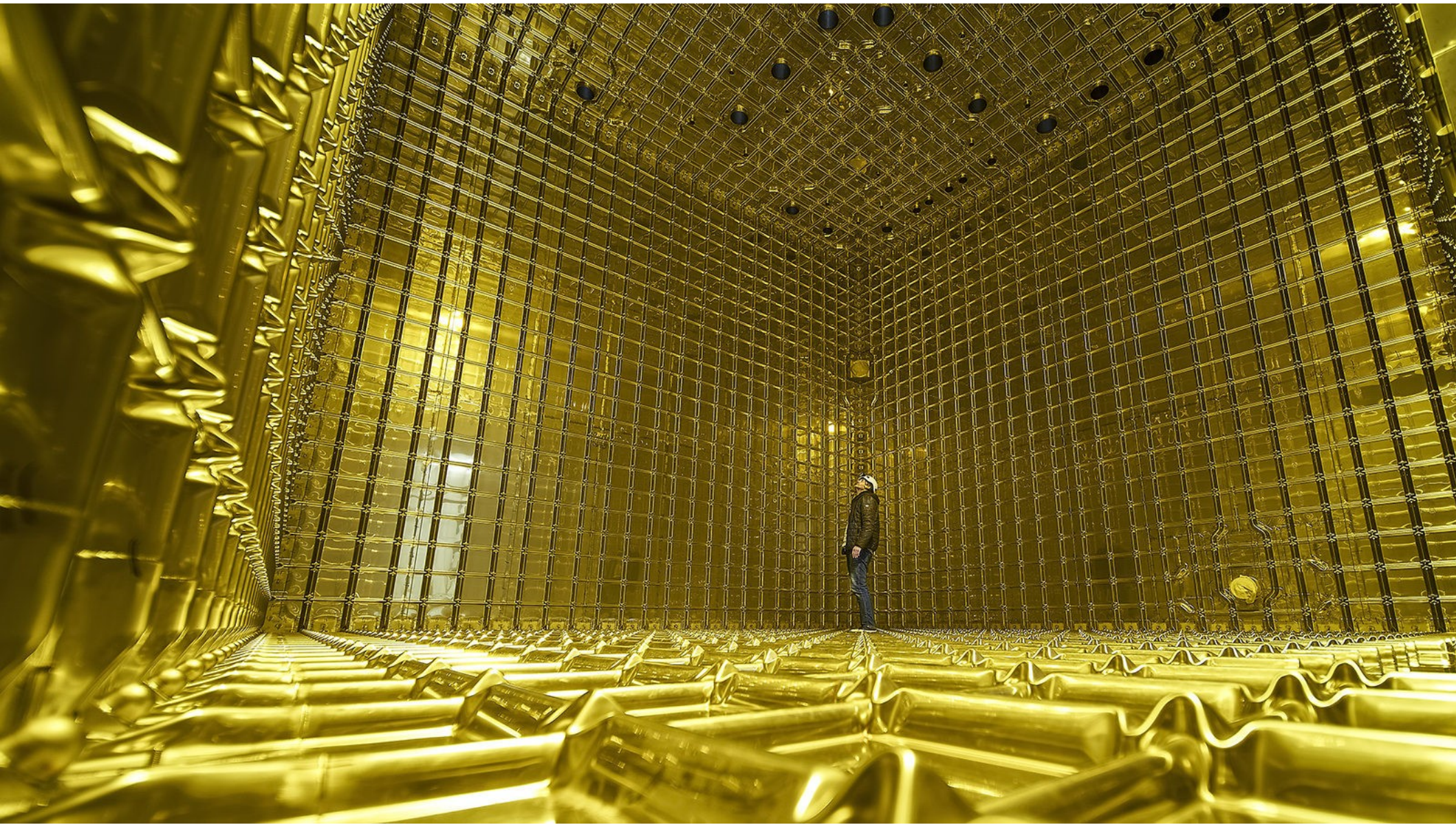

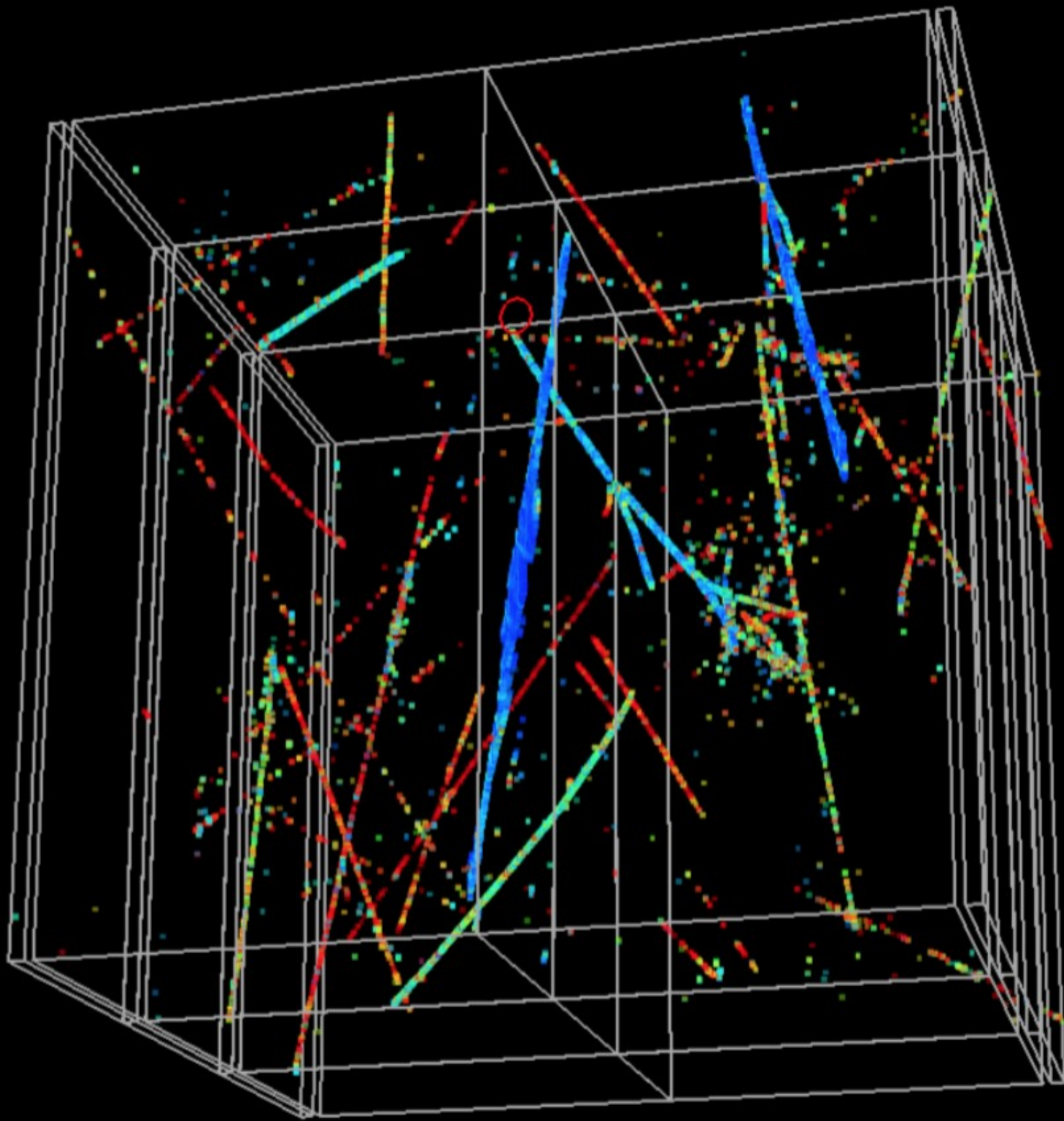

PROTO **DUNE**

Summary

- Type of neutrino detectors depend on target, event rate, and interaction type and cost
- 4 “main” techniques
 - radiochemical (low threshold but no direction or timing information - sub-MeV neutrinos)
 - water cerenkov (high threshold, cheap target mass, direction and timing but only low multiplicity events - 100 MeV up to a few GeV)
 - scintillator (no threshold but no directionality unless enhanced by water cerenkov - few MeV)
 - tracking calorimeters (high energy events - full reconstruction of events - 1 GeV and up)