

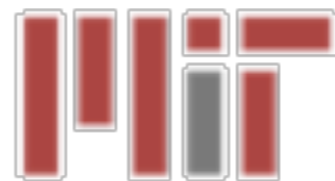

# Dark Matter Theory Overview

Tracy Slatyer



Topics in Astroparticle and Underground Physics  
Laurentian University, Sudbury  
24 July 2017

# Outline

Disclaimer: this is a broad overview + survey of selected topics,  
not a comprehensive review!

- The parameter space of possible dark matter models
- Thermal freezeout as a benchmark
  - Where do WIMPs stand?
  - Thermal relics beyond the weak scale
  - General constraints on thermal scenarios
- Beyond the thermal regime: light bosonic dark matter
- Primordial black holes as dark matter

# What is dark matter?

## We know it:

- Is roughly 80% of the matter in the universe.
- Isn't made up of any known particle (e.g. protons, electrons).
- Has mass (and hence gravity).
- Doesn't scatter/emit/absorb light (really "transparent matter"!).
- Interacts with other particles weakly or not at all (except by gravity).

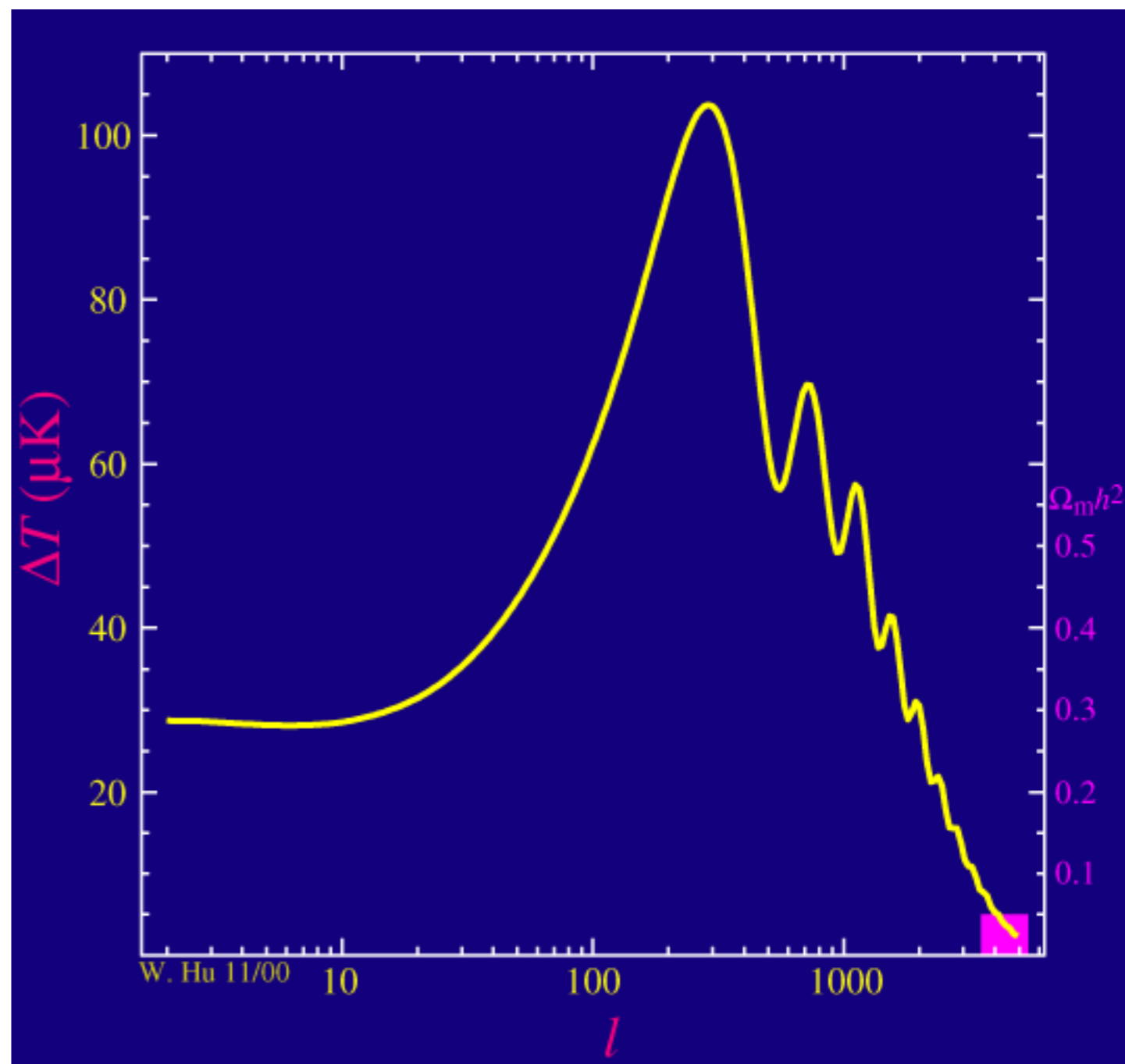

# What is dark matter?

## We know it:

- Is roughly 80% of the matter in the universe.
- Isn't made up of any known particle (e.g. protons, electrons).
- Has mass (and hence gravity).
- Doesn't scatter/emit/absorb light (really "transparent matter"!).
- Interacts with other particles weakly or not at all (except by gravity).

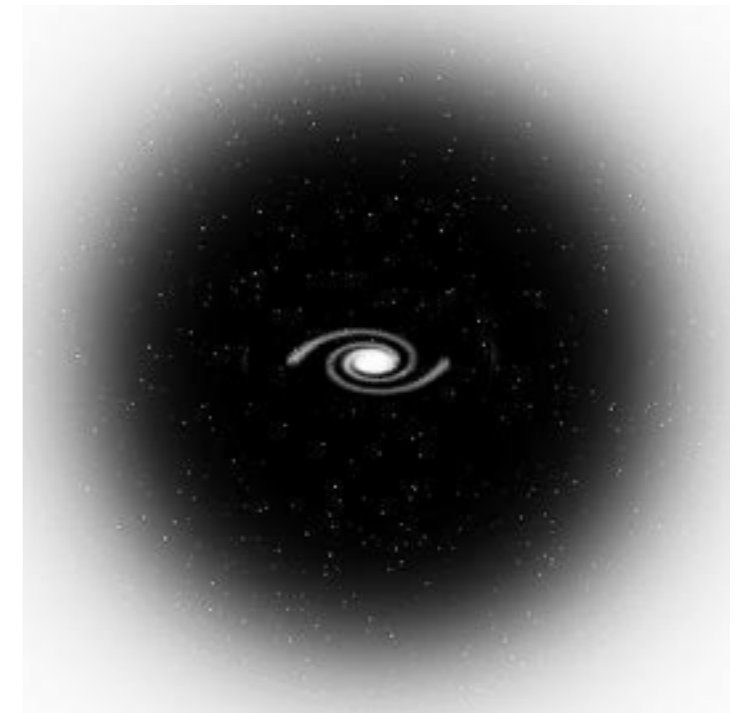

# What is dark matter?

## We know it:

- Is roughly 80% of the matter in the universe.
- Isn't made up of any known particle (e.g. protons, electrons).
- Has mass (and hence gravity).
- Doesn't scatter/emit/absorb light (really "transparent matter"!).
- Interacts with other particles weakly or not at all (except by gravity).

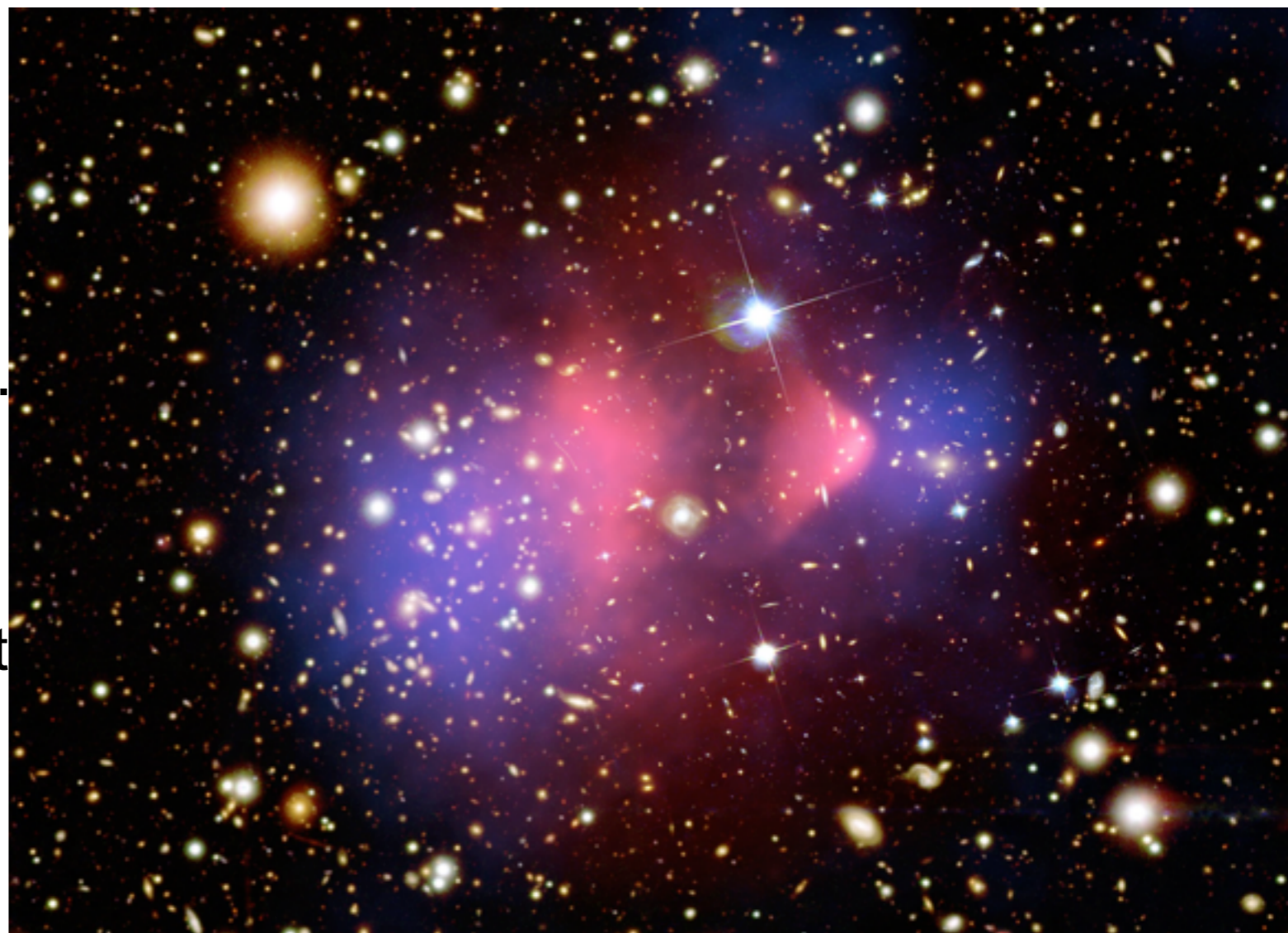

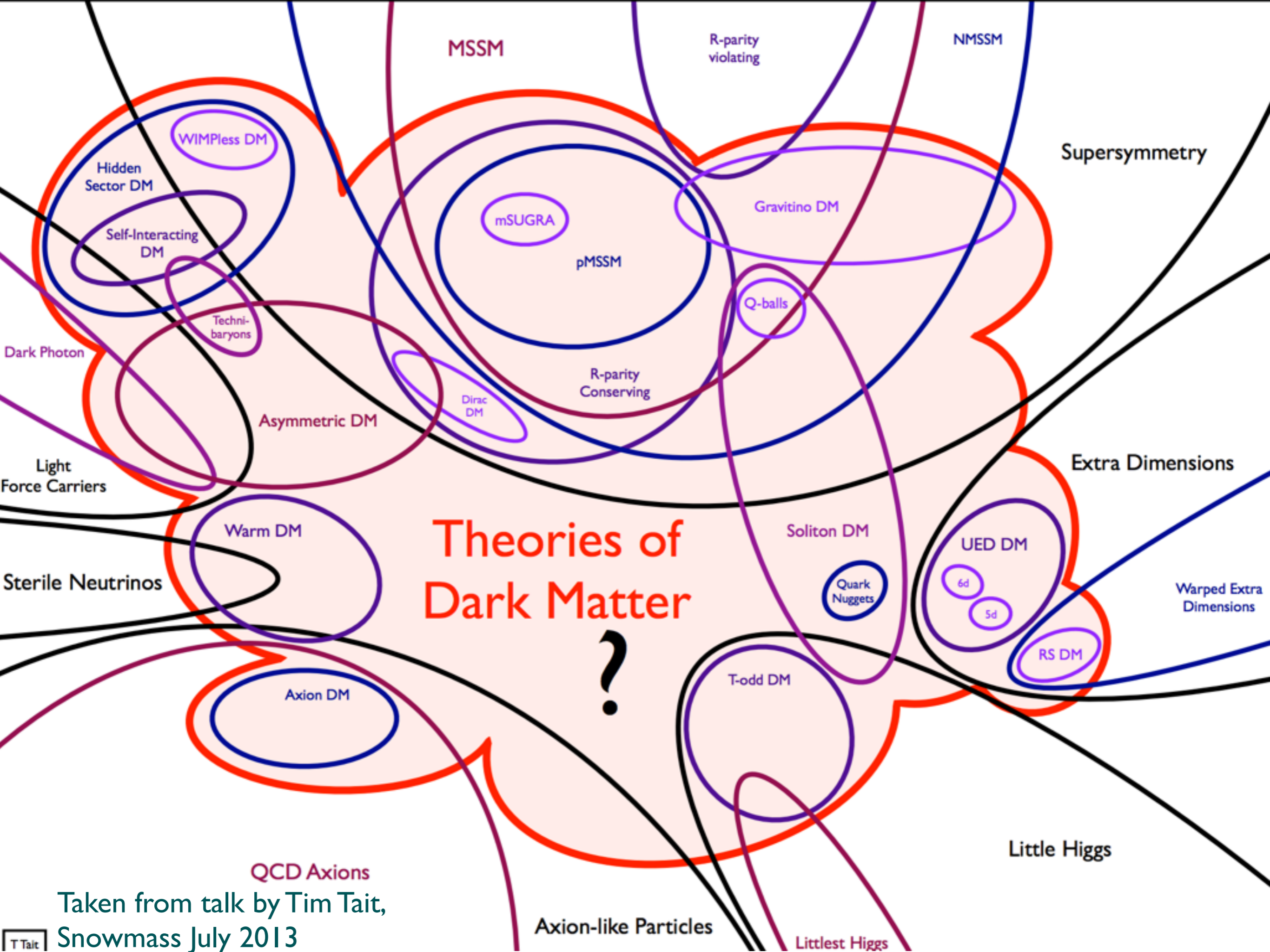

# Theories of Dark Matter

?

Taken from talk by Tim Tait, Snowmass July 2013

# Dark matter mass scales

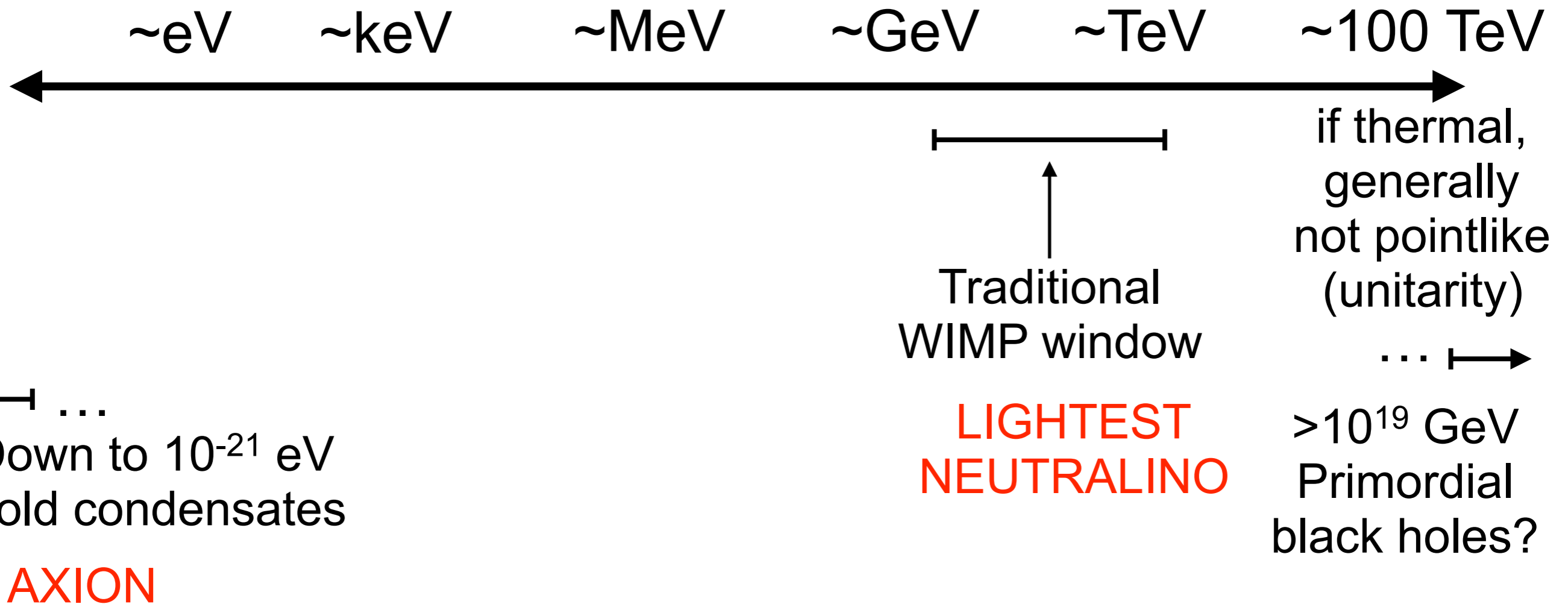

# Dark matter mass scales

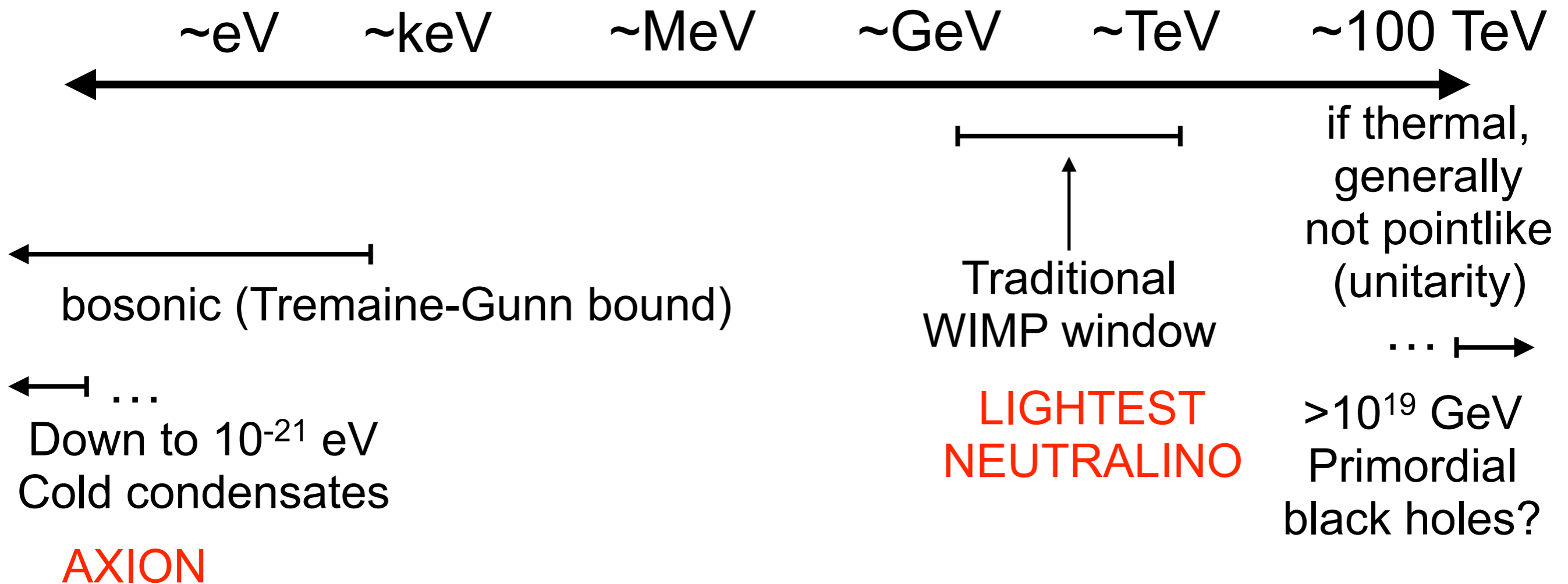



# Dark matter mass scales

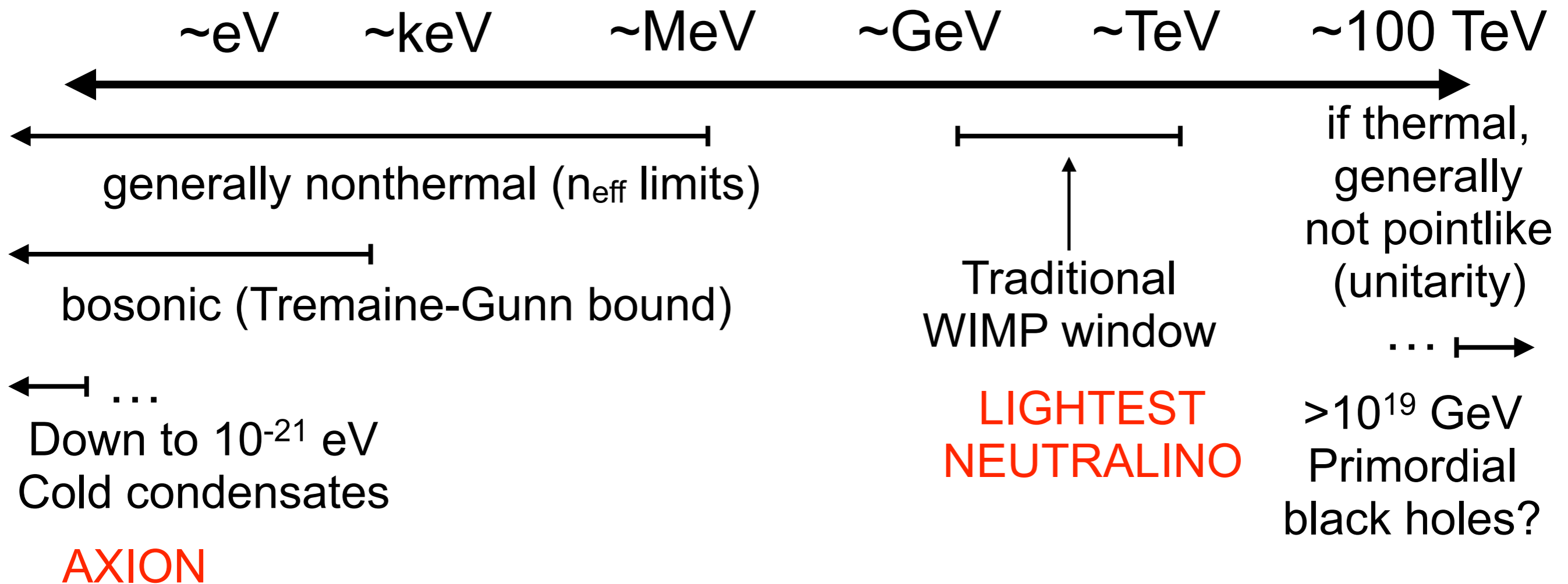

# Dark matter mass scales

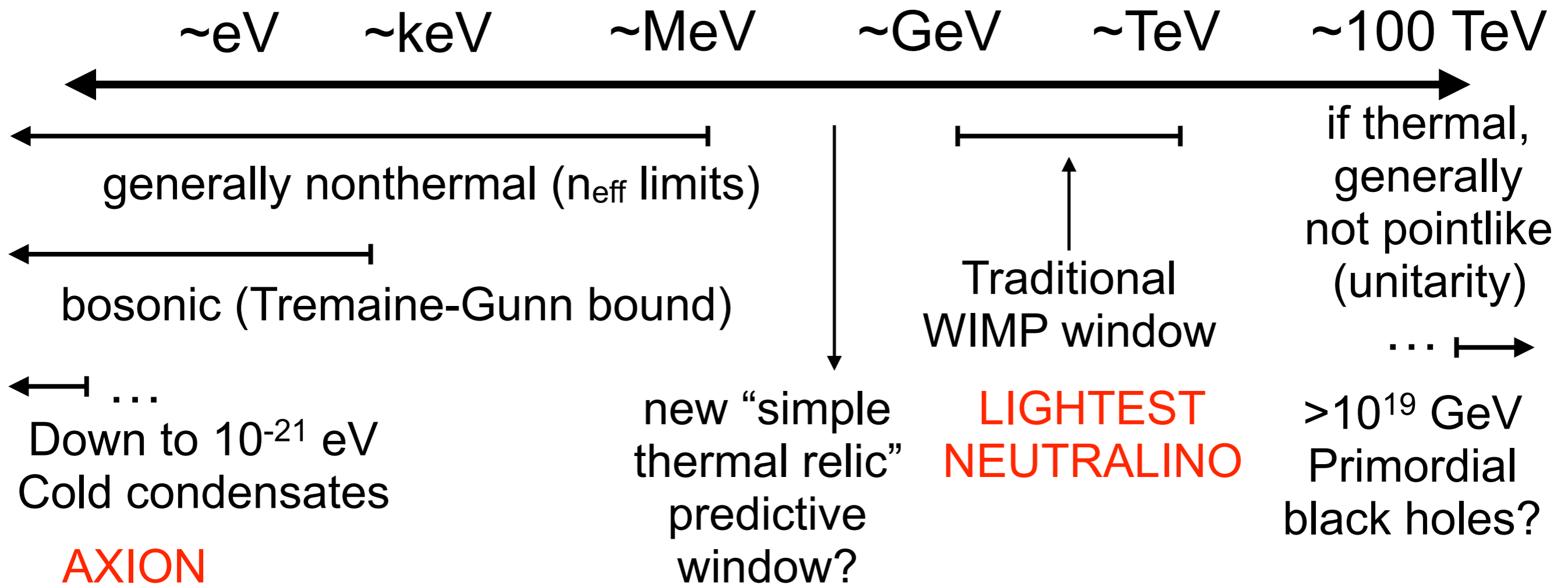

# Thermal freezeout

- In the early universe, suppose DM & Standard Model (SM) particles are in thermal equilibrium.
- DM can annihilate to SM particles, or SM particles can collide and produce DM.



- Temperature(universe) < particle mass => DM can still annihilate, but can't be produced.



- Abundance falls exponentially, cut off when timescale for annihilation  $\sim$  Hubble time. The comoving dark matter density then freezes out.

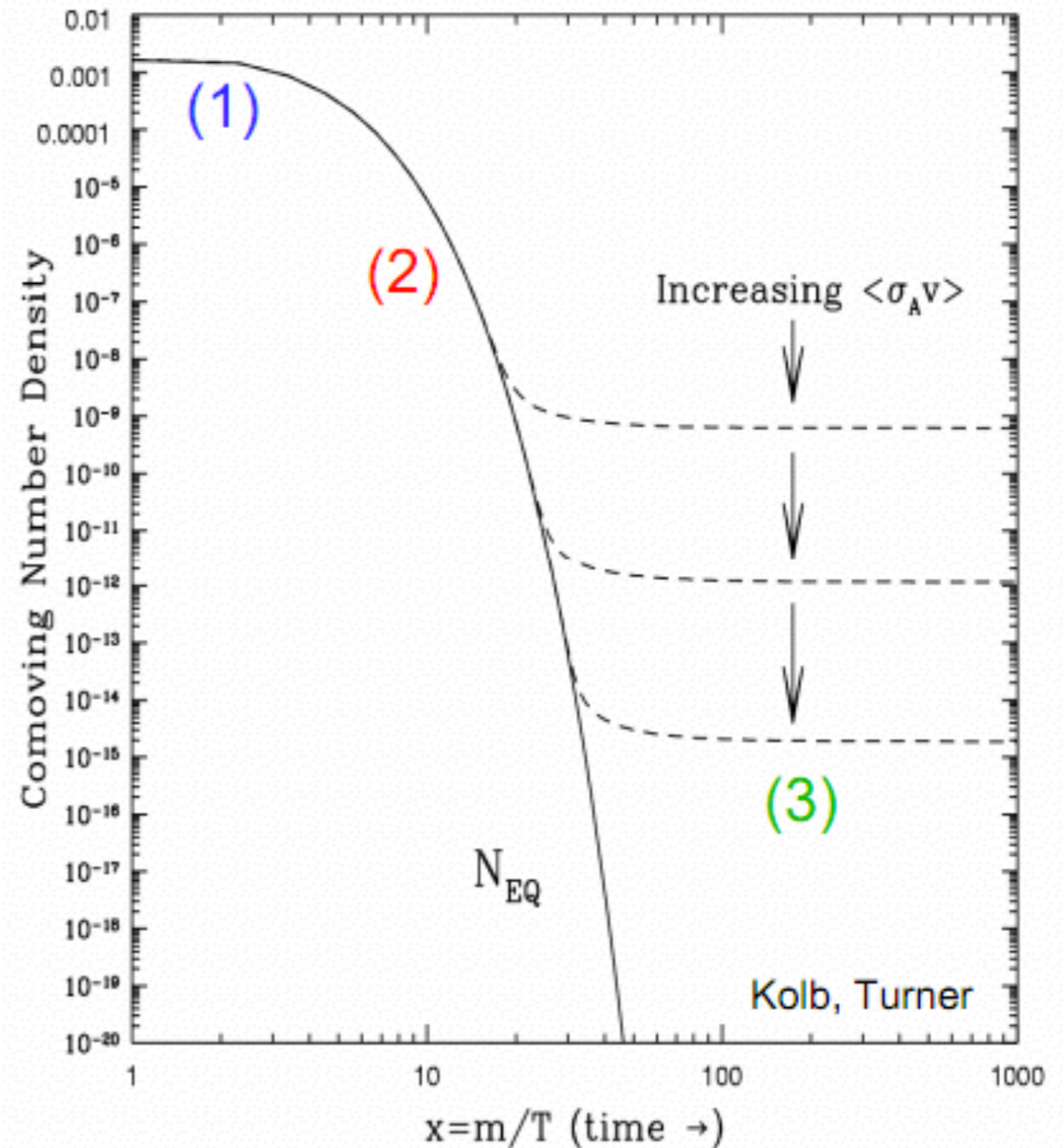

(3)

# The WIMP miracle

$$n_f \langle \sigma v \rangle \sim H \sim T_f^2 / m_{\text{Planck}} \sim m_\chi^2 / m_{\text{Planck}}$$

$$n_f = \rho_f / m_\chi \sim (m_\chi / T_{\text{eq}})^3 \rho_{\text{eq}} / m_\chi \sim m_\chi^2 T_{\text{eq}}$$

$$\langle \sigma v \rangle \sim \frac{1}{m_{\text{Planck}} T_{\text{eq}}} \sim \frac{1}{(10^{19} \text{GeV} \times 1 \text{eV})} \sim \frac{1}{(10^{14} \text{eV})^2}$$
$$\sim \frac{1}{(100 \text{TeV})^2} \sim \left( \frac{10^{-2}}{1 \text{TeV}} \right)^2 \sim \frac{\alpha^2}{m_\chi^2}$$

- Perturbativity requires DM mass below  $\sim 100$  TeV (unitarity bound  $\sim 200$  TeV [von Harling & Petraki '14]). Some caveats exist: e.g. late-time entropy injection can relax bound by many orders of magnitude [Bramante & Unwin '17].
- The thermal cross section is naturally obtained for electroweak-scale couplings and masses - suggests a possible connection to electroweak physics + hierarchy problem.

# WIMP searches

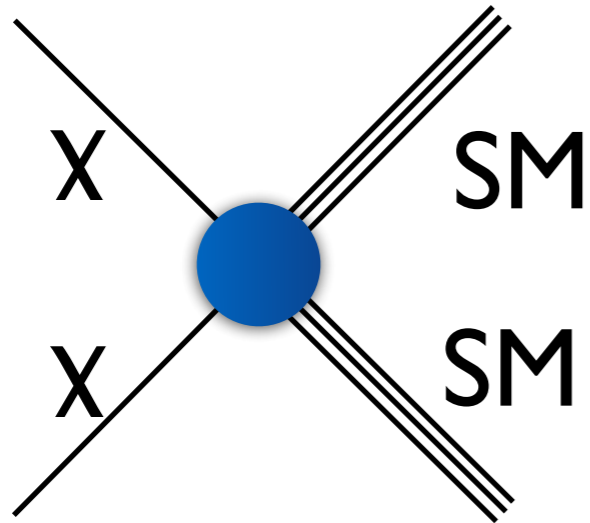

Indirect detection

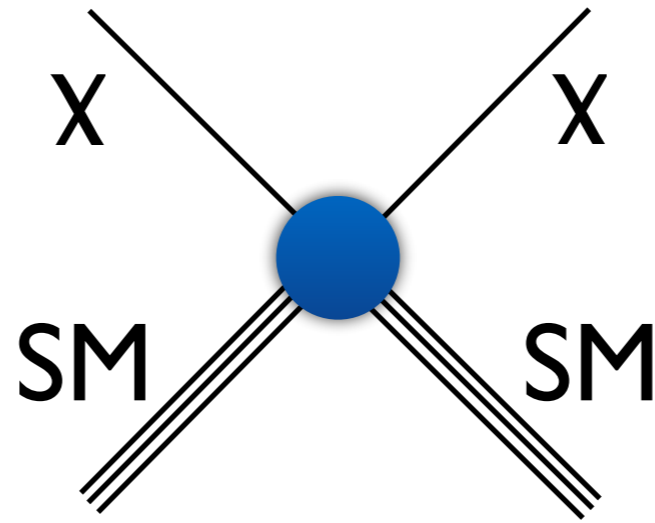

Direct detection

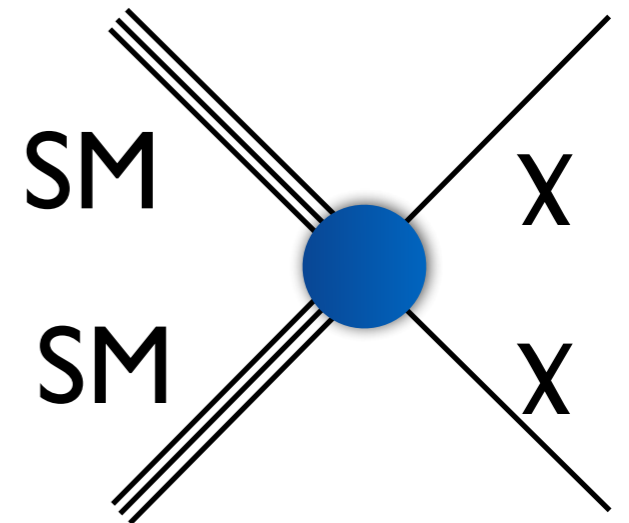

Collider

Time  
→

- Indirect detection: look for SM particles - electrons/positrons, photons, neutrinos, protons/antiprotons - produced by DM interactions.
- Direct detection: look for Standard Model particles recoiling from collisions with invisible dark matter.
- Colliders: produce DM particles in high-energy collisions and look for missing energy (e.g. at the LHC), or search for new light dark-sector particles.

# WIMP searches

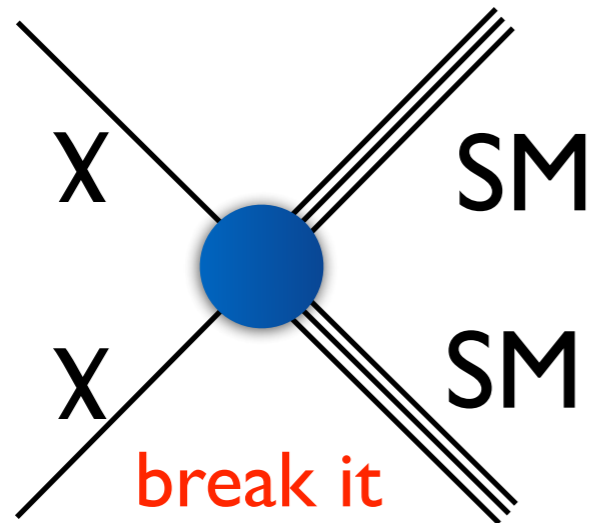

Indirect detection

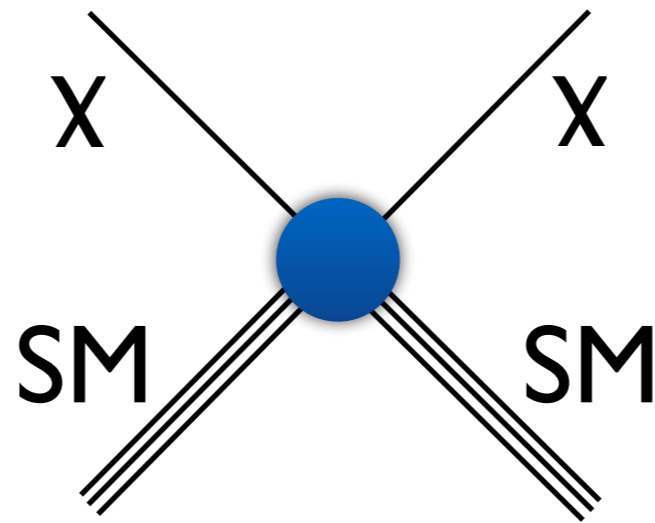

Direct detection

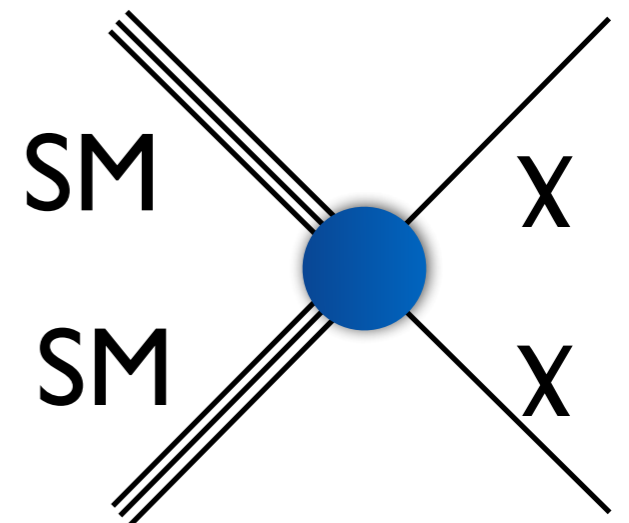

Collider

Time →

- Indirect detection: look for SM particles - electrons/positrons, photons, neutrinos, protons/antiprotons - produced by DM interactions.
- Direct detection: look for Standard Model particles recoiling from collisions with invisible dark matter.
- Colliders: produce DM particles in high-energy collisions and look for missing energy (e.g. at the LHC), or search for new light dark-sector particles.

# WIMP searches

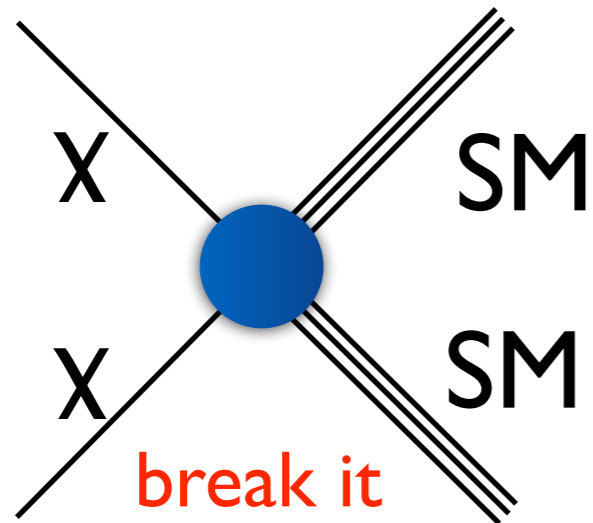

Indirect detection

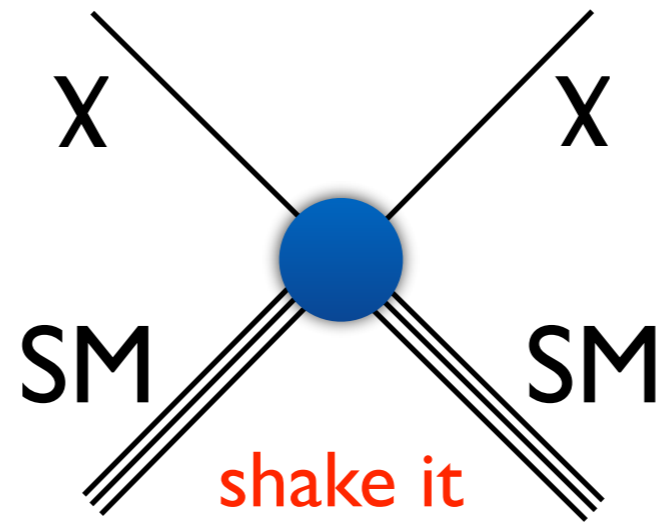

Direct detection

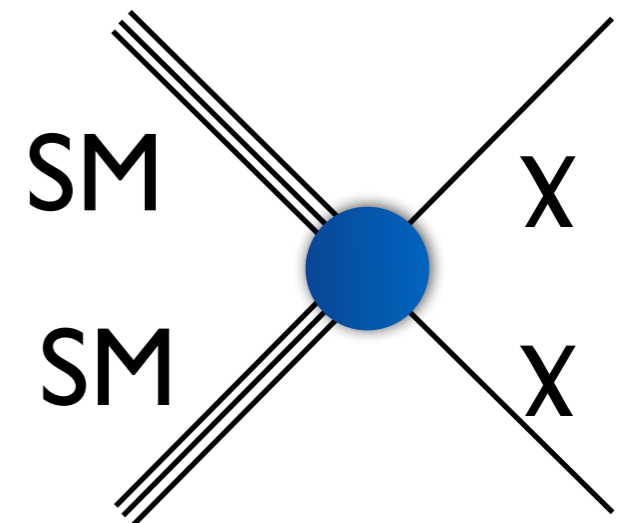

Collider

Time  
→

- Indirect detection: look for SM particles - electrons/positrons, photons, neutrinos, protons/antiprotons - produced by DM interactions.
- Direct detection: look for Standard Model particles recoiling from collisions with invisible dark matter.
- Colliders: produce DM particles in high-energy collisions and look for missing energy (e.g. at the LHC), or search for new light dark-sector particles.

# WIMP searches

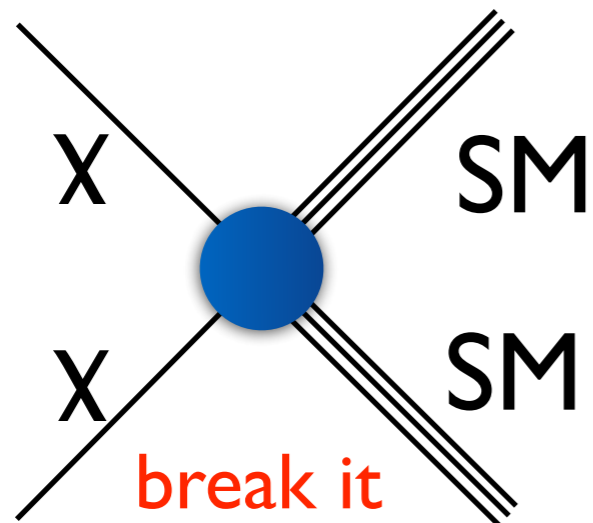

Indirect detection

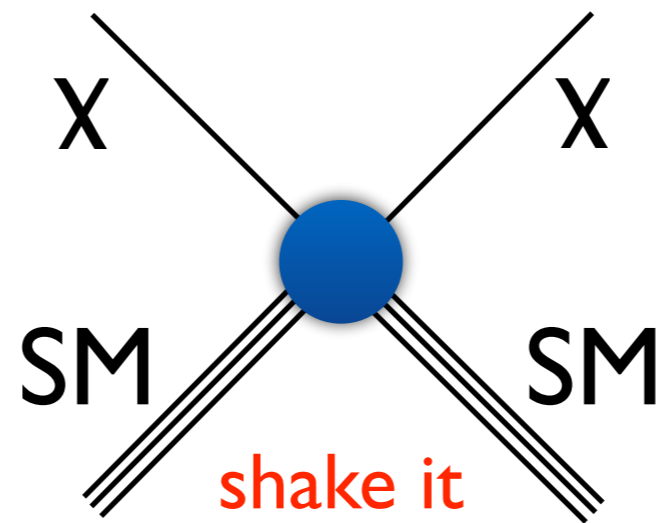

Direct detection

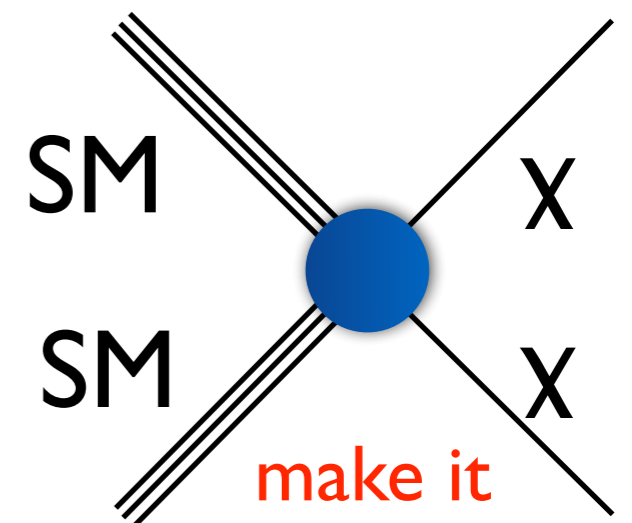

Collider

Time  
→

- Indirect detection: look for SM particles - electrons/positrons, photons, neutrinos, protons/antiprotons - produced by DM interactions.
- Direct detection: look for Standard Model particles recoiling from collisions with invisible dark matter.
- Colliders: produce DM particles in high-energy collisions and look for missing energy (e.g. at the LHC), or search for new light dark-sector particles.



# WIMPs under threat?

- No detection (yet) of new weak-scale physics at the LHC.
- No detection (yet) of WIMPs in direct or indirect dark matter searches - direct searches probing cross sections as small as  $10^{-46}$  cm<sup>2</sup> (LUX Collaboration '17).
- Can we exclude thermal relic dark matter where:
  - The DM transforms under the gauge groups of the Standard Model, or
  - The DM simply has roughly weak-scale masses and couplings?

# Example: the lightest SUSY neutralino

- In supersymmetric models, lightest superpartner (LSP) is stabilized by R-parity.
- Typically the LSP is the lightest neutralino - admixture of wino, bino, and higgsino.
- Plot shows “relic density surface” where correct relic density is obtained, in terms of neutralino mass parameters  $M_1$ ,  $M_2$ ,  $\mu$ .
- Here all superpartners except neutralinos and charginos are assumed to be heavy and decouple.

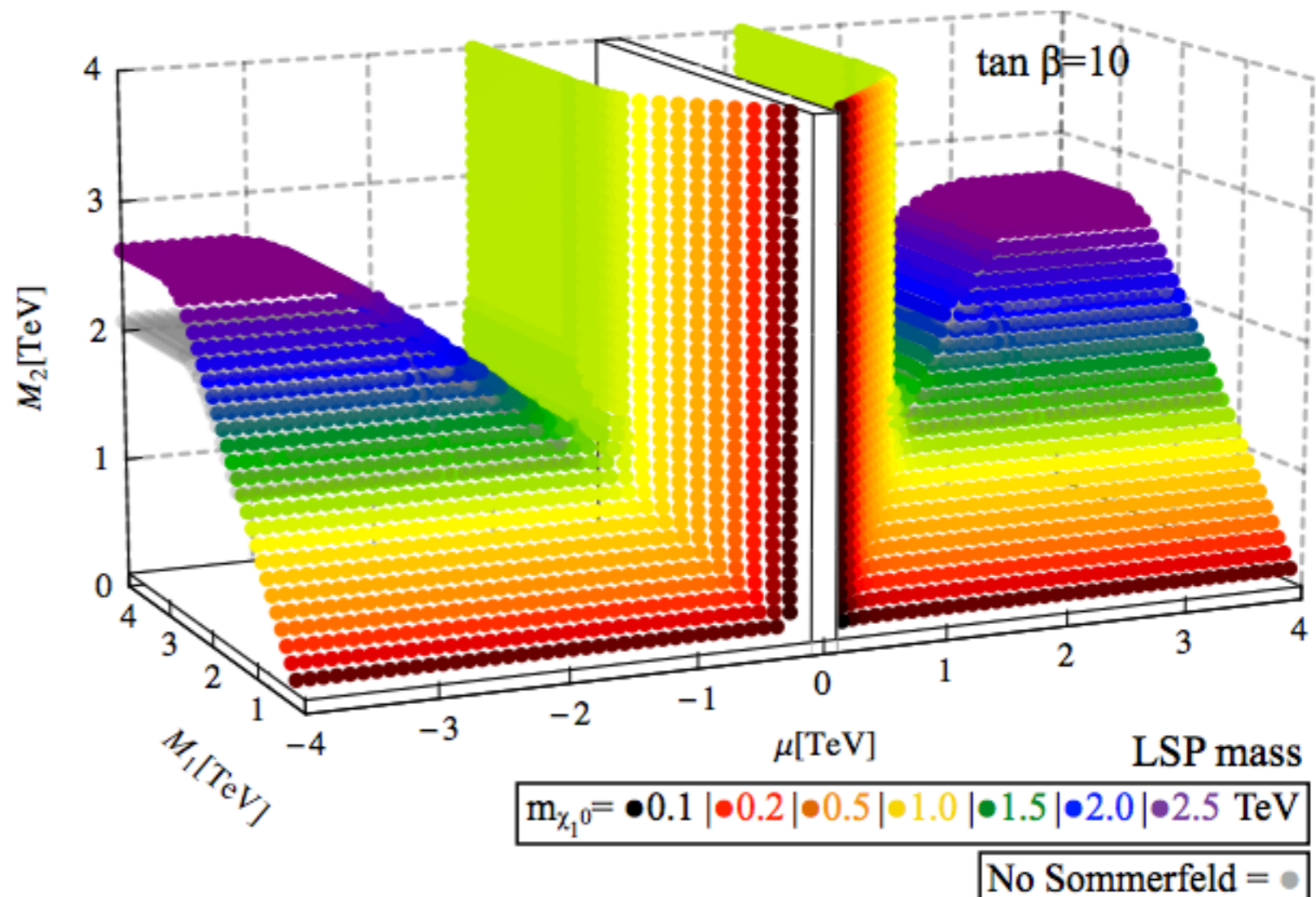

Bramante et al '16

# Example: the lightest SUSY neutralino

- In supersymmetric models, lightest superpartner (LSP) is stabilized by R-parity.
- Typically the LSP is the lightest neutralino - admixture of wino, bino, and higgsino.
- Plot shows “relic density surface” where correct relic density is obtained, in terms of neutralino mass parameters  $M_1$ ,  $M_2$ ,  $\mu$ .
- Here all superpartners except neutralinos and charginos are assumed to be heavy and decouple.

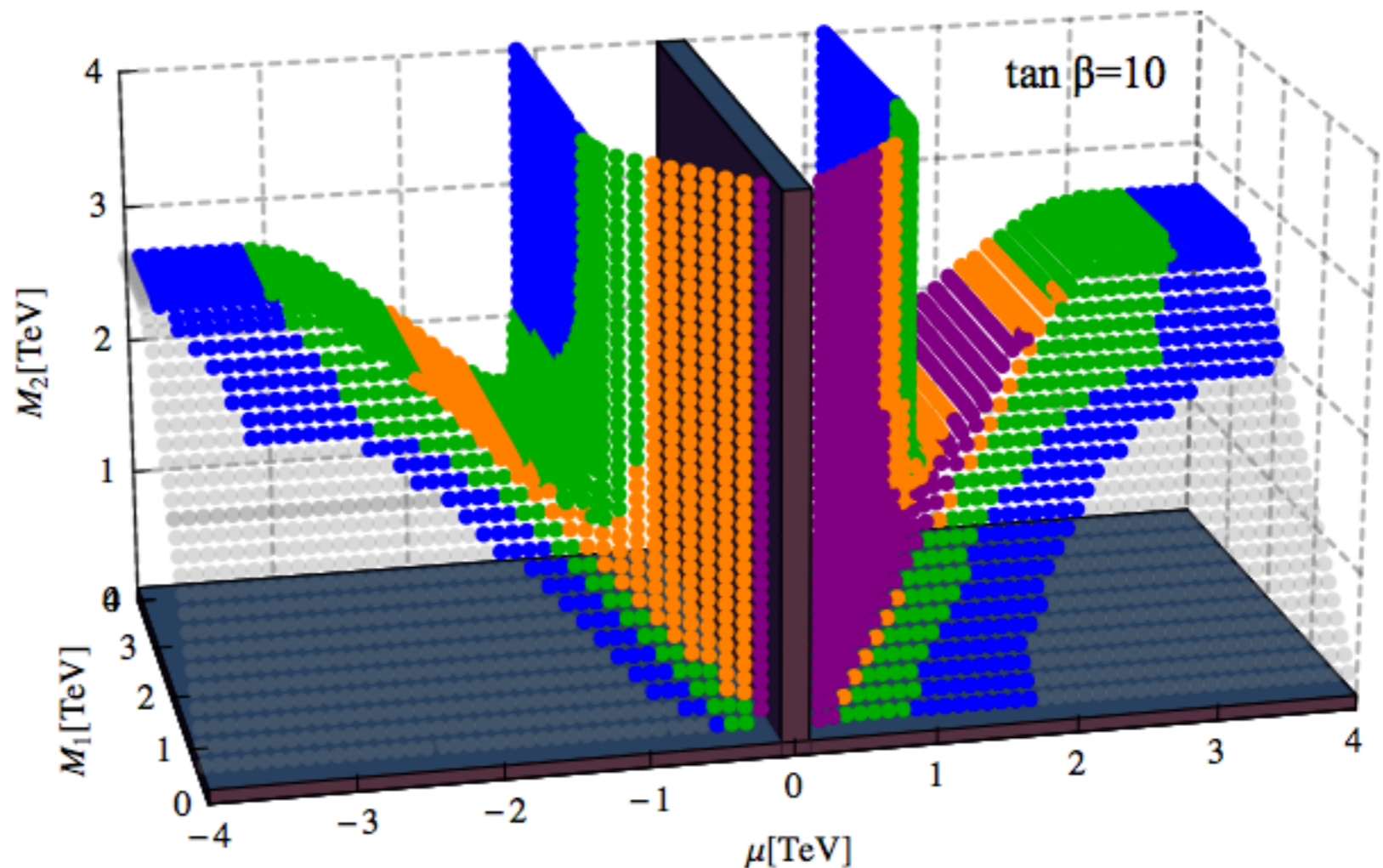

Excluded: XENON100 ● | LUX ●

Bramante et al '16

# Example: the lightest SUSY neutralino

Hill & Solon '14

- Current set of constraints leaves open swathes of parameter space:
  - Pure higgsinos and winos, and much of bino-wino parameter space, still yield predicted DD signals below current limits.
  - Current collider limits on pure winos (higgsinos) only rule out masses below  $\sim 400$  ( $\sim 100$ ) GeV [ATLAS-CONF-2017-017, Fukuda et al '17].
  - Heavy winos can be probed by indirect detection, but limits depend on the DM density profile of the Milky Way [e.g. Ovanesyan et al '17].

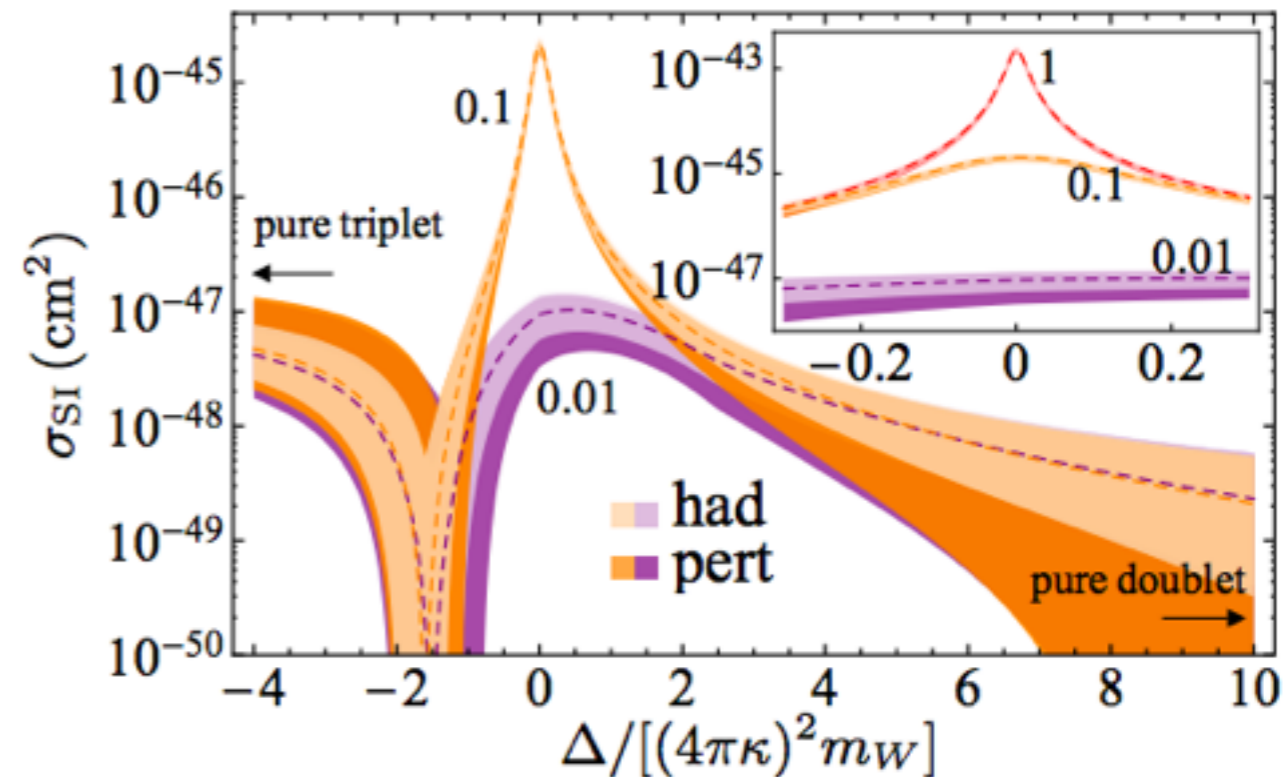
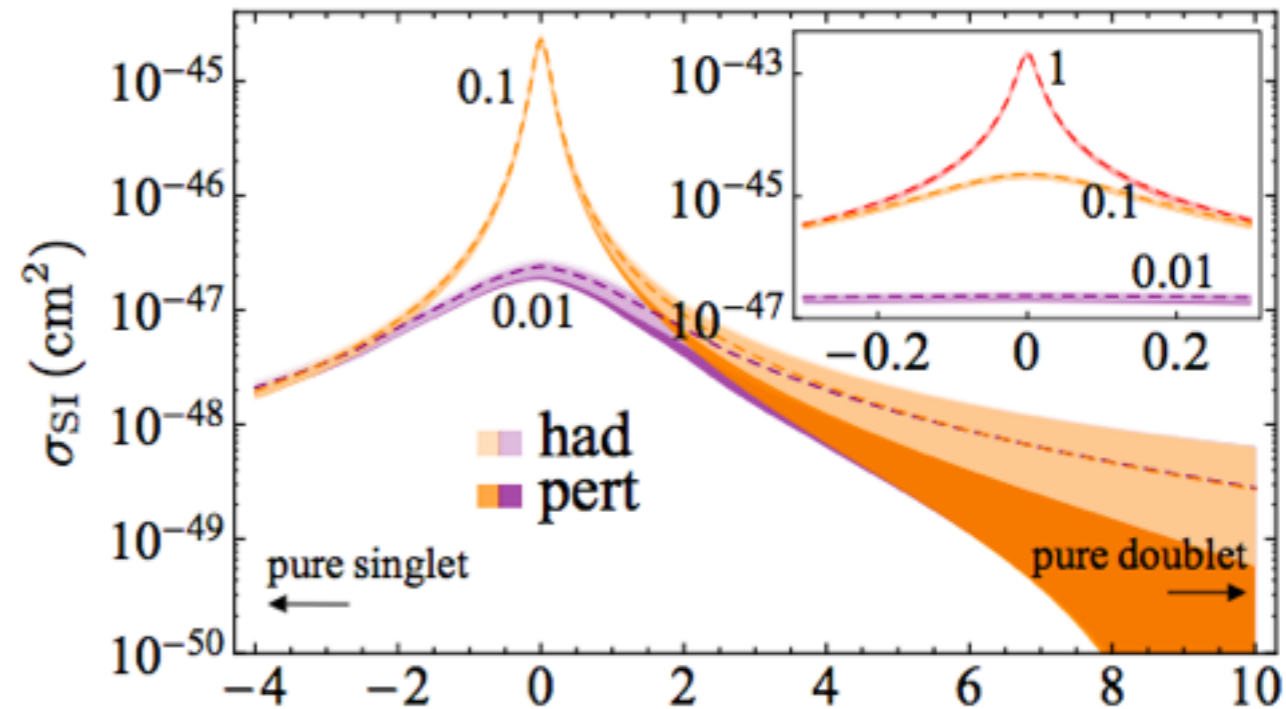

Predictions for direct detection of pure and mixed  $SU(2)_L$  DM

Limits on wino DM, ATLAS-CONF-2017-017

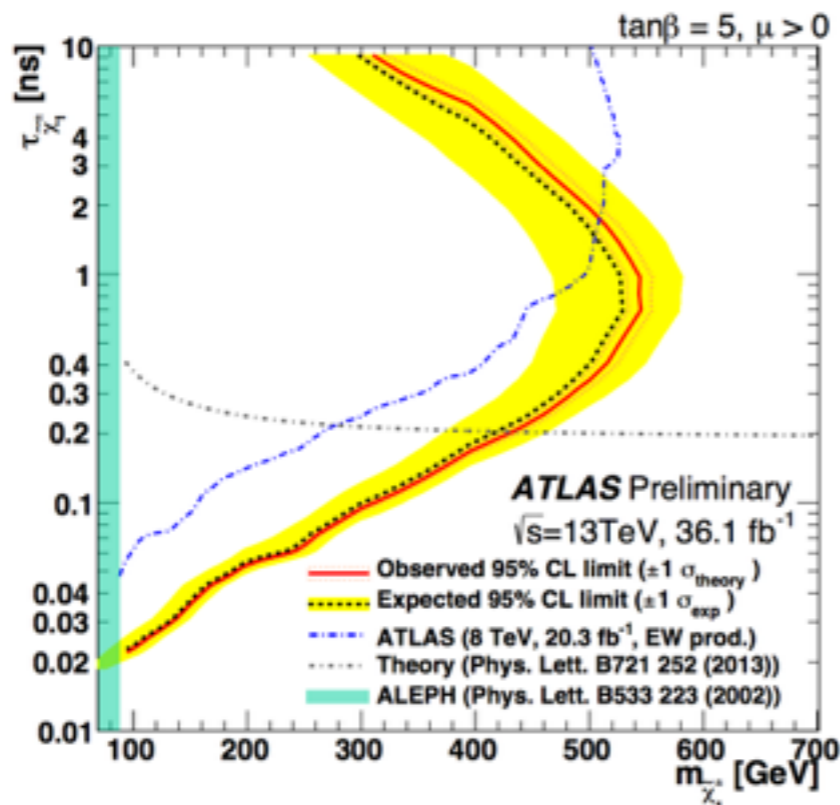

# Example: dark vector portal

- Dark matter couples to dark photon which mixes slightly with Standard Model photon:

$$\mathcal{L}_{\text{mix}} = \frac{\epsilon}{2} F^{\mu\nu} F_{\mu\nu}^D$$

- Direct and collider signatures are suppressed by small mixing.
- Relic density almost unaffected by small mixing if DM is heavier than dark photon.
- Can search with indirect detection, or by direct probes of the dark mediator - stringent limits for light dark photons and up to 100 TeV DM [Cirelli et al '17].

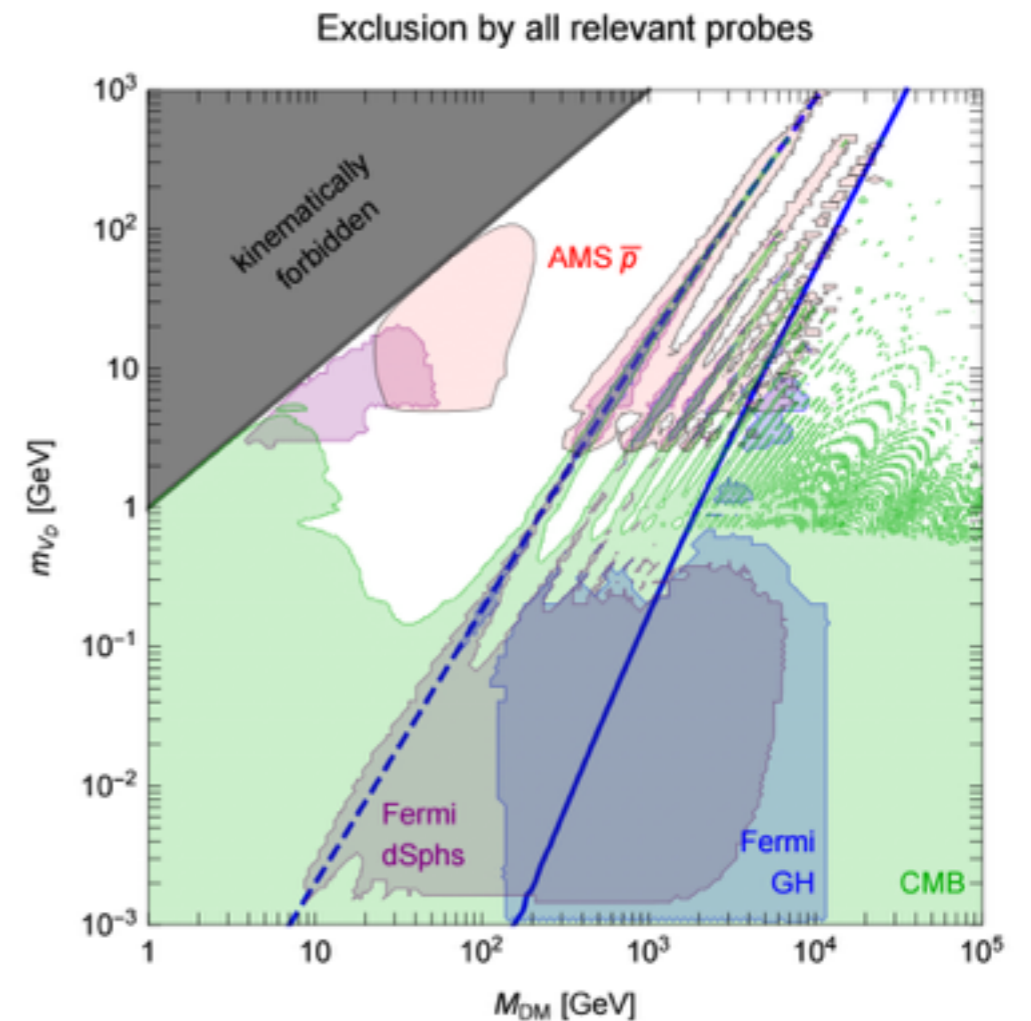

dominant annihilation channel

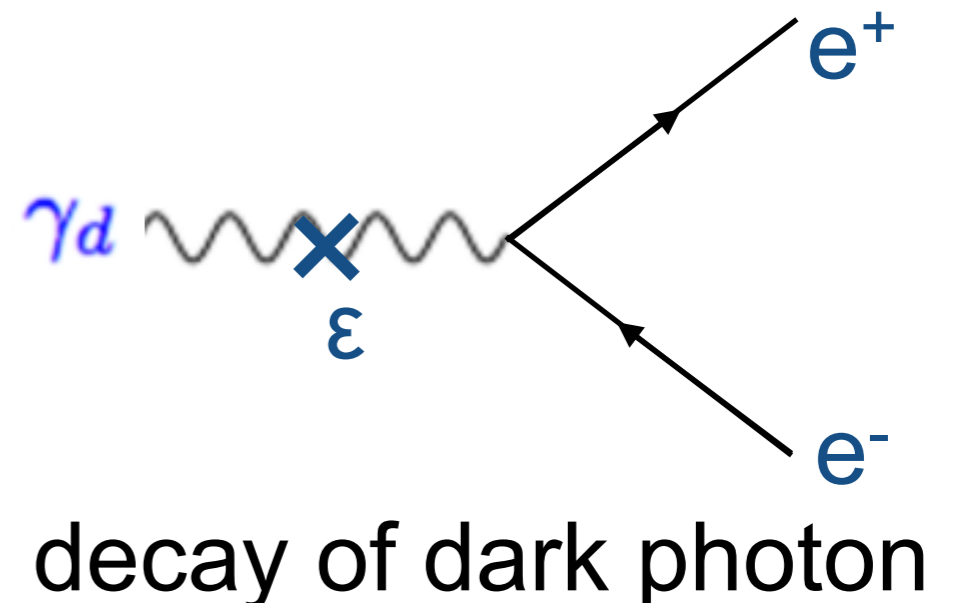
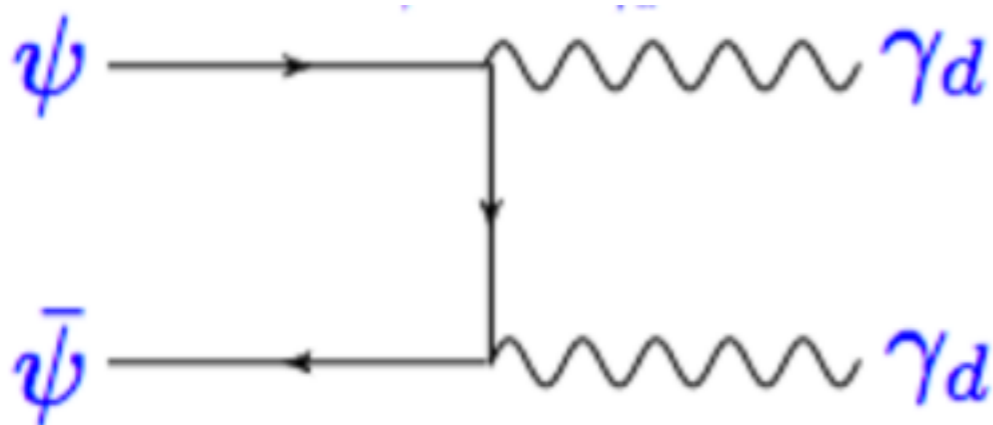

# Broader benchmarks

- General symmetry arguments allow various “portals” between dark sector (containing DM) and Standard Model. Reasonable to expect modest DM-SM couplings.
- Hypothesis: DM-SM couplings play a role in determining the present-day DM abundance. Example mechanisms:
  - Thermal freezeout: as in WIMP case.
  - Asymmetric dark matter [Kaplan et al '09]: relic abundance is set by initial asymmetry, but a large annihilation cross section is required to deplete the symmetric component. Implies a lower bound on couplings.
  - Freeze-in [Hall et al '10]: DM is produced by collisions of thermal SM particles (but never achieves full thermal equilibrium). Implies larger abundances for stronger couplings, in contrast to freeze-out. Generally requires very small couplings.
  - SIMP/ELDER/secluded scenarios [Hochberg et al '14, Kuflik et al '16]: DM depletion occurs within a separate hidden sector, but couplings to SM determine when/whether the hidden sector can transfer entropy into the SM photon bath.
- Each of these mechanisms is predictive - re-examine complementarity between direct/indirect/accelerator searches for different relic density mechanisms, masses below the WIMP window. (See Battaglieri et al '17, Cosmic Visions report, for much greater detail!)

# Challenges for light thermal dark matter

- Many new ideas for experimental dark matter searches in the keV-GeV mass range - direct detection, beam dumps, fixed-target experiments, MeV-GeV gamma-ray telescopes, etc.
- But also many existing constraints!
- Most model-independent bounds on thermal relic annihilation rate come from indirect detection.
- Example: too large an annihilation rate producing photons/electrons during the cosmic dark ages leads to extra ionization - perturbs the CMB.
- Thermal annihilation cross section during this epoch is ruled out for DM masses below 1 GeV, unless DM annihilates mostly/entirely to neutrinos.

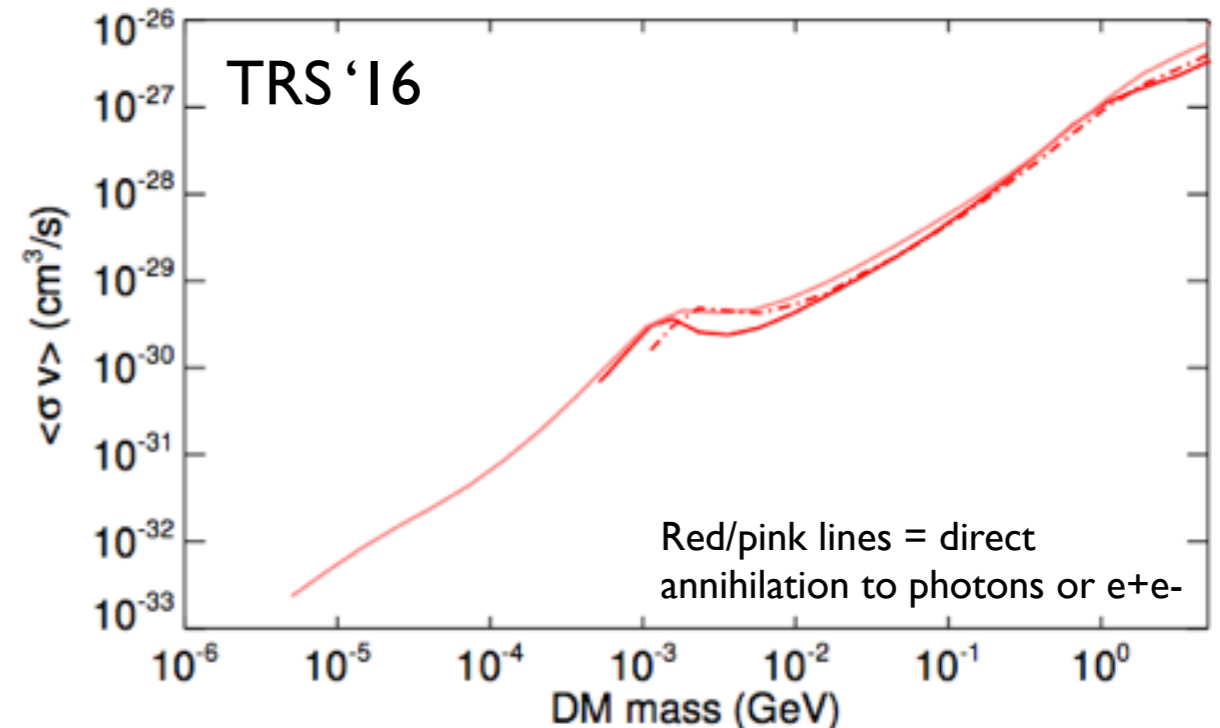
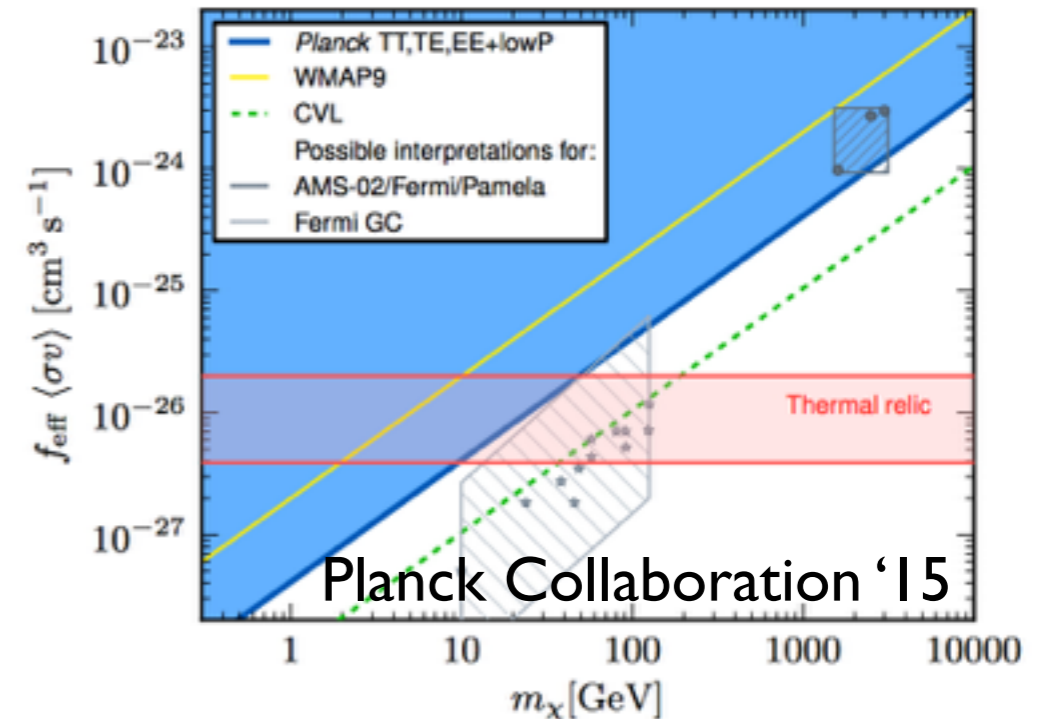

# Examples: light thermal DM

- Some examples of theoretical models with thermal freezeout, which yield the correct relic density with extremely suppressed annihilation at late times (to evade CMB and other indirect detection limits):
  - Dominantly p-wave annihilation: main annihilation channel is suppressed by  $(v/c)^2$ .
  - Annihilation against a partner particle which is not present at late times (e.g. because it decays).
  - Forbidden dark matter [d'Agnolo & Ruderman '15]: DM annihilates to heavier states, suppressing natural annihilation rate; annihilation is exponentially suppressed at DM temperatures much less than the mass splitting.
  - Impeded dark matter [Kopp, Liu, TRS, Wang & Xue]: DM annihilates to near-degenerate states; due to phase space suppression, annihilation rate is suppressed by  $(v/c)$  down to a cutoff velocity.
  - Strongly interacting massive particles [Hochberg et al '14], not-forbidden dark matter [Cline, Liu, TRS & Xue], assisted annihilation [Dey et al '17]:  $3 \rightarrow 2$  or  $4 \rightarrow 2$  number-changing processes within a dark sector dominate freezeout.
    - rate is naturally smaller due to stronger density dependence
    - natural mass for freezeout is  $m_\chi \sim \alpha \sqrt[n]{m_{\text{Planck}} T_{\text{eq}}^{n-1}}$
    - Suggests sub-GeV scale for  $3 \rightarrow 2$  processes, sub-MeV scale for  $4 \rightarrow 2$  processes.



# How low can (thermal) DM go?

- $n_{\text{eff}}$  bound: Big Bang nucleosynthesis (BBN) and CMB data constrain number of effective relativistic degrees of freedom.
- After electrons/positrons become non-relativistic, neutrinos have temperature  $(4/11)^{1/3} T_{\text{CMB}}$ ;  $\Delta n_{\text{eff}} = 1$  corresponds to the addition of one extra neutrino species (or other relativistic species at neutrino temperature).
- Planck 2015 data:  $n_{\text{eff}} = 3.15 \pm 0.23$  (Planck Collaboration '15).
- If DM is in thermal equilibrium with the Standard Model down to  $O(\text{MeV})$  temperatures,  $n_{\text{eff}}$  limit is generally violated [Nollett & Steigman '14, '15]:
  - If DM is still relativistic during BBN ( $T \sim 1 \text{ MeV}$ ), can increase  $n_{\text{eff}}$  directly (independent of coupling to SM).
  - If DM annihilates away after neutrinos decouple from photon bath ( $T \sim 1 \text{ MeV}$ ), either to photons or neutrinos, it can substantially modify the neutrino temperature relative to the photon temperature - alter  $n_{\text{eff}}$  indirectly.

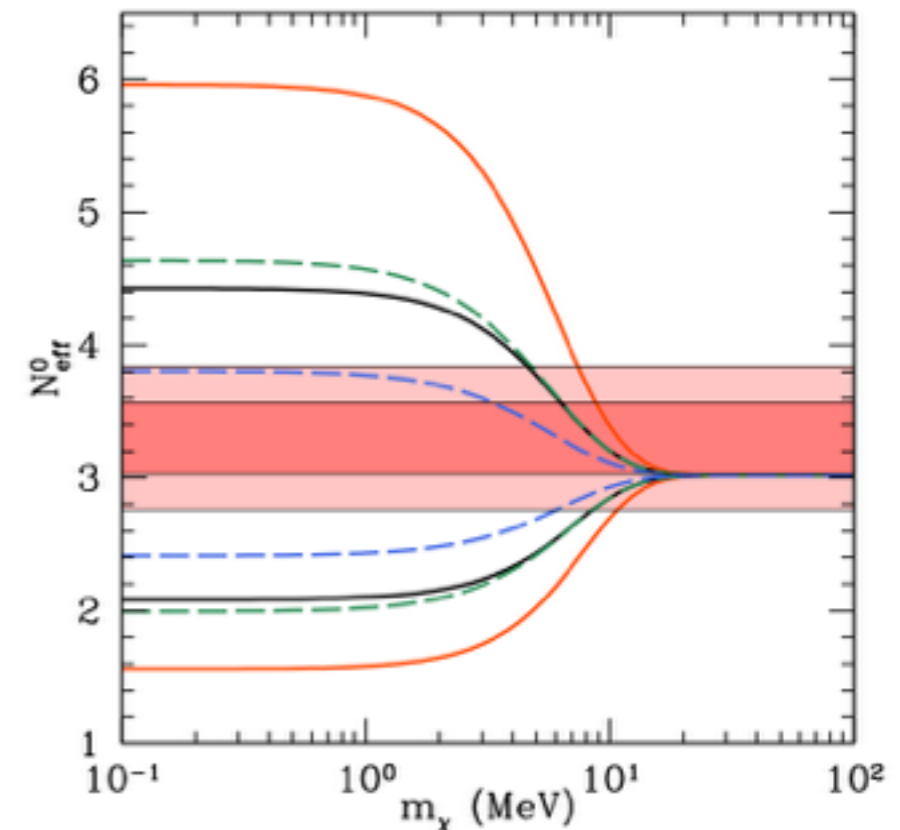

# How low can (thermal) DM go? (round II)

- $n_{\text{eff}}$  bound can be evaded if:
  - DM undergoes thermal freezeout to its own dark sector, which is not thermally coupled to the SM, and is colder (e.g. because this sector decoupled from SM before QCD phase transition [Green & Rajendran '17]).
  - DM first reaches thermal equilibrium with SM at temperatures below 1 MeV (after BBN), then decouples again before the CMB epoch [Berlin & Blinov '17].
- Additional limitation: DM itself cannot be too warm/hot during structure formation.
  - Bounds from Lyman-alpha forest exclude thermal DM below  $\sim 2\text{-}5$  keV [e.g. Garzilli et al '15, Irsic et al '17].
  - Limits relaxed for DM substantially colder than CMB photon bath - requires early thermal decoupling (or no thermal coupling at all).

# How low can DM (ultimately) go?

- Minimum DM mass scale: de Broglie wavelength of DM must be smaller than size of smallest observed DM structures.
- Dwarf galaxies: size  $O(\text{kpc})$ , typical velocity dispersion  $O(10) \text{ km/s}$ .
- DM mass of  $10^{-22} \text{ eV} \Rightarrow$  de Broglie wavelength  $\sim \text{kpc}$ .
- Lower-mass DM would not allow for observed dwarf galaxies.

Irsic et al '17

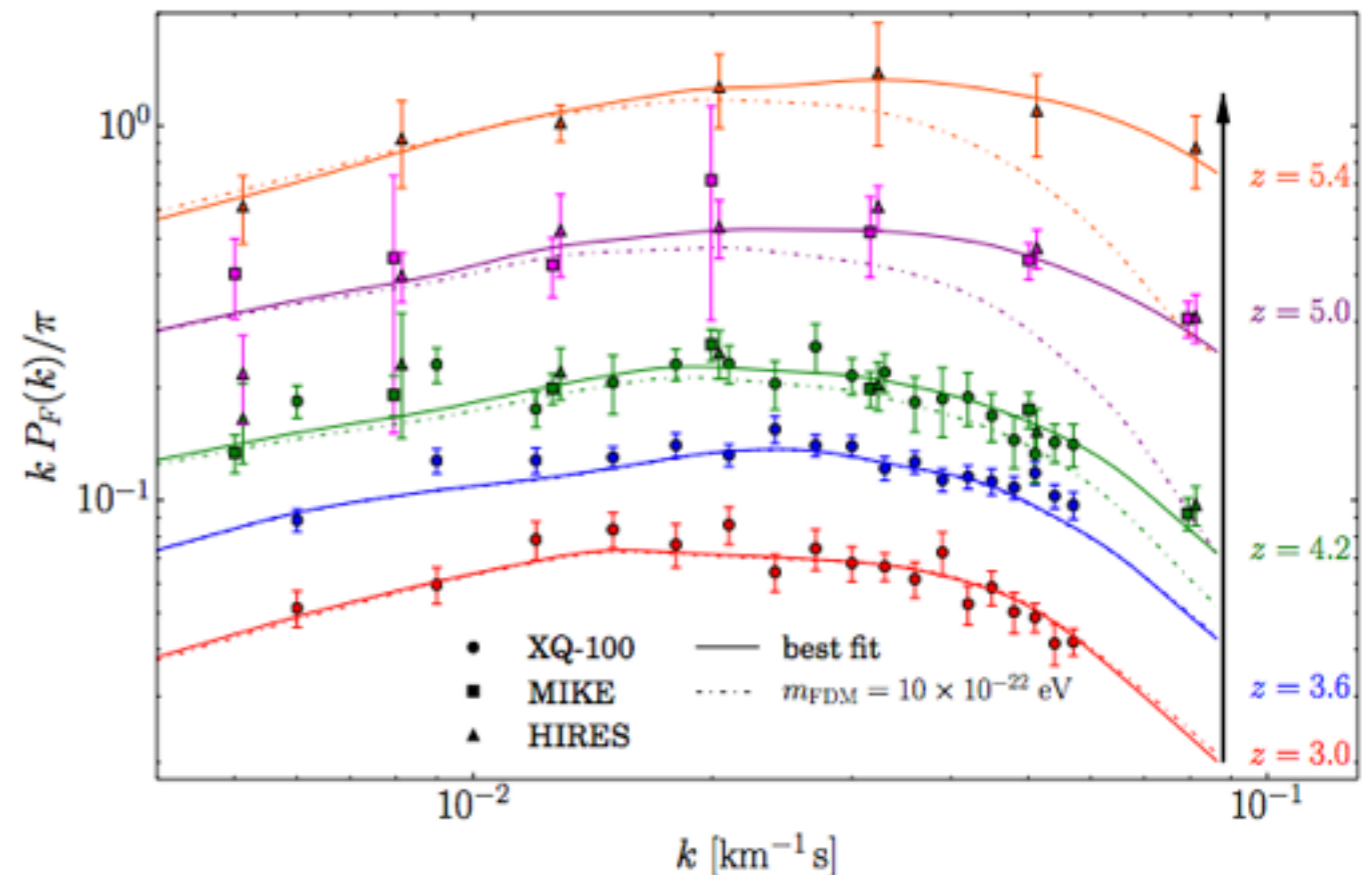

- We can do better: Lyman-alpha forest data constrain cutoff in the matter power spectrum, require that  $m_{\text{DM}} > 2-3 \times 10^{-21} \text{ eV}$  [Irsic et al '17, Armengaud et al '17].
- There are many proposed experiments to search for axions, axion-like particles, or very light dark photons (see e.g. Cosmic Visions '17 report).

# Light bosonic dark matter

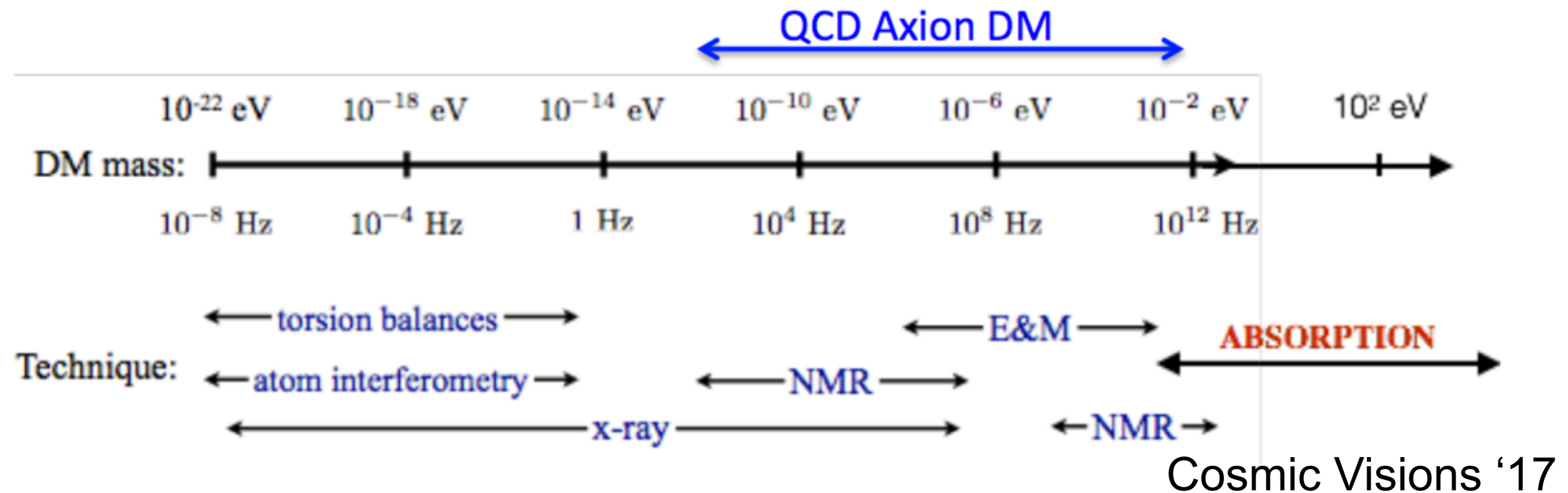

- Two main parameter regions for sub-keV bosonic dark matter
  - meV-keV: DM can be absorbed onto target electrons in semiconductors or superconductors via phonon emission [Hochberg, Lin & Zurek '16-'17, Bloch et al '16]
  - $10^{-21}$  eV - meV: DM can be regarded as coherently oscillating classical field, opens up a range of new detection methods targeting continuous wave signals (rather than individual particles).

# The high mass scale: status of MACHOs

- Primordial black holes (BHs) with masses above  $\sim 10^{14}$  g could constitute a possible DM candidate.
- Below  $\sim 10^{-15}$  solar masses, gamma-rays from BH evaporation are excluded for BHs constituting 100% of DM.
- Limits on femtolensing of gamma-ray bursts and interaction of black holes with neutron stars/white dwarfs constrains the  $10^{-16}$ - $10^{-10}$  solar mass window.
- Microlensing surveys rule out 100% of DM being  $10^{-7}$ - $10$  solar mass BHs.
- (Lack of) dynamical heating of star clusters and ultrafaint dwarf galaxies constrains heavier BHs - together they appear to exclude  $10^{-7}$ - $10^5$  solar mass BHs as 100% of DM [Green '16].

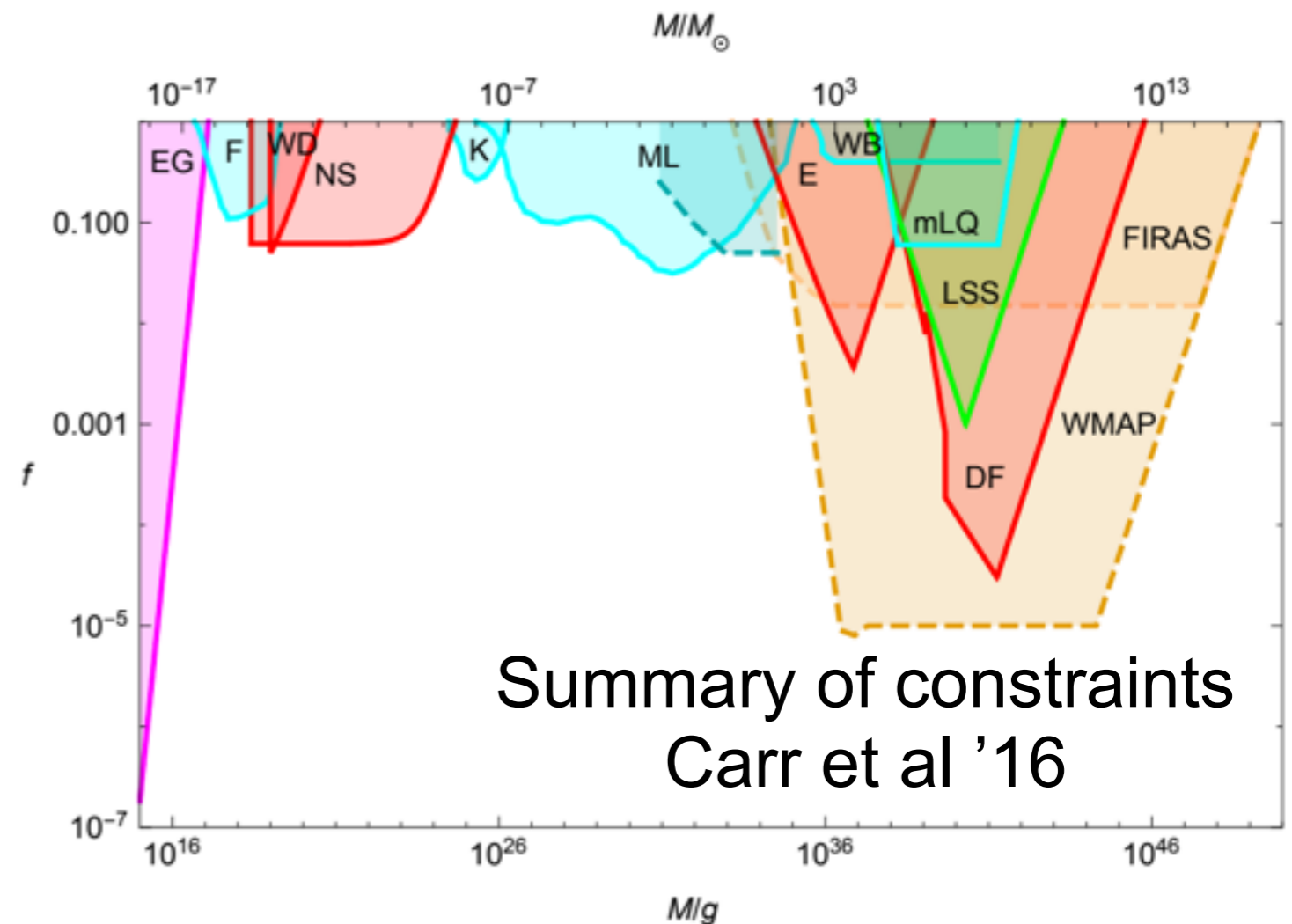

- It appears there is still an open window for primordial black holes to constitute 100% of the DM, around  $10^{-10}$ - $10^{-7}$  solar masses ( $\sim$ lunar mass scale).

# Summary

- We know dark matter is present in our universe, but it could inhabit any of an enormous range of mass scales, from  $\sim 10^{-21}$  eV bosons up to moon-mass primordial black holes.
- Searches have long focused on WIMP and axion scenarios, connected to hierarchy problem and strong CP problem respectively - now timely to consider theoretical frameworks for broader classes of DM scenarios.
  - In many classes of models (beyond simple thermal freezeout), DM-SM couplings are important in setting the relic density of DM - allows predictivity.
  - MeV-GeV mass window admits new thermal-relic target region - recent flourishing of models that naturally generate the required relic density while respecting current limits. Cosmological constraints put stringent requirements on thermal dark matter below the MeV scale.
- Now is a time of many exciting new DM-related ideas - including many I didn't mention, e.g. searching for neutron-star heating by DM-SM scattering [Baryakhtar et al '17] - I look forward to hearing about more of them over the next few days!

**BONUS SLIDES**

# Forbidden dark matter

d'Agnolo & Ruderman, Phys. Rev. Lett. 115, 061301 (2015)

- Dominant annihilation channel during freezeout is  $\text{DM DM} \rightarrow \gamma_D \gamma_D$ , where:  

$$m_{\text{DM}} < m_{\gamma_D} < m_{\text{DM}} + \text{KE}$$
- Requires DM on tail of the Boltzmann distribution: exponential suppression allows light DM with moderate-to-large couplings.
- At late times: forbidden channel is negligible, indirect signals dominated by direct annihilation to SM particles, controlled by small mixings.
- Requires a dark-sector particle with mass comparable to the DM, but slightly heavier.

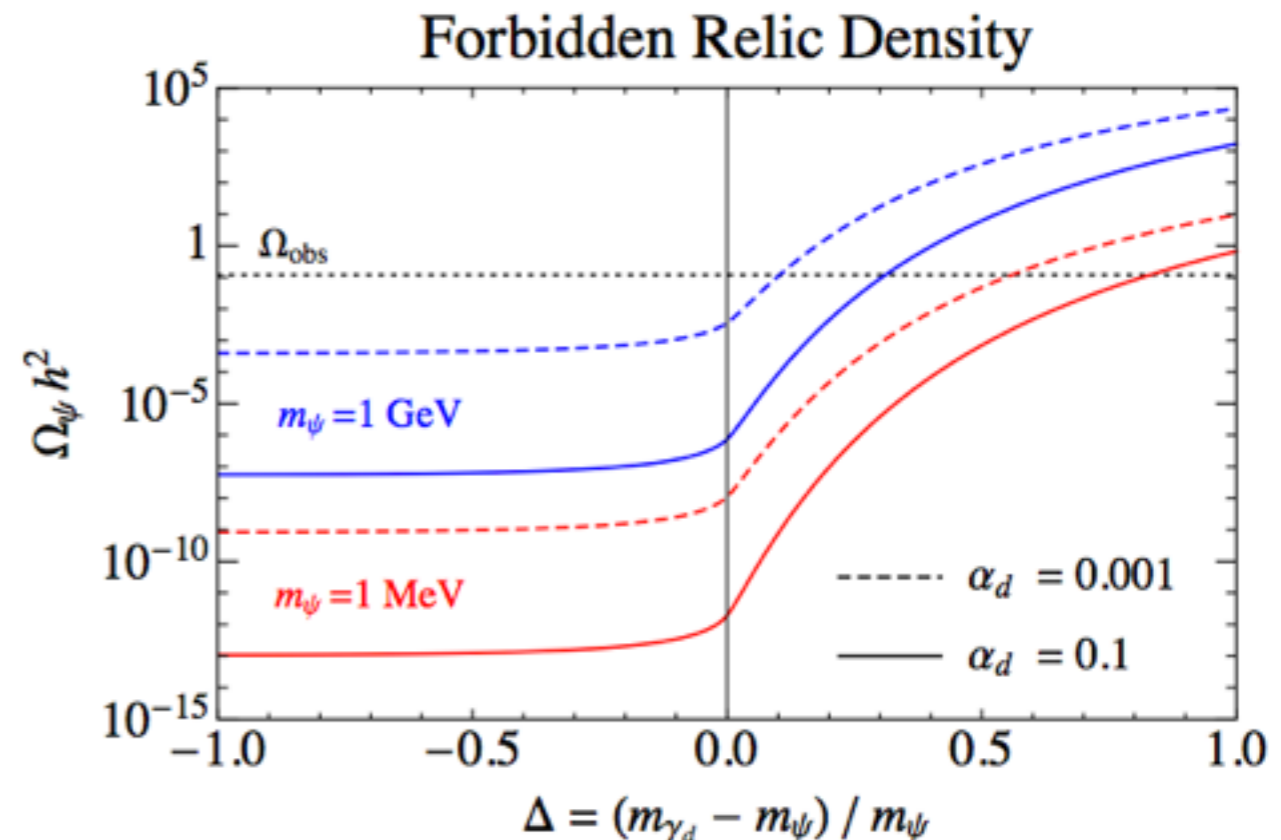
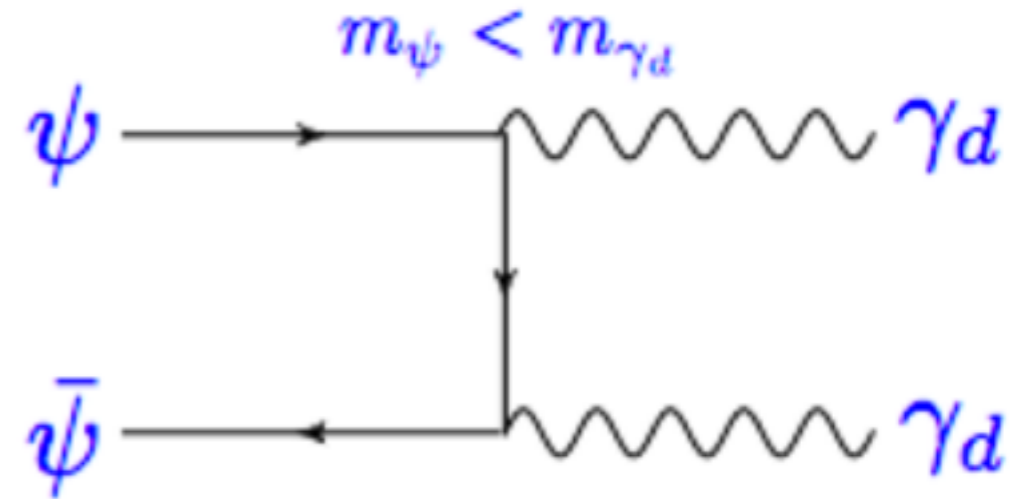



# Beyond forbidden channels

- However, as  $2 \rightarrow 2$  annihilations become increasingly suppressed, other channels can play key roles.
- Simple example: consider model where DM is a Dirac fermion charged under a dark  $U(1)$ .
- If the dark  $U(1)$  is broken such that the dark photon has mass satisfying:

$$2m_{\text{DM}} > m_{\gamma_D} > m_{\text{DM}}$$

- Then 3-body annihilations can dominate freezeout (also seen e.g. in SIMP models).

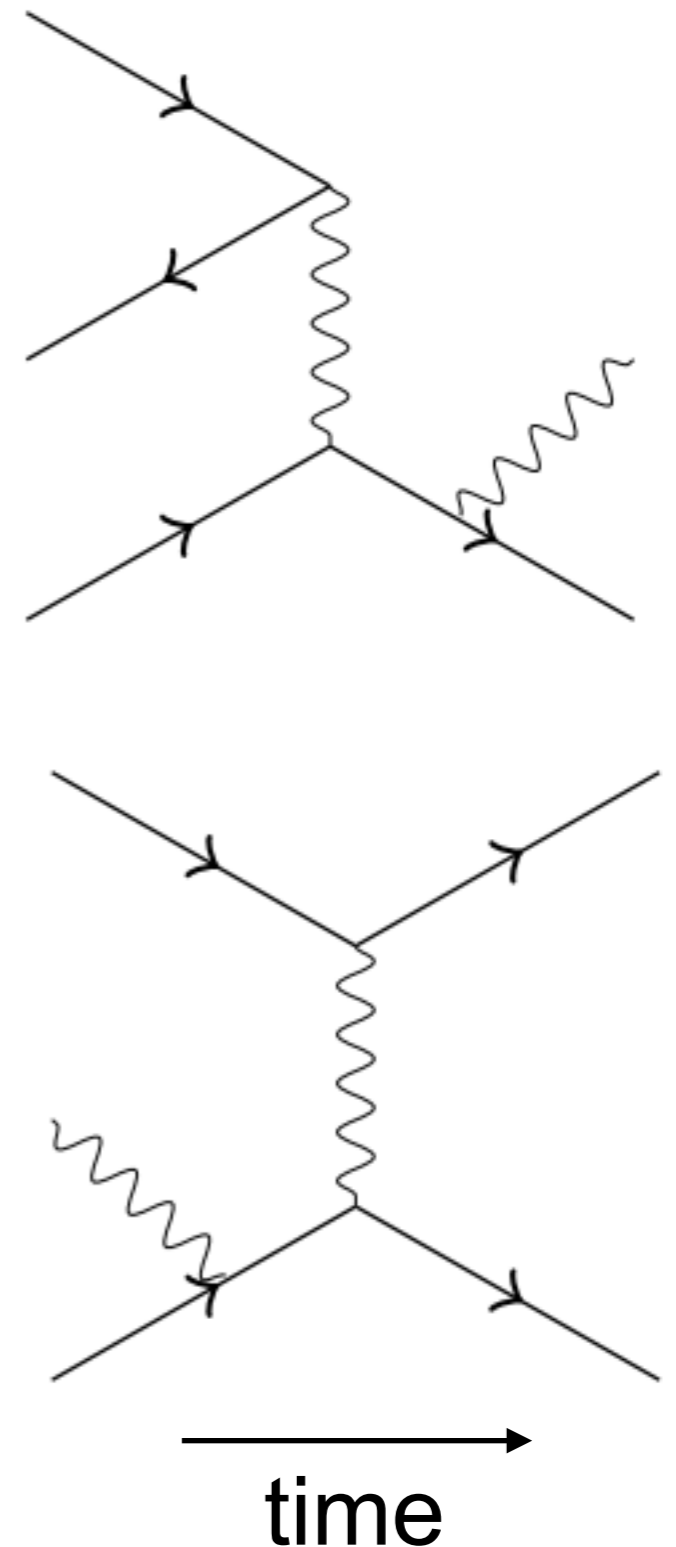

# ~~Forbidden~~ DM cosmology

- Need to solve coupled Boltzmann equations for DM and dark photon populations, including 2- and 3-body annihilation processes, and dark photon decays.

$$\frac{dn_\chi}{dt} + 3Hn_\chi = -\frac{1}{4}\langle\sigma v^2\rangle_{\chi\chi\bar{\chi}\rightarrow\chi A'} \left( n_\chi^3 - n_{\chi,0}^2 n_\chi \frac{n_{A'}}{n_{A',0}} \right) + \langle\sigma v\rangle_{A'A'\rightarrow\bar{\chi}\chi} \left( n_{A'}^2 - n_{A',0}^2 \frac{n_\chi^2}{n_{\chi,0}^2} \right)$$

$$\frac{dn_{A'}}{dt} + 3Hn_{A'} = \frac{1}{8}\langle\sigma v^2\rangle_{\chi\chi\bar{\chi}\rightarrow\chi A'} \left( n_\chi^3 - n_{\chi,0}^2 n_\chi \frac{n_{A'}}{n_{A',0}} \right) - \frac{1}{4} \left( \langle\sigma v^2\rangle_{\chi\bar{\chi}A'\rightarrow\chi\bar{\chi}} + \langle\sigma v^2\rangle_{\chi\chi A'\rightarrow\chi\chi} \right) (n_\chi^2 n_{A'} - n_\chi^2 n_{A',0})$$

$$- \langle\sigma v\rangle_{A'A'\rightarrow\bar{\chi}\chi} \left( n_{A'}^2 - n_{A',0}^2 \frac{n_\chi^2}{n_{\chi,0}^2} \right) - \Gamma_{A'\rightarrow f\bar{f}} (n_{A'} - n_{A',0})$$

- In general: two functions to solve for,  $n_\chi$  and  $n_{A'}$ . Two fastest processes dominate evolution equations: fastest process gives one constraint on  $n_\chi$  and  $n_{A'}$ , second-fastest maintains both  $n_\chi$  and  $n_{A'}$  at equilibrium values if it is faster than Hubble.
- Thus freezeout begins when second-fastest process rate becomes comparable to H; interplay between fastest and second-fastest processes controls freezeout.

# ~~Forbidden~~ DM cosmology

- Classic freezeout: decay of  $A'$  is fastest process, fast enough to keep  $n_{A'}$  in equilibrium. Freezeout of  $n_\chi$  set by second-fastest process, annihilation  $\chi\bar{\chi} \leftrightarrow A'A'$ .
- Not-forbidden DM: either decay +  $3 \rightarrow 2$  annihilation, or  $2 \rightarrow 2$  +  $3 \rightarrow 2$  annihilation, can also control freezeout - wide range of possible scenarios.
- When should  $3 \rightarrow 2$  annihilation dominate?

$n_{i,0} \sim \exp(-m_i/T)$ : in equilibrium

$$\Gamma_{\substack{\chi\chi\bar{\chi} \\ \rightarrow \chi A'}} \sim \langle \sigma v^2 \rangle_{\substack{\chi\chi\bar{\chi} \\ \rightarrow \chi A'}} n_{\chi,0}^2 \\ \sim \exp(-2m_\chi/T)$$

$$\Gamma_{\bar{\chi}\chi \rightarrow A'A'} \sim \langle \sigma v \rangle_{\bar{\chi}\chi \rightarrow A'A'} n_{\chi,0} \\ \sim \langle \sigma v \rangle_{A'A' \rightarrow \bar{\chi}\chi} n_{A',0}^2 / n_{\chi,0} \\ \sim \exp(-(2m_{A'} - m_\chi)/T)$$

$3 \rightarrow 2$  annihilation exponentially enhanced (suppressed) relative to  $2 \rightarrow 2$  for:

$$m_{A'} \gtrsim (\lesssim) \frac{3}{2} m_\chi \quad \text{Not-forbidden DM region}$$

# Freezeout

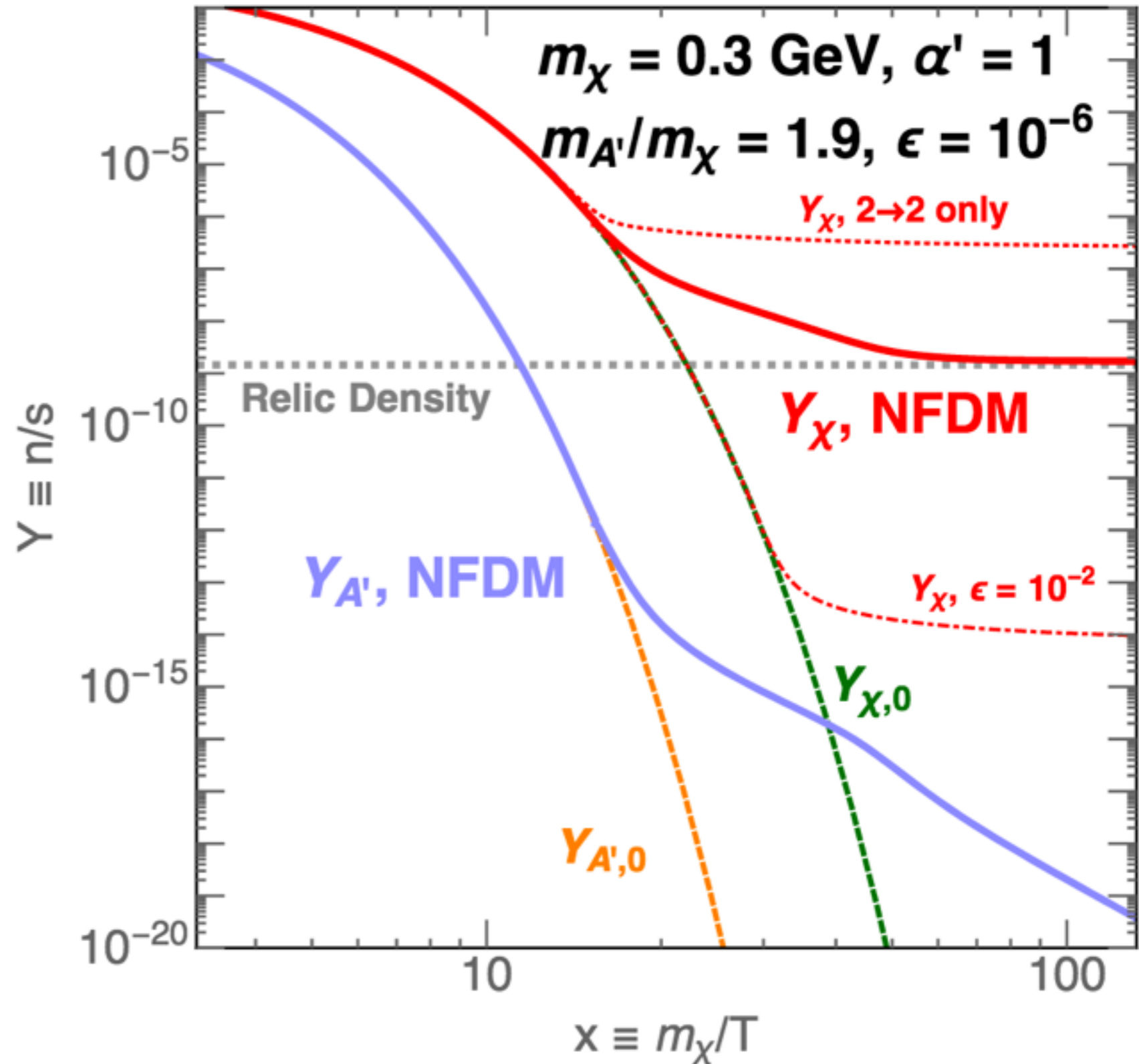
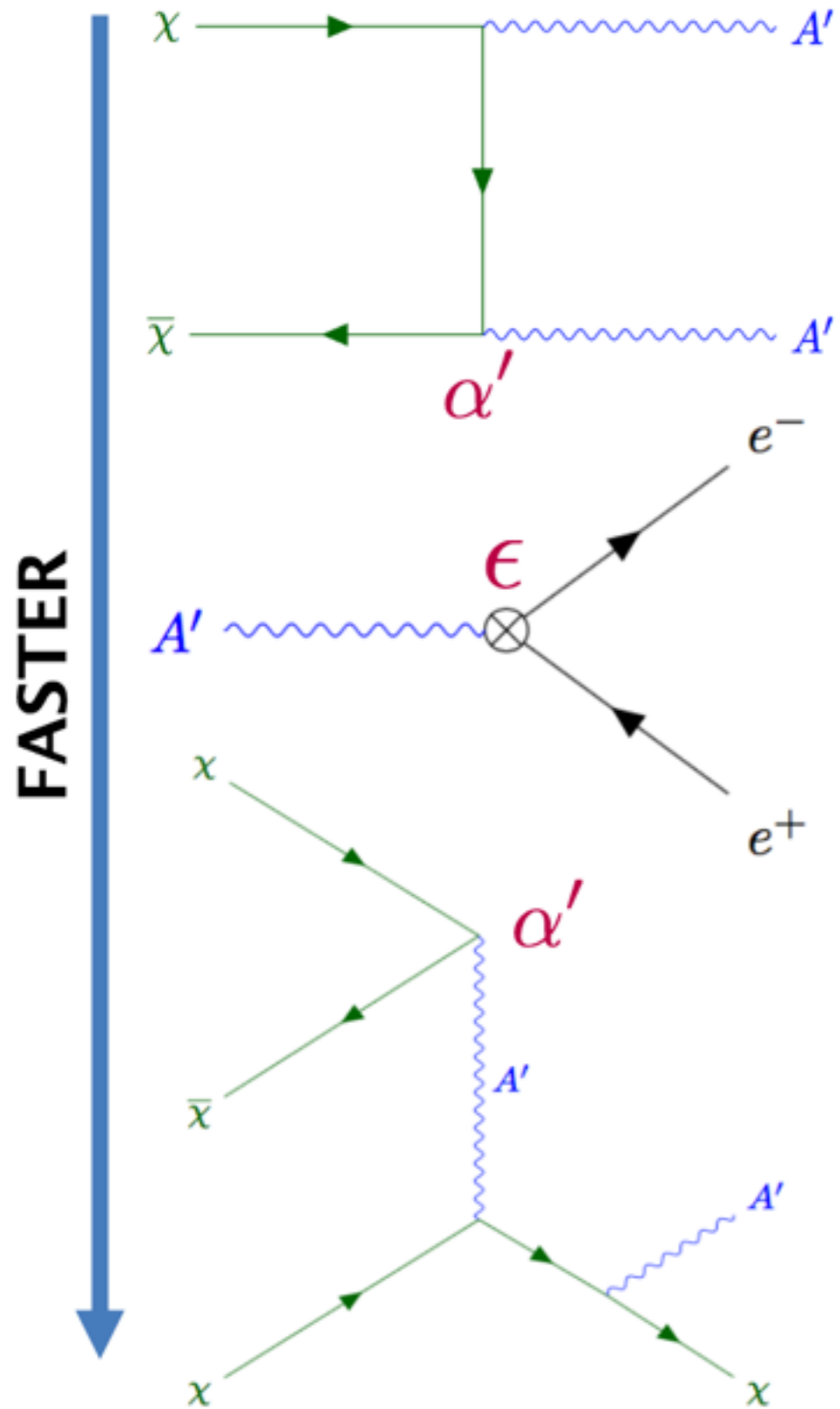

# Relic density

- Lower half of plot: “forbidden DM” region, forbidden  $2 \rightarrow 2$  process dominates, strong dependence on mass ratio  $r$ .
- Upper half of plot: NFDM region, kinematically allowed  $3 \rightarrow 2$  process dominates.
- Coupling needed to yield correct relic density no longer highly sensitive to  $m_{A'}$
- Similar to standard WIMP, but without requiring very small/large couplings for MeV-GeV DM.

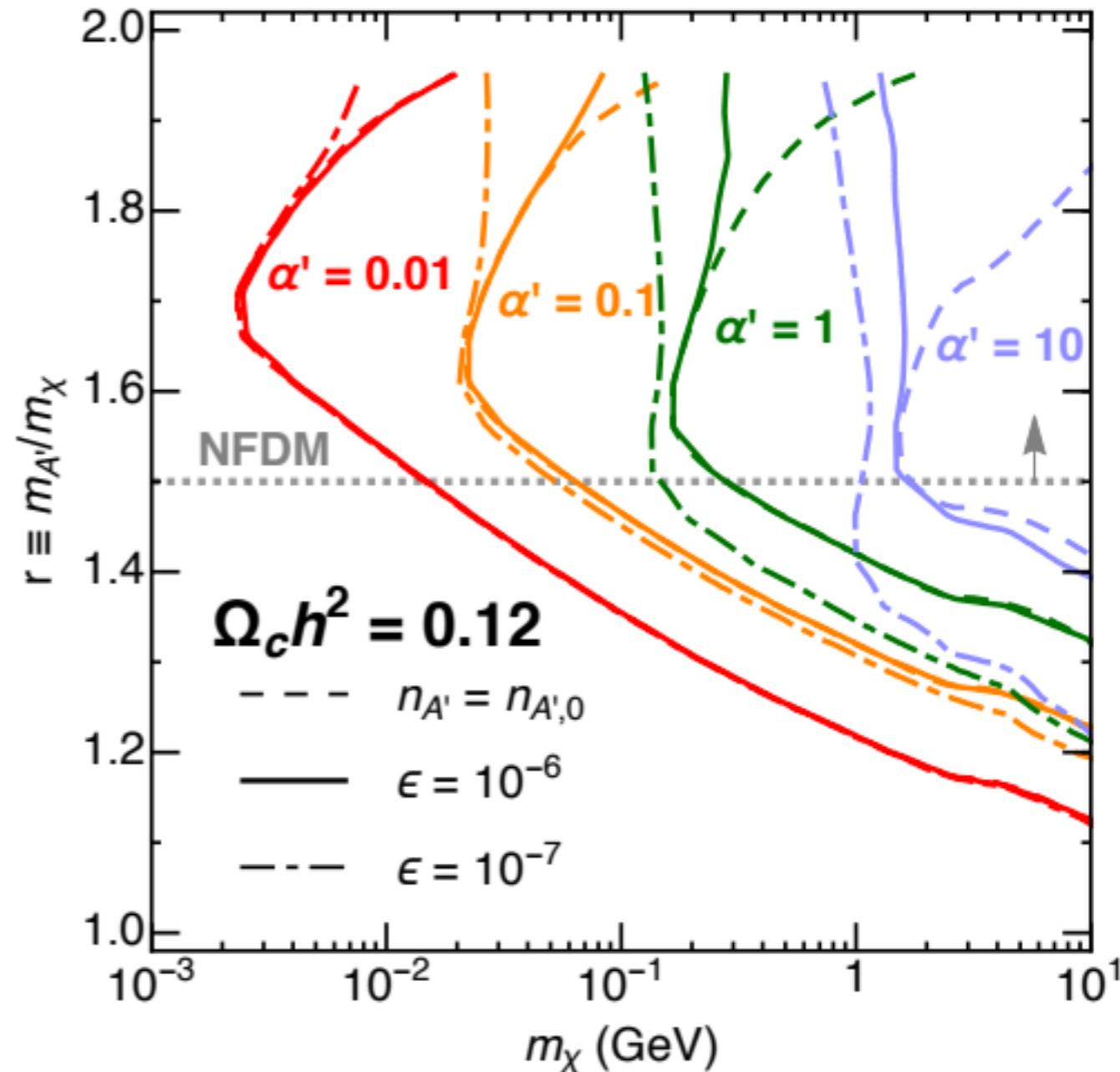

# Constraints on NFDM

- Coupling chosen to produce correct relic density.
- CMB limits on annihilation through s-channel  $A'$  to  $e^+e^-$  (3-body annihilation negligible due to low DM density).
- Beam dump, SN cooling limits bound dark photon directly.
- Allowed region naturally predicts self-interaction of correct size to explain small-scale structure issues.

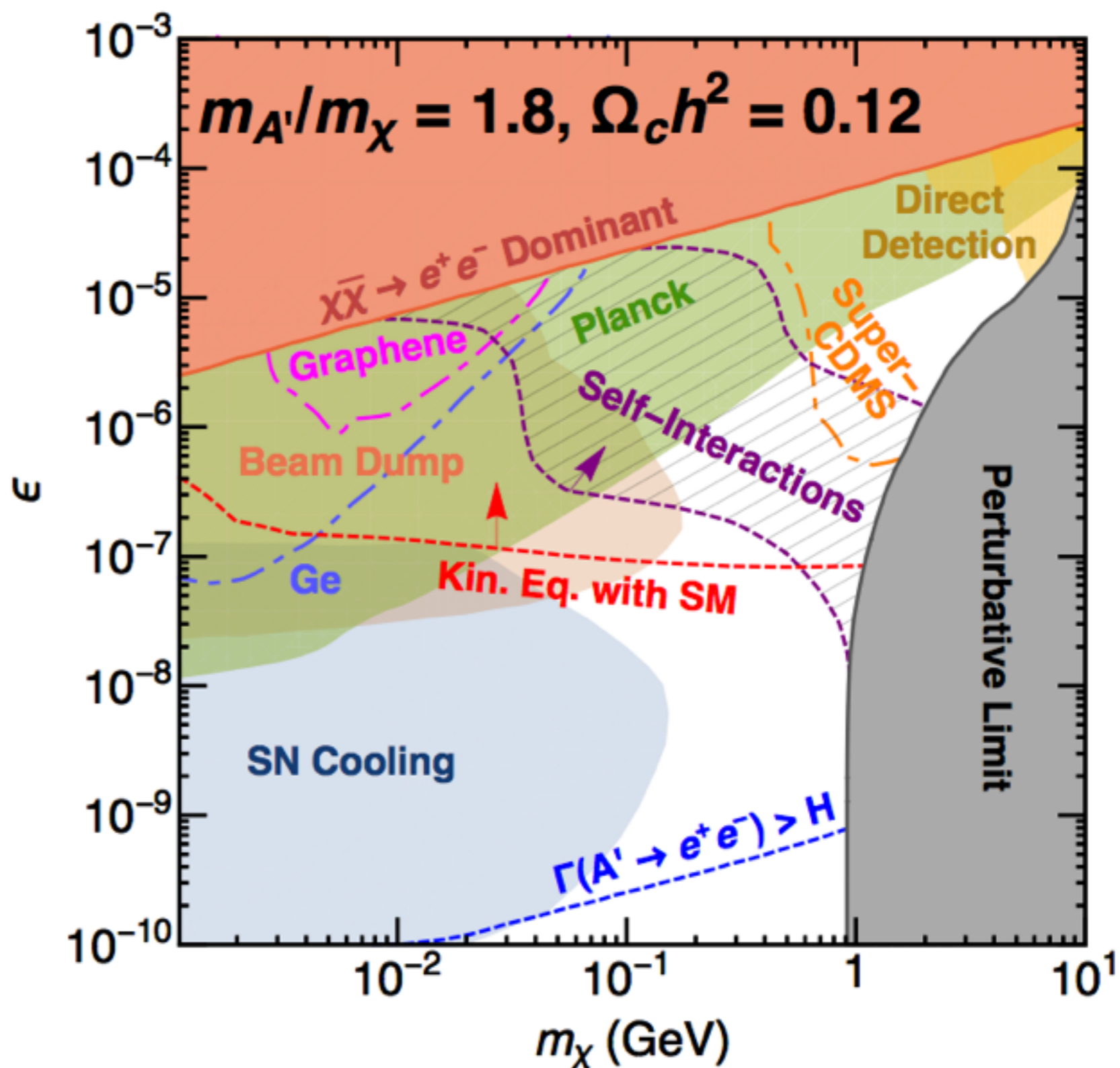

# Enabled DM for other values of $r$

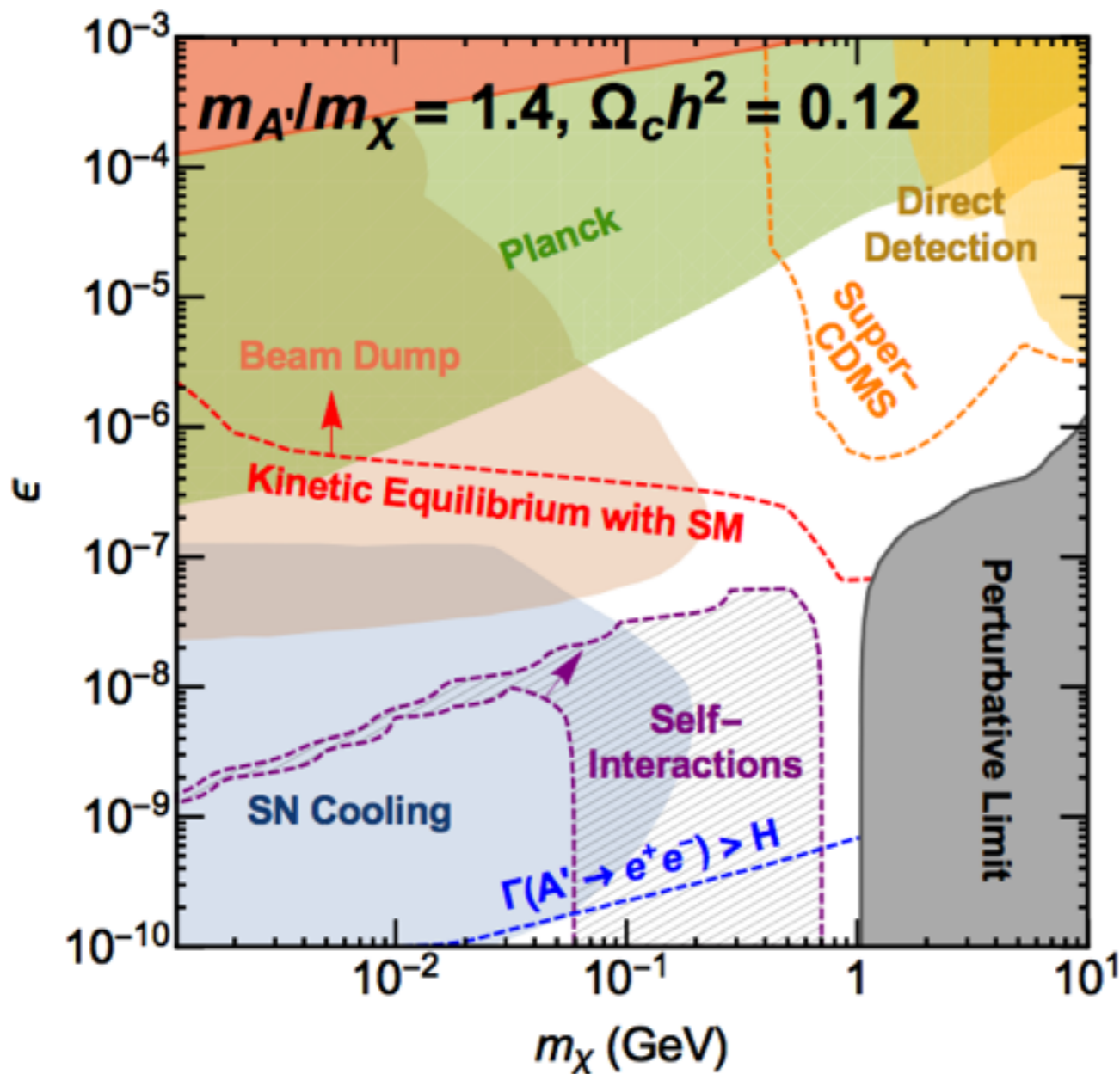

(a)

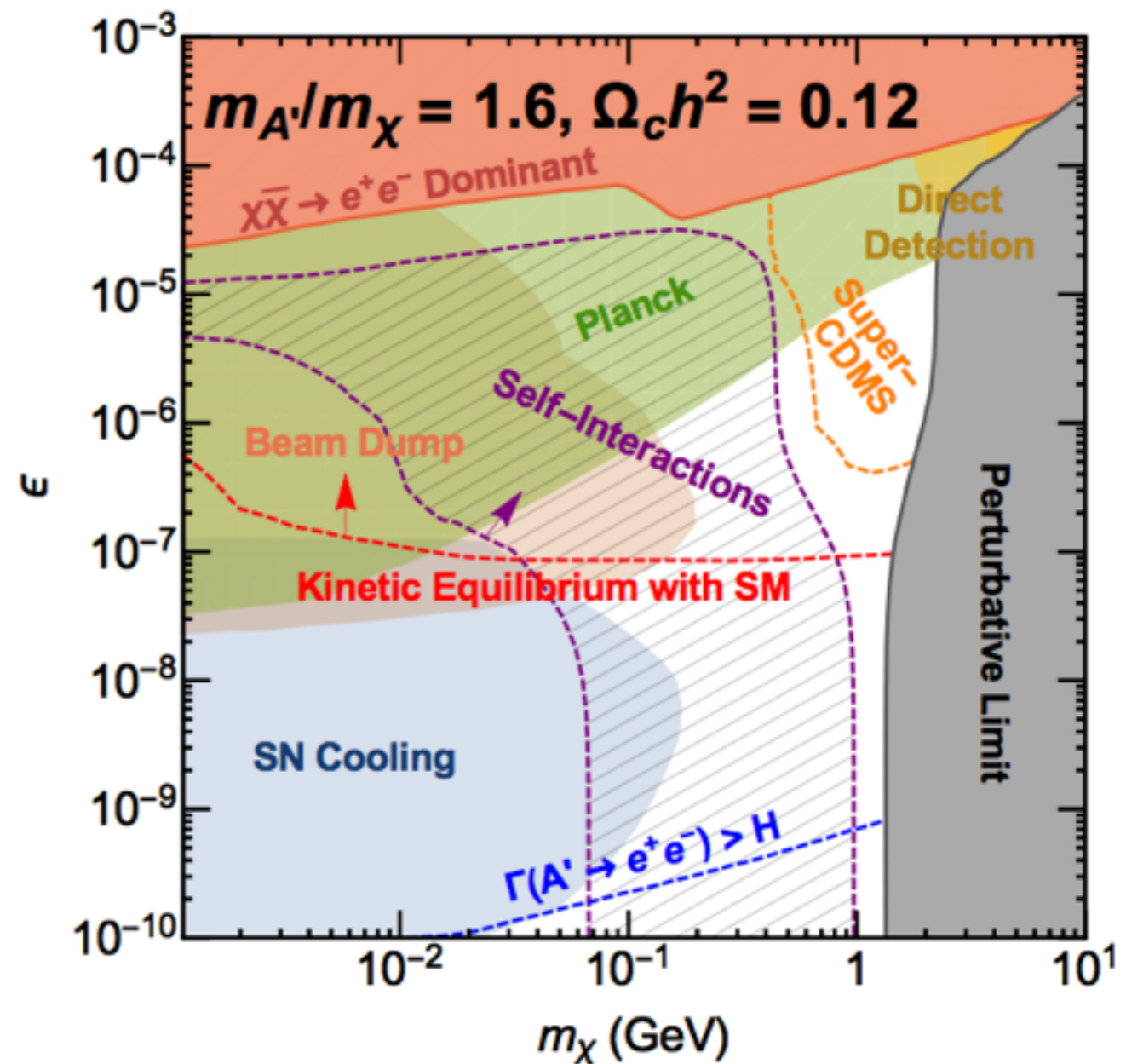

(b)

# Secluded enabled DM

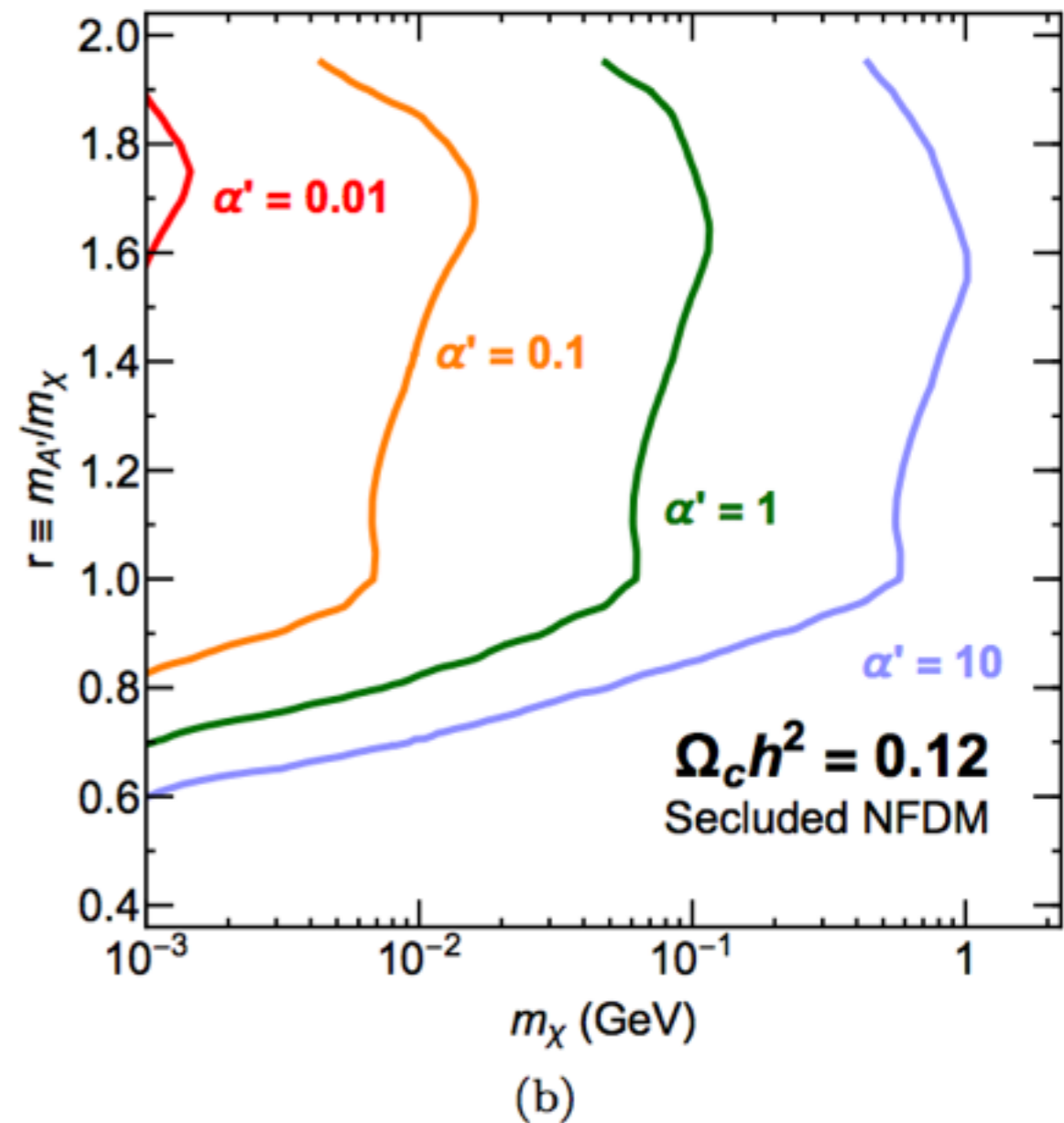
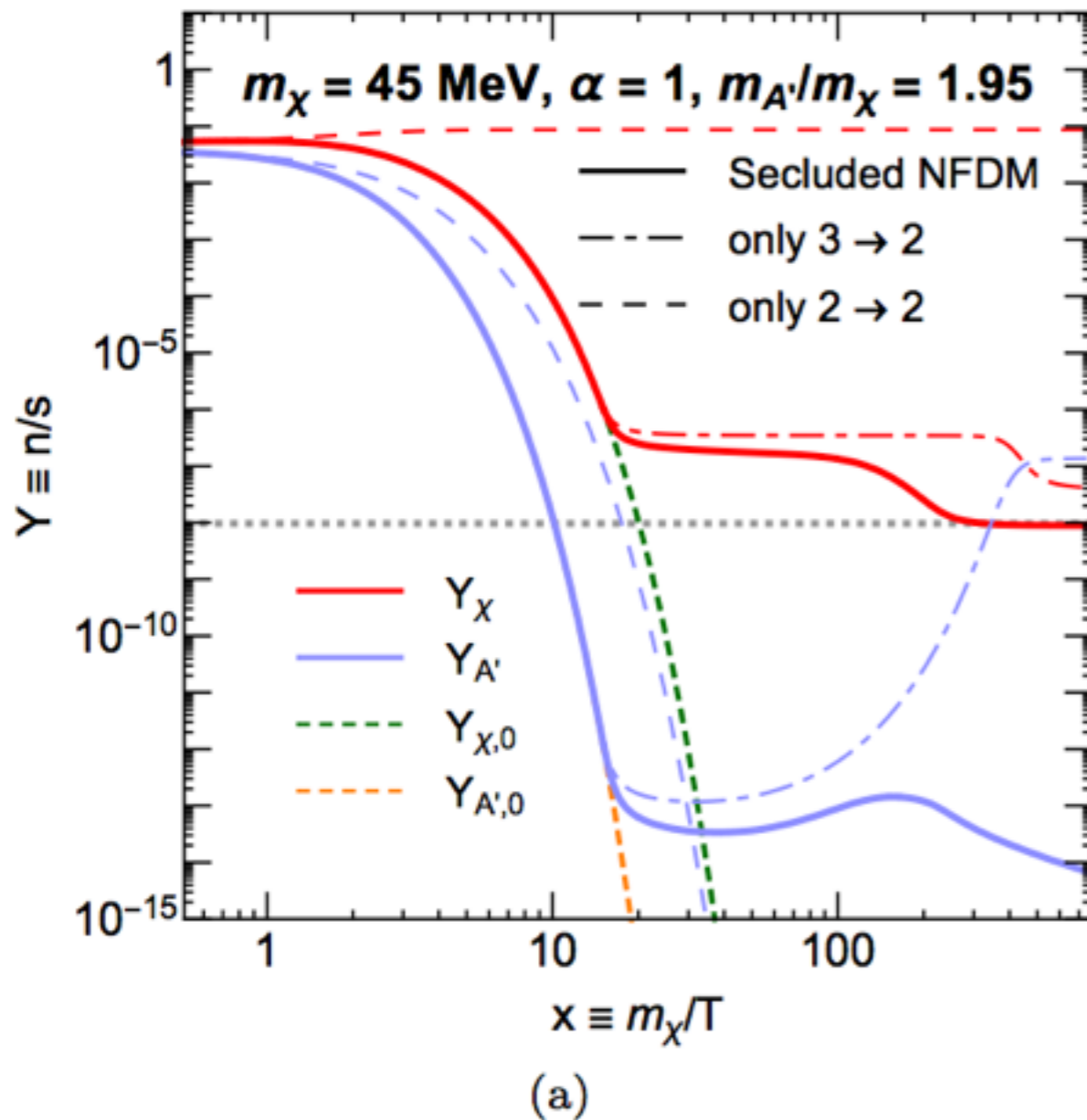

- Switch off decays of  $A'$ ; freezeout determined by interplay of  $3 \rightarrow 2$  and  $2 \rightarrow 2$  processes.
- Note: need to add more ingredients to dark sector in this case, to avoid an overly high DM temperature (as dark sector cannot dissipate entropy into the Standard Model).



# Impeded dark matter

- Similar to (not) forbidden DM, but mass splittings between DM and annihilation products (denoted  $X$ ) are much smaller - do not cause exponential suppression during freezeout.
- Define  $\Delta = m_{\text{DM}} - m_X$ .  $\Delta$  can be either positive or negative.
  - $\Delta$  negative: similar to forbidden case. Annihilation exponentially suppressed below a characteristic velocity scale. For small  $\Delta$ , this scale is usually far below freezeout, but can be relevant for indirect detection.
  - $\Delta$  positive: annihilation never forbidden, but phase space suppresses rate.

# Phase space suppression

- For s-wave processes, matrix element for scattering/annihilation is momentum-independent.
- Consequently, cross section for any  $2 \rightarrow 2$  process scales as (COM frame):  $\sigma \propto \frac{1}{s} \frac{|\vec{p}_{\text{out}}|}{|\vec{p}_{\text{in}}|}$
- For non-relativistic DM, approximate  $s = (2 m_{\text{DM}})^2$ , initial momentum  $m_{\text{DM}} v_{\text{rel}}/2$ , so we have:  
 $\sigma v_{\text{rel}} \propto |\vec{p}_{\text{out}}|$
- For typical DM annihilation to much lighter species,  $p_{\text{out}} \sim m_{\text{DM}}$ , so  $\sigma v_{\text{rel}}$  is momentum-independent.
- For DM-DM scattering,  $p_{\text{out}} \sim m_{\text{DM}} v_{\text{rel}}$ , so  $\sigma$  is momentum-independent.
- For DM-DM annihilation to  $XX$ , with mass  $m_X$ :

$$\begin{aligned}
 p_{\text{out}} &= \sqrt{E_{\text{DM}}^2 - m_X^2} && \text{assuming non-relativistic DM} \\
 &\approx \sqrt{\left(m_{\text{DM}} + \frac{1}{2} m_{\text{DM}} v_{\text{rel}}^2/4 + m_X\right) \left(m_{\text{DM}} + \frac{1}{2} m_{\text{DM}} v_{\text{rel}}^2/4 - m_X\right)} \\
 &\approx 2m_{\text{DM}} \sqrt{\frac{2\Delta}{m_{\text{DM}}} + \frac{1}{4} v_{\text{rel}}^2} && \text{approximating } \Delta = m_{\text{DM}} - m_X \ll m_{\text{DM}}
 \end{aligned}$$

# Impeded dark matter

- For  $1 \gg v_{\text{rel}}^2 \gg 8 |\Delta| / m_{\text{DM}}$ , behavior is the same independent of sign of  $\Delta$ ;  $\sigma v_{\text{rel}}$  scales as  $v_{\text{rel}}$ , similar to scattering rather than s-wave annihilation.
- More mild velocity suppression than p-wave annihilation ( $\sigma v_{\text{rel}} \propto v_{\text{rel}}^2$ ), but similar qualitative impact: suppresses indirect signals in objects/regions/epochs with small velocity dispersions, e.g. the epoch of recombination (no bound DM structures  $\Rightarrow$  very small velocity dispersion) or dwarf galaxies.
- For  $v_{\text{rel}}^2 < 8 |\Delta| / m_{\text{DM}}$ , behavior depends on sign of  $\Delta$ ; for  $\Delta$  negative, the annihilation becomes kinematically forbidden, for  $\Delta$  positive,  $\sigma v_{\text{rel}}$  becomes constant but with a phase-space suppression factor of order  $(\Delta/m_{\text{DM}})^{1/2}$ .

# Example models

- Adapt examples of states with similar mass from Standard Model
  - Gauge bosons with masses connected by residual symmetry after breaking
  - Charged and neutral pions

Model	$SU(2)_d$ dark gauge boson		dark pion
	$\Delta \simeq -\frac{1}{2}\epsilon^2 m_{\text{DM}}, \quad \text{eq. (10)}$		$\Delta \simeq g'^2 f_\pi^2 / (2m_\pi), \quad \text{eq. (28)}$
mass splitting	$10^{-7} \lesssim \epsilon \lesssim 10^{-3}$ $\Delta < 0$ small	$\epsilon \gtrsim 10^{-3}$ $\Delta < 0$ large	$g' \gtrsim 0.05$ $\Delta > 0$
freeze-out	$\sigma v_{\text{rel}} \propto v_{\text{rel}}$		
CMB	$\sigma v_{\text{rel}} \simeq 0$	$\sigma v_{\text{rel}} \simeq 0$	$\sigma v_{\text{rel}} \propto \sqrt{\frac{2\Delta}{m_{\text{DM}}}}$
Galaxies	$\sigma v_{\text{rel}} \propto v_{\text{rel}}$		
Clusters			

# Example model: $\Delta < 0$

- Dark sector consists of a dark SU(2) + dark scalar doublet  $\Phi$  to break symmetry.

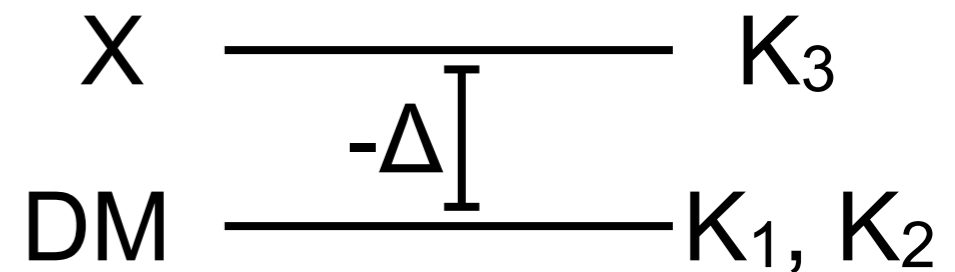

- DM is lightest SU(2) gauge boson(s); undergoes impeded annihilation to heavier SU(2) gauge bosons.

- Dark SU(2) coupled to SM through dimension-6 non-Abelian kinetic mixing term:

$$\mathcal{L}_{\text{mix}} = \frac{1}{\Lambda^2} (\Phi^\dagger T^a \Phi) K_{\mu\nu}^a B_{\mu\nu}$$

- After SU(2) breaking, only  $K_3^\mu$  (denoting gauge bosons by  $K_a^\mu$ ) mixes with SM Z and photon fields - induces a mass splitting between  $K_3^\mu$  (functions as unstable X) and  $K_1^\mu, K_2^\mu$  (constitute the DM).

$$\Delta \equiv m_k - m_{K_3} \simeq -\frac{m_k}{2} \frac{\varepsilon^2}{\cos^2 \theta_w} \frac{(m_k^2 - \cos^2 \theta_w m_{Z,\text{SM}}^2)}{m_k^2 - m_{Z,\text{SM}}^2} \quad \varepsilon \equiv -v_d^2 \cos \theta_w / (2\Lambda^2)$$

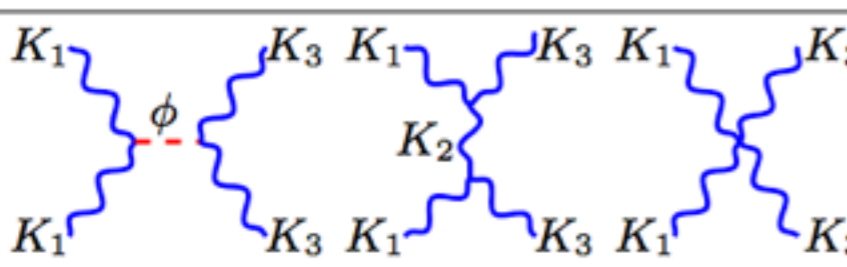
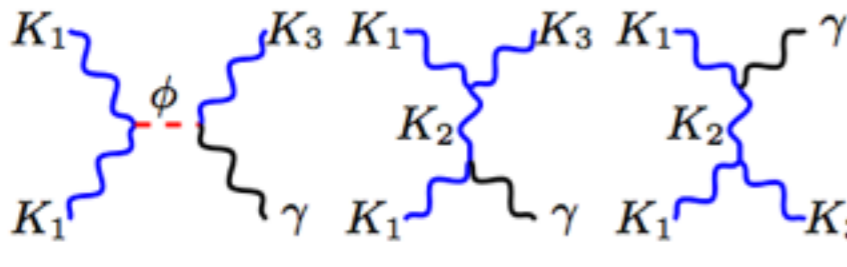
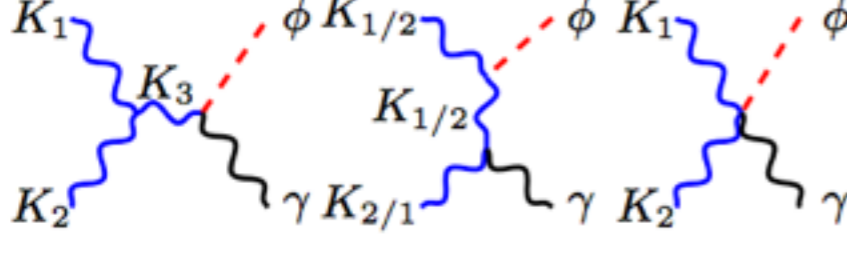
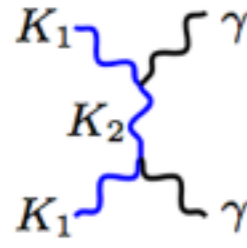
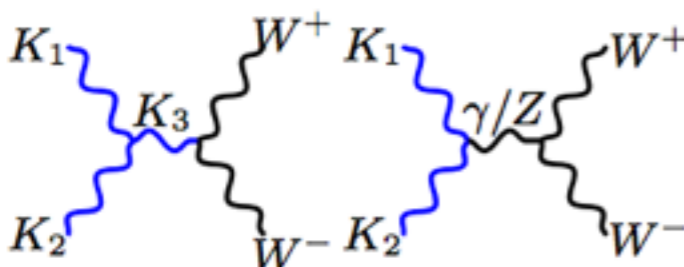
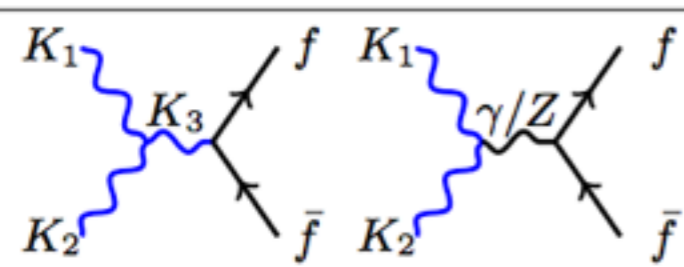
process	$v_{\text{rel}}$ -dependence	$\epsilon$ -dependence	freeze-out	CMB	Indirect Detection
	$\sqrt{\frac{v_{\text{rel}}^2}{4} + \frac{2\Delta}{m_{\text{DM}}}}$	1	dominant	negligible	✓
	1	$\epsilon^2$	subdominant	dominant	✓ ( $\gamma$ line)
	1	$\epsilon^2$	subdominant (requires $m_\phi < 2m_k$ )	dominant (requires $m_\phi < 2m_k$ )	✓ ( $\gamma$ line if $m_\phi < 2m_k$ )
	1	$\epsilon^4$	negligible	negligible	negligible
	$v_{\text{rel}}^2$	$\epsilon^2$	subdominant	negligible	negligible
	$v_{\text{rel}}^2$	$\epsilon^2$	subdominant	negligible	negligible

# Constraints on dark SU(2)

## $\Delta < 0$ model

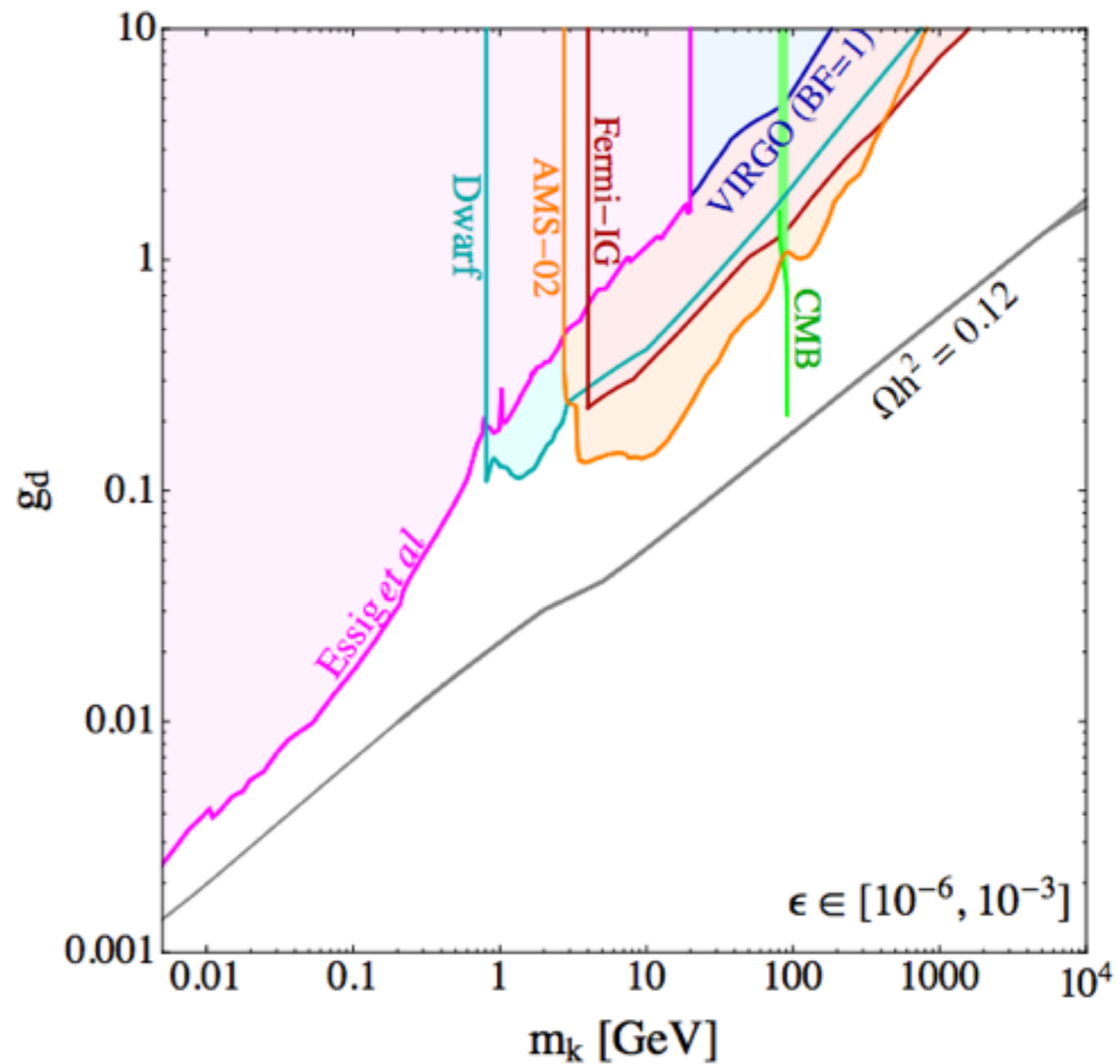
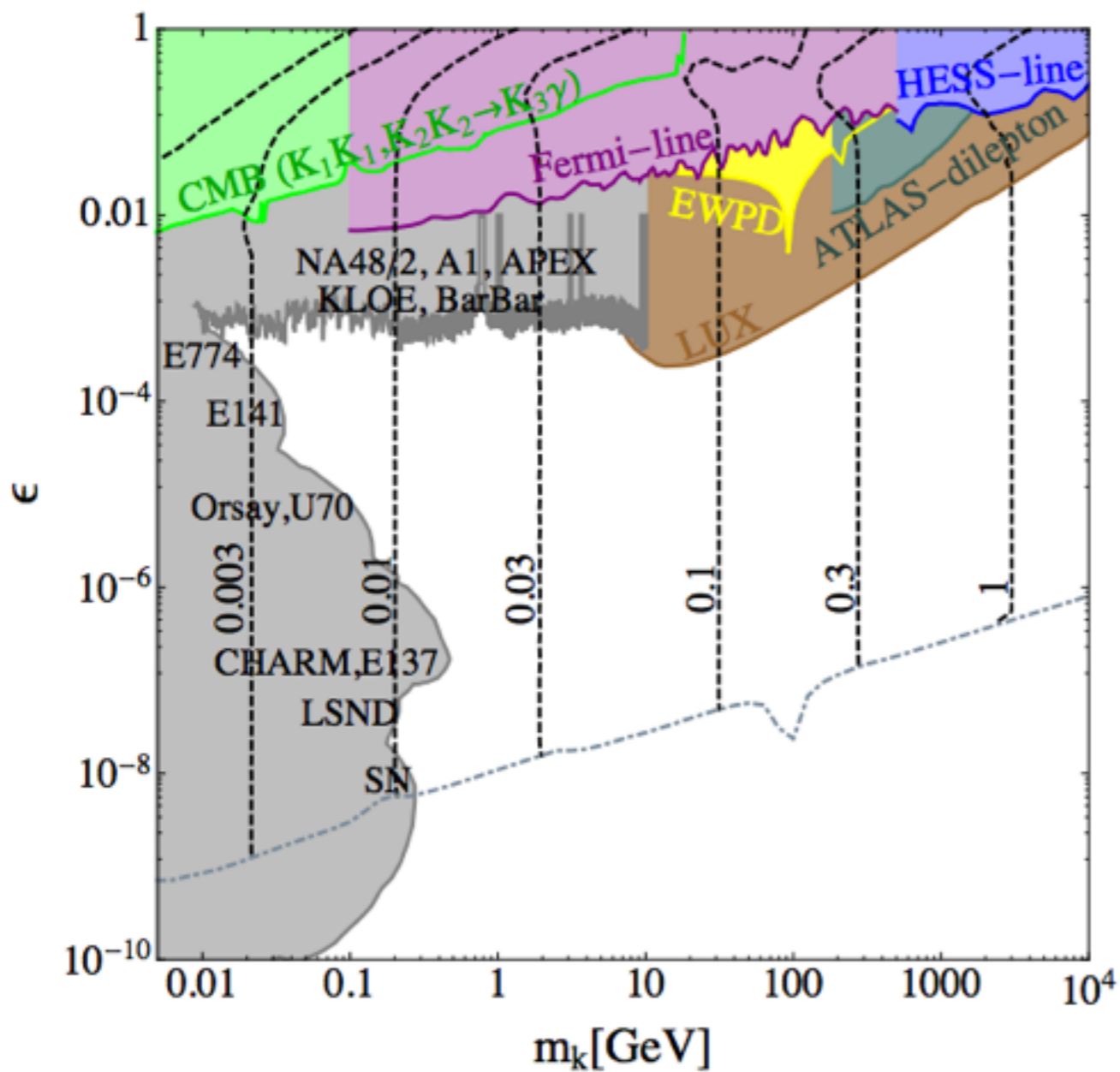

# Example model: $\Delta > 0$

- Dark sector has a  $SU(N) \times U(1)$  gauge symmetry, based on SM strong+electromagnetic interactions. Contains two light “dark quarks”, and a dark scalar field with  $U(1)$ -charge 2, which breaks the dark  $U(1)$  symmetry.

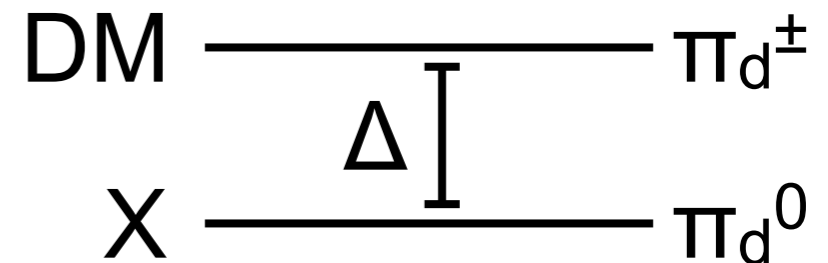

- Dark matter = dark “charged pions”, stabilized by residual  $Z_2$  symmetry after  $U(1)$  breaking.
- Freezeout dominated by impeded annihilation of DM to neutral pions.

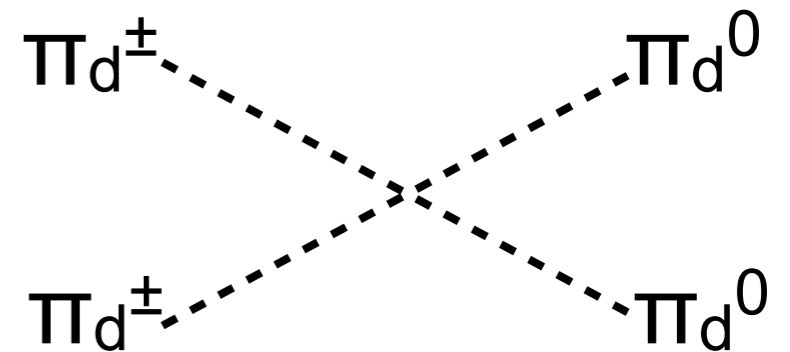

- Dark “neutral pion” decays to dark photons (through chiral anomaly), in analogy to SM.

- Dark photons kinetically mix with SM photon.

set by relic density

- Radiative mass splitting:  $\Delta \equiv m_{\pi_d^\pm} - m_{\pi_d^0} \approx \frac{g'^2}{16\pi^2} \frac{\Lambda_N^2}{2m_\pi}$   $\Lambda_N = 4\pi f_\pi$





# Field content for dark pion model

	SU(N)	$U(1)'$
$u_d$	$\square$	$2/3$
$d_d$	$\square$	$-1/3$
$\phi$	1	2

Table II. Field content and quantum numbers of the dark pion model, where  $\square$  stands for the fundamental representation of the dark  $SU(N)$ . We show here only the field content necessary for the Impeded DM phenomenology, but it is important to keep in mind that additional particles like heavy dark leptons are necessary for **anomaly** cancellation.

# Constraints on the dark pion model

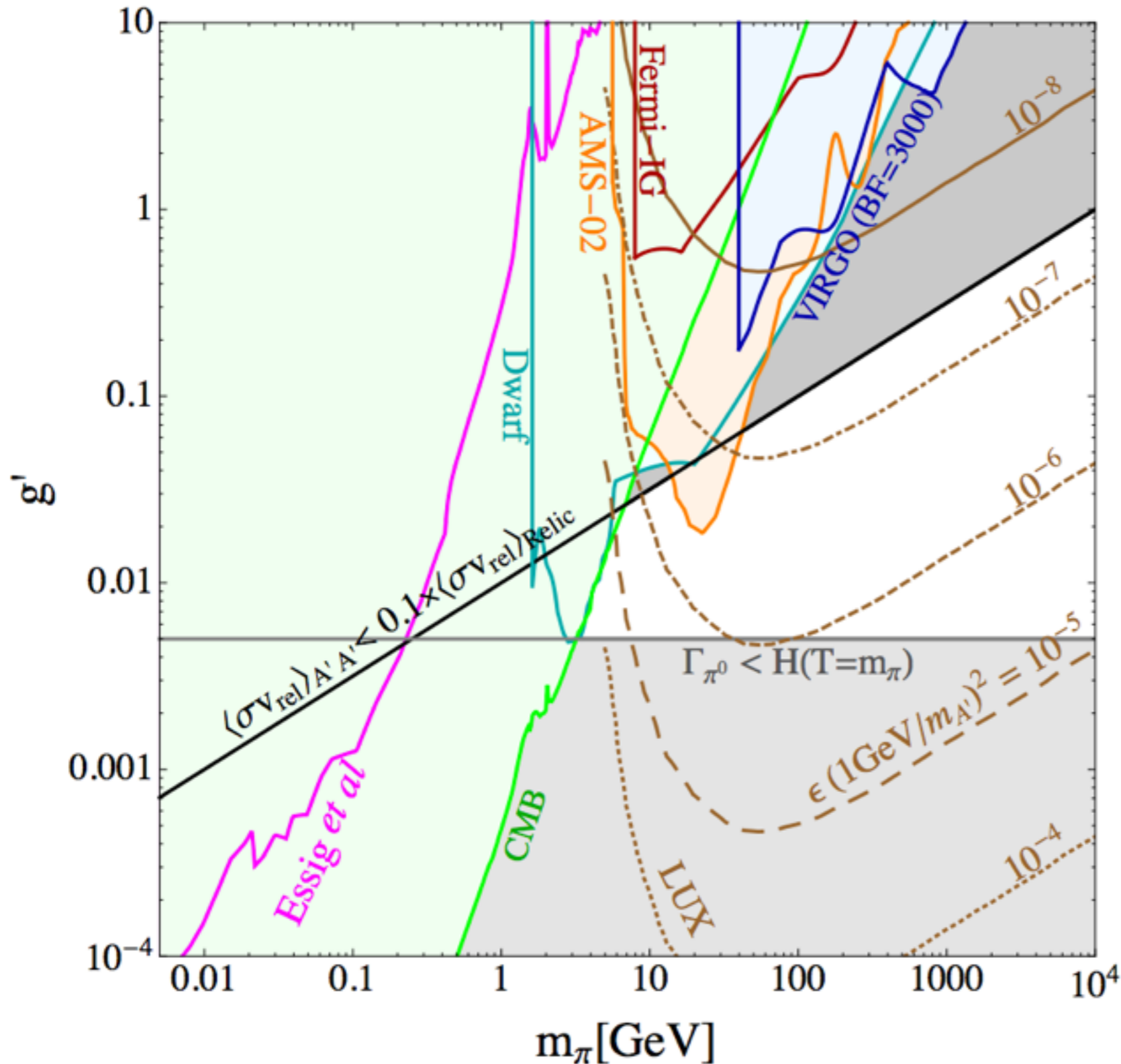

Ahnen et al '16

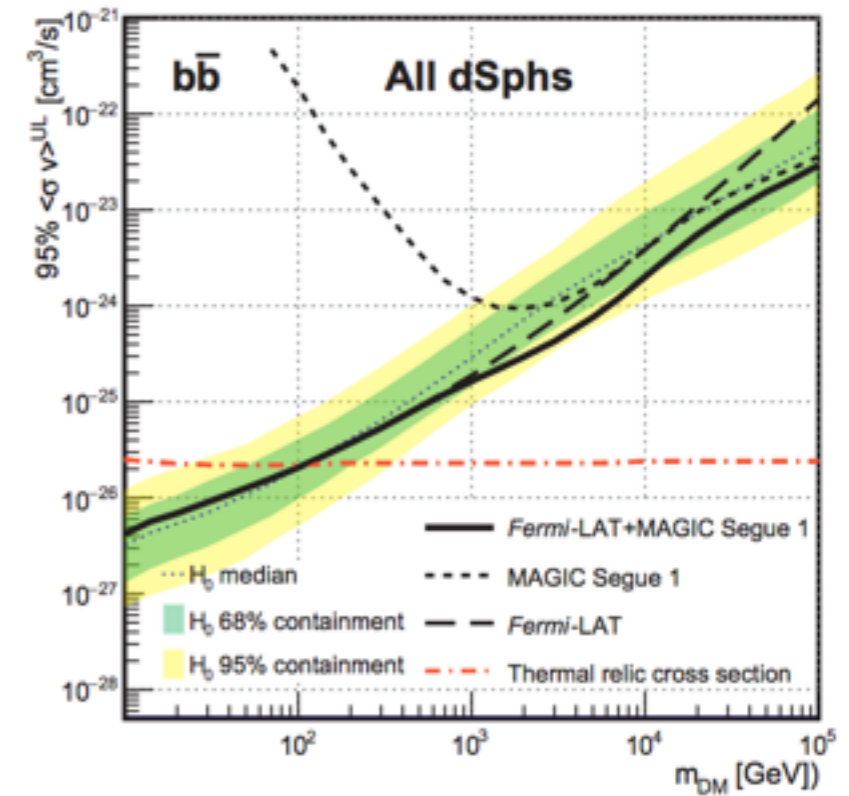

Planck Collaboration 2015

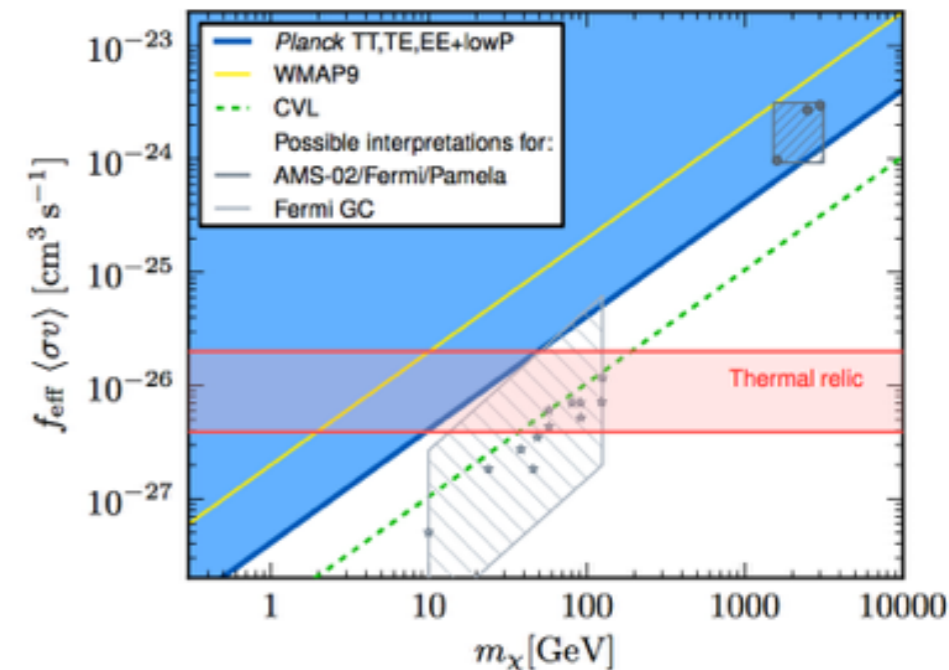

# The low-mass thermal region

- Suppose we continue to focus on thermal freezeout, but consider the sub-GeV mass range.
- Approach:
  - consider simplified models of scalar/Majorana fermion/pseudo-Dirac fermion DM,
  - fix coupling to annihilation products via thermal relic calculation,
    - if DM directly coupled to Standard Model, explore implications of thermal coupling,
    - if DM annihilates within dark sector, search for mediators between dark and visible sectors, invisible decays, etc.
  - re-examine complementarity between direct/indirect/accelerator searches.

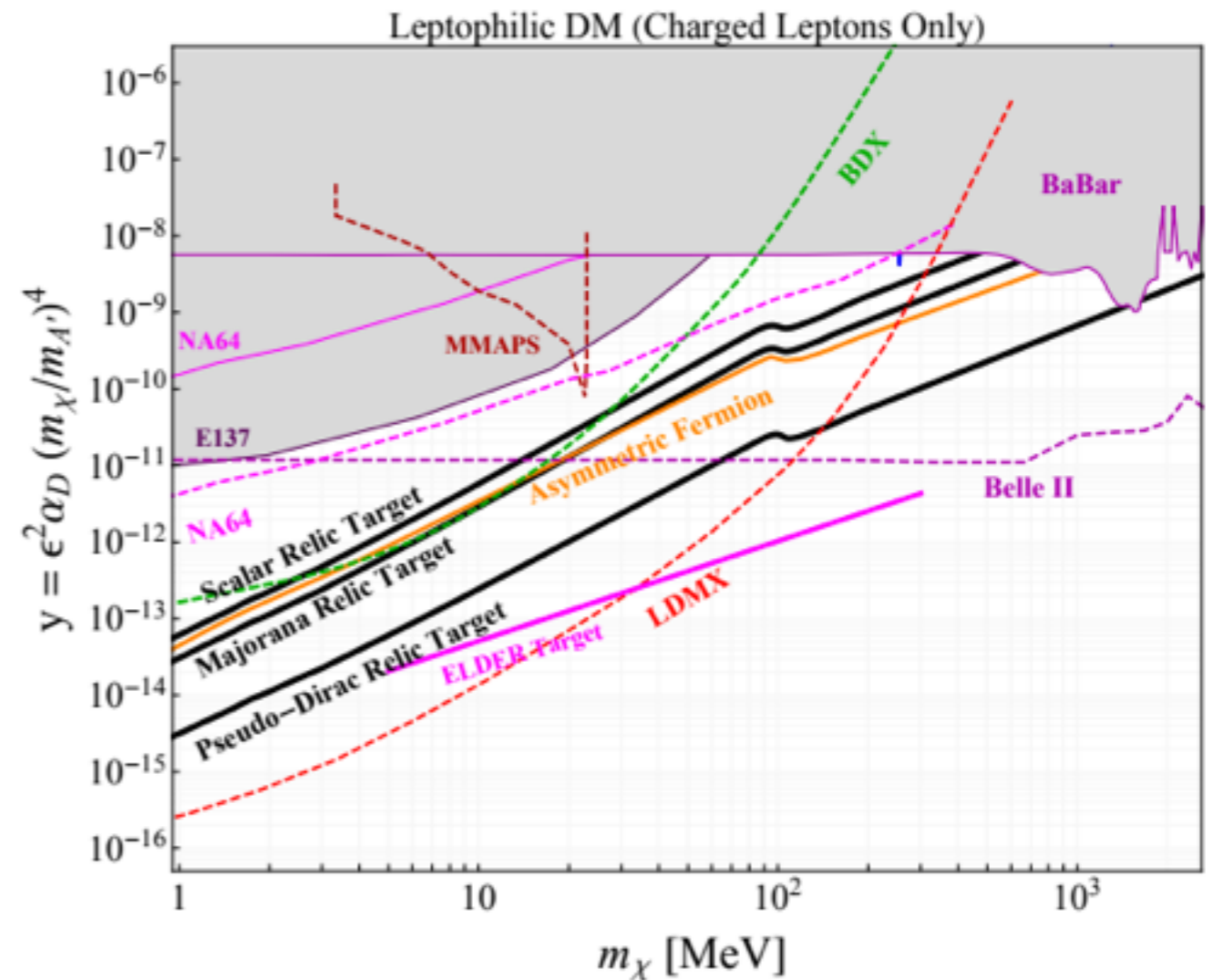

Example for thermal relic DM annihilating through a leptophilic mediator  
Battaglieri et al '17, Cosmic Visions report