



LUNA

Laboratory for Underground
Nuclear Astrophysics



Istituto Nazionale di Fisica Nucleare

The LUNA-MV facility at Gran Sasso

Paolo Prati
Univ. of Genoa and INFN
LUNA Spokesperson

XV International Conference on
Topics in
**Astroparticle and
Underground Physics**



24 - 28 July 2017
Sudbury, ON, Canada





Nuclear astrophysics

LUNN
Laboratory for Underground
Nuclear Astrophysics

- Aim of nuclear astrophysics: understand nuclear reactions that shape much of the visible universe
- Nuclear fusion is the engine of stars: it produces the energy that stabilizes them against gravitational collapse and makes them shine
- Among the key parameters (chemical composition, opacity, etc.) to model stars, reactions cross sections play an important role
- The evolution of the stars is determined by fusion reactions
- They determine the origin of elements in the cosmos, stellar evolution and dynamic
- Many reactions ask for high precision data

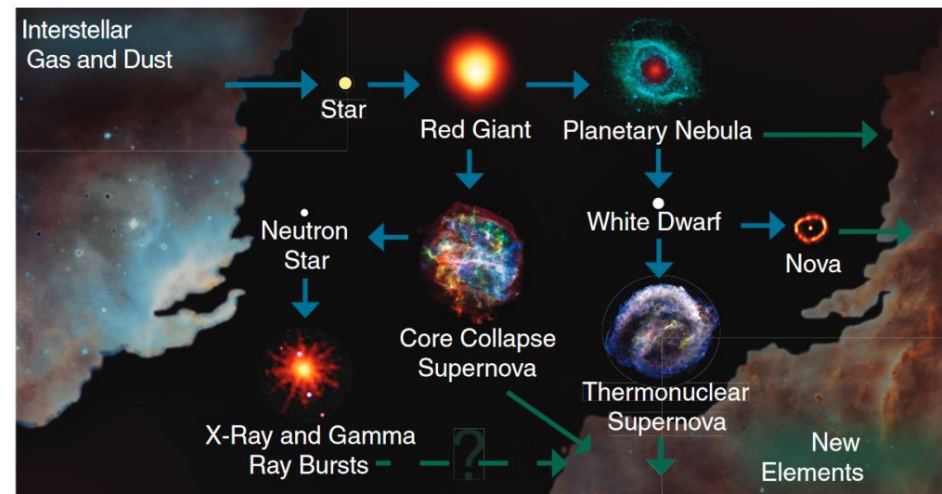
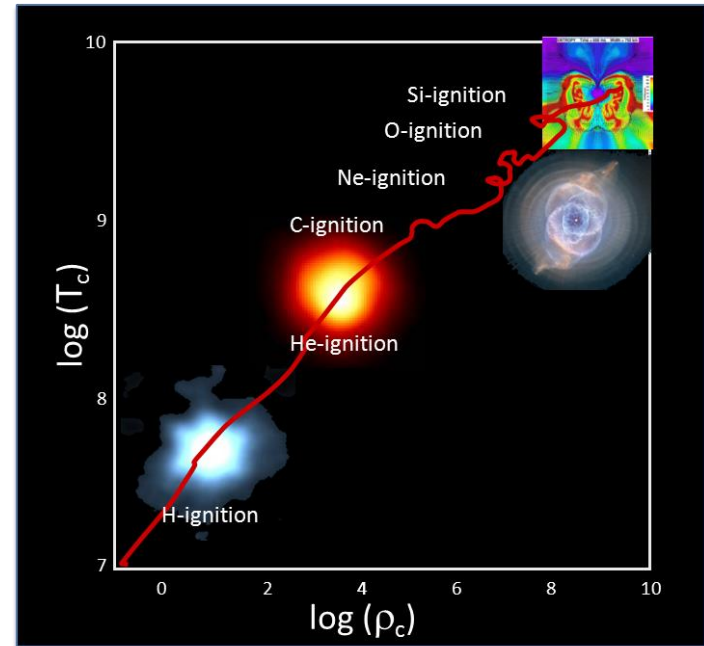

"Some people are so crazy that they actually venture into deep mines to observe the stars in the sky"

De origine animalium - Aristotele



Nuclei in the Cosmos I / **1990** / Baden/Vienna, Austria

Why are we not going into the Gran Sasso?



Gianni Fiorentini

Claus Rolfs

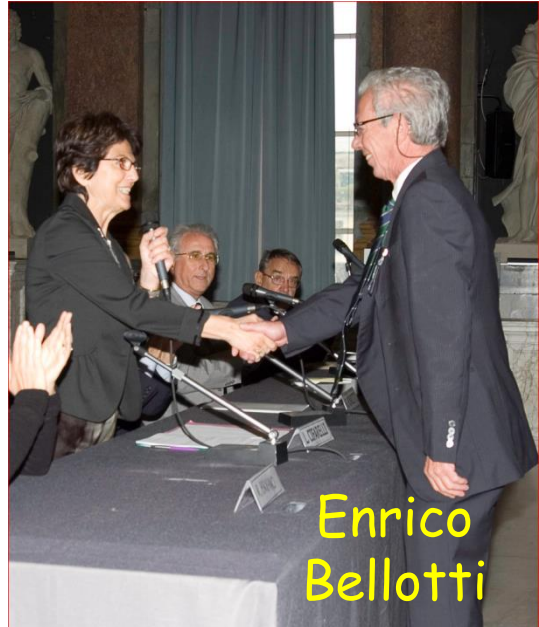

Enrico Bellotti

Laboratory for **U**nderground **N**uclear **A**strophysics



LUNA MV
(2015->...)

LUNA 1
(1991-2001) ●
50 kV

LUNA 2 ●
(2000->...)
400 kV

LNGS (1400 m rock shielding \equiv 4000 m w.e.)

Hydrogen burning at LUNA

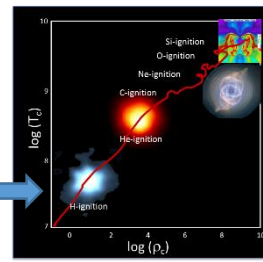

pp chain

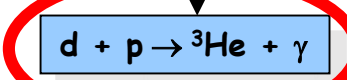
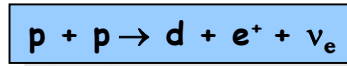

84.7 %

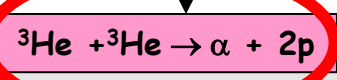

13.8 %

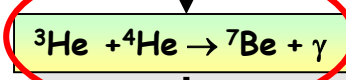

13.78 %

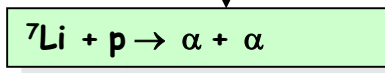
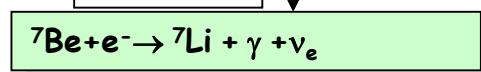

0.02 %

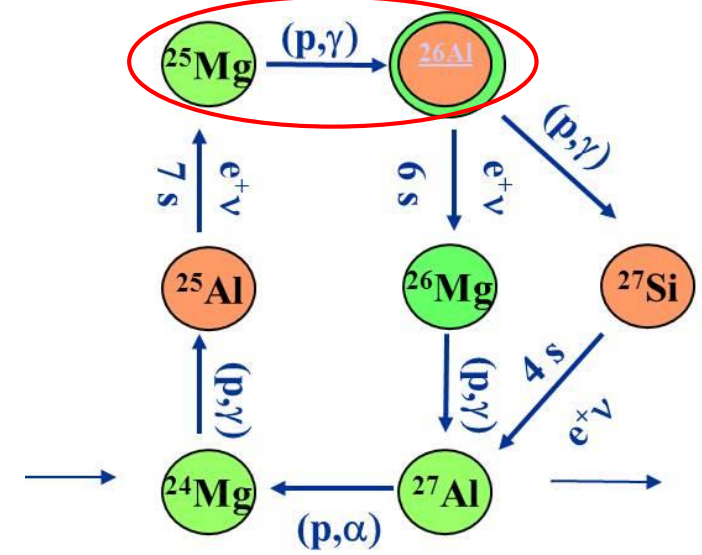
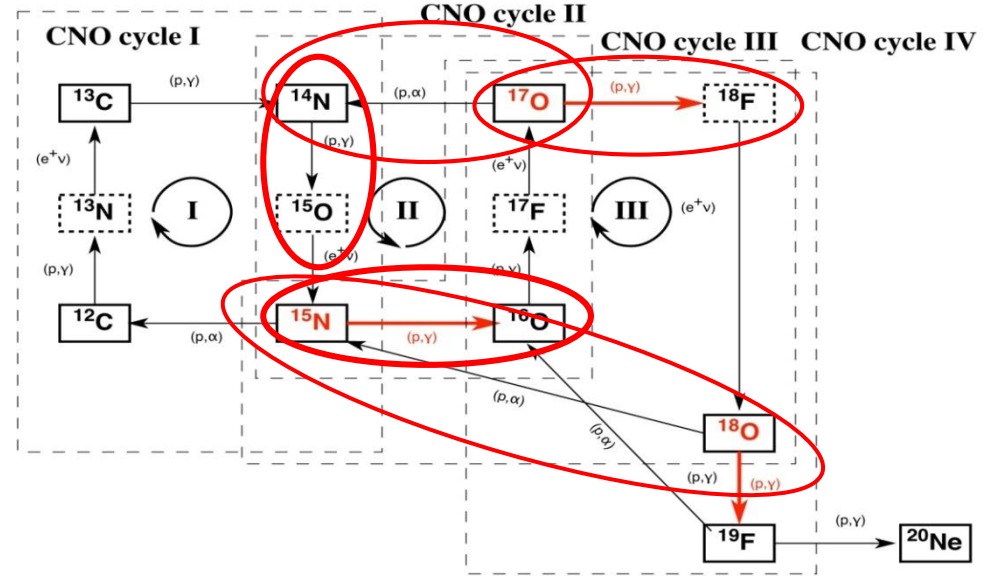
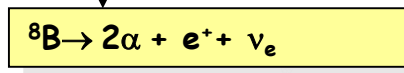
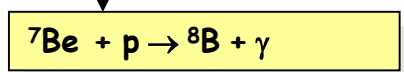

BBN reaction network at LUNA

1. $n \rightarrow p + e^- + \bar{\nu}$
2. $p + n \rightarrow D + \gamma$
3. $D + p \rightarrow {}^3\text{He} + \gamma$
4. $D + D \rightarrow {}^3\text{He} + n$
5. $D + D \rightarrow {}^3\text{H} + p$
6. ${}^3\text{H} + D \rightarrow {}^4\text{He} + n$

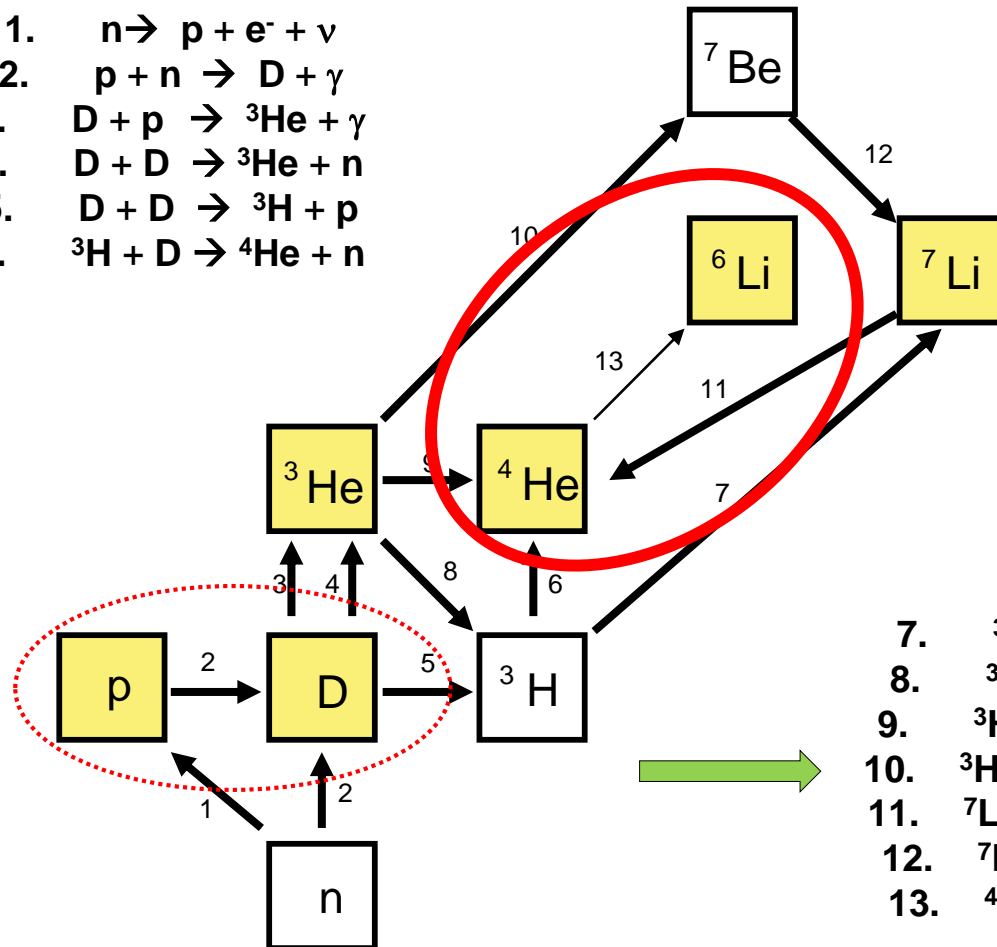

7. ${}^3\text{H} + {}^4\text{H} \rightarrow {}^7\text{Li} + \gamma$
8. ${}^3\text{He} + n \rightarrow {}^3\text{H} + p$
9. ${}^3\text{He} + D \rightarrow {}^4\text{He} + p$
10. ${}^3\text{He} + {}^4\text{He} \rightarrow {}^7\text{Be} + \gamma$
11. ${}^7\text{Li} + p \rightarrow {}^4\text{He} + {}^4\text{He}$
12. ${}^7\text{Be} + n \rightarrow {}^7\text{Li} + p$
13. ${}^4\text{He} + D \rightarrow {}^6\text{Li} + \gamma$

LUNA-MV

LUNA MV will be installed in the North part of Hall B of LNGS

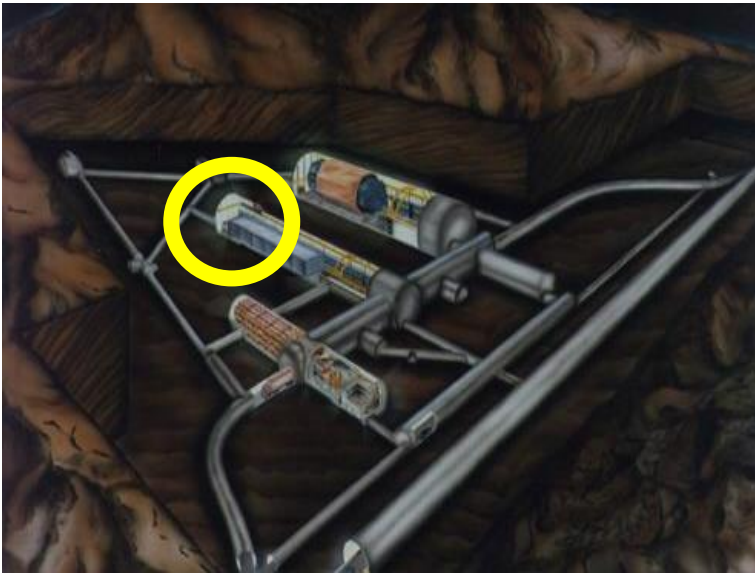

Hall B

(ICARUS decommissioning almost complete – some areas used for OPERA decommissioning storage)

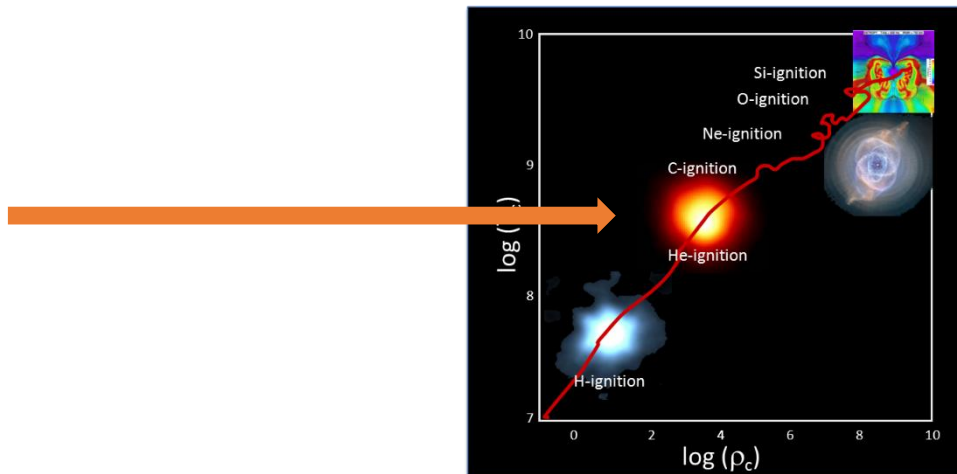



LUNA
Laboratory for Underground
Nuclear Astrophysics

Layout of the new LUNA-MV facility

Thanks to MIUR by 2
«progetti premiale»
total grant: **5.3 M€**

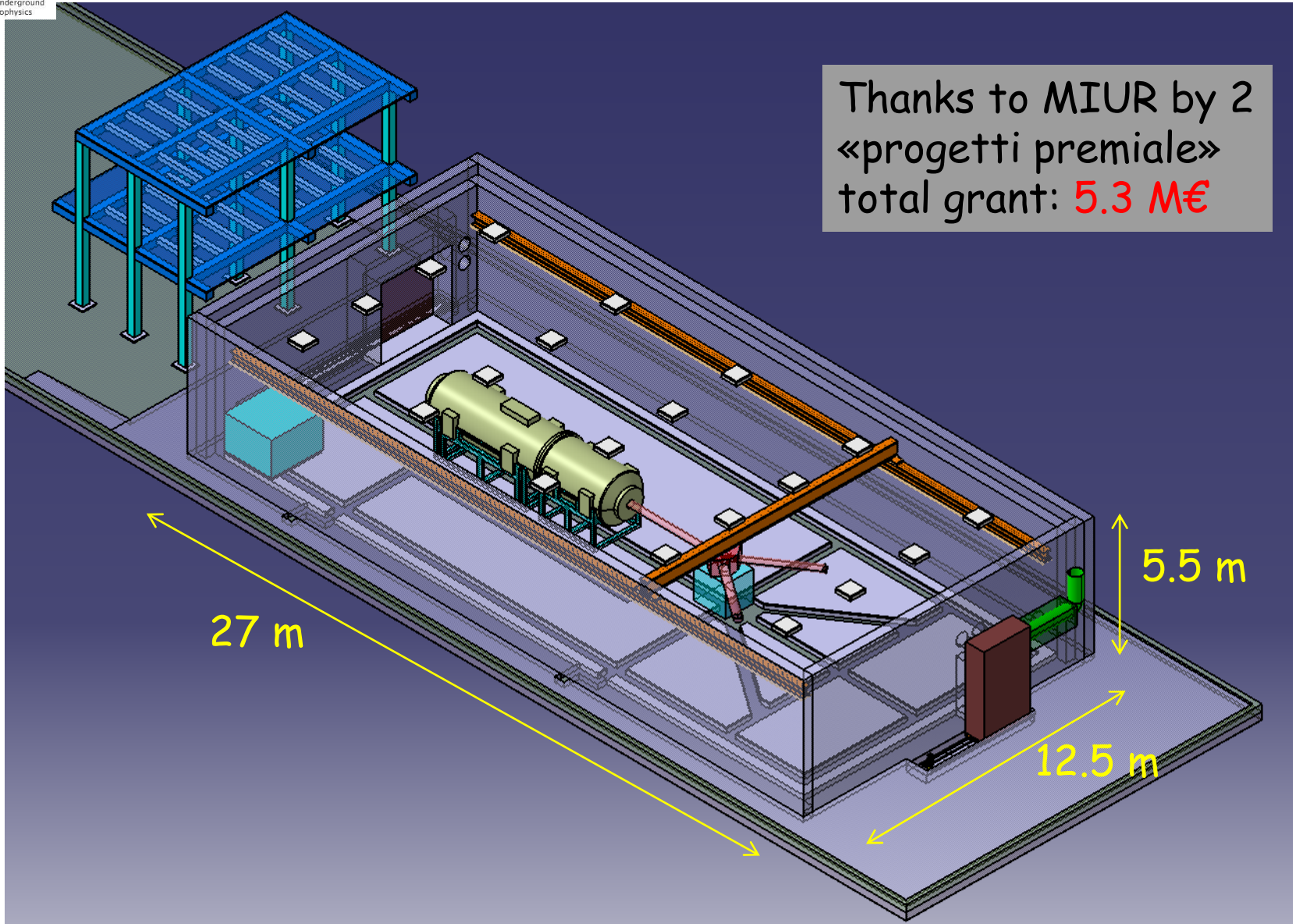

12.1 ECR ion source Model SO-201

- 1. Gas type:** **HELIUM**
Purity level: 99.999% (grade 5)
Bottle: Lecture bottle type LB including outlet valve CGA 180, capacity 0.4 liters, dimensions 51 mm OD x 375 mm OAL
Charging pressure: 150 bar
- 2. Gas type:** **HYDROGEN**
Purity level: 99.999% (grade 5)
Bottle: Lecture bottle type LB including outlet valve CGA 180, capacity 0.4 liters, dimensions 51 mm OD x 375 mm OAL
Charging pressure: 150 bar
- 3. Gas type:** **CARBON DIOXIDE**
Purity level: 99.995% (grade 4.5)
Bottle: Lecture bottle type LB including outlet valve CGA 180, capacity 0.4 liters, dimensions 51 mm OD x 375 mm OAL
Charging pressure: 120 bar

Thanks to the C beam ,
experiments in inverse cinematic will be possible

LUNA-MV basic performance

- Servicing interval : > 700 hrs (at max beam intensity (1000 uA))
- Annual operation capability : > 7400 hrs (at max beam intensity)
- Beam currents****

$^1\text{H}^+$ (TV: 0,3 – 0,5 MV)	:	500 eμA	(700 uA)
$^1\text{H}^+$ (TV: 0,5 – 3,5 MV)	:	1000 eμA	(1200 uA)
$^4\text{He}^+$ (TV: 0,3 – 0,5 MV)	:	300 eμA	(400 uA)
$^4\text{He}^+$ (TV: 0,5 – 3,5 MV)	:	500 eμA	(700 uA)
$^{12}\text{C}^+$ (TV: 0,3 – 0,5 MV)	:	100 eμA	(120 uA)
$^{12}\text{C}^+$ (TV: 0,5 – 3,5 MV)	:	150 eμA	(200 uA)
$^{12}\text{C}^{2+}$ (TV: 0,5 – 3,5 MV)	:	100 eμA	(100 uA)
- Terminal voltage Ripple (Rms) : 20 -80 V
- Precision of terminal voltage reading : 350 V
- Beam energy reproducibility : $1e-4 * \text{TV}$ or 50V, whichever is higher
- Beam energy stability (1 hrs)** : $1e-5 * \text{TV}$ or 20V, whichever is higher
- Beam current stability (1 hrs)***
 - : 5% guaranteed
 - : 2% estimated
 - : 1% (using feedback of target current)
- Beam current stability (1 min)*** : 2%

The accelerator and the neutron shielding







$^1\text{H}^+$ (TV: 0.3 - 0.5 MV): 500 μA
 $^1\text{H}^+$ (TV: 0.5 - 3.5 MV): 1000 μA



$^4\text{He}^+$ (TV: 0.3 - 0.5 MV): 300 μA
 $^4\text{He}^+$ (TV: 0.5 - 3.5 MV): 500 μA



$^{12}\text{C}^+$ (TV: 0.3 - 0.5 MV): 100 μA
 $^{12}\text{C}^+$ (TV: 0.5 - 3.5 MV): 150 μA
 $^{12}\text{C}^{++}$ (TV: 0.5 - 3.5 MV): 100 μA

 porte cemento
 pavimento cemento
 pareti cemento
 sorgente

- inline Cockcroft Walton accelerator
- **TERMINAL VOLTAGE: 0.2 – 3.5 MV**
- Precision of terminal voltage reading: 350 V
- Beam energy reproducibility: 0.01% TV
- Beam energy stability: 0.001% TV / h
- Beam current stability: < 5% / h

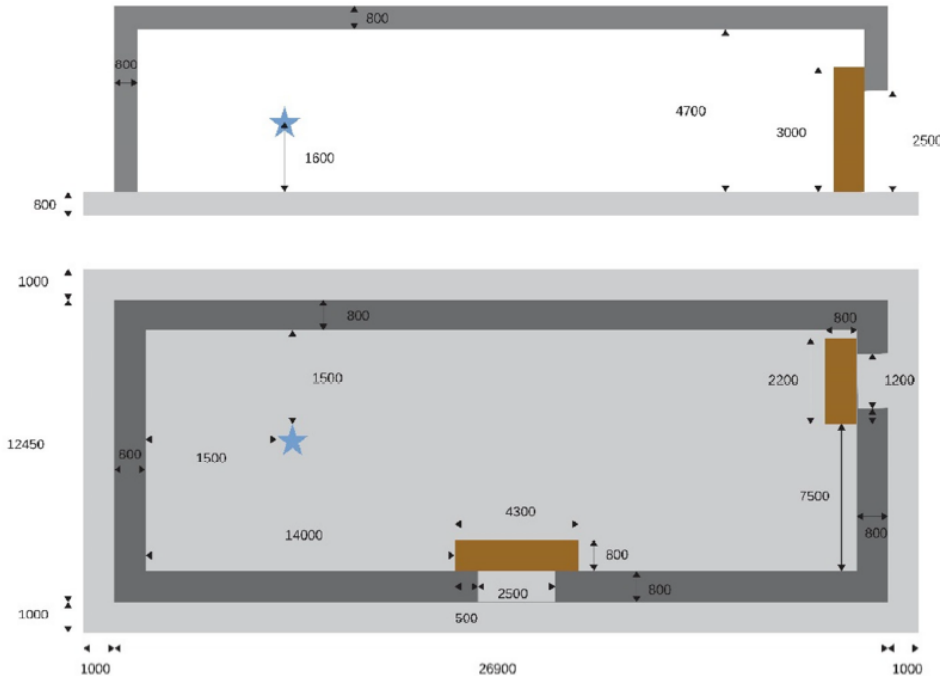

- 80 cm thick concrete shielding calculated by GEANT4 & MCNP
- $E_n = 5.6 \text{ MeV}$, $2 \cdot 10^3 \text{ n/s}$, isotropic

MCNP: $\Phi_n = 1.38 \cdot 10^{-7} \text{ n}/(\text{cm}^2 \text{ s})$
GEANT4: $\Phi_n = 3.40 \cdot 10^{-7} \text{ n}/(\text{cm}^2 \text{ s})$

$\Phi_n(\text{LNGS}) = 3 \cdot 10^{-6} \text{ n}/(\text{cm}^2 \text{ s})$



LUNA-MV : schedule

Action	Date
Approval of the first HVEE technical design	October 2016
Opening of the tendering procedure for LUNA-MV plants	November 2016
Submission of the Authorization request to «Prefettura dell'Aquila»	December 2016
Beginning of the clearing works in Hall B	February 2017
End of the tendering procedure for the new LUNA-MV building	June 2017
Beginning of the construction works in Hall B	December 2017
End of the tendering procedure for LUNA-MV plants	October 2017
Beginning of the construction of the plants in the LUNA-MV building	March 2018
In-house acceptance test for the new LUNA-MV accelerator	February 2018
Completion of the new LUNA-MV building and plants	September 2018
LUNA-MV accelerator delivering at LNGS	December 2018
Conclusion of the commissioning phase	May 2019
Beginning First Experiment	June 2019



ON TIME



LUNA MV- scientific program (2018/9 → 2022/3)

Commissioning measurement: $^{14}\text{N}(p,\gamma)^{15}\text{O}$. High scientific interest for revised data covering a wide energy range (400 keV- 3.5 MeV). Scientific results of high impact but reduced risk immediately after commissioning phase

$^{12}\text{C}+^{12}\text{C}$: solid state target. Gamma and particle detection.

$^{13}\text{C}(\alpha,n)^{16}\text{O}$: enriched ^{13}C solid or gas target.

Data taking at LUNA 400 kV in 2017-2018.

$^{22}\text{Ne}(\alpha,n)^{25}\text{Mg}$: enriched ^{22}Ne gas target.

Next steps (not before 2023...):

$^{12}\text{C}(\alpha,\gamma)^{16}\text{O}$: ^{12}C solid target depleted in ^{13}C and alpha beam or α jet gas target and ^{12}C beam.

Carbon burning: toward the final fate of the stars

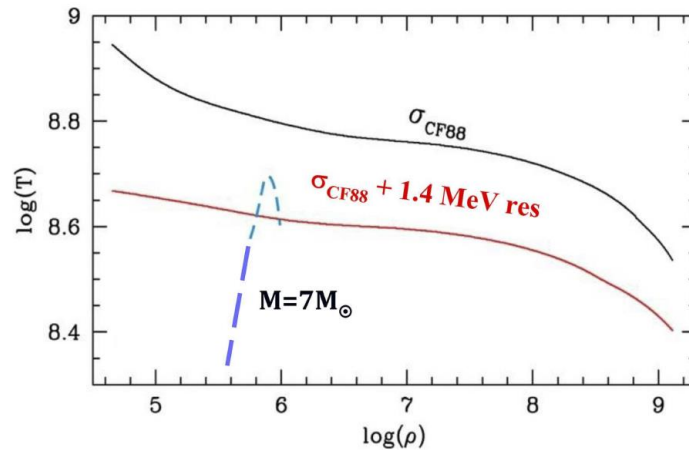
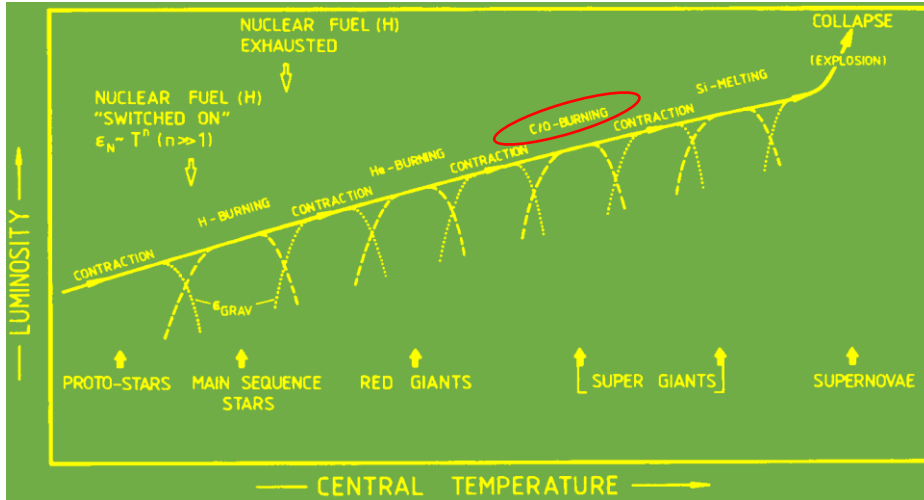
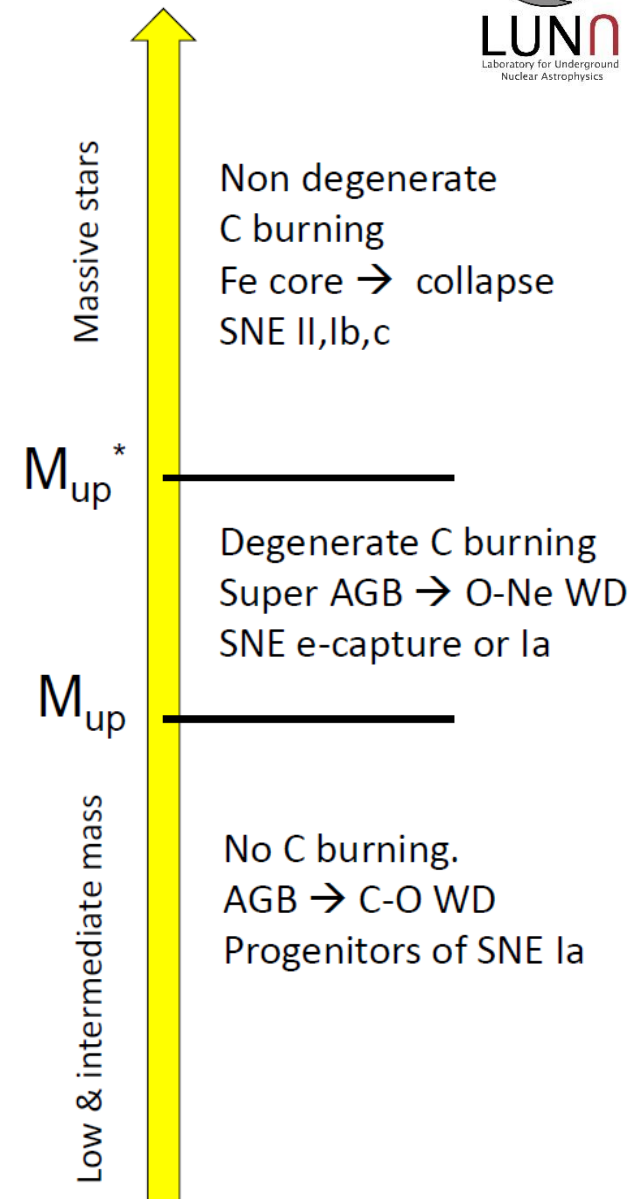
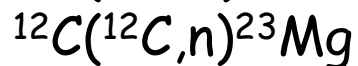
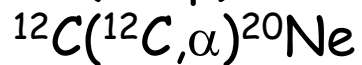

Figure 5: C ignition curves with different $^{12}\text{C}+^{12}\text{C}$ as defined as the loci where the rate of nuclear energy production ($^{12}\text{C}+^{12}\text{C}$) is equal to the rate of plasma-neutrino energy loss (solid line). C burning occurs when the (T, ρ) in the stellar core cross this line. Different $^{12}\text{C}+^{12}\text{C}$ rate have been used: Caughlan and Fowler 1988 (CF88, black line) and CF88 plus the artificial contribution from a low energy (1.4 MeV) resonance. The dashed line show the evolutionary track of the maximum temperature layer in the core of a star with initial mass $7 M_{\odot}$. For this particular model, the conditions for the C ignition are attained only if the artificial contribution to the $^{12}\text{C}+^{12}\text{C}$ rate is included.



The challenging measurement of $\sigma(^{12}\text{C}+^{12}\text{C})$



$Q = 2.241 \text{ MeV}$

$Q = 4.617 \text{ MeV}$

$Q = -2.599 \text{ MeV}$

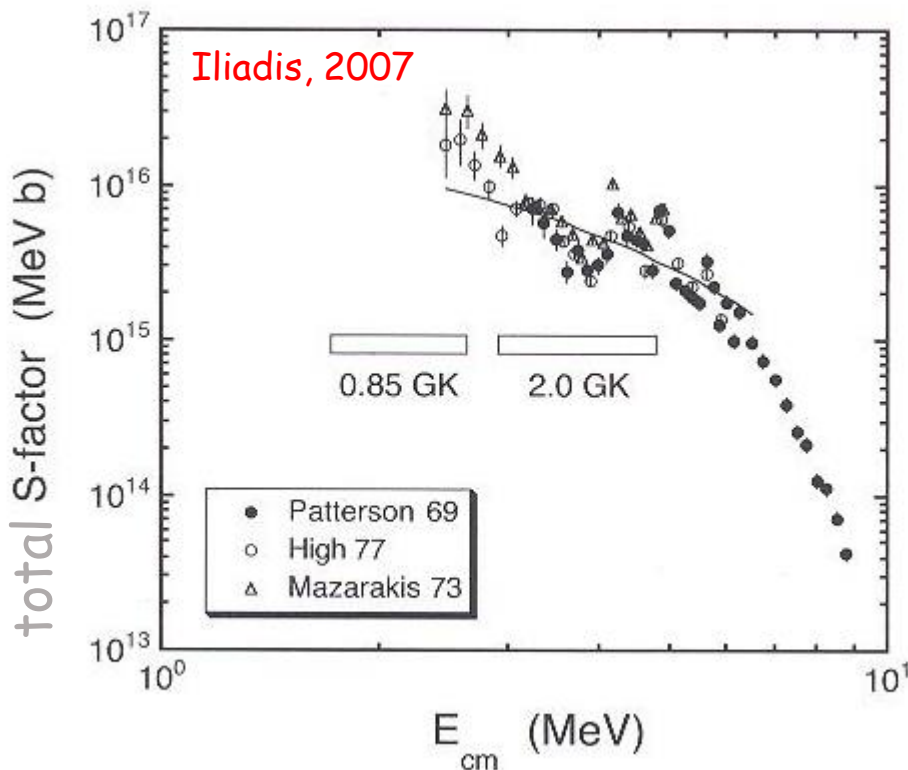

LUNA-MV proposal, 2016

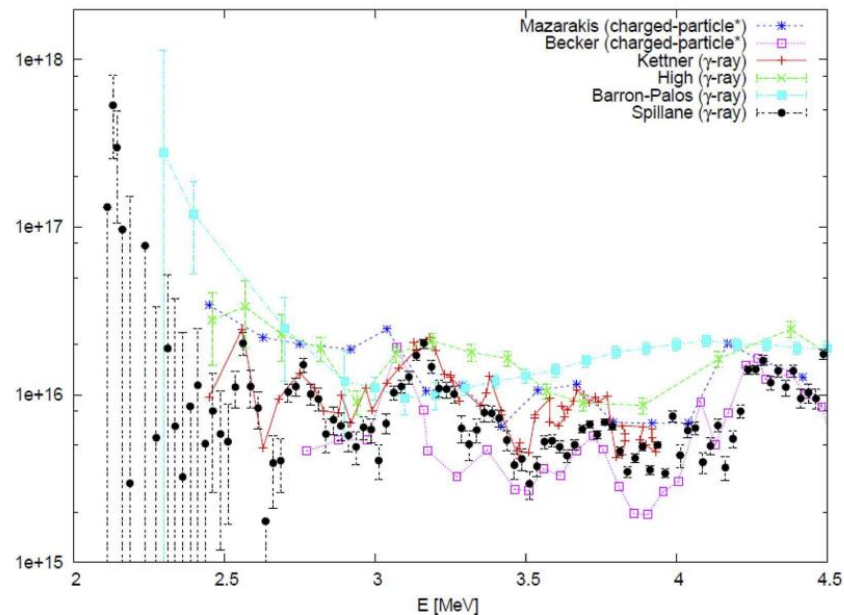

Figure 6: Modified astrophysical S factor relative to the 1634 keV transition (i.e., the de-excitation of the first excited state of ^{20}Ne populated by the $^{12}\text{C}(^{12}\text{C},\alpha)^{20}\text{Ne}$ reaction).



The LUNA collaboration

- **L. Csedreki**, **G.F. Ciani***, L. Di Paolo, A. Formicola, **I. Kochanek**, M. Junker | INFN LNGS /*GSSI, Italy
- D. Bemmerer, **K. Stoeckel**, **M. Takacs**, | HZDR Dresden, Germany
- C. Brogгинi, **A. Caciolli**, **R. Depalo**, P. Marigo, R. Menegazzo, **D. Piatti** | Università di Padova and INFN Padova, Italy
- C. Gustavino | INFN Roma1, Italy
- Z. Elekes, Zs. Fülöp, Gy. Gyurky, T. Szucs | MTA-ATOMKI Debrecen, Hungary
- M. Lugaro | Monarch University Budapest, Hungary
- O. Straniero | INAF Osservatorio Astronomico di Collurania, Teramo, Italy
- **F. Cavanna**, P. Corvisiero, **F. Ferraro**, P. Prati, S. Zavatarelli | Università di Genova and INFN Genova, Italy
- A. Guglielmetti | Università di Milano and INFN Milano, Italy
- A. Best, A. Di Leva, G. Imbriani, | Università di Napoli and INFN Napoli, Italy
- G. Gervino | Università di Torino and INFN Torino, Italy
- M. Aliotta, **C. Bruno**, T. Davinson | University of Edinburgh, United Kingdom
- G. D'Erasmus, E.M. Fiore, **V. Mossa**, **F. Pantaleo**, V. Paticchio, R. Perrino, L. Schiavulli, A. Valentini | Università di Bari and INFN Bari, Italy





LUNN
Laboratory for Underground
Nuclear Astrophysics

Back-up slides



LUNA-MV: neutron flux monitoring

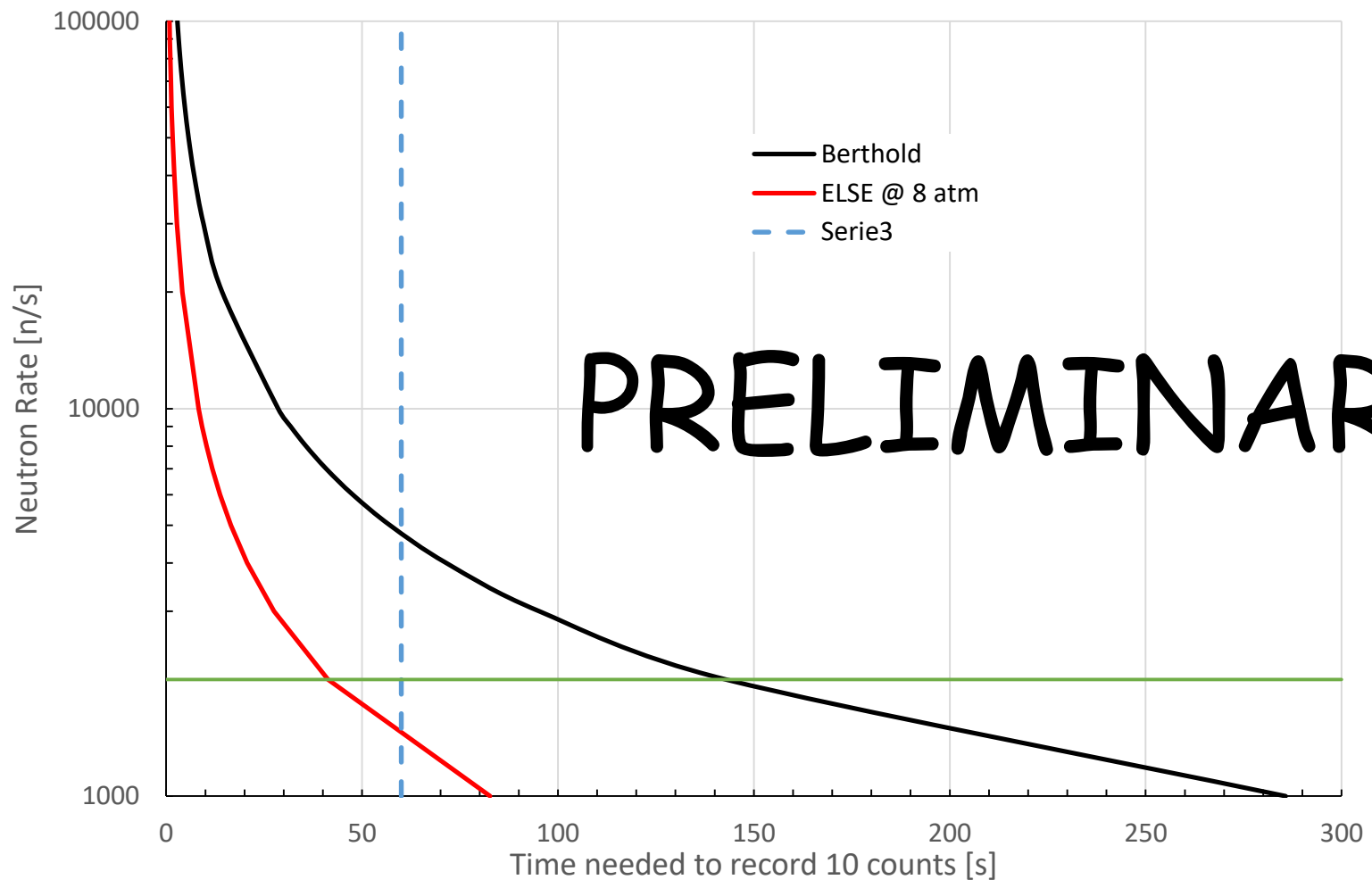

PRELIMINARY

$^{13}\text{C}(\alpha, n)^{16}\text{O}$: astrophysical impact

The reaction takes place in thermally pulsating, low-mass, Asymptotic Giant Branch stars at Gamow energies $E = 140 - 230 \text{ keV}$ ($T = 90 - 10^6 \text{ K}$).

The cosmic creation of roughly half of all elements heavier than iron, occurs in AGB stars, where the neutrons necessary to drive the slow neutron-capture (s) process are released by the $^{13}\text{C}(\alpha, n)$.

Radiativ: i.e inter-pulse \rightarrow lower n density
Convective: i.e partially in-pulse \rightarrow higher n density

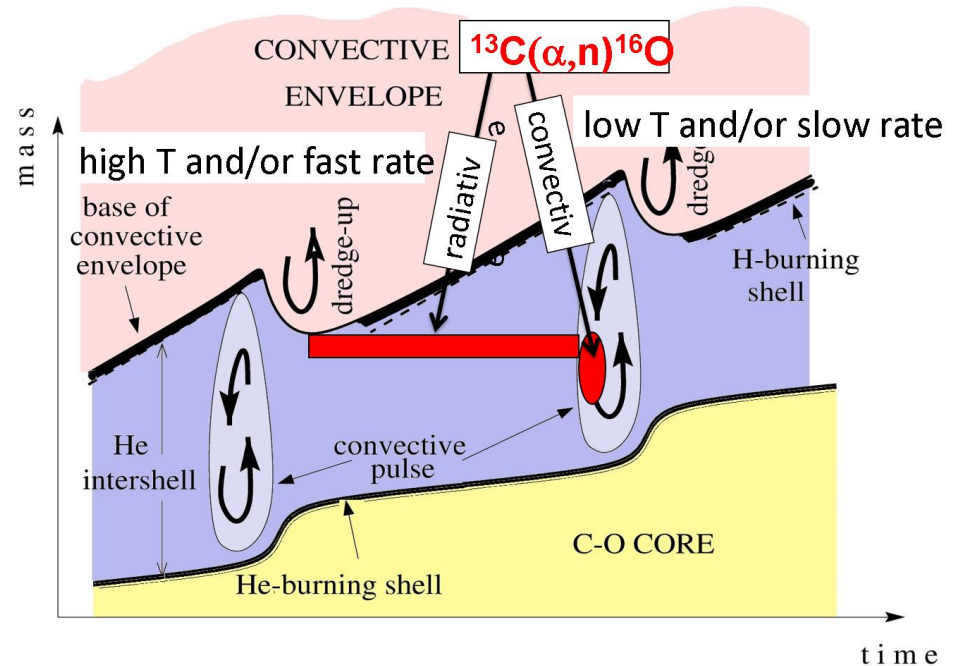
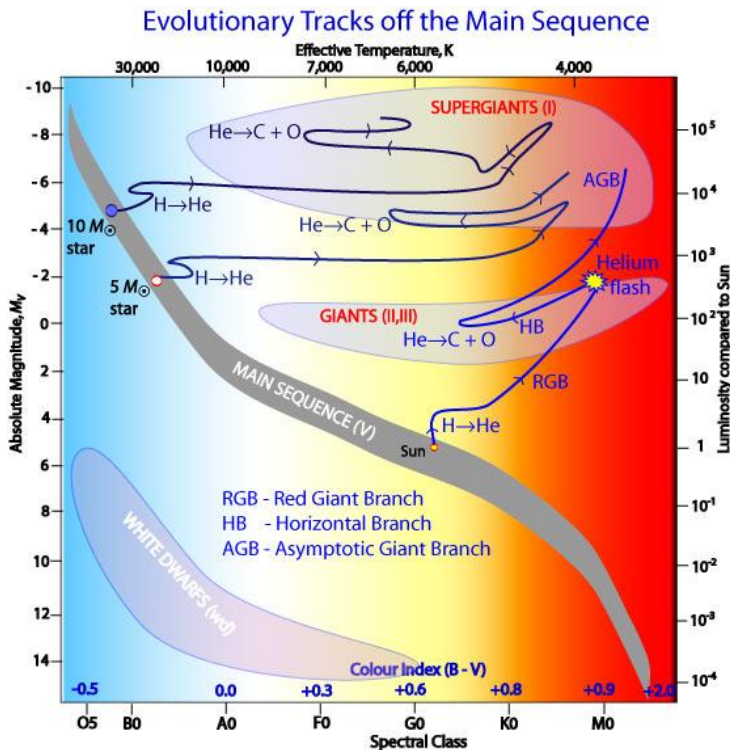

$^{13}\text{C}(\alpha,n)^{16}\text{O}$: extrapolation to the Gamow window

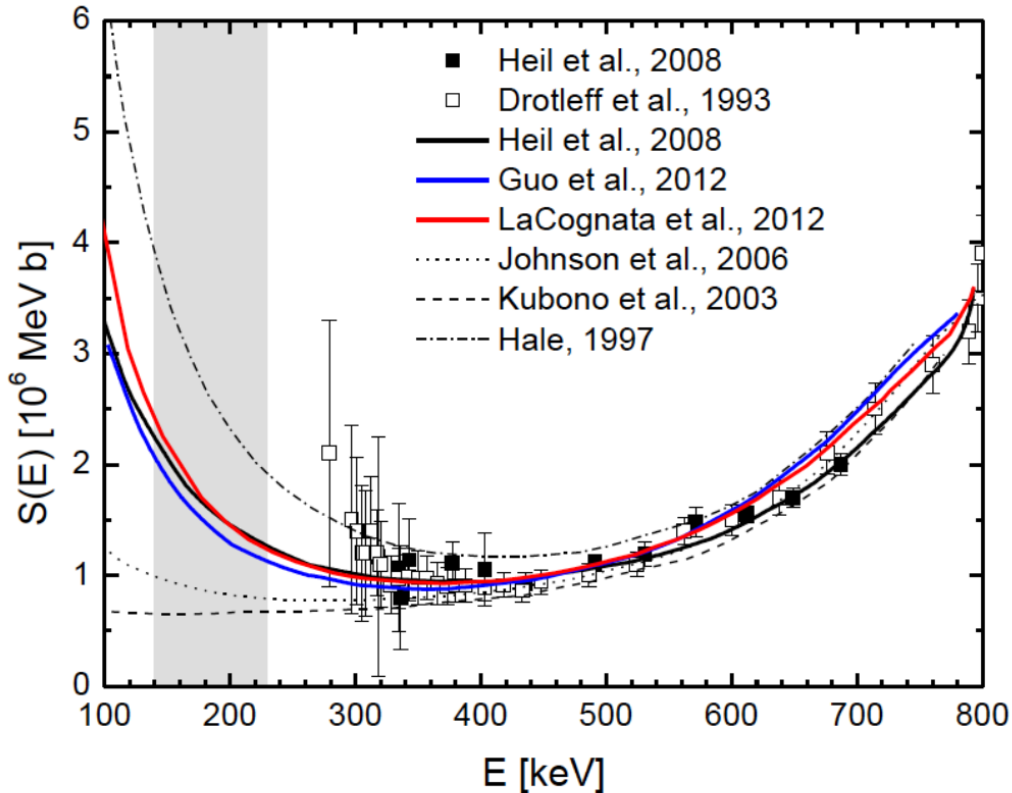

some conclusion:

- low energy data points do not constrain the fit with respect to the subthreshold resonance
- quoted uncertainties are large
 - probably also a mixture of systematic and statistical uncertainties, e.g. in Drotleff scattering of data is unexpectedly small with respect to error bars
- most data point below $E = 350$ keV are higher than the fit curves, i.e. Heil R-matrix curve
 - indication for beam induced background?

Astrophysical requirements : uncertainty on $S(E) < 10\%$

$^{12}\text{C}(\alpha,\gamma)^{16}\text{O}$: literature data for the S-factor

4 reaction/month with $I \sim 1 \text{ mA}$!!!

$\sigma(300 \text{ keV}) \sim 10^{-8} \text{ nb}$

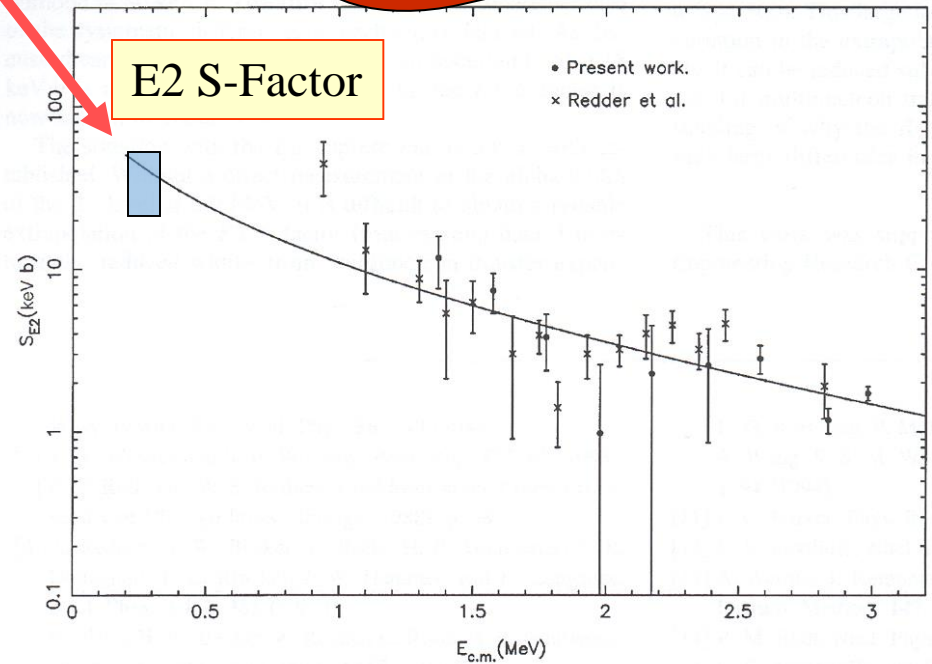
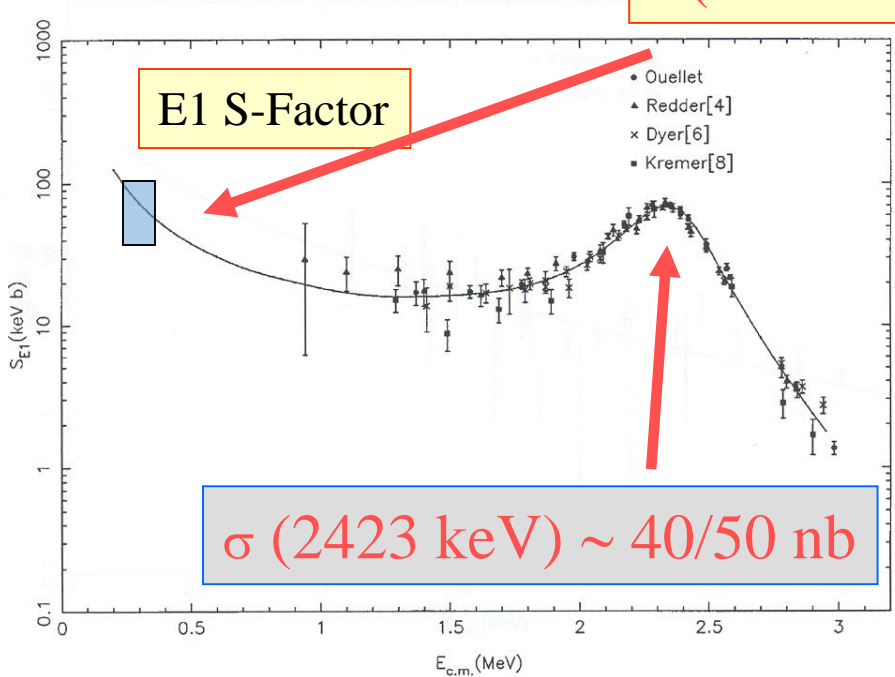

Ouellet et al. Phys. Rev. C 54 4 (1996) 1982-1998

Lowest energy directly investigated: 940 keV c.m.

LUNA and the others

	Bck.	Acceler.	Beam intensity	Program	Expected start	Notes
LUNA	LNGS	LUNA 400	~300 μ A	$^{13}\text{C}(\alpha, n)$ et al.,	2017	Solid target
JUNA	~ 2 OoM better	400 kV – ECR	10 mA !	$^{25}\text{Mg}(p, \gamma)$ $^{13}\text{C}(\alpha, n)$ $^{12}\text{C}(\alpha, \gamma)$	Mid 2016 2019	Gas target + ^3He tubes in liq. Scint.
CASPAR	~ LUNA	Old 1 MV	150 μ A	$^{14}\text{N}(p, \gamma)$? $^{13}\text{C}(\alpha, n)$ $^{22}\text{Ne}(\alpha, n)$	Mid 2016 ? ?	Gas target + ^3He tubes
LUNA MV	LNGS	3.5 MV + ECR	1 mA	$^{14}\text{N}(p, \gamma)$? $^{13}\text{C}(\alpha, n)$ $^{22}\text{Ne}(\alpha, n)$ $^{12}\text{C}(\alpha, \gamma)$ $^{12}\text{C} + ^{12}\text{C}$	2019 ? ? ? ?	

Starting from 2017 LUNA will be no more alone !

Interest in a new ${}^2\text{H}(p,\gamma){}^3\text{He}$ measurement

BBN provides a precise estimate of Baryon density Ω_b , through the comparison of $(\text{D}/\text{H})_{\text{BBN}}$ and $(\text{D}/\text{H})_{\text{obs}}$:

Assuming the Standard Model

- $100\Omega_{b,0}h^2(\text{CMB}) = 2.22 \pm 0.02$ (PLANCK 2015)

$d(p,\gamma){}^3\text{He}$ data fit



- $100\Omega_{b,0}h^2(\text{BBN}) = 2.20 \pm 0.04 \pm 0.02$ (Cooke



D/H observations

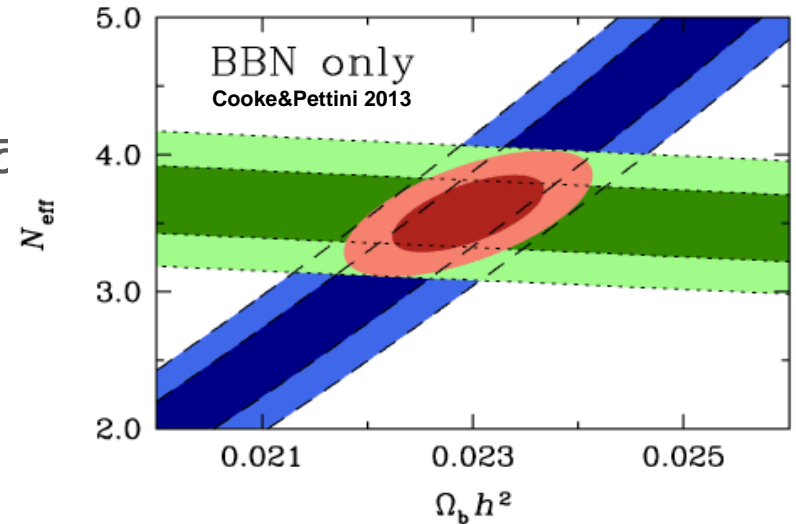

Measurement goal:

Cross section at

$30 \text{ keV} < E_{\text{cm}} < 300 \text{ keV}$

with $\sim (<) 5\%$ accuracy



Physics:

1. Cosmology: measurement of Ω_b
2. Cosmology : measurement of N_{eff}
3. Nuclear physics: comparison of data with "ab initio" predictions

Interest in a new ${}^2\text{H}(p,\gamma){}^3\text{He}$ experiment

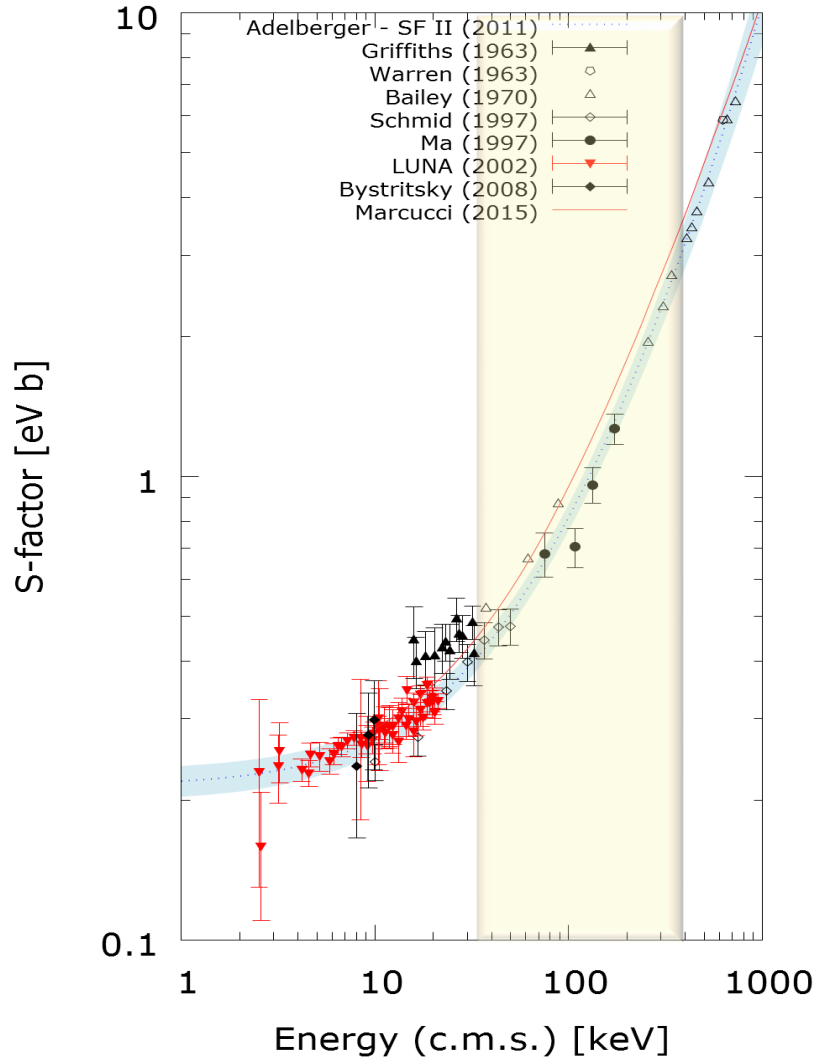

The ${}^2\text{H}(p,\gamma){}^3\text{He}$ reaction is of high interest also in theoretical nuclear physics, in particular for what concern "ab-initio" modelling, as light nuclei are involved in this process



There is a maximum discrepancy of 15% between theoretical predictions (red line) and the best fit of experimental data (blue band)

The difference between theory and the data let some author to adopt the theoretical curve or the S-factor value obtained from measurement.

*Marcucci 2016 *Phys. Rev. Lett.*

*Adelberger 2011 *Rev. Mod. Phys.*

Interest in a new ${}^2\text{H}(p,\gamma){}^3\text{He}$ experiment

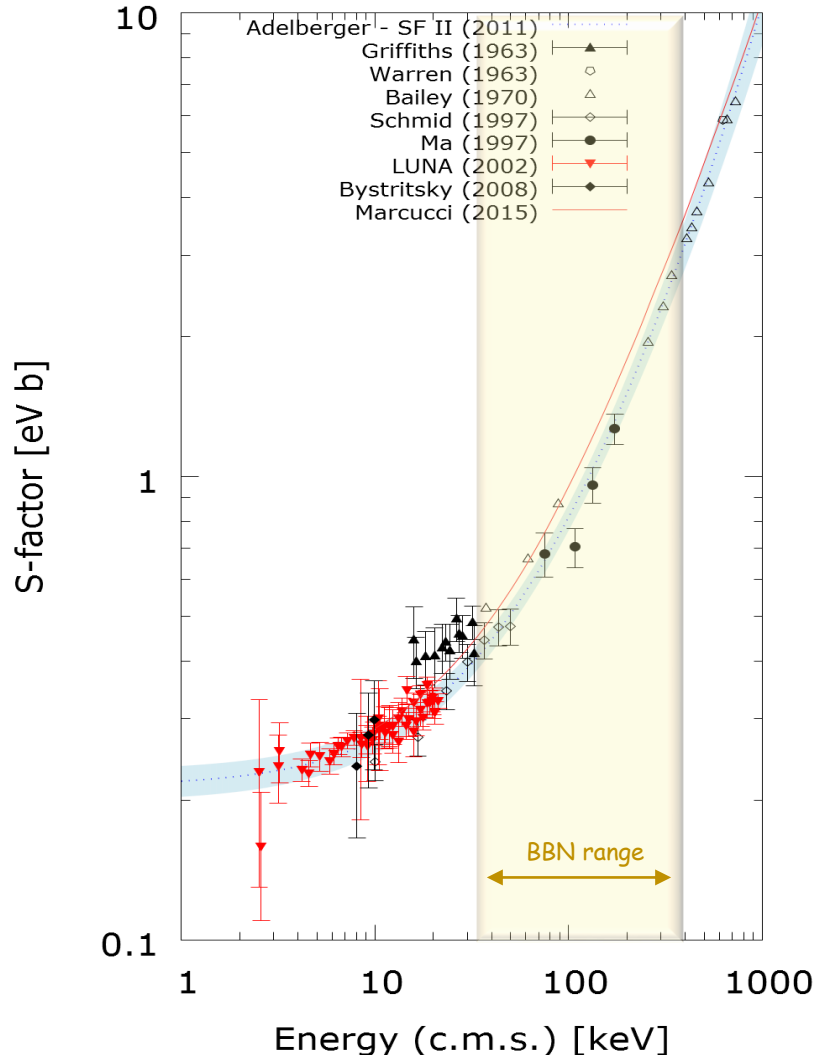

The error budget of computed abundance of deuterium is mainly due to the $d(p,\gamma){}^3\text{He}$ reaction

Reaction	$\sigma_{\text{H}/\text{H}} \times 10^5$
$p(n,\gamma){}^2\text{H}$	± 0.002
$d(p,\gamma){}^3\text{He}$	± 0.062
$d(d,n){}^3\text{He}$	± 0.020
$d(d,p){}^3\text{H}$	± 0.013

*E. Di Valentino et al., Phys. Rev. D 90 (2014) 023543

- Precise low energy data coming from LUNA 50 kV
- Only a single dataset is currently available at the BBN energy range with a systematic error of 9%
- No perfect agreement with recent «Ab-initio» calculations

Ultra low-background gas target set-up based on a 130% HPGe detector

0.4 m³ Pb and Cu shield in a Radon box

→ bck reduction: 10⁵

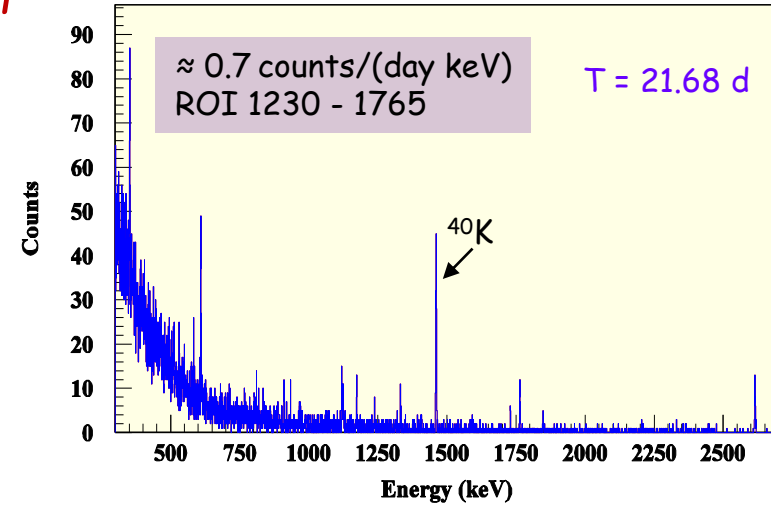
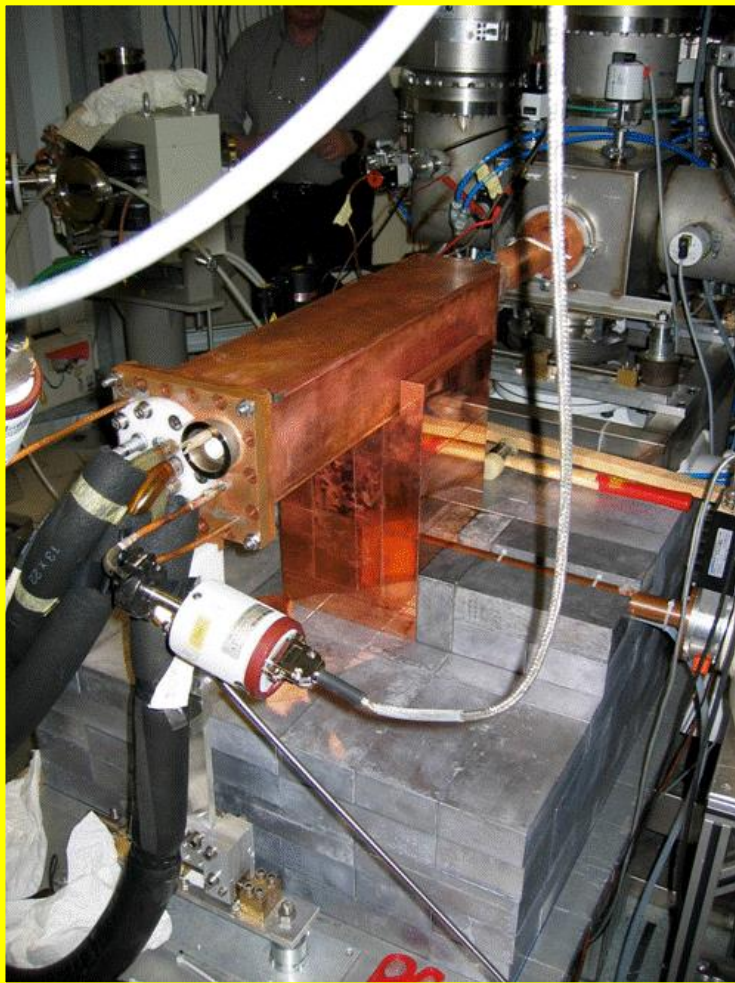

LUNA 400kV accelerator

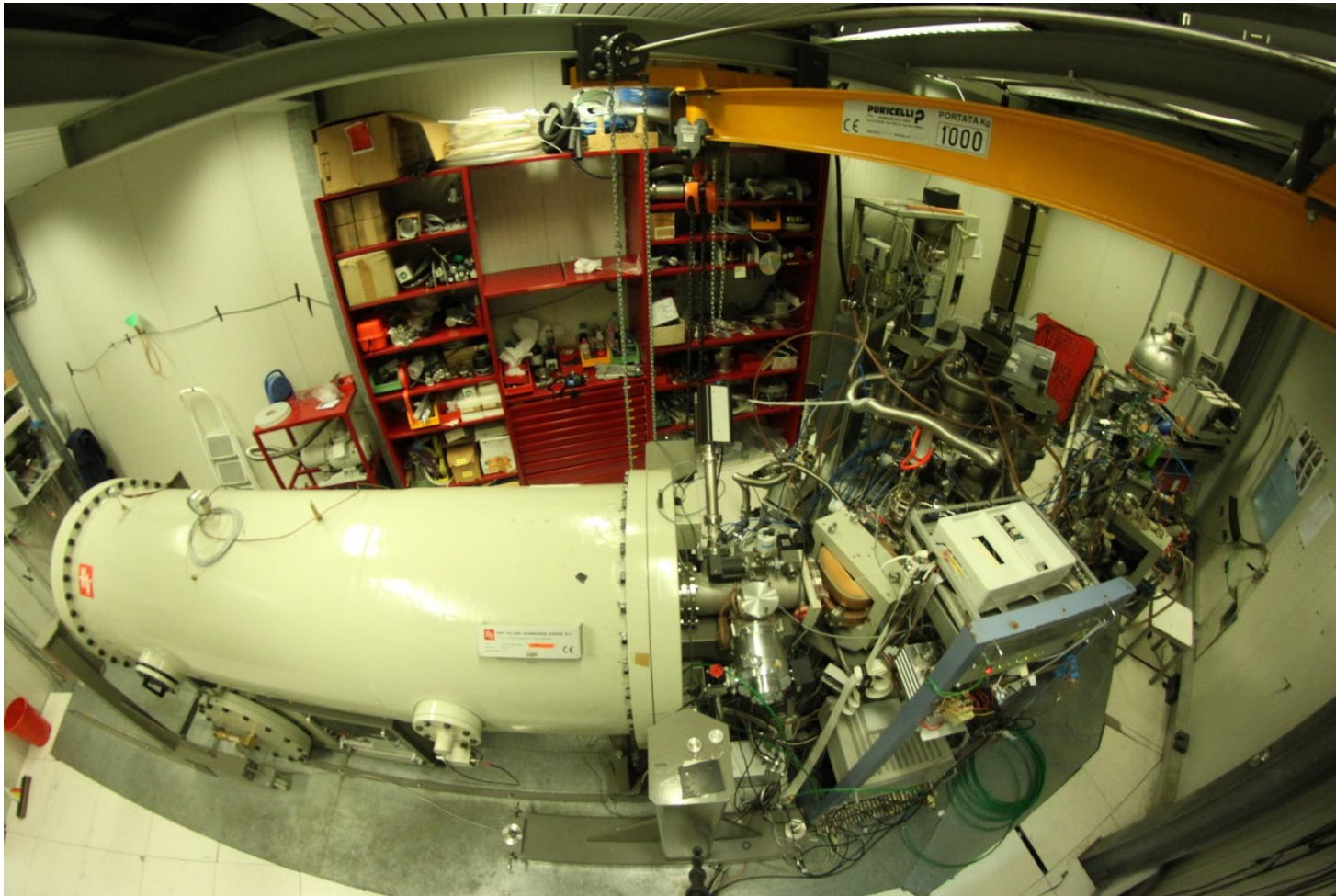

$E_{\text{beam}} \approx 50 - 400 \text{ keV}$

$I_{\text{max}} \approx 500 \mu\text{A}$ protons

Energy spread $\approx 70 \text{ eV}$

$I_{\text{max}} \approx 250 \mu\text{A}$ alphas

Long term stability $\approx 5\text{eV/h}$