

A photonic which-path entangler

Bill Coish

McGill University, Montréal, QC



CAP Congress

University of Western Ontario, London, ON

2024 May 27

More information: Z. M. McIntyre and WAC, Phys. Rev. Lett. **132**, 093603 (2024) [entanglement]
Z. M. McIntyre and WAC, arXiv:2405.13265 [sensing]

Advertisement



Noah Pinkney

Today @ 11:00-11:15 (SSC 2020)
*Entropy-based Bayesian approach
to multi-parameter estimation*

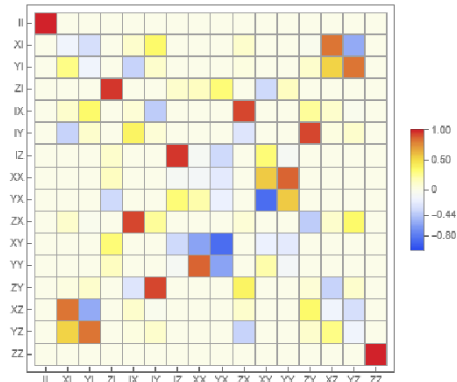

Zoé McIntyre

Today @ 16:45-17:00 (PAB 150)
*Flying-cat parity checks for quantum error
correction and quantum communication*

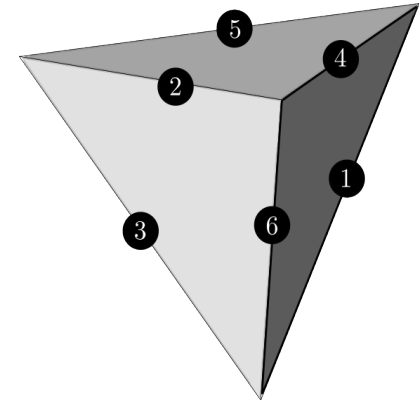

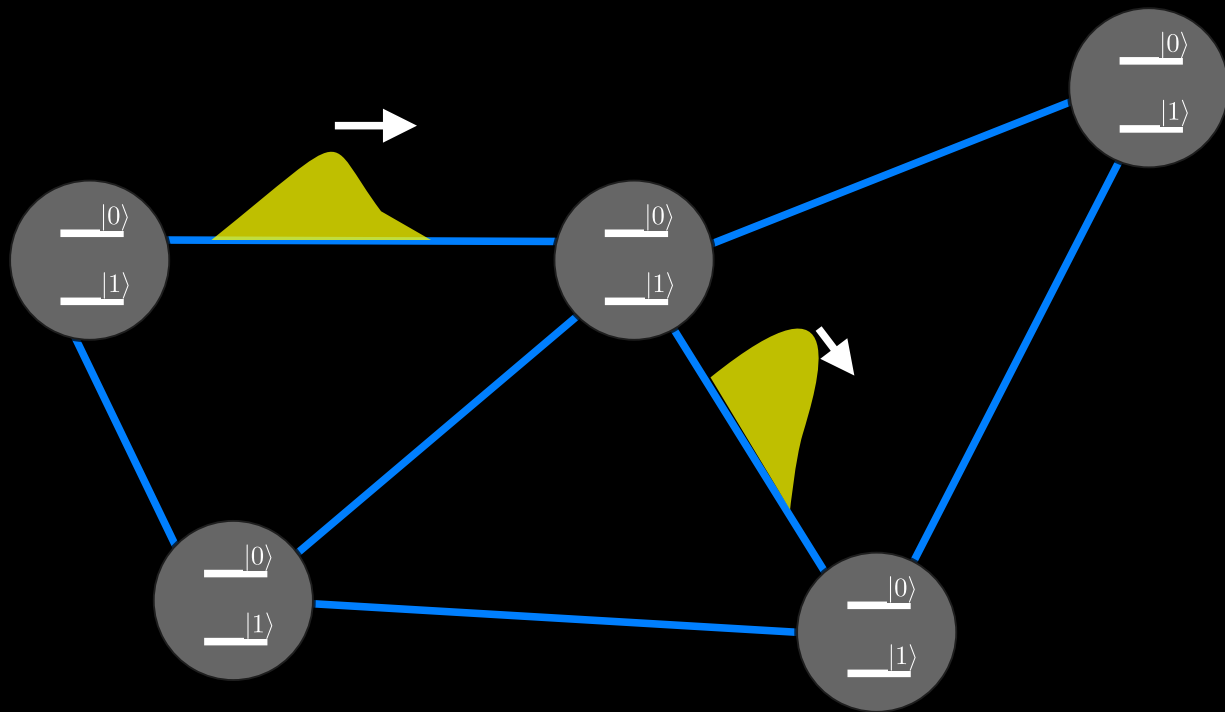

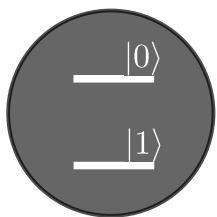

=

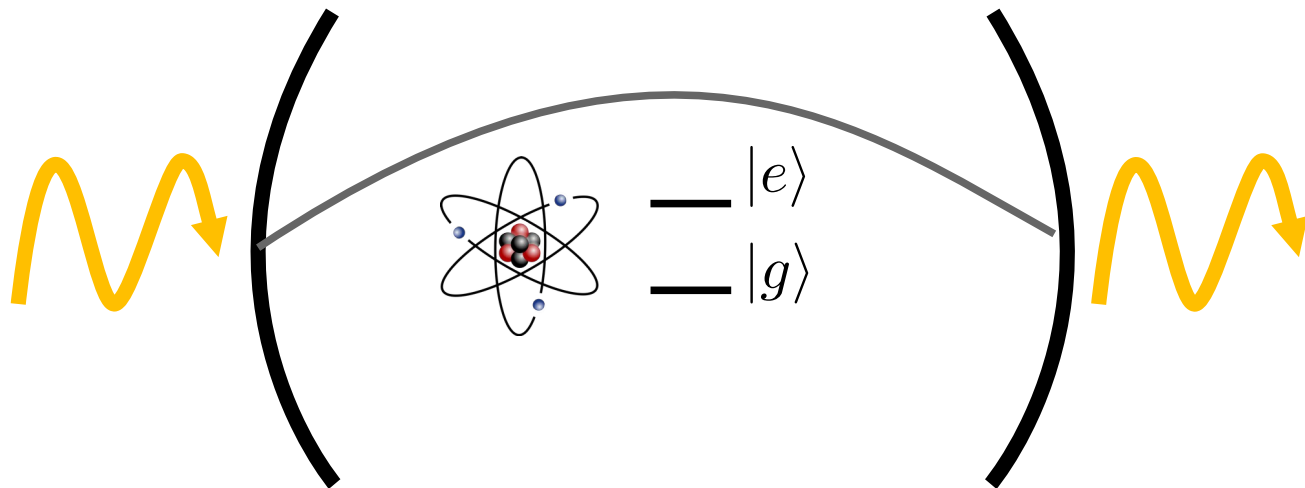

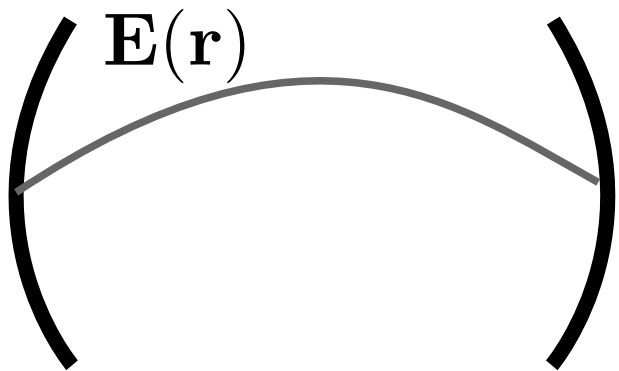

$$\text{Energy} \sim \frac{1}{2} \int d^3r \left(\epsilon_0 E^2(\mathbf{r}) + \frac{1}{\mu_0} B^2(\mathbf{r}) \right)$$

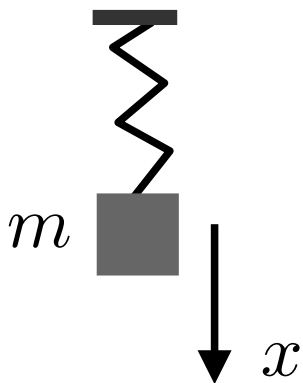

$$\text{Energy} = \frac{p^2}{2m} + \frac{1}{2} m \omega^2 x^2$$

$$H = \hbar \omega \left(n + \frac{1}{2} \right); \quad n = 0, 1, 2, \dots$$

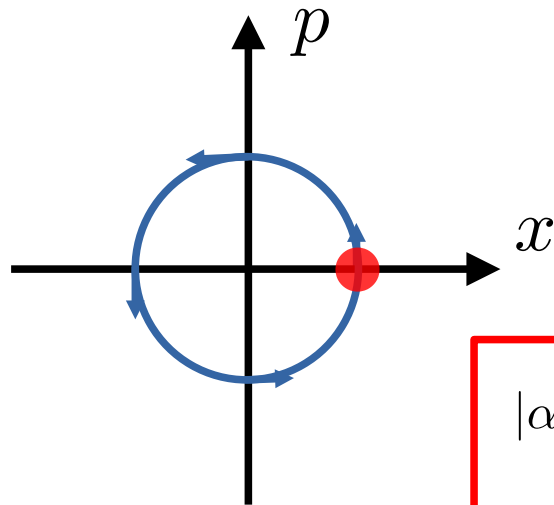
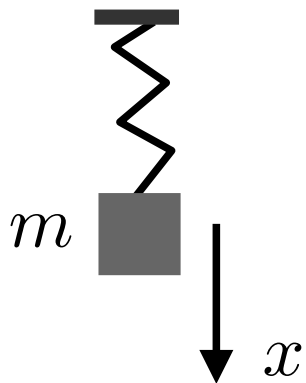

$$|\alpha\rangle = e^{-|\alpha|^2/2} \sum_n \frac{\alpha^n}{\sqrt{n!}} |n\rangle$$
$$a|\alpha\rangle = \alpha|\alpha\rangle$$

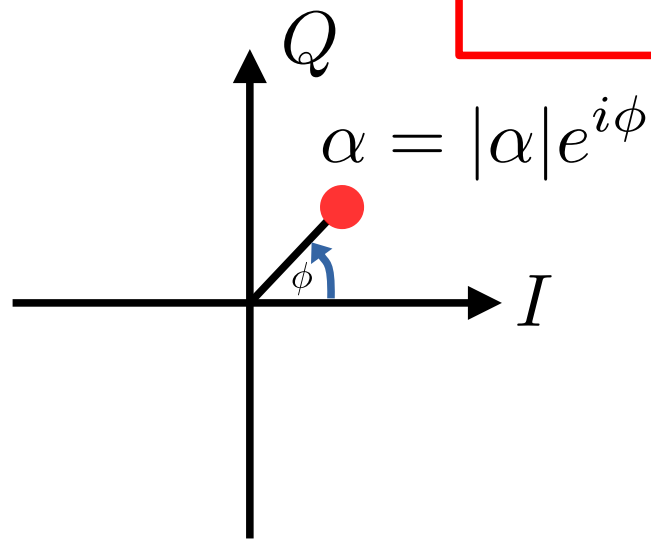
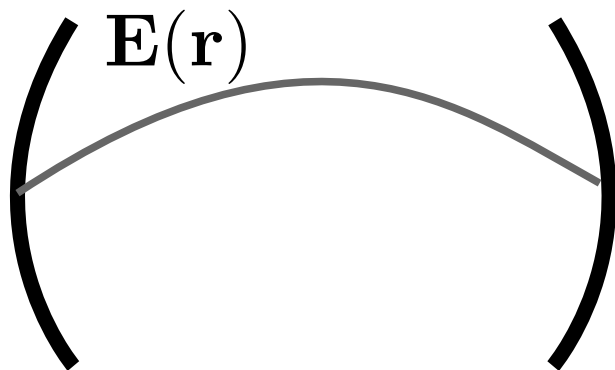

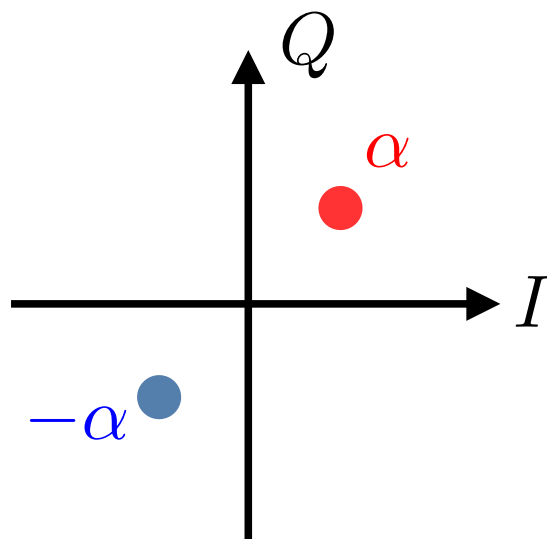
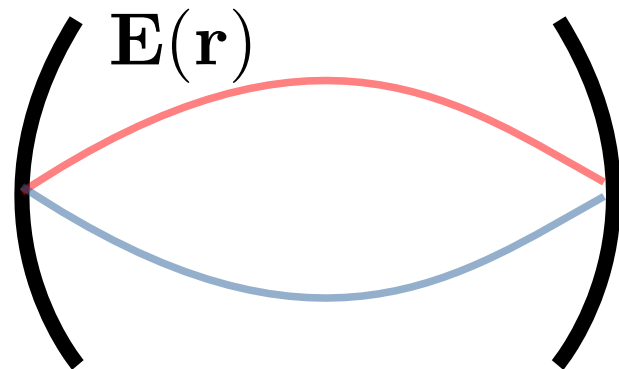
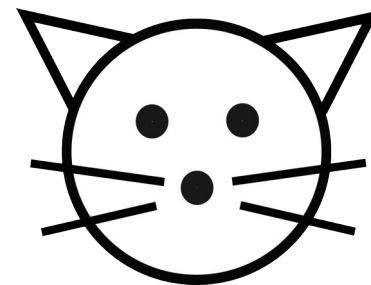
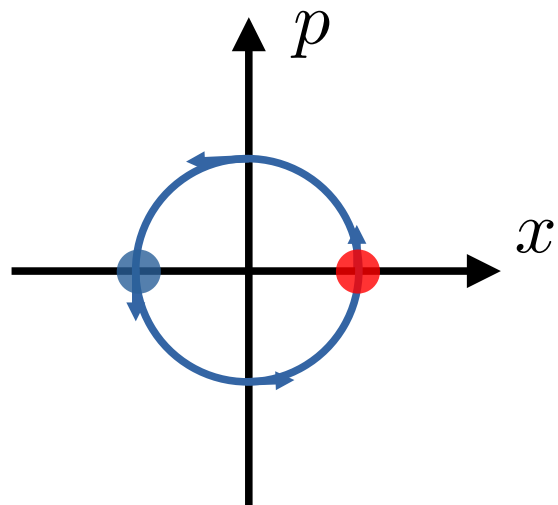
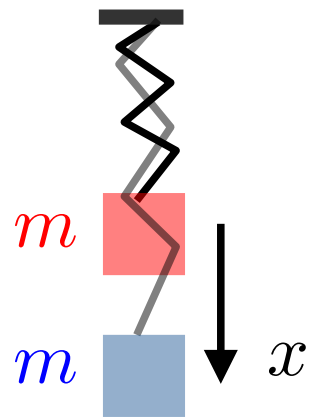

$$|C_{\pm}\rangle \propto |\alpha\rangle \pm |-\alpha\rangle$$

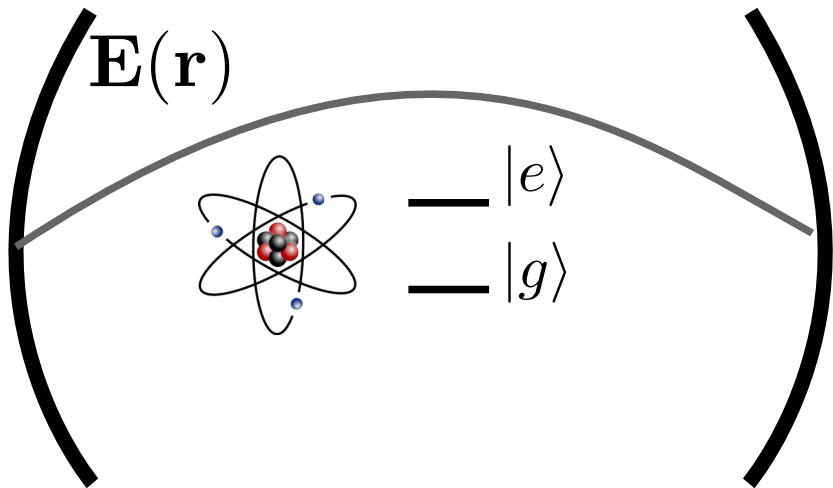

$$H_{\text{dip.}} = e\mathbf{E}(\mathbf{r}_0) \cdot \mathbf{r}$$

$$\mathbf{E}(\mathbf{r}_0) \sim a + a^\dagger$$

$$\sigma_z = |e\rangle \langle e| - |g\rangle \langle g| \quad \sigma_x = |e\rangle \langle g| + |g\rangle \langle e|$$

$$H_{\text{eff}} = g_z \sigma_z (a + a^\dagger) + g_x (a \sigma_+ + a^\dagger \sigma_-)$$

$$g_z \propto \langle e | \mathbf{r} | e \rangle - \langle g | \mathbf{r} | g \rangle \quad g_x \propto \langle e | \mathbf{r} | g \rangle$$

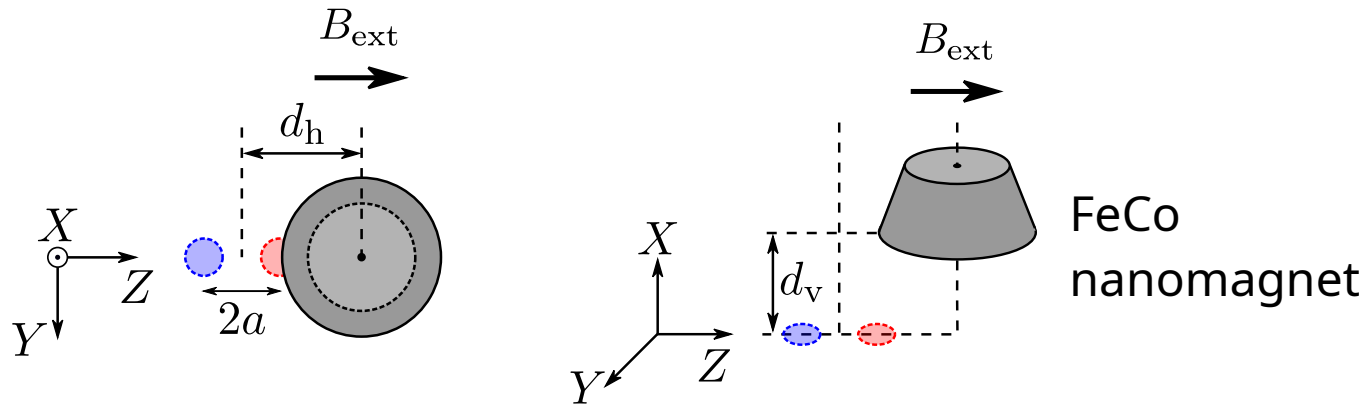

$$H_{\text{eff}} \simeq \boxed{g_z (a^\dagger + a) \sigma_z} + \boxed{g_x (a^\dagger \sigma_- + \sigma_+ a)}$$

Longitudinal

Transverse

Longitudinal parametric readout

$$H(t) = \omega_c a^\dagger a + g_z(t) (a + a^\dagger) \sigma_z$$

$$g_z(t) = \bar{g}_z + \tilde{g}_z \cos(\omega_c t)$$

Qubit-state-dependent displacement:

$$H_{\text{RWA}} = \tilde{g}_z (a + a^\dagger) \sigma_z$$

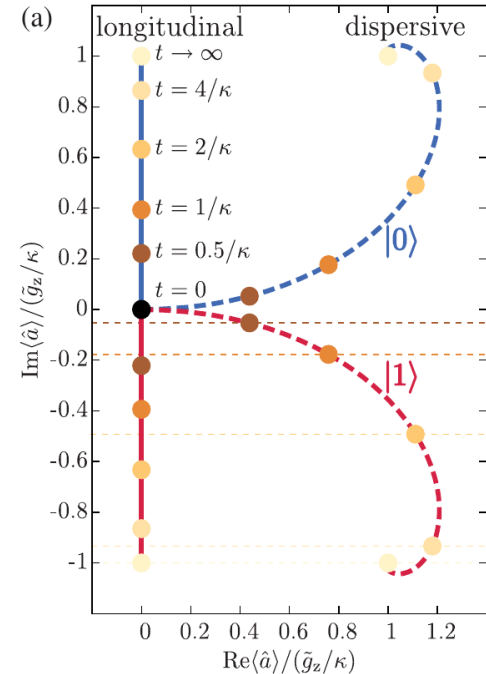
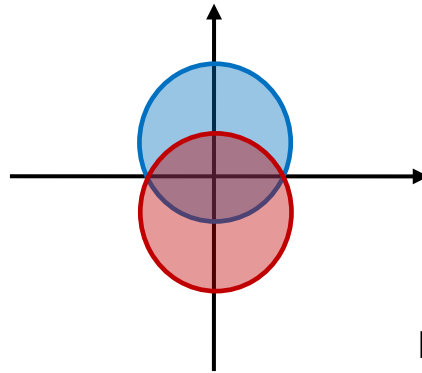

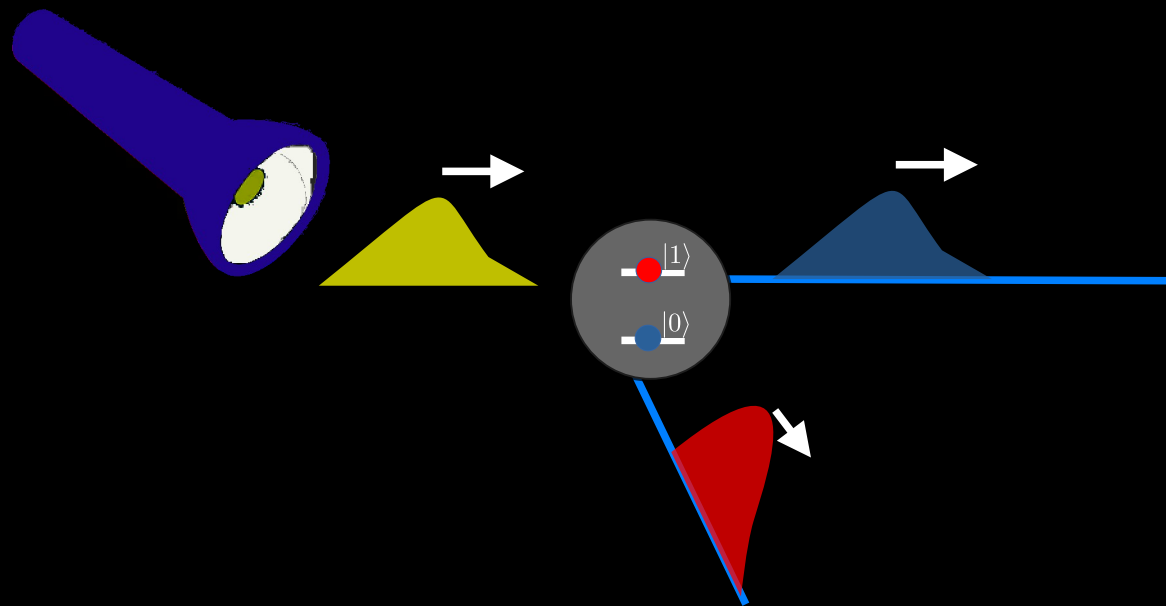

Modulated longitudinal coupling

$$g_z(t) = \bar{g}_z + \tilde{g}_z(t) \cos(\omega_c t)$$

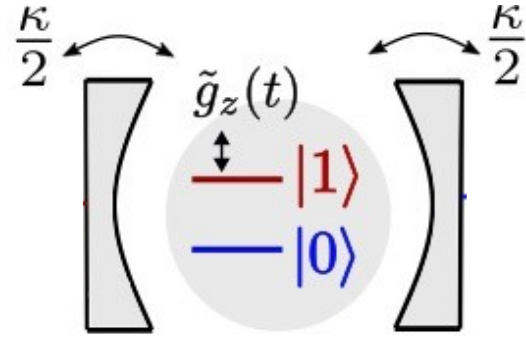

Rotating frame:

$$H(t) = i\tilde{g}_z(t) |1\rangle \langle 1| (a - a^\dagger)$$

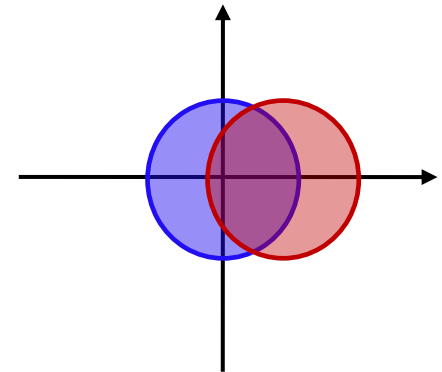

$$\langle r_{\text{in}} \rangle_t = \alpha_0 u(t)$$

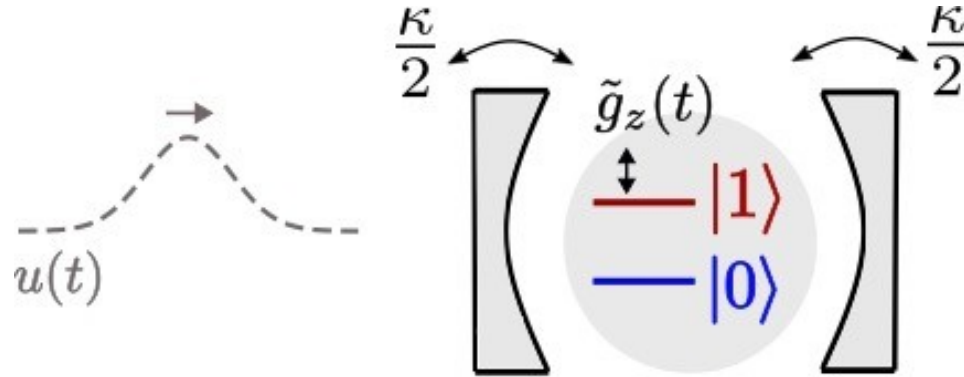

Quantum Langevin equation:

$$\langle \dot{a} \rangle_t = -\frac{\kappa}{2} \langle a \rangle_t + \tilde{g}_z(t) s - \sqrt{\frac{\kappa}{2}} \alpha_0 u(t)$$

$s = 0, 1$ (qubit state)

A which-path entangler

Qubit-state-conditioned transmission: $\tilde{g}_z(t) \propto \alpha_0 u(t)$

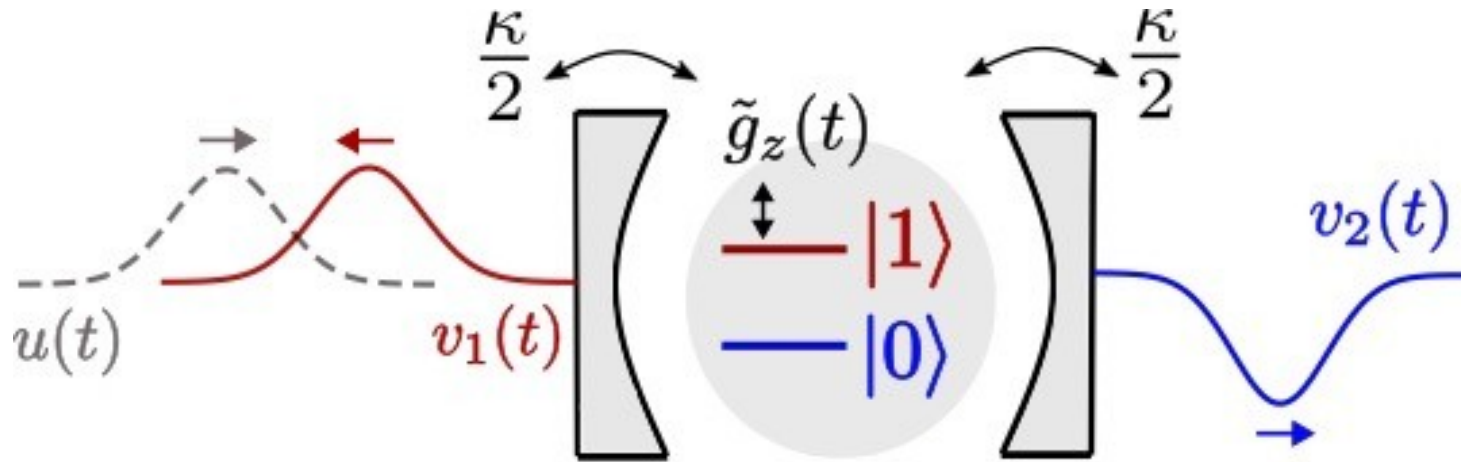

Qubit—Which-Path state $\rightarrow |\text{QWP}\rangle = \frac{1}{\sqrt{2}} (|1\rangle |\alpha, 0\rangle + |0\rangle |0, \alpha\rangle)$

Re-encoding the which-path qubit

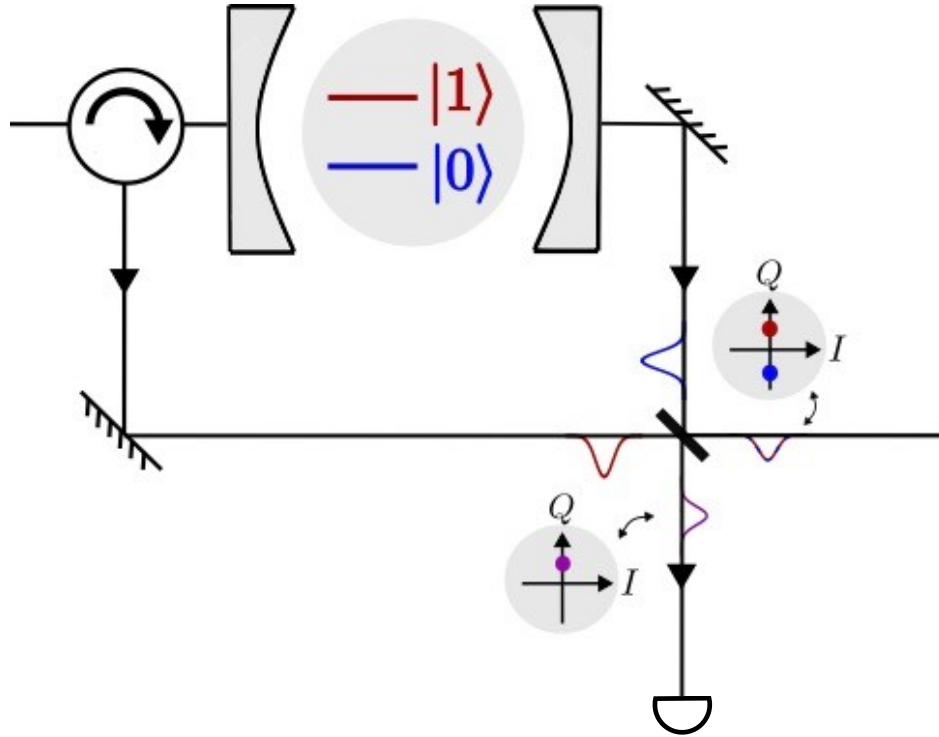

Post-measurement state:

$$|\Psi\rangle = \frac{1}{2} \sum_{\lambda=\pm} N_{\lambda} |\lambda, C_{\lambda}\rangle$$

“Flying” cat states: 

$$|C_{\pm}\rangle = \frac{1}{N_{\pm}} (|+\alpha\rangle \pm |-\alpha\rangle)$$

Distributed Bell/GHZ states

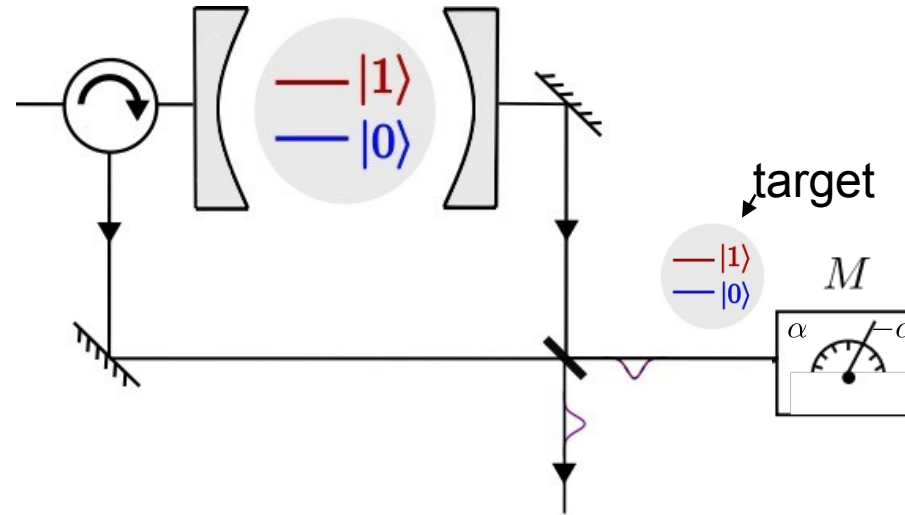

Measure: $|\pm\alpha\rangle \Rightarrow |\Psi_{\text{Bell}}\rangle = \frac{1}{2} (|++\rangle \pm |--\rangle)$

Entanglement: two-qubit concurrence

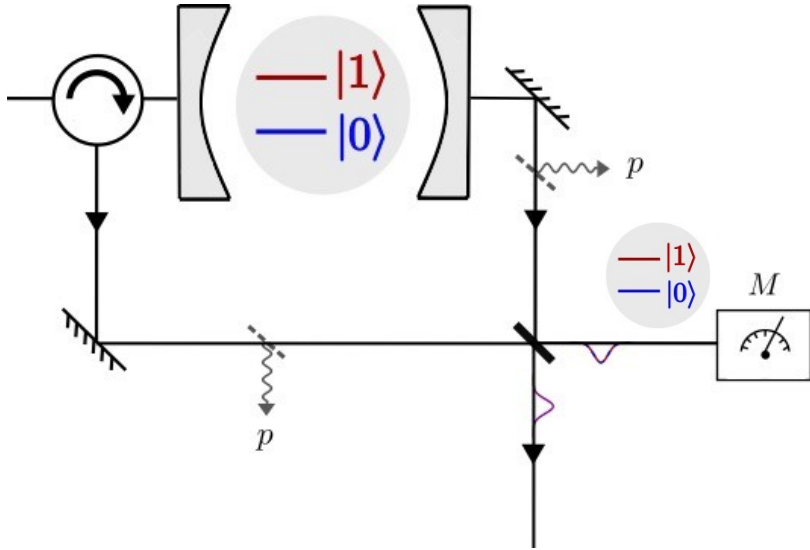

$$C = \max \left\{ 0, \operatorname{erf} \left(\sqrt{N_{\text{det}}} \right) e^{-N_{\text{lost}}} - \operatorname{erfc} \left(\sqrt{N_{\text{det}}} \right) \right\}$$

$$N_{\text{det}} = p(1 - p)|\alpha|^2$$

$$N_{\text{lost}} = p|\alpha|^2$$

Precision sensing/interferometry?

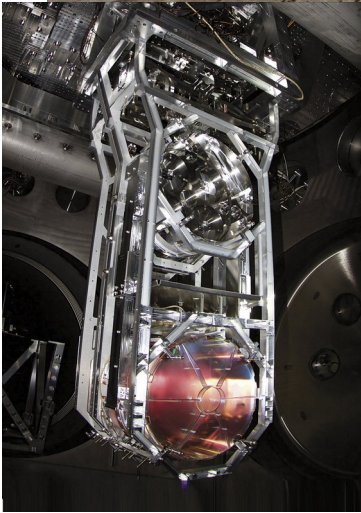

<https://www.ligo.caltech.edu/news/ligo20231023>

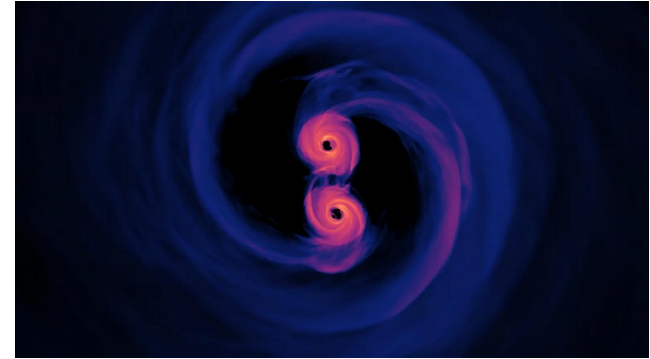

<https://bigthink.com/starts-with-a-bang/merging-supermassive-black-holes/>



OCT Eye Test - Optical Coherence Tomography

www.drswatisattheeyeclinic.com

Precision phase measurements with path-entangled states

$$|\text{ECS}\rangle = \mathcal{N}_\alpha (|\alpha, 0\rangle + |0, \alpha\rangle)$$

$$|\text{QWP}\rangle = \frac{1}{\sqrt{2}} (|\uparrow, \alpha, 0\rangle + |\downarrow, 0, \alpha\rangle)$$

$$\phi = \phi_1 - \phi_2 = ?$$

Quantum Cramér-Rao bound:

$$\delta\phi_{\min} = \frac{1}{\sqrt{MI_Q(\rho_\phi)}}$$

$$\rho_\phi = U_\phi \rho(0) U_\phi^\dagger, \quad U_\phi = \prod_{i=1,2} e^{-i\phi_i n_i}$$

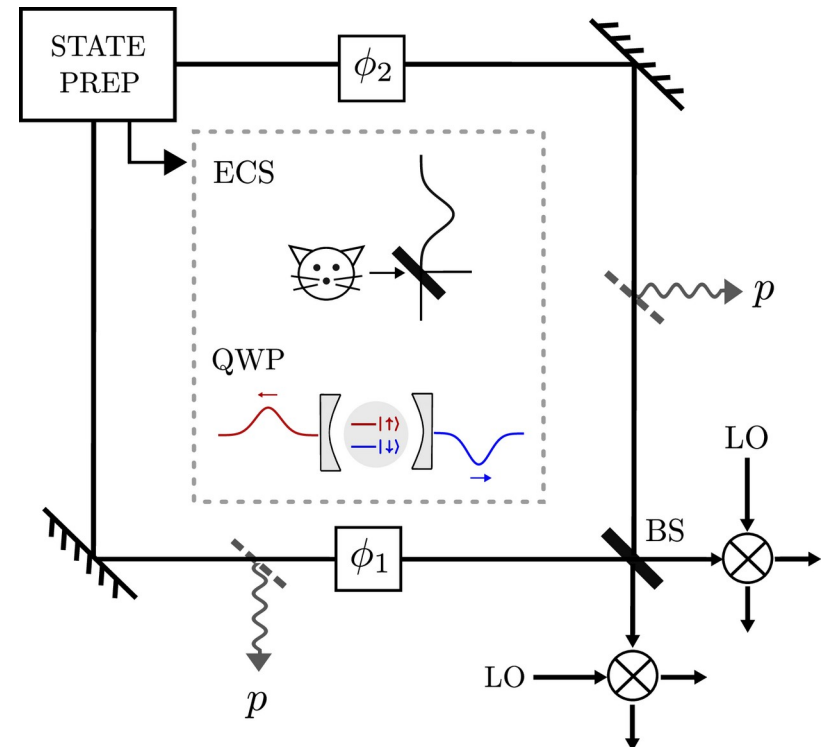

$$I_Q(|\alpha\rangle_\phi) = \bar{n} \longrightarrow \delta\phi_{\min} \sim \frac{1}{\sqrt{\bar{n}}} \quad \text{SQL (shot noise)}$$

$$I_Q(|N00N\rangle_\phi) = N^2 \longrightarrow \delta\phi_{\min} \sim \frac{1}{N} \quad \text{Heisenberg}$$

$$I_Q(|\text{ECS}\rangle_\phi) = \bar{n}^2 + \bar{n} + O(\bar{n}^2 e^{-\bar{n}})$$

$$I_Q(|\text{QWP}\rangle_\phi) = \bar{n}^2 + \bar{n}$$

Heisenberg SQL (shot noise)

Optimal measurements

Classical Cramér-Rao bound:
$$\delta\phi = \frac{1}{\sqrt{M I_C(\phi)}}$$

$$I_C(\phi) = \int dx (\partial_\phi \ln p(x|\phi))^2 p(x|\phi)$$

$$p(x|\phi) = \text{Tr}\{\hat{\Pi}_x \rho_\phi\}$$

$$I_C(\phi) = I_Q(\rho_\phi)$$

$$\delta\phi = \delta\phi_{\min}$$

e.g. photon counting [Hofman, PRA (2009)]

An optimal homodyning scheme

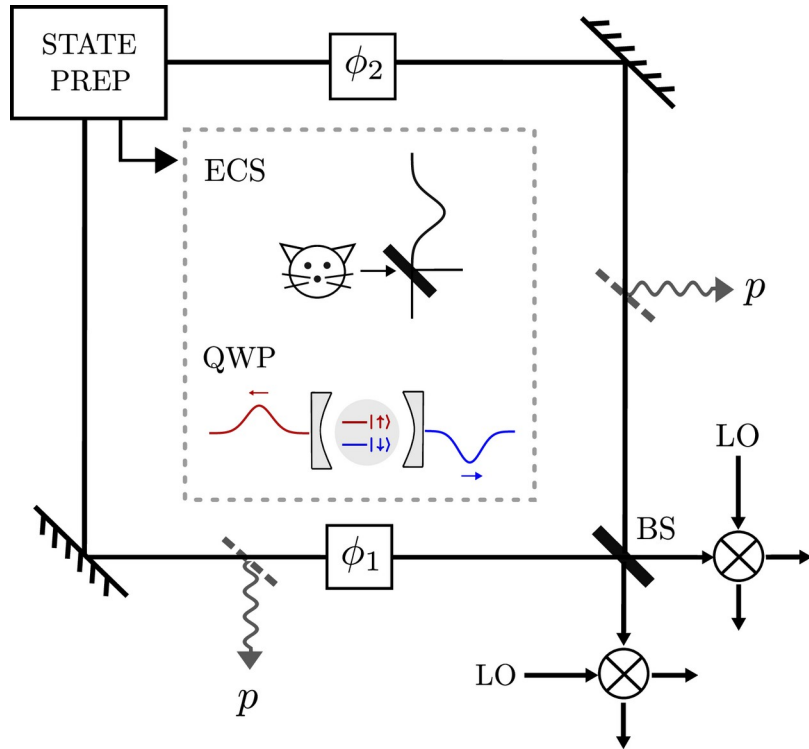

$$\varphi_+ = \frac{\pi}{2} + \bar{\phi} \quad \bar{\phi} = \frac{1}{2}(\phi_1 + \phi_2)$$

$$\varphi_- = \bar{\phi}$$

+ X-basis readout for QWP

$$\hat{\Pi}_x = |X\rangle\langle X| \bigotimes_{\sigma=\pm} |x_{\varphi_\sigma}\rangle\langle x_{\varphi_\sigma}|$$

$$I_C(\phi) = I_Q(\rho_\phi)$$



Heisenberg scaling is due to phase-space interference

$$|\widetilde{\text{ECS}}_\phi\rangle = \mathcal{N}_\alpha (|\alpha_{\phi_1}, \alpha_{\phi_1}\rangle + |-\alpha_{\phi_2}, \alpha_{\phi_2}\rangle)$$

$$|\widetilde{\text{QWP}}_\phi\rangle = \frac{1}{\sqrt{2}} (|\uparrow, \alpha_{\phi_1}, \alpha_{\phi_1}\rangle + |\downarrow, -\alpha_{\phi_2}, \alpha_{\phi_2}\rangle)$$

$$\alpha_{\phi_j} = e^{i\phi_j} \frac{\alpha}{\sqrt{2}}$$

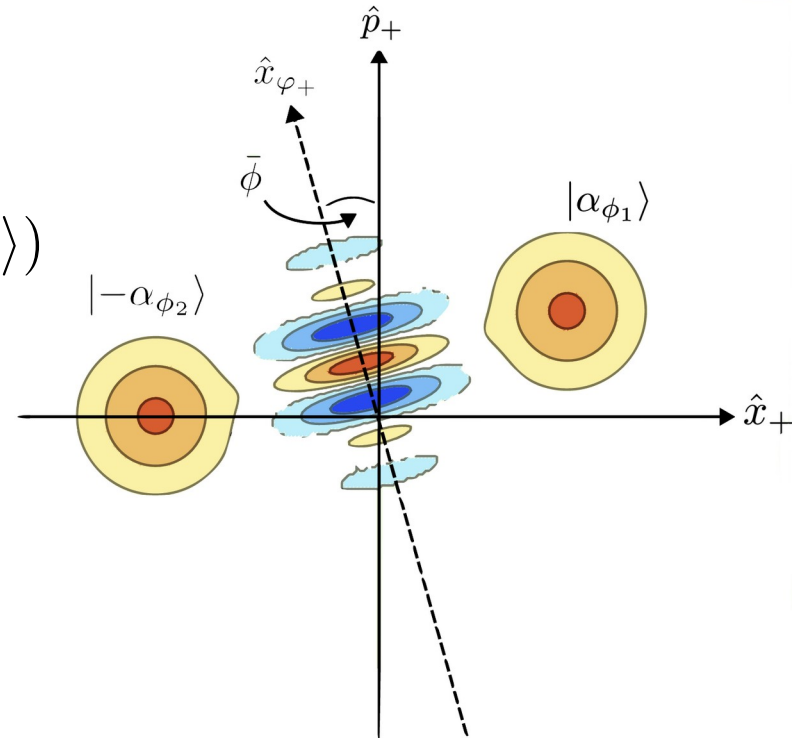

No prior knowledge of ϕ required

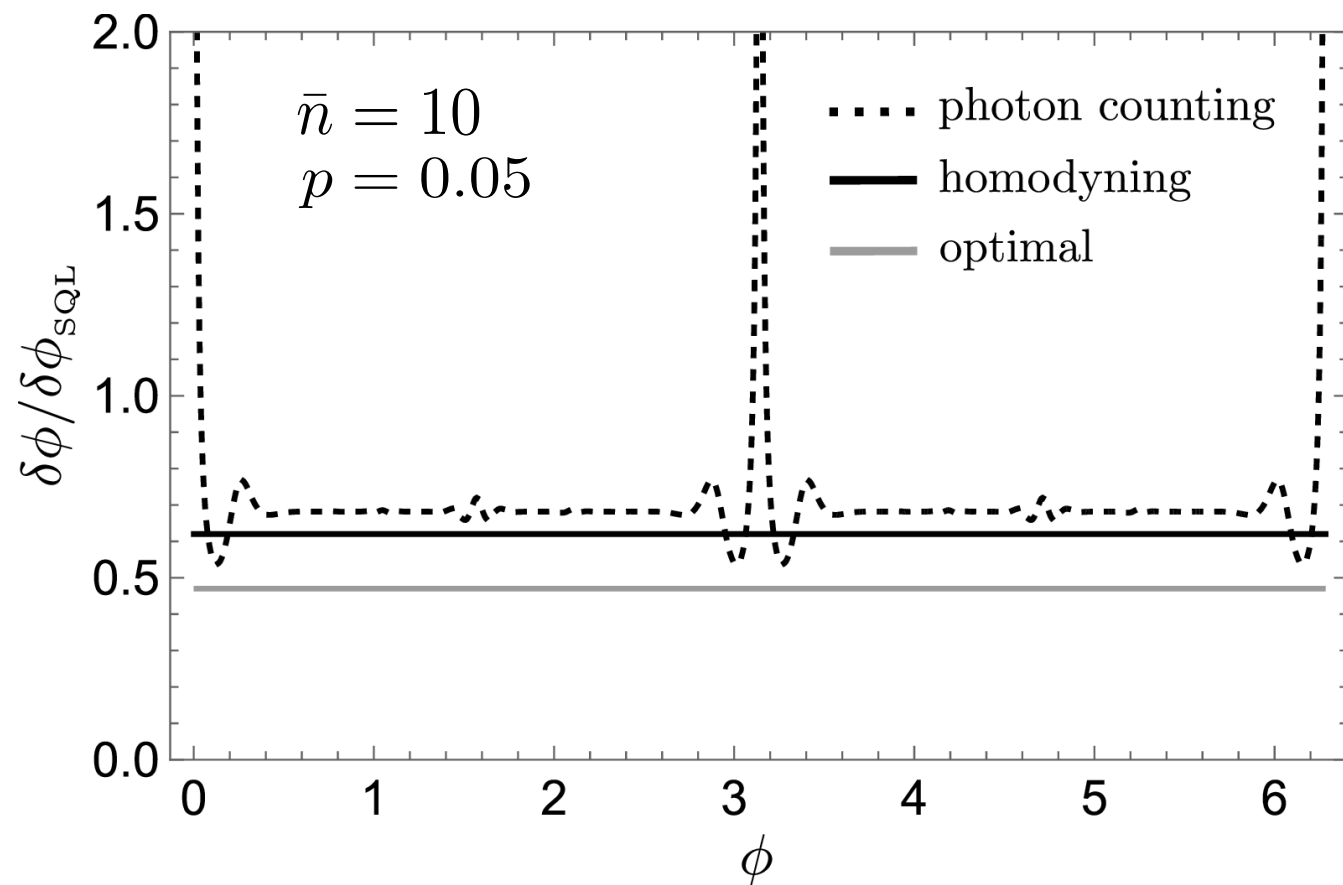

Thanks: Group/Collaborators



Zoé McIntyre PhD

PhDs

Valentin Boettcher
Felix Fehse
Iván Martínez
Zoé McIntyre

MSc

Noah Pinkney

Collaborators

McGill

Tami Pereg-Barnea
Kai Wang

Sherbrooke

Michel Pioro-Ladrière
Alexandre Blais

Université de Montréal

Philippe St-Jean
Félix Pellerin

University of Waterloo

Christine Muschik
Pooya Ronagh