

Neutron Spectroscopy

UK Nuclear Physics Summer School 2024

Dr Chantal Shand CPhys

Applied Radiation Technology Group Leader

chantal.shand@ukaea.uk

Introduction

- PhD Experimental Nuclear Physics – University of Brighton
 - Attended this Summer school in 2015
- Started a role at UKAEA as an analyst in 2017
 - Became responsible for the radiometric lab
 - Started building a group of radiometric analysts
 - Grew my portfolio of work in fusion
 - Became group leader in 2023

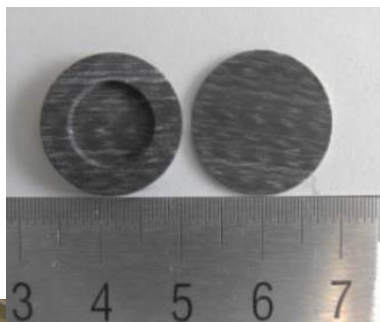
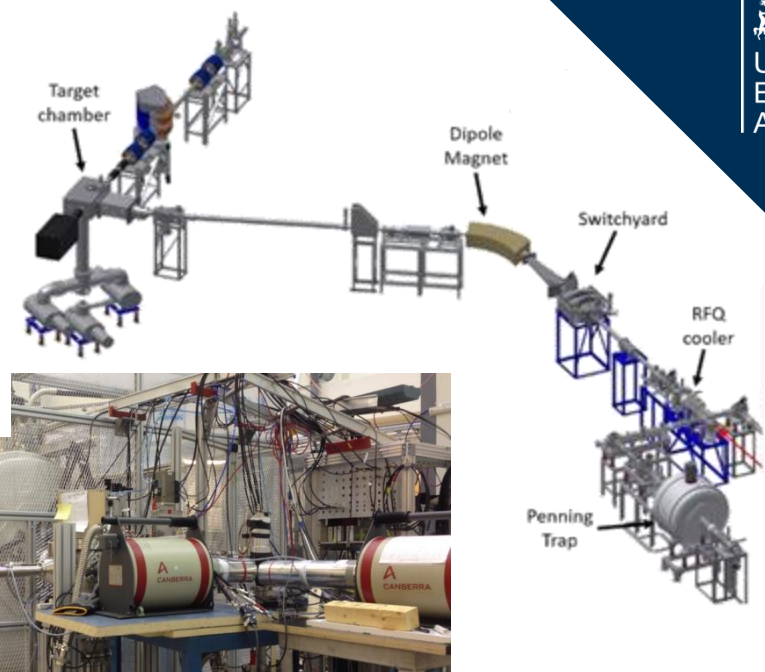
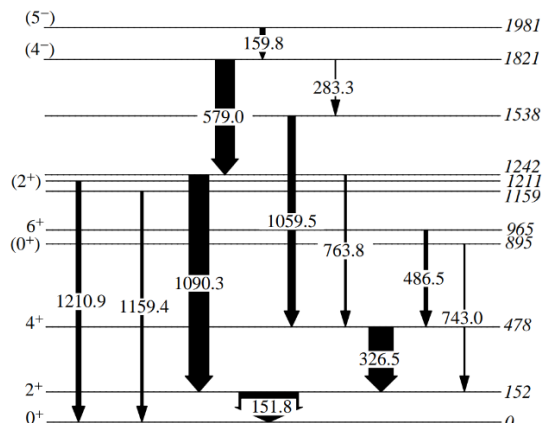

Neutron Spectrum Unfolding for the Development of a Novel Neutron Detector for Fusion

C.R. Nobs^{a*}, L.W. Packer^a, P. Batistoni^b, B. Colling^a, Z. Ghani^a, M. R. Gilbert^a, S. Loreti^b, K. Mergia^c, S. Messoloras^c, I. Michelakaki^c, M. Pillon^b, M. I. Savva^c, I. E. Stamatelatos^c, K. Triantou^c, T. Vasilopoulou^c

^aCulham Centre for Fusion Energy, Science Centre, Abingdon, Oxon, OX14 3DB, UK

^bENEA - Department of Fusion and Technology for Nuclear Safety and Security via E. Fermi 45, 00044 Frascati (Rome), Italy

^cInstitute of Nuclear & Radiological Sciences and Technology, Energy & Safety, NCSR Demokritos, Athens, 15310, Greece

Abstract

In future fusion power plants, such as DEMO, the D-T neutron emission rate is predicted to exceed $1 \times 10^{21} \text{ n s}^{-1}$. Accurately monitoring neutron energies and intensities will be the primary method for estimating fusion power, and calculating key nuclear parameters, including the tritium breeding ratio and nuclear heating. The Novel Neutron Detector for Fusion (VERDI) project, implemented under the EUROfusion Enabling Research 2017 program, aims to develop a detector capable of withstanding the harsh environment of a future fusion power plant. The VERDI detector is based on the foil activation technique, which relies on neutron spectrum unfolding methods to process the convolution of gamma-ray measurement and detector response function to infer the neutron energy spectrum. This paper details the experimental method and results collected using six prototype VERDI detectors during an initial experiment performed in July 2017 at the ENEA Frascati Neutron Generator (FNG) under D-T neutrons (14 MeV). The measured activities of product isotopes are compared with equivalent data calculated using the FISPACT-II code to provide an average C/E_{act} agreement of 1.05 ± 0.13 . Experimental results from the FNG have been applied to neutron spectrum unfolding techniques using established unfolding codes, MAXED and GRAVEL.

Keywords: neutronics, neutron detector, FNG, unfolding, neutron activation

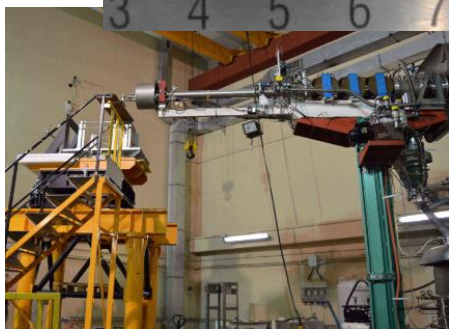

Day 1:

- Introduction to Fusion**
- Neutron Diagnostics on Current Machines**

The world needs energy

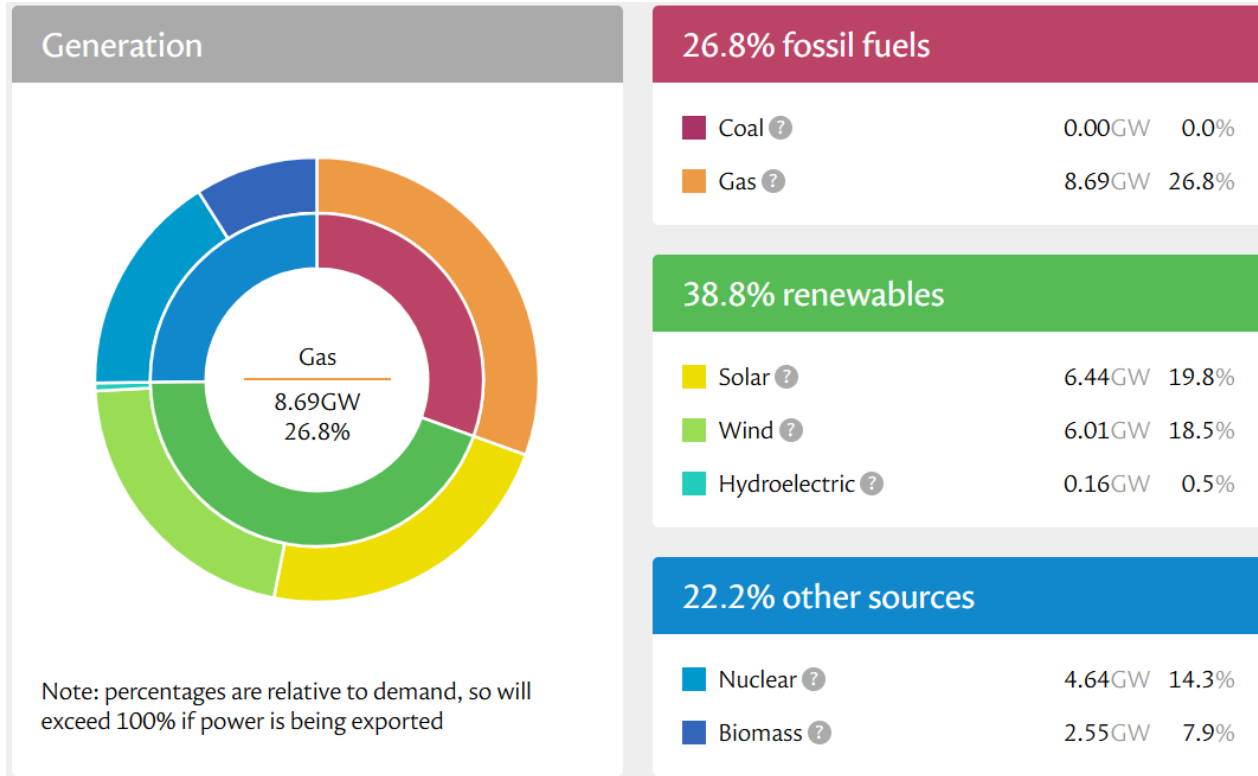

26.8% fossil fuels

Coal ?	0.00GW	0.0%
Gas ?	8.69GW	26.8%

38.8% renewables

Solar ?	6.44GW	19.8%
Wind ?	6.01GW	18.5%
Hydroelectric ?	0.16GW	0.5%

22.2% other sources

Nuclear ?	4.64GW	14.3%
Biomass ?	2.55GW	7.9%

Source: <https://grid.iamkate.com/>
Accessed: 29th July 2024

- The world uses a lot of energy and as populations increase and technologies develop so does energy consumption
- How to manage a shift from fossil fuels to low carbon sources?
- How will we meet baseload power requirements of the future?
- ‘Net Zero’ by 2050?

Nuclear reactions

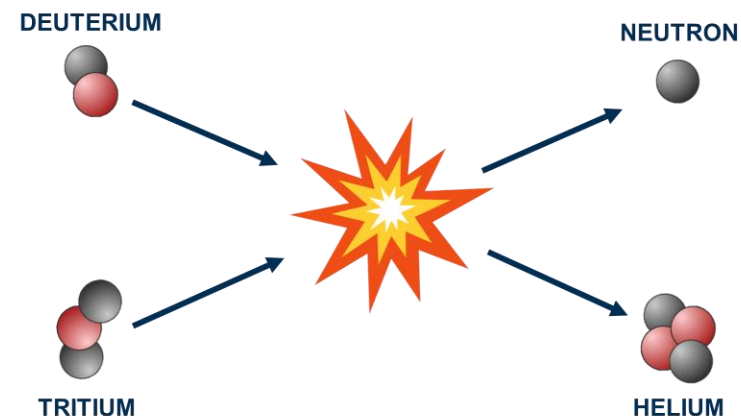
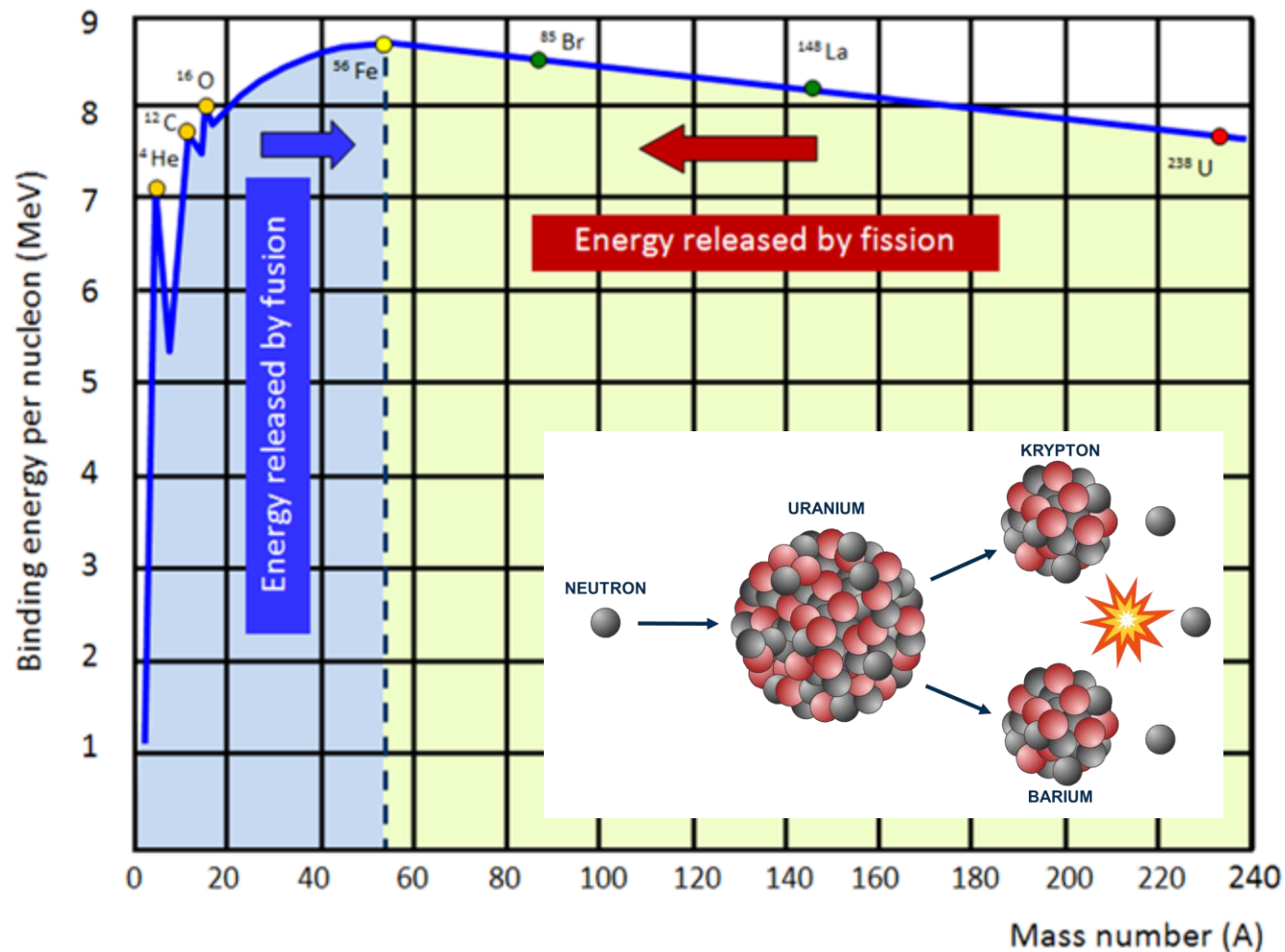

Energy per mole from the DT reaction

Molar masses:

D ~2.013g, T ~3.016g; He-4 ~4.0026g, n ~1.0087g

Mass difference:

$$\Delta m = m_{\text{D}} + m_{\text{T}} - m_{\text{He}} - m_{\text{n}} \sim 0.018 \text{ g per mole}$$

$$\text{Energy} = (\Delta m)c^2 = 1.6 \times 10^{12} \text{ J per mole}$$

Average energy usage in the EU for 1 person ~ 20kWh/day:
5g of fuel ~ 63 years of energy for one person!

Energy per kg - DT fusion is a factor of between 10 and 14 million times that of coal depending on coal sources

Nuclear fusion in stars

p-p chain

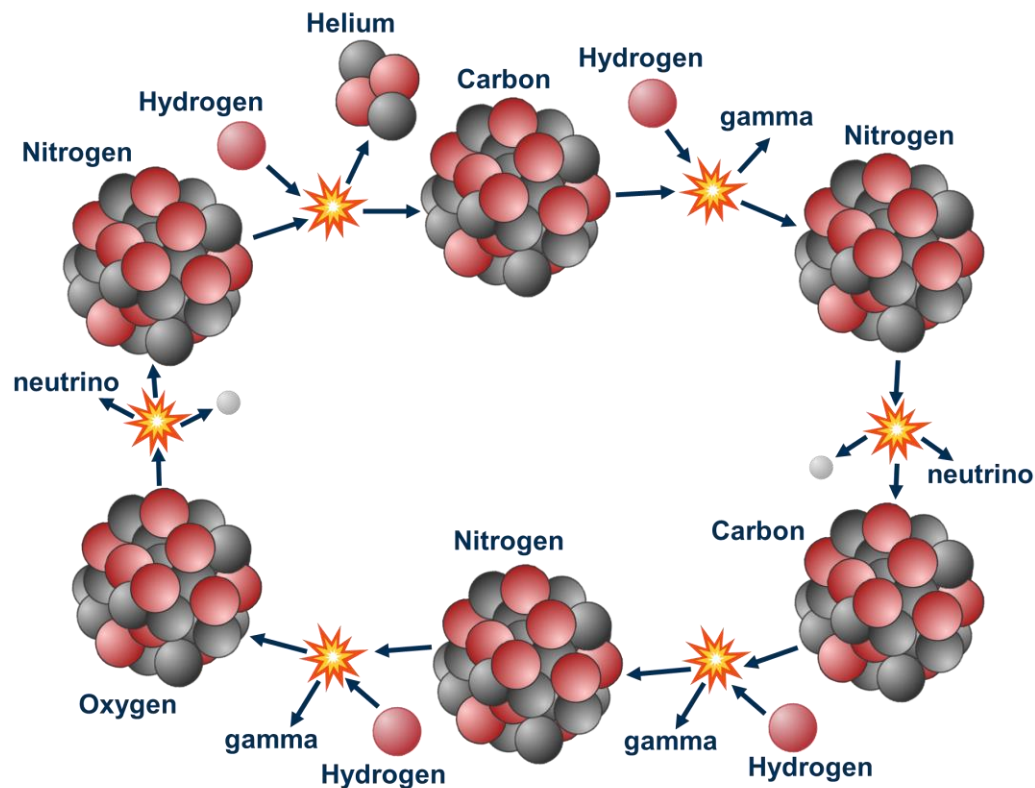
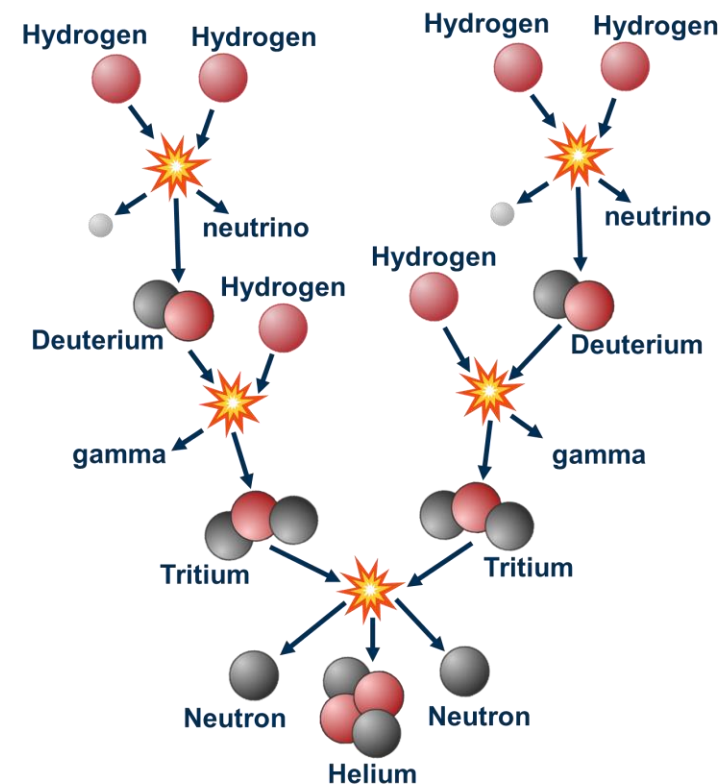

CNO cycle

Nuclear fusion on Earth

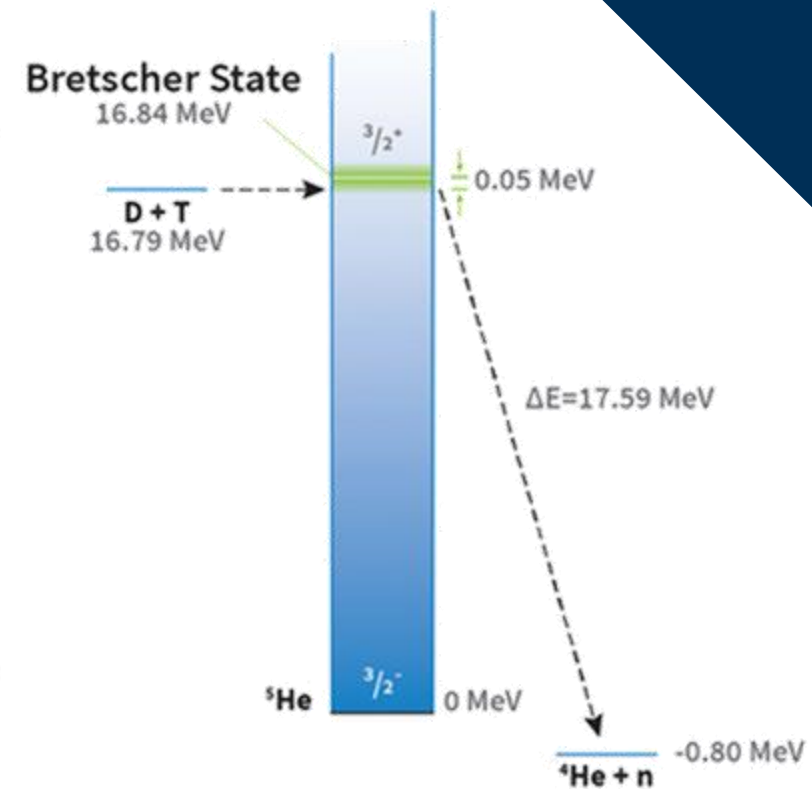
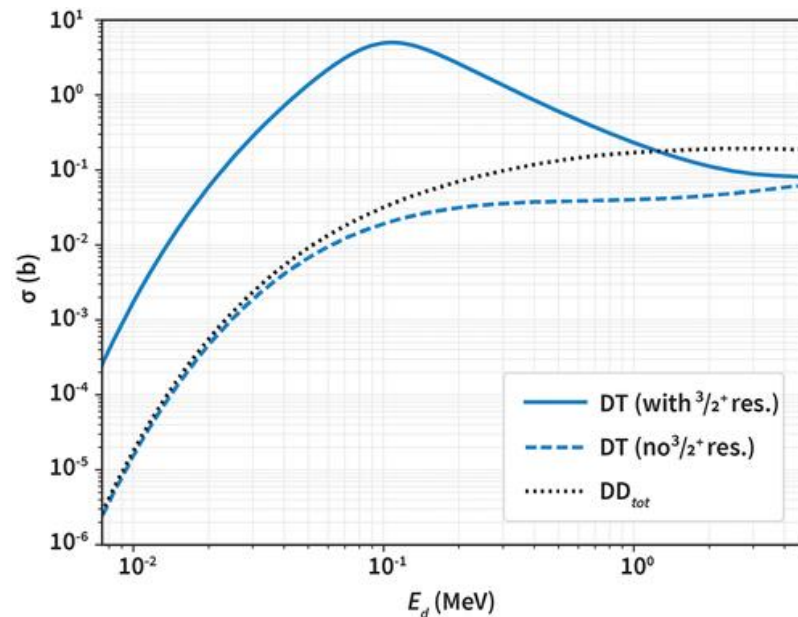
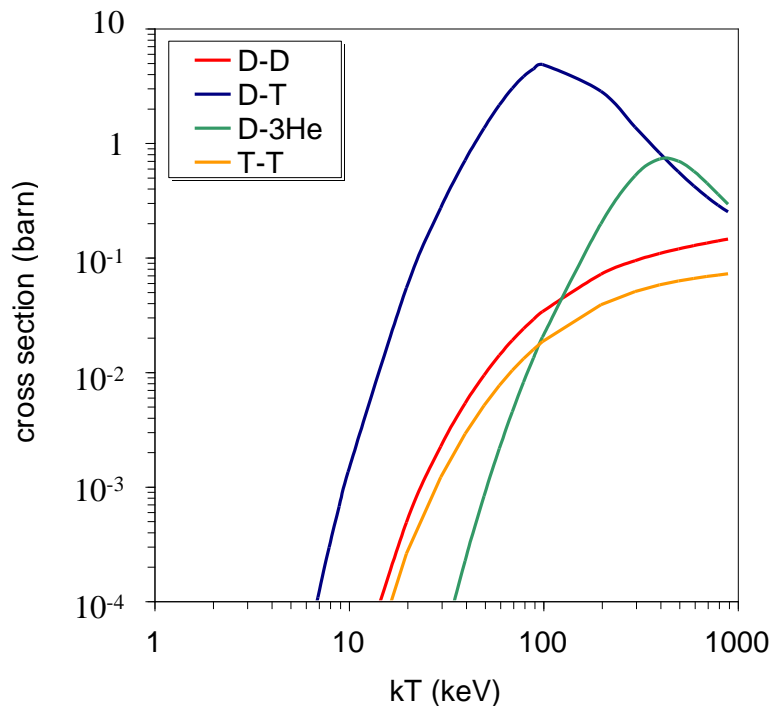

DT fusion cross section exceeds the deuterium-deuterium (DD) cross sections by a factor of 100, thanks to the $A=5$ $J^\pi 3/2^+$ “**Bertscher**” state

Benefits of fusion



Less Radiotoxic Waste than Fission

Only structural material becomes radioactive in fusion

High Fuel Efficiency

Fusion produces more energy per gram of fuel than any other process that could be achieved on Earth

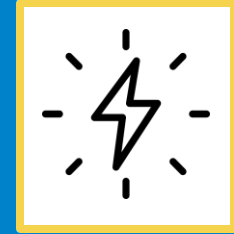

No CO₂

The only waste products are small amounts of helium



Safe

There is no risk of a runaway reaction with fusion

Continuous Supply

Fusion will provide reliable power and costs are predicted to be similar to other energy sources.



Abundant Fuels

Deuterium can be extracted from water and tritium will be produced inside the reactor

Challenges of Fusion

- Requires investment, political will, and skilled, dedicated scientists and engineers to solve technological and materials problems
- Fusion is not a silver bullet – going to need fission and renewables in the mix
- Fusion is moving from the research phase to the delivery phase. Key technologies and materials needed for power plants have not yet been fully tested and demonstrated



Several Approaches to Fusion

Inertial Confinement

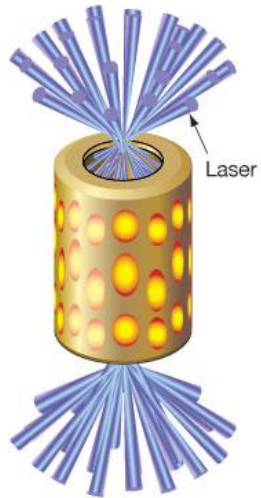

Gravitational Confinement

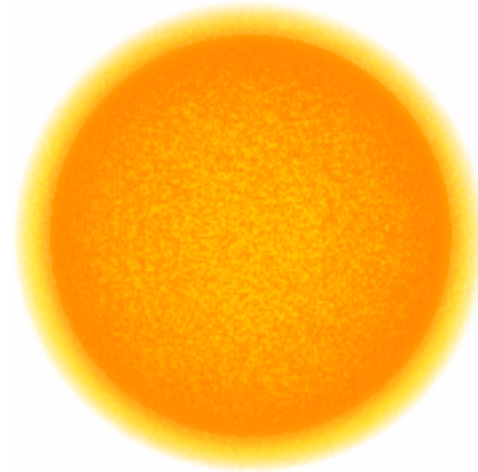

Magnetic Confinement



Joint European Torus (JET)

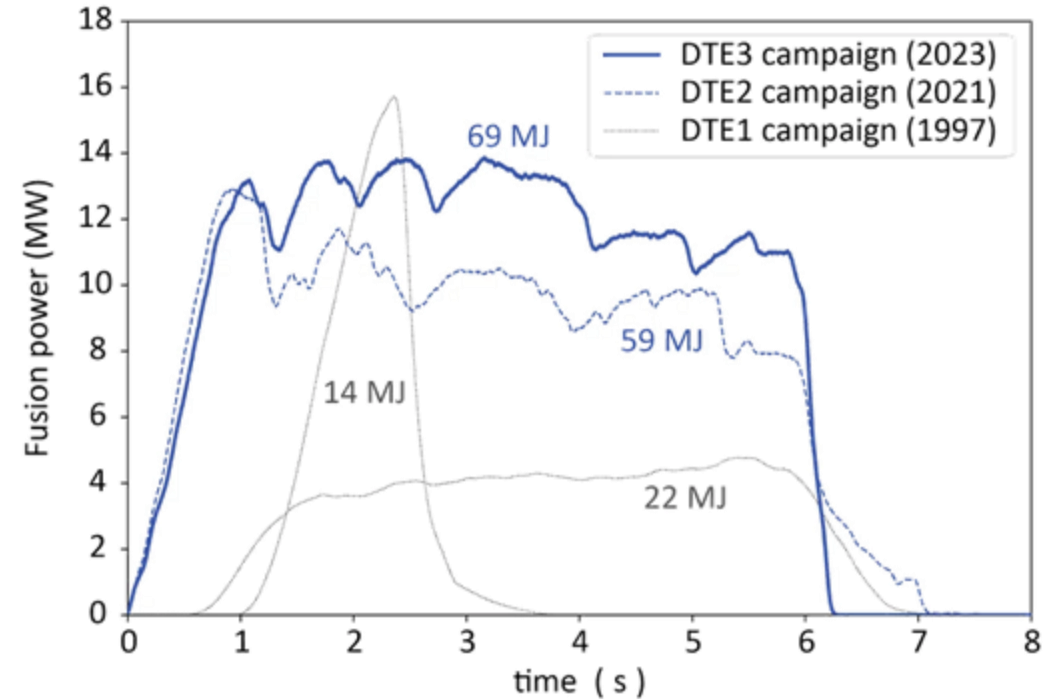
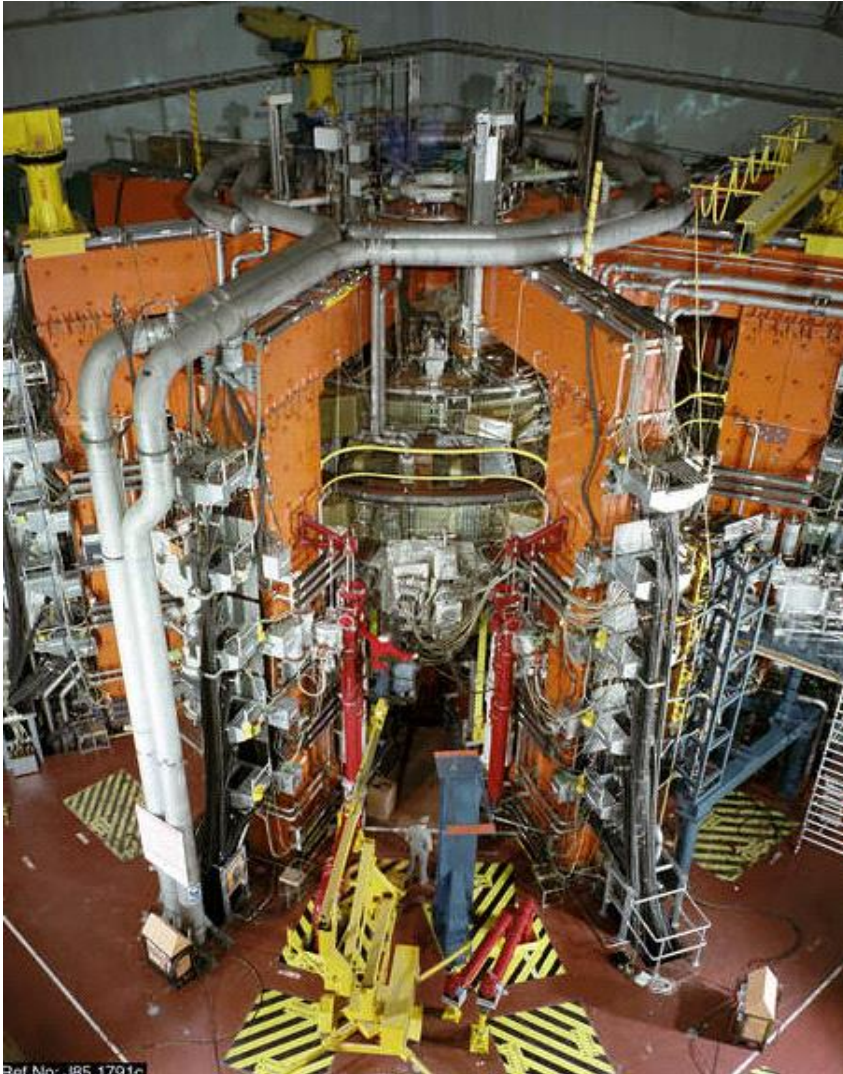

JET has achieved the largest amount of energy ever achieved in a fusion experiment – using just 0.2 milligrams of fuel.



The Triple Product (Lawson Criterion)

TEMPERATURE (T)

Up to 10 times hotter than the Sun's core
150 million °C

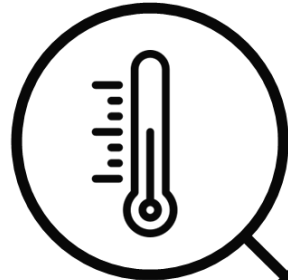

It compares the rate of energy being generated by fusion reactions within the fusion fuel to the rate of energy losses to the environment.

DENSITY (n)

1 million times less dense than the air we breathe

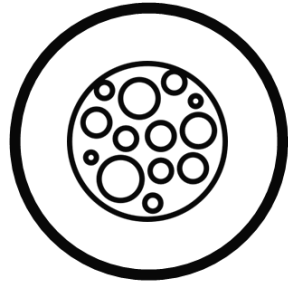

16 MW PLASMA POWER

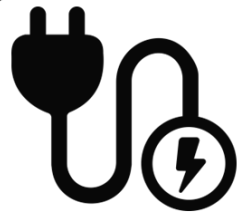

CONFINEMENT TIME (τ_E)

Currently on the order of 1 second

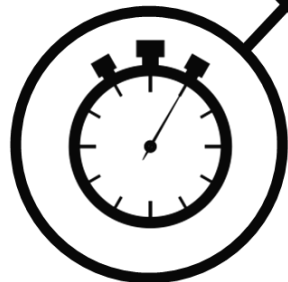

Conditions required for ignition:

$$n\tau_E \geq \frac{12kT}{\langle \sigma v \rangle \epsilon_\alpha}$$

$$P_{\text{fus}} = n_D n_T \langle \sigma v \rangle \epsilon_\alpha V$$

Reactivity: depends on temperature

Density of D and T

Energy of alpha

Volume

High temperature to give nuclei the energy to overcome electrostatic repulsion, but too high and the nuclei are not near each other for long enough for fusion to occur.

High density increases the chance for reactions to occur, but too high and collisions instead take place between nuclei and electrons (Bremsstrahlung).

The time the plasma is maintained at a temperature above the critical ignition temperature.

Heating Mechanisms

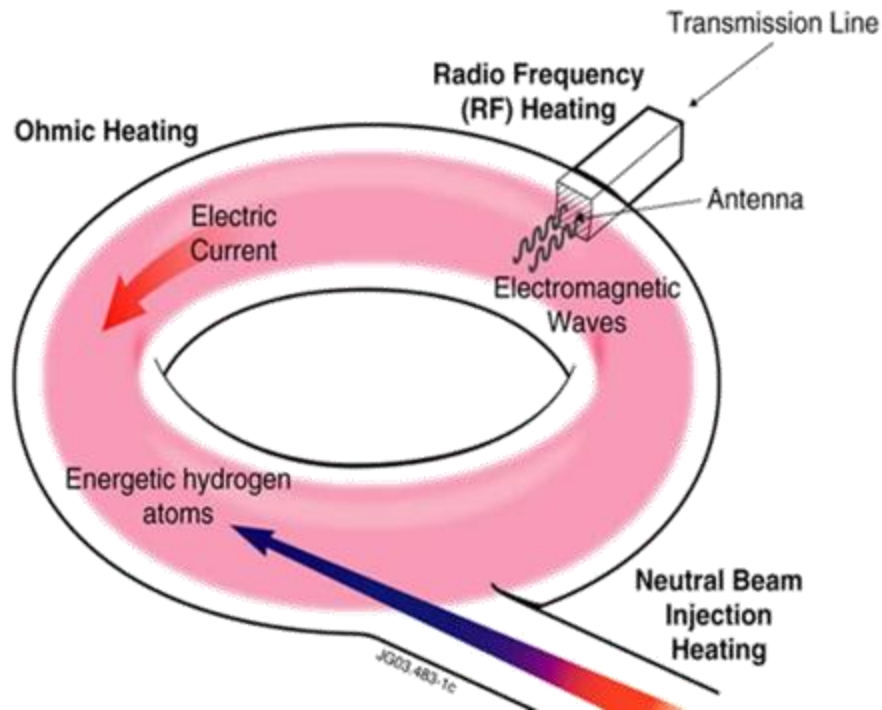

Ohmic (resistive) heating (reaching about 10 million °C):

The plasma is an electrical conductor, so the magnetic fields induce an electrical current which travels through the plasma. Electrons and ions become energized and collide creating "resistance" that results in heat. Ohmic heating becomes increasingly ineffective at high temperatures.

Radio Frequency (RF) heating:

Inject high power radiofrequency waves and microwaves into the plasma

Neutral Beam Injection (NBI) heating:

D⁺ or T⁺ ions are accelerated by a magnetic field, a "neutralizer" rips them of their electrical charges, allowing them to penetrate the tokamak's magnetic cage and enter the plasma where they deposit energy through collisions.

Burning plasma

A plasma in which the heat from the fusion reactions is confined within the plasma efficiently enough for the self-heating effect to dominate any other form of heating and external heating methods can be strongly reduced. It is hoped this will be demonstrated in ITER.

Divertor



- Even if perfect confinement ($\tau \rightarrow \infty$), plasma loses energy by radiation in 3 ways:
 - bremsstrahlung: $P \sim nZ^2$ - collisions of electrons and ions
 - synchrotron (cyclotron): $P \sim nZ$ - electrons spiralling around magnetic field lines
 - line emission: $P \sim (nZ)^2$ - electrons bound to impurity ions that are not fully ionised
- Therefore, crucial to keep low impurity levels also with low Z

Mega Amp Spherical Tokamak Upgrade (MAST-U)

Plasma science machine addressing key physics issues for ITER, primarily the plasma exhaust system – trialling the Super-X configuration.

Differs from JET which is a conventional tokamak. The spherical tokamak has excellent potential for compact test reactors and smaller cheaper power plants.

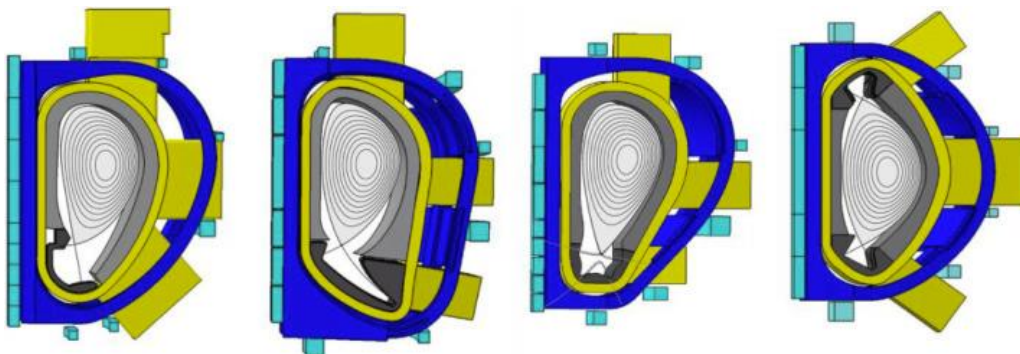

X

Super X

Snowflake

Double null

Neutron spectra in tokamaks

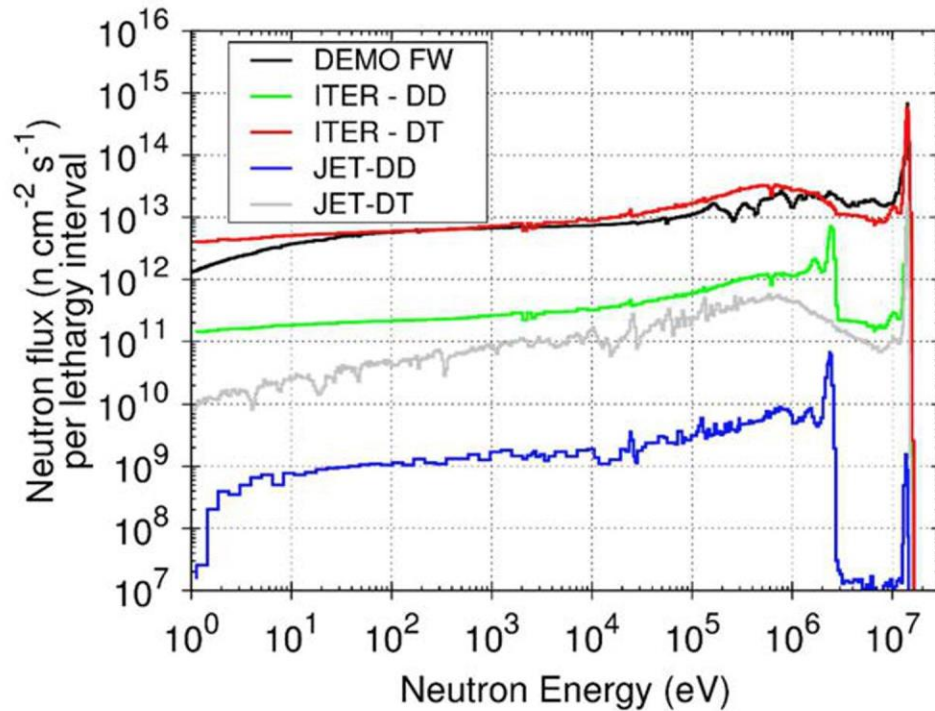

- The plasma will produce monoenergetic neutrons either 14 MeV (DT) or 2.5 MeV (DD)
- 14 MeV fusion neutrons lose energy by elastic and inelastic scattering events with material in the device surrounding the plasma
- Hence even at the first wall there will be a large range of neutron energies

- Measurement of neutrons directly relates to fusion power
- Plasma and fuel parameters can be derived from neutrons
 - fuel ratio (n_T/n_D)
 - fast ion temperature and alpha energy distribution
 - alpha particle density profile
 - fast ion related MHD instabilities

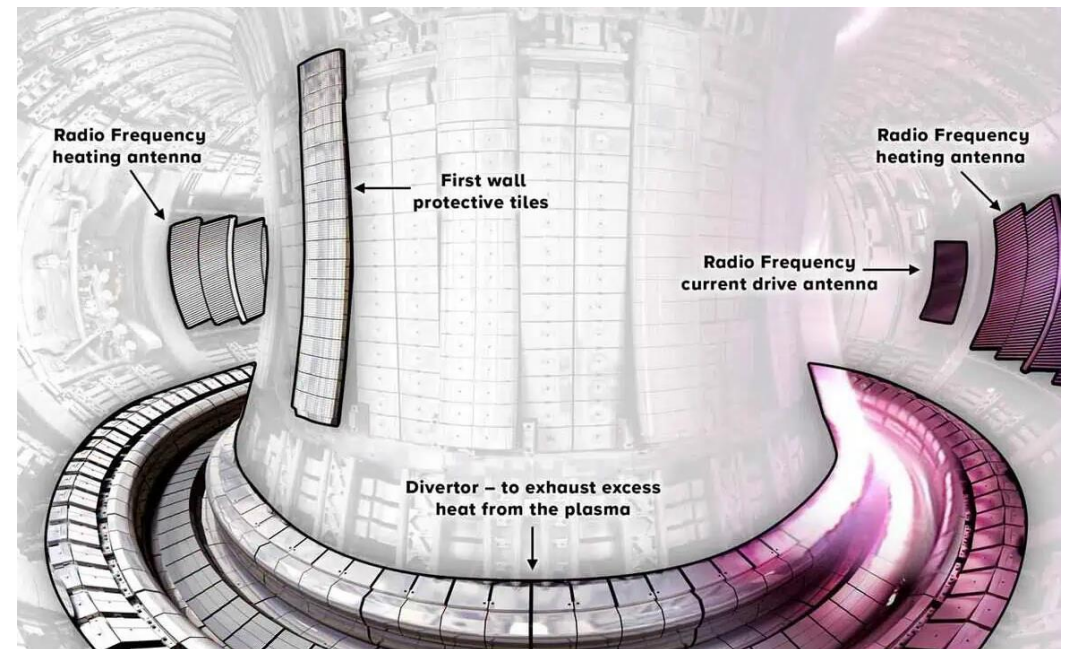

14 MeV neutron spectrometer

Magnetic Proton Recoil (MPR) spectrometer

Based on the principle of the proton recoil telescope, initially for 14 MeV neutrons.

- Collimated neutrons scatter elastically on hydrogen nuclei (protons) in a thin plastic foil
- The energy distribution of the ejected protons is measured in a semiconductor detector.
- The **neutron spectrum** can then be deduced from the proton spectrum, given knowledge of the geometry of the instrument.

Three identical telescope modules arranged one behind the other, to increase efficiency without worsening resolution.

- Horizontal line of sight to the plasma
- The detector is physically shielded

MPRu

To access 2.5MeV (DD) neutrons.

Each element of the hodoscope has a fast plastic scintillator facing the incoming protons as the top layer and a second thicker slow scintillator. The different timing properties makes pulse shape discrimination possible.

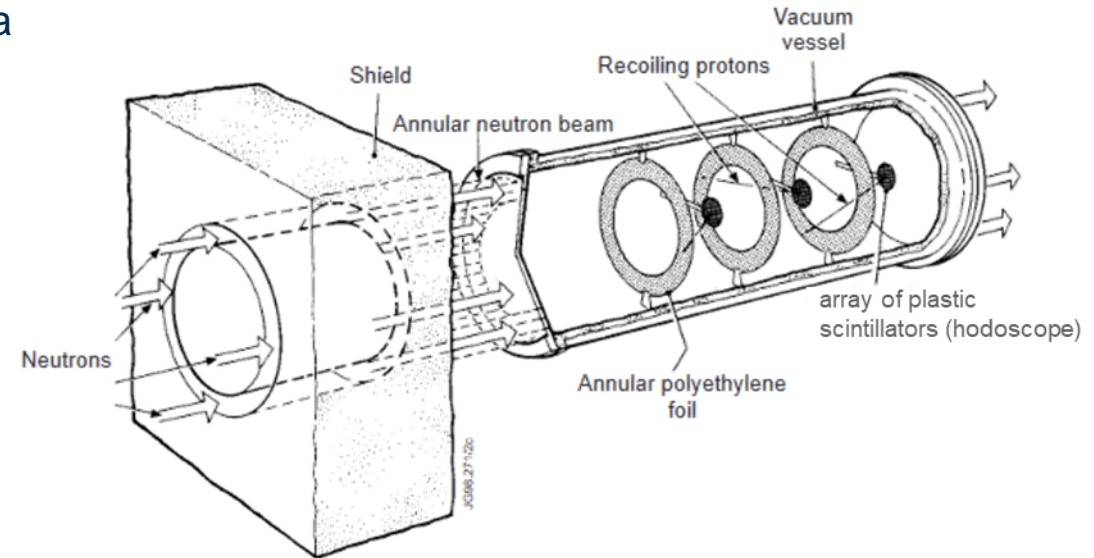
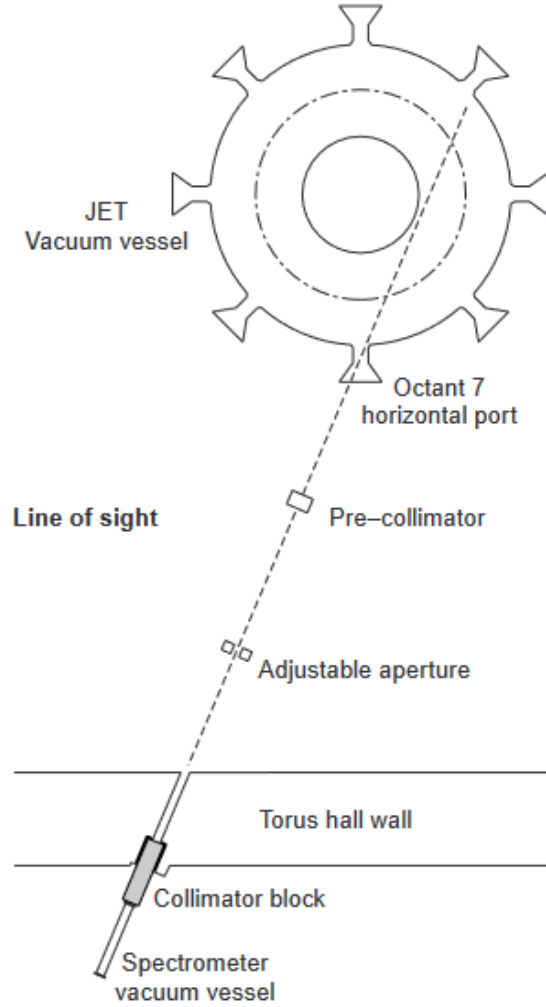

2.5 MeV Time-of-flight neutron spectrometer

Time Of Flight neutron spectrometer Optimized for high count Rate (TOFOR)

- Requires direct lines of sight to the plasma (vertical in JET)
- Neutrons leave the plasma through a vertical port through a collimator.
- Neutrons enter TOFOR through a small scintillation detector, where they scatter on hydrogen giving a signal in the first detector.
- The scattered neutron then travels to an upper detector array resembling an umbrella.
- The time between the first and the second pulse gives a measure of the **neutron energy**.

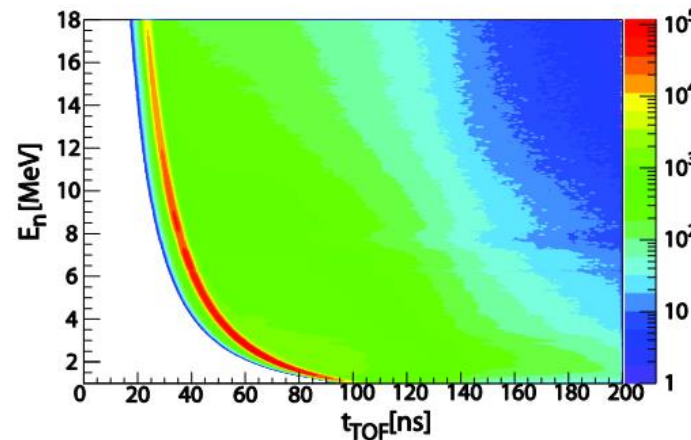
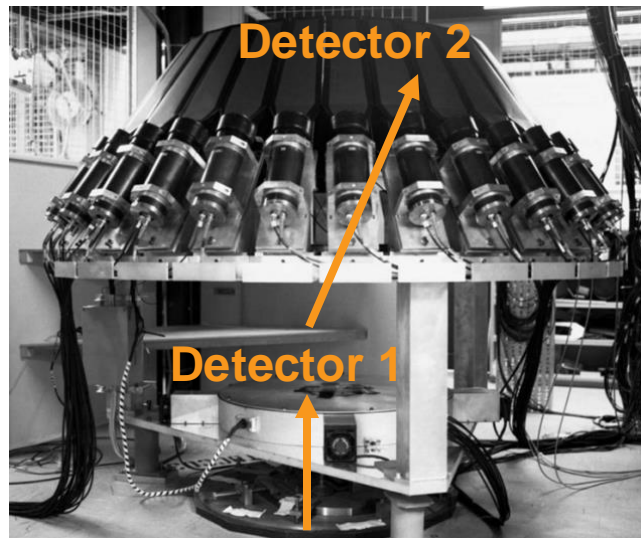

These devices are large, complex and manpower-intensive.

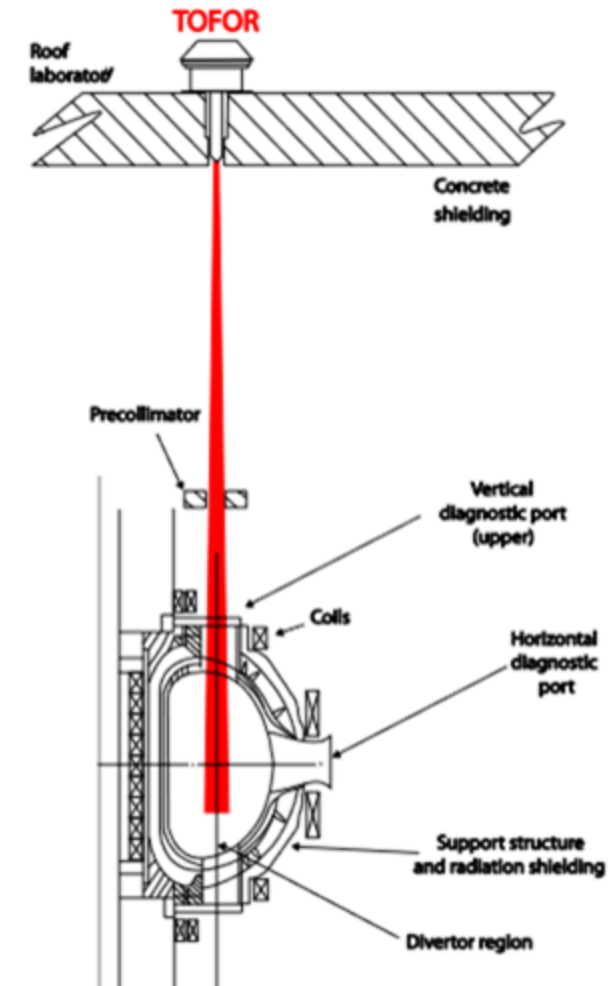

<https://scipub.euro-fusion.org/wp-content/uploads/2014/11/EFDC060101.pdf>

Neutron yield profile monitor

Requires direct lines of sight to provide neutron emission as a function of both position and time.

The neutron profile monitor consists of two concrete shields which each provides a fan-shaped array of collimators. There are two neutron detectors, NE213 liquid scintillators and BC418 plastic scintillators, pulse shape discrimination can be used to distinguish neutrons of different energies.

The ratio of the 2.5–14 MeV neutron yields provides a **measure of the ratio of the densities of deuterium and tritium in the plasma**. Used (1999) to study the transport of tritium into a magnetically confined plasma

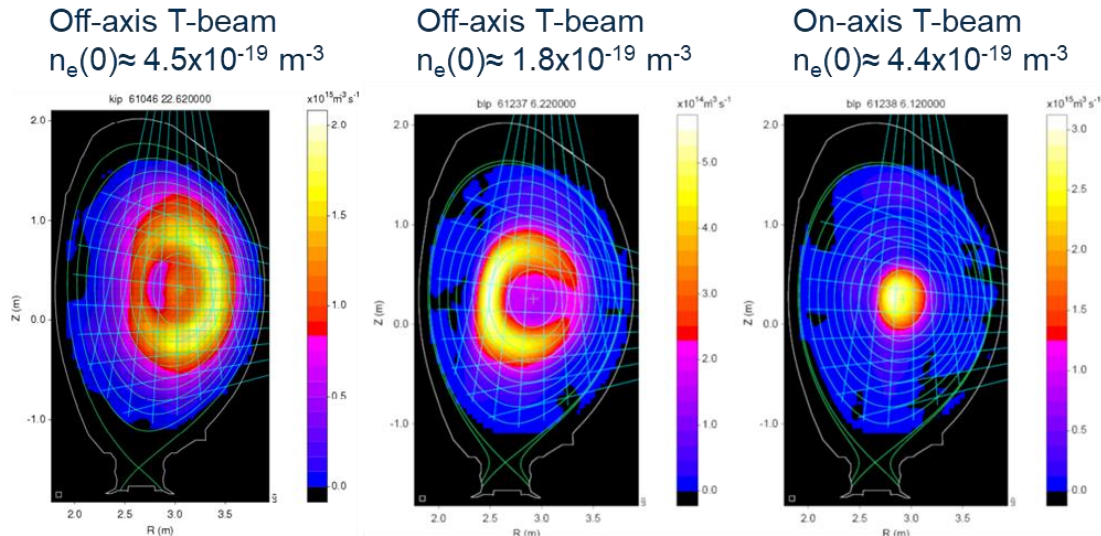

Also used for taking preventive or mitigating actions against impending disruptions by monitoring the radiated power in different plasma regions.

Computationally intensive task typically performed using machine learning.

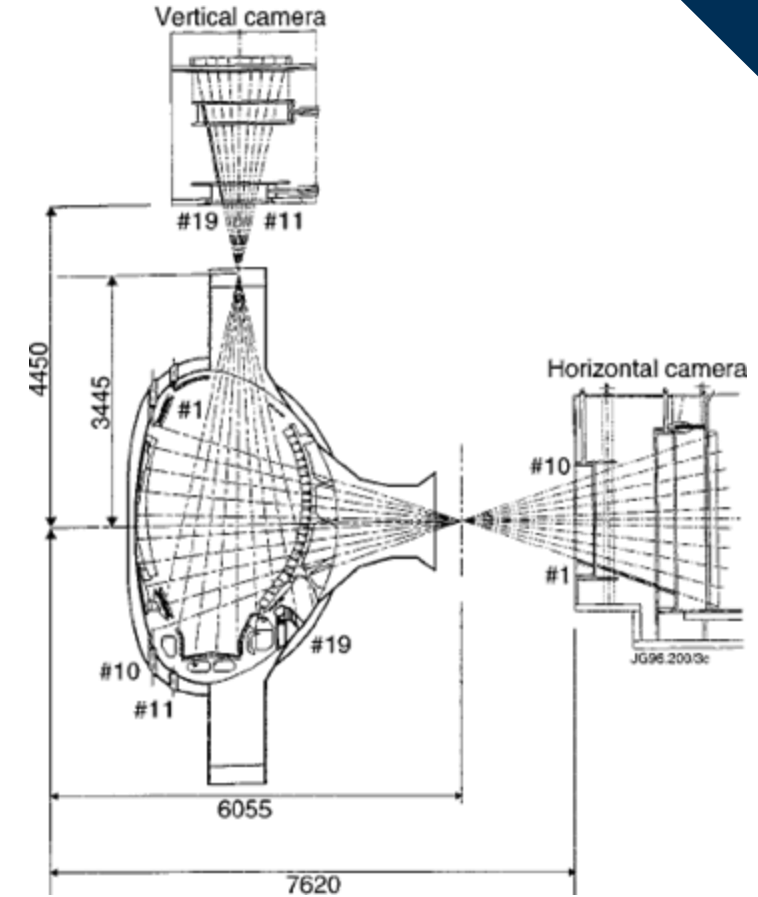

<https://www.researchgate.net/publication/253863077> Neutron profile measurements for trace tritium experiments

Neutron activation (KN2)

Usually, the $^{115}\text{In}(n,n')^{115m}\text{In}$ activation reaction is used for DD neutrons and $^{28}\text{Si}(n,p)^{28}\text{Al}$, $^{63}\text{Cu}(n,2n)^{62}\text{Cu}$, $^{93}\text{Nb}(n,2n)^{92m}\text{Nb}$ reactions for DT neutrons

Short term irradiation (8 ends in total, 2 are used)

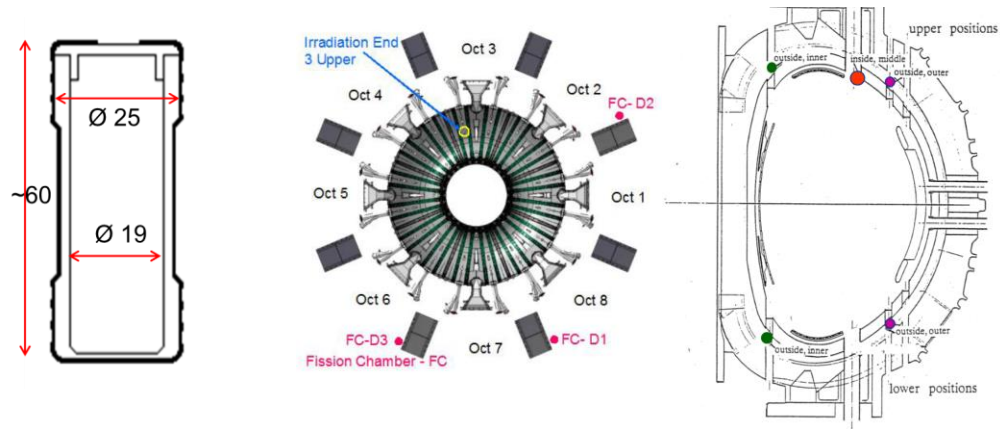

Long term irradiation

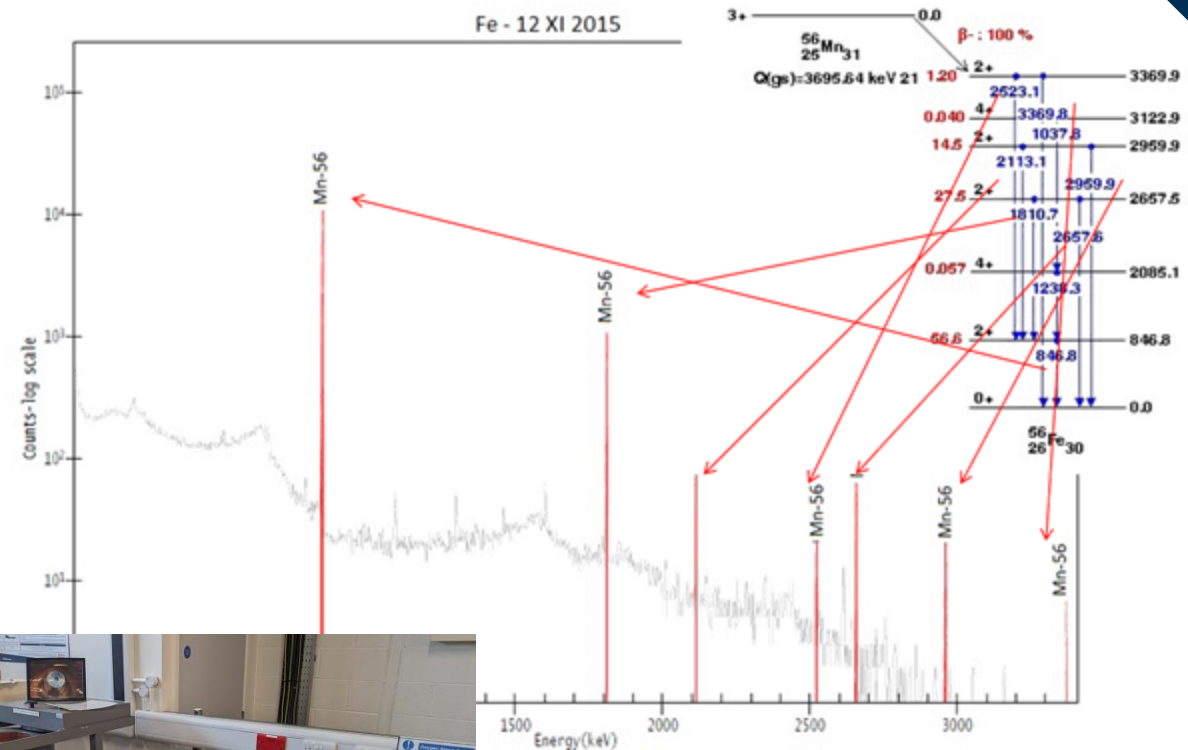
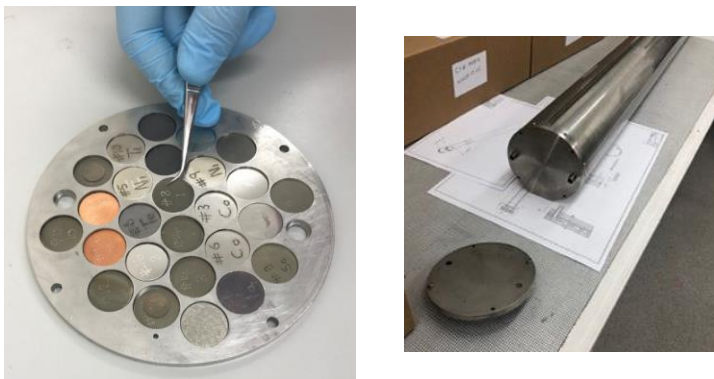

Neutron spectrum unfolding

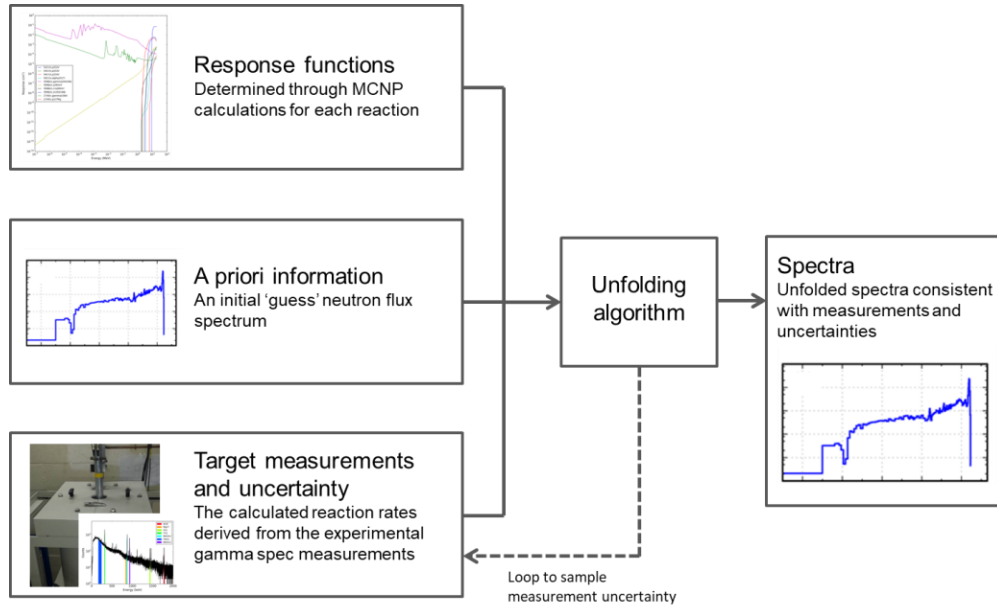

Activity induced in the foils can be used to infer the neutron energy required to generate those activities.

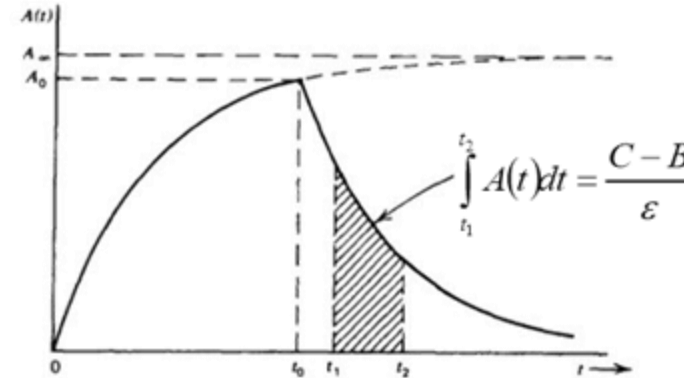

C = total number of counts in $t_2 - t_1$,
 B = the number of background counts in $t_2 - t_1$,
 ϵ = the overall counting efficiency (including any self-absorption effects);

Wide variety of existing algorithms:

- MAXED
- GRAVEL

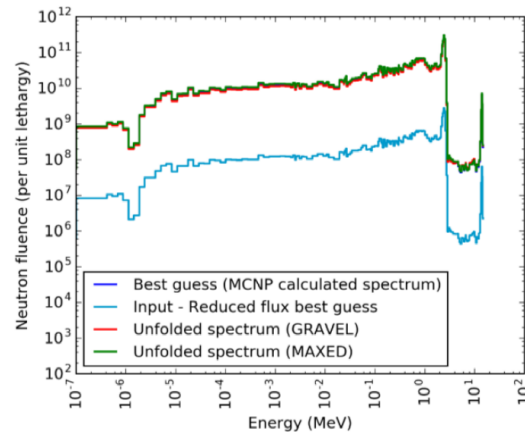

- Because the activity is continuously decaying during this stage, careful account must be made of each of the times involved.
- If the counting is carried out over an interval between t_1 and t_2 , the number of counts, C ,

$$C = \epsilon \int_{t_1}^{t_2} A_0 e^{-\lambda(t-t_0)} dt + B$$

$$A_\infty = \frac{\lambda(C - B)}{\epsilon(1 - e^{-\lambda t_0})e^{\lambda t_0}(e^{-\lambda t_1} - e^{-\lambda t_2})}$$

from A_∞ the neutron flux can be determined

Time resolved neutron yield monitor

KN1 Fission Chambers

- Incoming neutrons must be thermalised, in this case using polythene and lead
- Thermal neutrons interact with a thin layer of highly enriched uranium (HEU) producing fission fragments with high kinetic energy and causing ionizing radiation.
- The uranium layer must be thin enough for the fission fragments to escape and enter the filling gas between the electrodes.
- A voltage is applied between the anode and the cathode, and the produced electric current is proportional to the neutron flux.

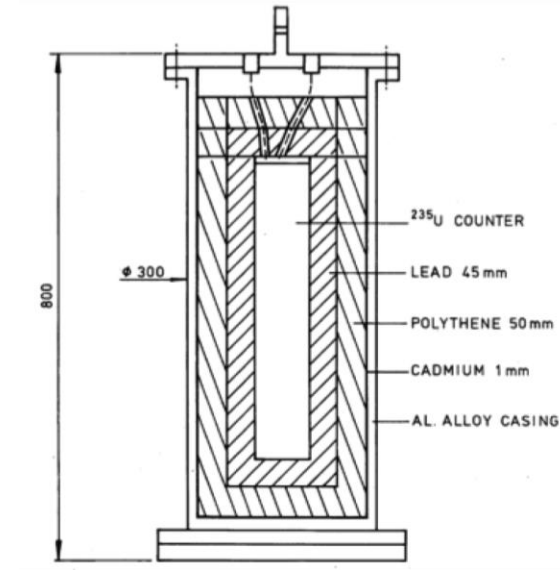

- Three U-235/U-238 pairs of fission chambers located around JET to monitor the time evolution of the neutron emission rate
- **Neutron yields** can be measured ranging from 10^{10} to 10^{20} n/s
- Fission chambers are insensitive to neutron energy
- Intensive Monte Carlo codes need to be run to determine the fraction of scattered/direct neutrons in order to apply a correction coefficient to the measurements.

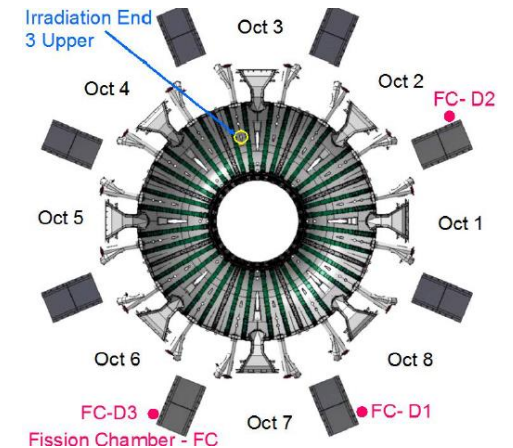

Calibrating the fission chambers

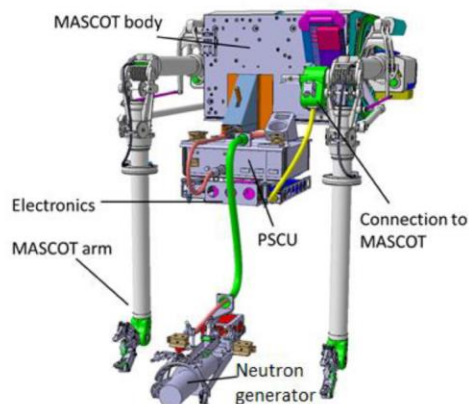

The KN1 fission chambers are located ex-vessel - this means neutrons born in the plasma have scattered on a variety of materials prior to detection.

To calibrate the diagnostics and verify the Monte Carlo simulations DT neutron generators were deployed using MASCOT.

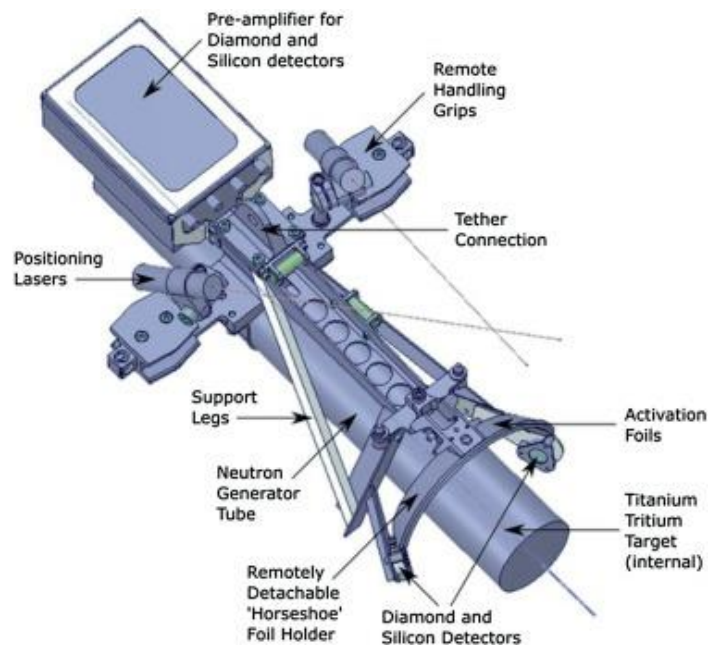

The neutron generators were characterised prior to deployment at the National Physical Laboratory (NPL, Teddington) and was modified to include a “horseshoe” of activation foils, diamond detectors and silicon detectors to verify the output of the neutron source and the angular distribution of the neutrons emitted.

Once the output was well known the generator was deployed in JET and the fission chambers could be calibrated from this well characterised output.

Diamond detectors

DTE2 saw an enhancement of the nuclear diagnostics used on JET, including the use of single crystal diamond-based detectors along collimated lines of sight to measure 14 MeV neutron yield.

The best production technique is the chemical vapor deposition (CVD) which can grow electronic grade single crystal diamonds detectors, suitable for radiation detection purposes.

Electron–hole pairs are generated by the charged particles produced via neutron-induced nuclear reactions with the carbon and the charge associated is proportional to the energy of the neutron, the key reactions are:

- $^{12}\text{C}(n,n')^{12}\text{C}$
- $^{12}\text{C}(n,n')3\alpha$
- $^{12}\text{C}(n,\alpha)$

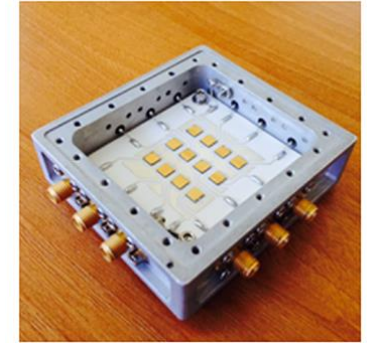
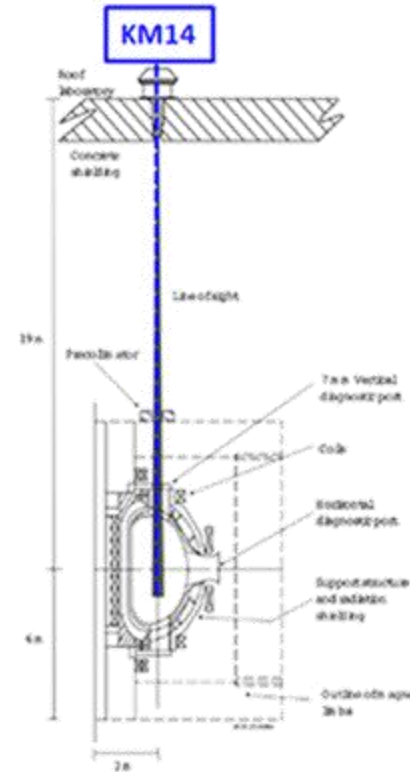
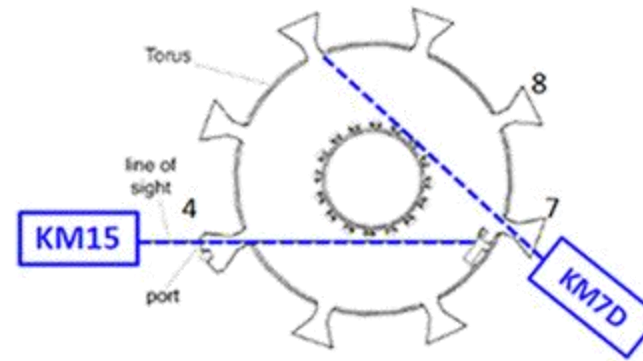
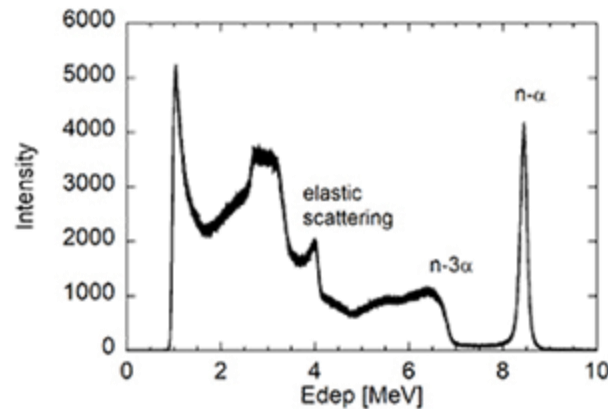

Day 2:

- Future machines**
- Challenges of neutron spec in power plants**

Fusion energy research over time

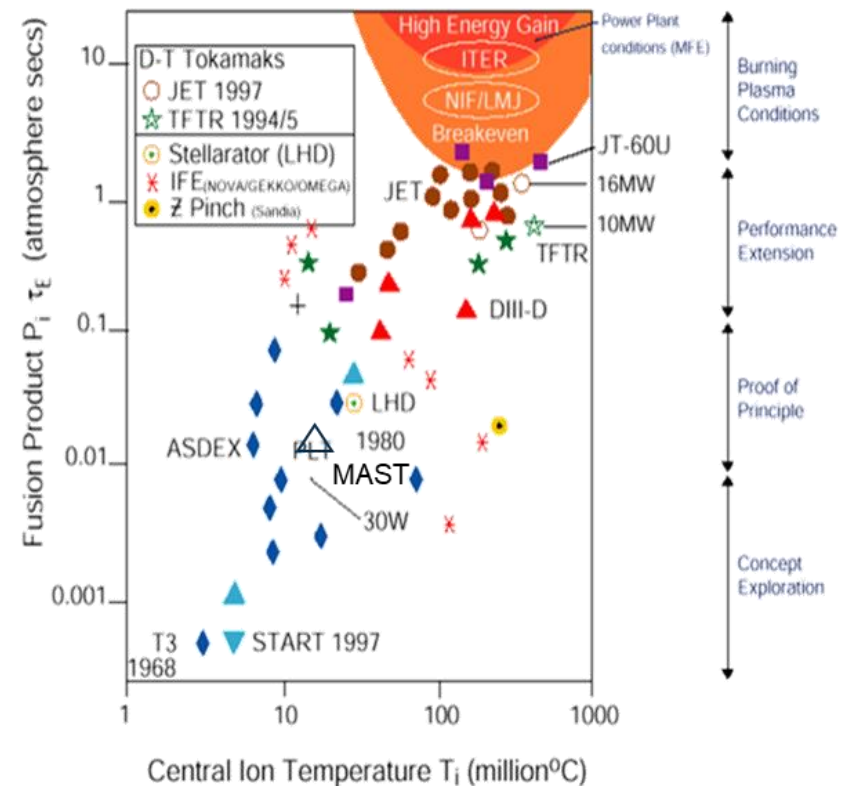
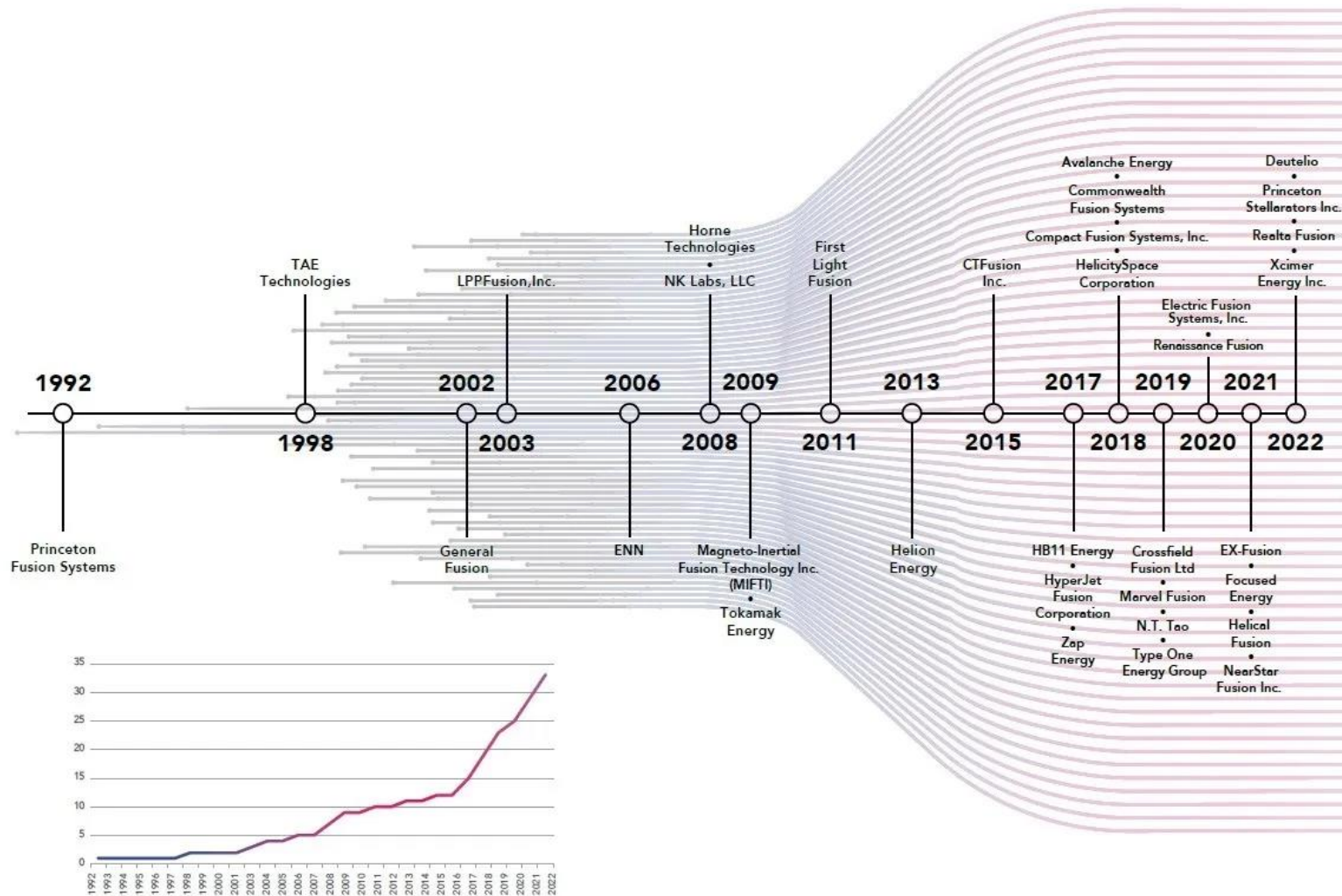

**Fusion energy is entering the technology delivery phase
Tokamaks are the most developed technology at present**

ITER – Latin for “the way”

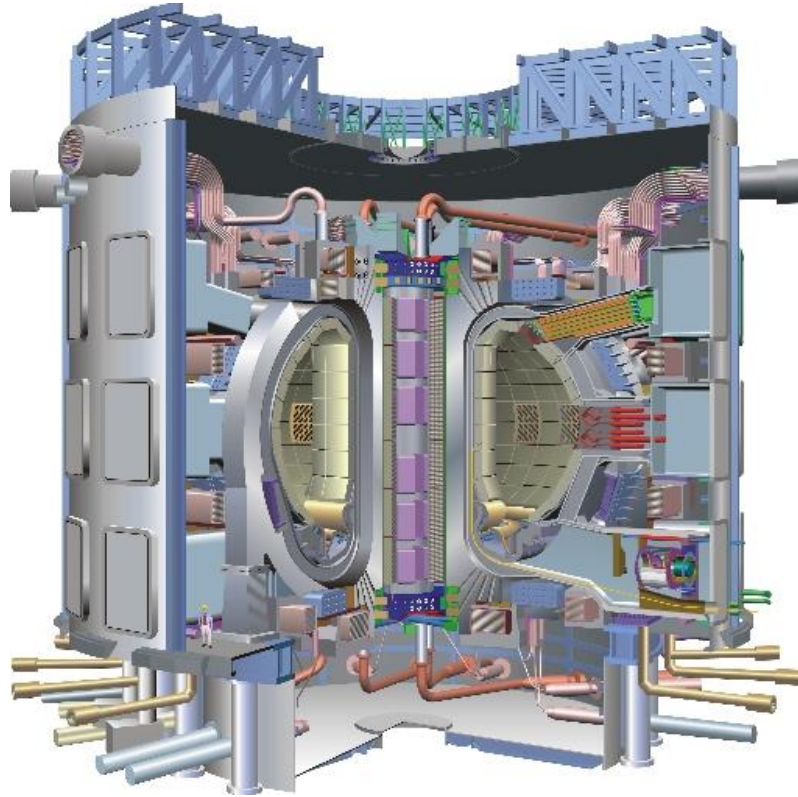

Conventional tokamak, like JET, using neutral beam injectors (NBIs) and radio-frequency waves to heat the plasma to 150 million °C. The vacuum vessel (plasma volume) will be 10x bigger than in JET.

- Magnets – 10,000 tonnes of superconducting magnets generating a field 200,000 times that of the Earth’s magnetic field will confine and shape the plasma
- Blanket – tiles weighing up to 4 tonnes will protect the vacuum vessel and magnets from heat and neutrons

One of ITER’s primary goals is to prove that fusion reactions can produce significantly more energy than the energy supplied to initiate the reaction process — resulting in an overall gain in power.

ITER’s 35 participating nations represent more than half of the world’s population



ITER's Blankets



There is a limited supply of tritium, currently produced as a low-abundance biproduct in fission reactors (we get most of ours from CANDU reactors). Tritium has a half-life of 12.33 years, and the rate at which tritium is currently produced is not sustainable for fusion power plants.

It must therefore be made in-vessel, a mechanism yet to be demonstrated fully.



ITER will have 440 blanket modules, those containing lithium are referred to as breeder blankets. ITER will test four breeder blanket concepts in dedicated ports in later phases of operation.

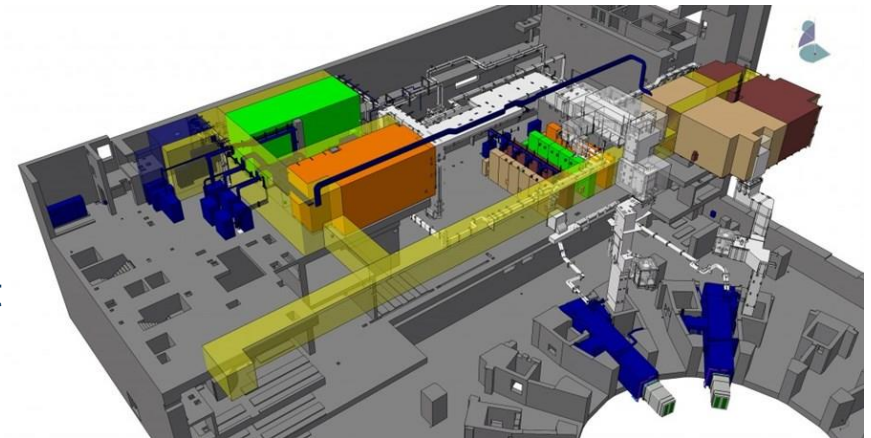

The successful development of tritium breeding is essential for the future of fusion energy.

DEMO – the demonstration power plant



DEMO must demonstrate the necessary technologies not only for controlling a more powerful plasma than has previously existed, but for safely generating electricity consistently, and for regular, rapid, and reliable maintenance of the plant, as well as commercial viability.

The ITER Members all have a different notion of what their DEMO could be.

A central requirement for the European DEMO is to produce 300-500 MW of net electricity to the grid (approx. 3-4 times less than an average nuclear fission reactor).

Europe's DEMO would be a "demonstration power plant" to be followed by the first-of-a-kind fusion power plant.

While still in design it is expected to be larger than ITER

European DEMO targets fusion power on the grid by 2050

Indian DEMO targeting construction in 2037

South Korea targets electricity generation in 2050

USA targets construction of DEMO after 2050

Conventional Tokamak Dimensions

- The confinement time of a tokamak plasma scales with plasma size and so it is generally expected that the fusion triple product, $nT\tau_E$, will also increase with size
- This has been part of the motivation for building devices of increasing size including ITER and EU DEMO.

Spherical tokamaks, like MAST-U

- Have a squashed, compact shape – like a cored apple rather than a ring doughnut
- More efficient, more stable, fewer disruptions, improved confinement.
- Early concepts were dismissed as a contender for fusion power plants because the lack of space in the centre of the machine made it difficult to generate the high magnetic fields required for fusion while also protecting the centre column from neutron bombardment.
- Developments in superconductors and high-temperature superconductors have started to change the game.

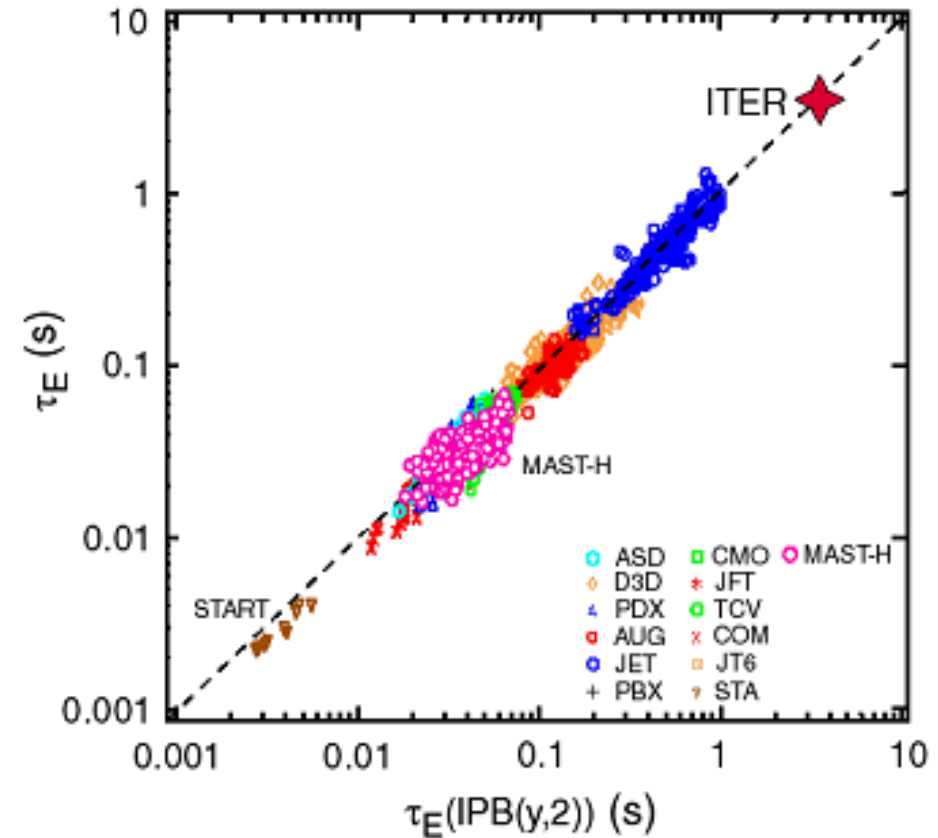

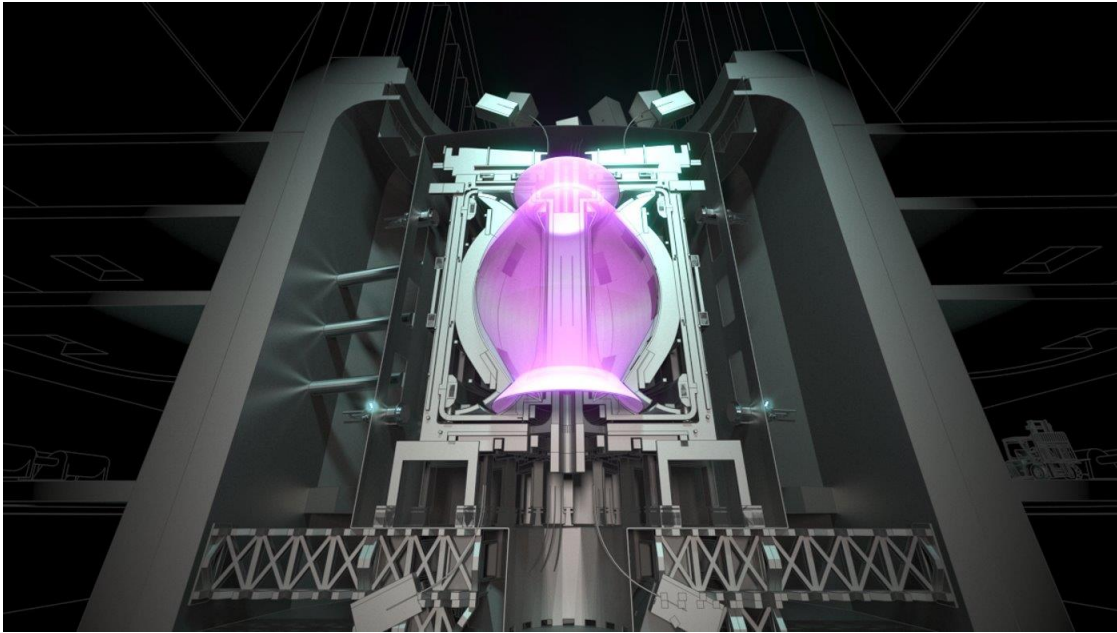

Building a prototype fusion power plant with the aim to demonstrate net energy from fusion targeting 2040.

This will support the potential development of a fleet of future fusion powerplants around the world and seeks to ensure that the UK remains at the forefront of a new technology and emerging industry.

Goals:

- Demonstrate the ability to put net electricity on the grid.
- Demonstrate how the powerplant can be maintained through its operational life and produce its own fuel.
- Develop UK industry and manufacturing capabilities in preparation for powerplant roll out.



Environment gets more intense

- Temperatures ranging from 100-450 degrees (at diagnostics locations - tritium breeding module environments particularly challenging).

JET: Approximately 50-100 degrees

- Magnetic fields ranging from 1-10 Tesla

JET: ~3 Tesla

- Neutron flux 10^{12} - 10^{16} n/cm²/s

JET: 10^9 - 10^{10} n/cm²/s

- Also, gamma radiation, vibrations, dust, etc.

JET: less intense, diagnostics more easily accessed, shorter operations

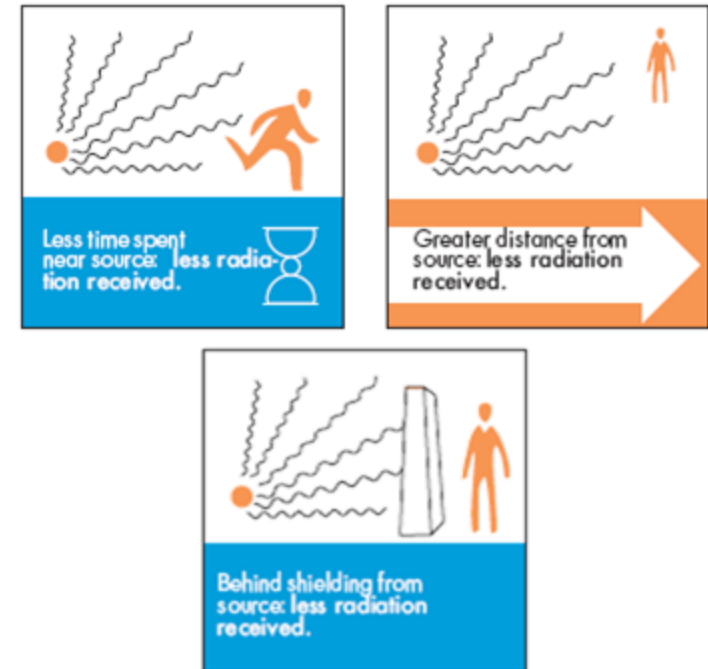

Ethos:

- **Move diagnostics further away** – while minimising lines of sight
- **Shield** – while minimising perturbation of the field
- **Redesign** – takes time and requires qualification
- **Use as little as possible** – diagnostics on power plants will be minimal, aiming at control (not science)

Challenge:

We don't know the exact environments or requirements for future machines but may be required to provide solutions quickly to inform design/planning.

Radiation transport (neutronics) methods

There are two broad types of methodology used for simulations:

- **Deterministic** - solves the Boltzmann transport equation for a flux solution either through angular (discrete ordinates/Legendre polynomials), energy (multi-group) or space-time simplification
 - Pro: Can solve for a whole reactor (as done by industry)*
 - Con: Discretization introduces errors: cross sections, scattering direction, space over curved bodies*
 - ‘Gives an exact solution using an approximate representation of the physics of the problem’*
- **Monte-Carlo (probabilistic)** - uses continuous physics and faithful geometry to follow individual particles one-by-one until enough done to converge
 - Pro: As good of a solution as possible with physics knowledge*
 - Con: Potentially huge computational requirement and only local information (where particles are statistically tallied)*
 - ‘Gives an approximate solution using a more exact representation of the physics of the problem’*

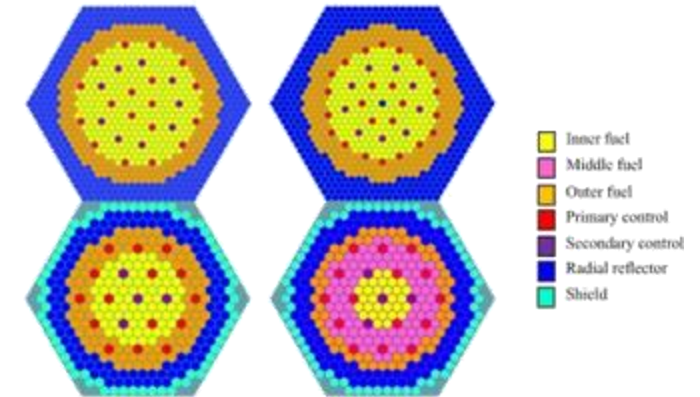

The area I work in: Neutronics and nuclear data

CAD model

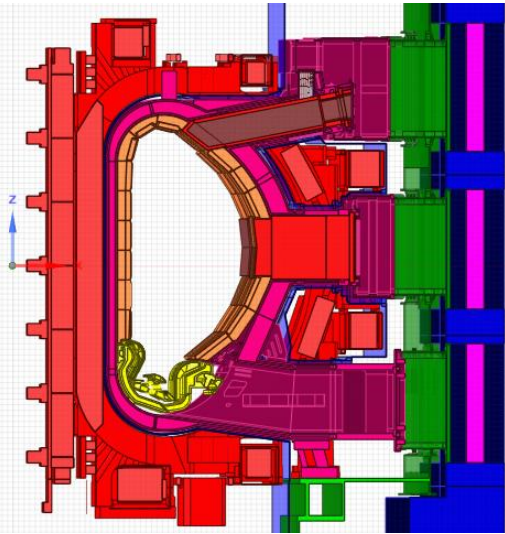

Monte Carlo
radiation transport

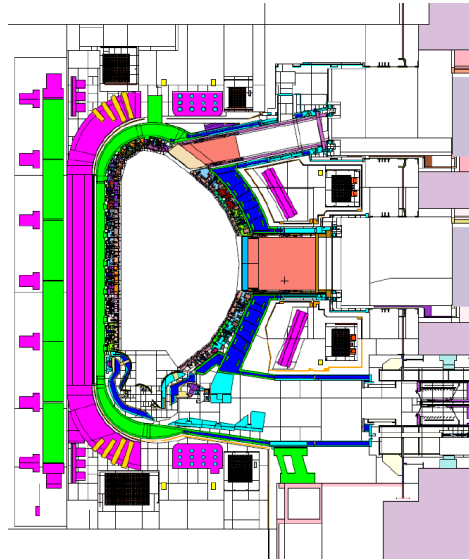

Nuclear Analysis

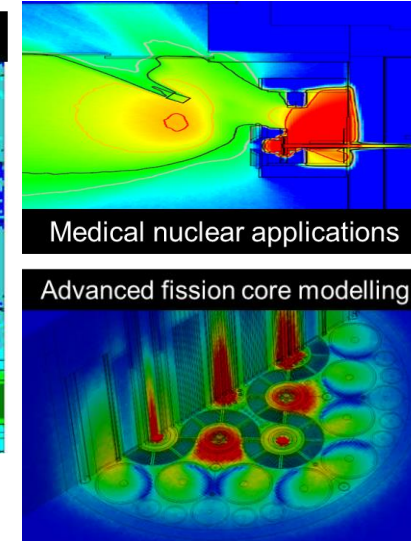
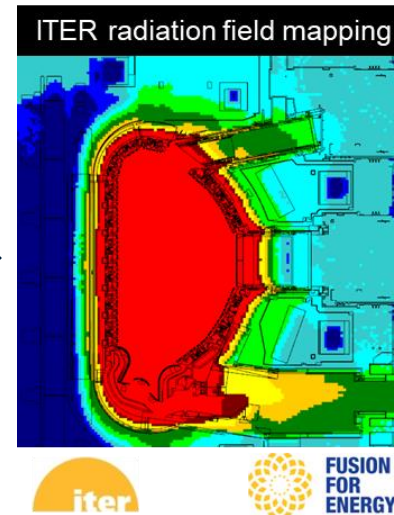

Nuclear responses:

- Particle flux
- Dose rates
- Nuclear heating
- Tritium production
- Material damage
- Gas production
- Material activation
- Radiological waste
- Detector responses

The Monte Carlo method

Follow individual particles and track them until their 'death' through e.g. absorption or by escaping the boundaries of the problem

Repeat the process many times and predict the average behaviour of particles in a system

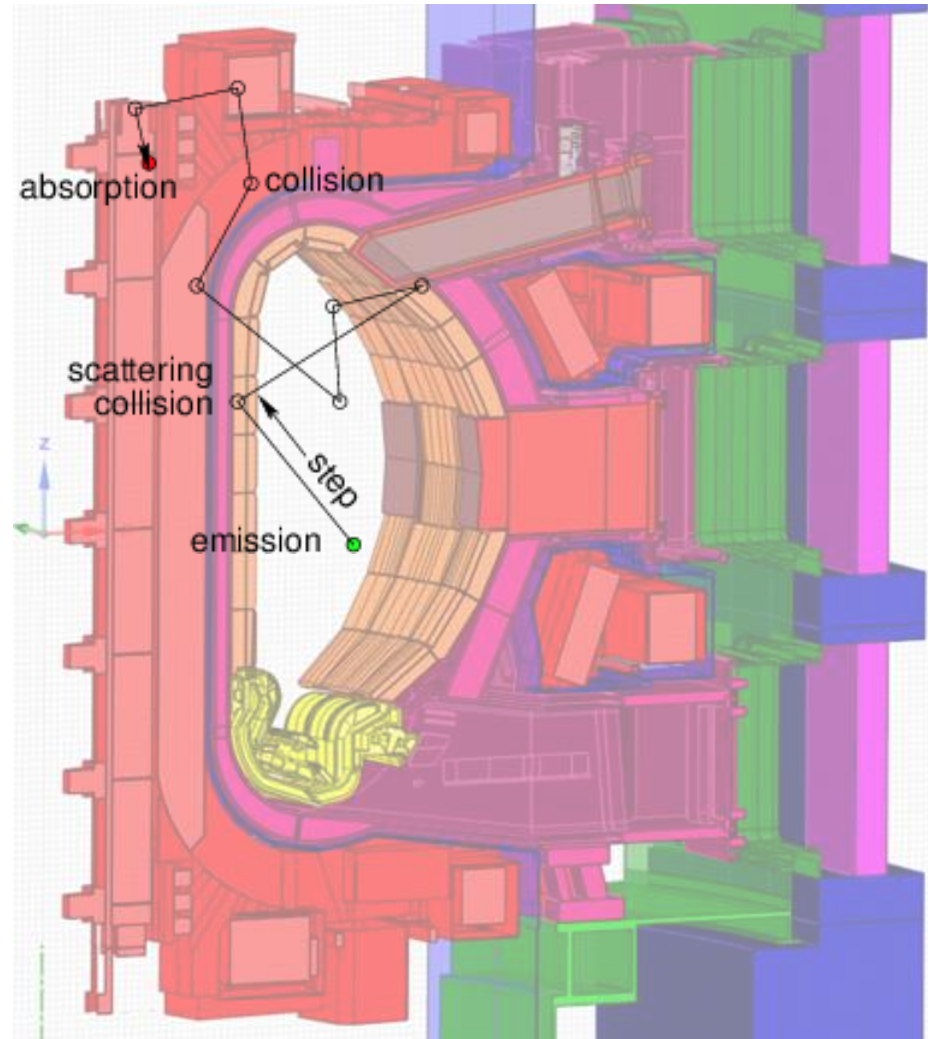

The strength of this method is in its capability to calculate statistical estimates for **integral reaction rates** without explicitly solving for the flux distribution.

Frequency and outcome of interactions determined by **random sampling** and simulated according to **interaction laws** from particle and nuclear physics

Modelling with Uncertainty

Due to the complexity of fusion devices, there are multiple competing requirements:

- Cost
- Shielding
- Breeder material
- Cooling capability
- Energy extraction
- Diagnostics
- Maintenance

To make informed decisions on these requirements it is important to understand the underlying uncertainties (e.g., component lifetimes or tritium breeding, and safety factors).

There are many sources of uncertainty in nuclear analysis workflows:

- covariances in nuclear data;
- statistical uncertainty from transport calculations;
- geometric approximations and the design maturity;
- material definitions, particularly for novel materials.



Boron carbide (B4C) validated by ITER as a shielding material for diagnostics.

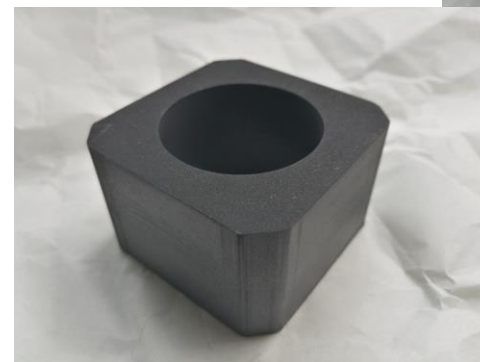

Resilient diagnostics

Radiation, temperature, magnetic field

1. Making better use of diagnostic systems that are inherently radiation hard
 - Activation foils – encapsulation and machine learning
 - Coolant systems – intentional dopants
 - Diamond detectors
 - Hollow core fibres
2. Shielding diagnostics to make them radiation hard
 - Can perturb the results
 - Adds to cost and reduces space
 - Makes maintenance potentially more challenging
 - Requires re-qualification
3. R&D to make diagnostics radiation hard
 - Understanding failure modes
 - Require appropriate testing environments
 - Takes time

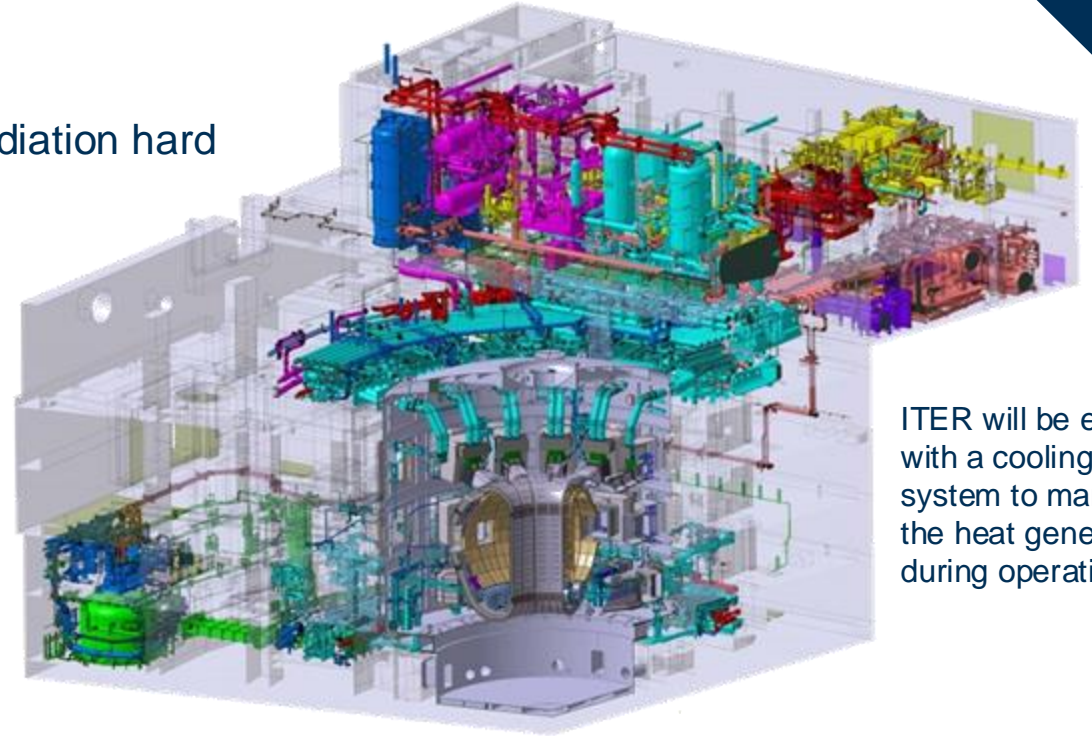

ITER will be equipped with a cooling water system to manage the heat generated during operation.

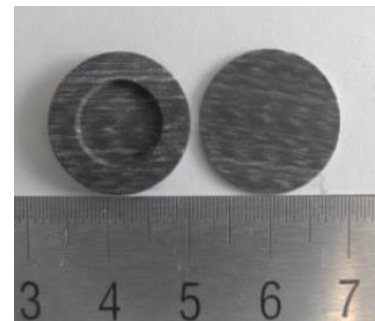

Fluid Activation and ACPs

- Movement of fluids around coolant/tritium breeding circuits are an important consideration in fusion reactors
 - Can take activated fluids outside of the biological shielding posing risk to personnel
 - Can cause issues with the positioning of safety important sensitive equipment
 - Can affect the overall activity/decay heat of material inside the reactor
- When passing through radiation areas the fluids will become activated, and in non-radiation areas the activation products will decay.
- Predicting the dose rate from activated fluids is complicated, you must consider:
 - Fluid dynamics – how the fluid moves through the network of pipes, and this depends on the type of fluid, the geometry of the pipes, the temperature/density which could vary depending on location in the system.
 - ACPs – activated corrosion products. Corrosion products will enter the system and could become activated in radiation areas, these not only add to the dose of the fluid but can deposit and accumulate within the pipe network.

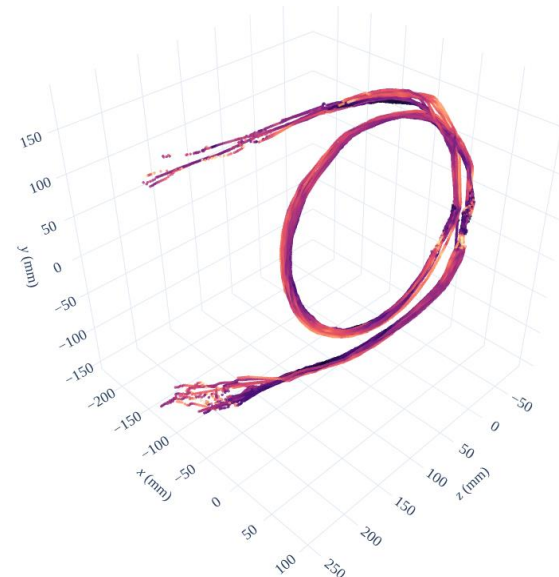
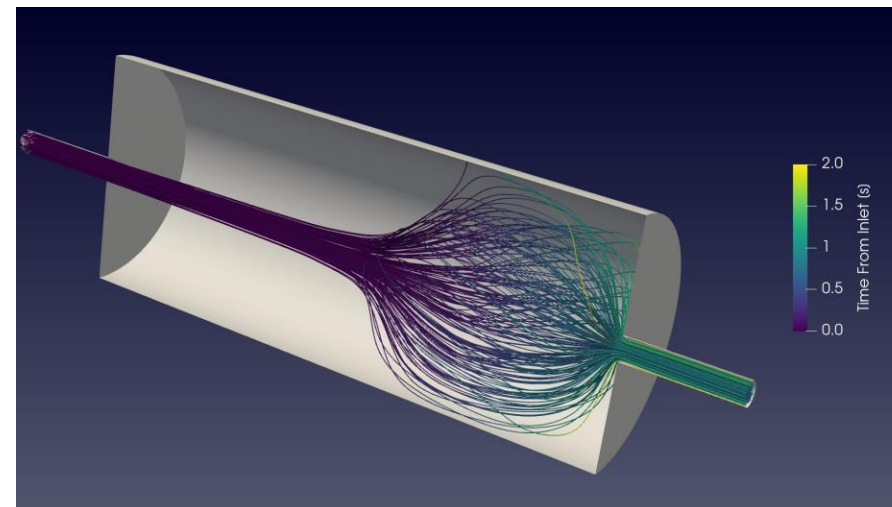

PEPT imaging
techniques can be
used for validation



UNIVERSITY OF
BIRMINGHAM

Machine Learning

Compton suppression typically requires a hardware solution, for example veto detectors.

Machine learning offers a digital technique to effectively reduce the Compton background using the raw signals and training the algorithm on real vs Compton events. This enhances data collected for any detector and removes the cost of purchasing equipment.

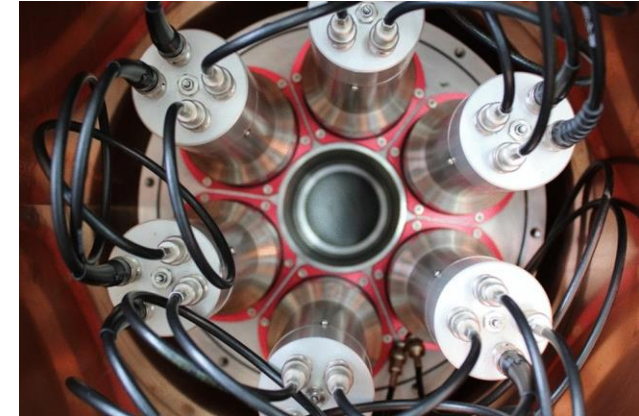

When trying to unfold neutron energy spectra (typically 175 or 709 energy bins) the problem is hugely under-determined.

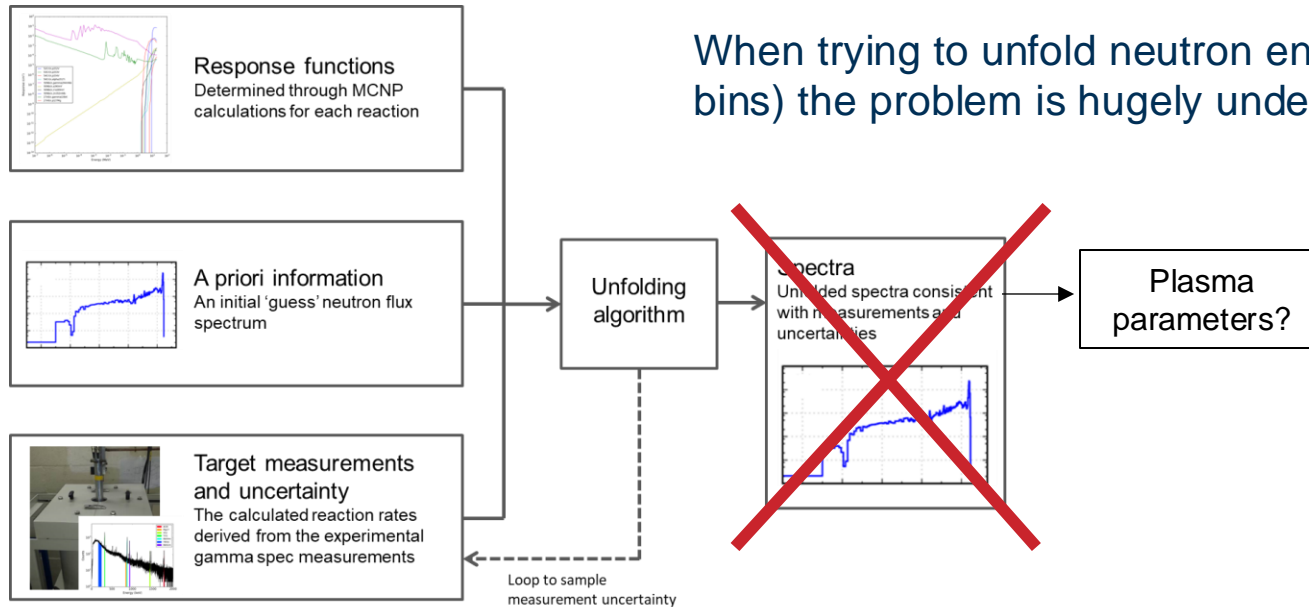

Instead:

Is there a relationship between the energy of the neutrons produced and the plasma parameters (temperature, density, etc)?

Understanding failure modes

Simple fixes:

- Using temperature resistant materials
- Making components easy to replace
- Applying correction factors to off-set the degradation

Complex fixes:

- Single Event Effects – explored in the latest JET campaign. It has been shown neutrons randomly cause malfunctions or failures in electronic devices.
 - Single Event Upsets (SEUs): normally appear as transient pulses in logic or support circuitry, or as bitflips in memory cells or registers.
 - Single Event Latchup (SEL): results in a high operating current and must be cleared by a power reset.
- It's not always practical to just put the electronics further away (weak signals will be lost), so we need to understand these effects and mitigate them if we can.
- Results coming soon

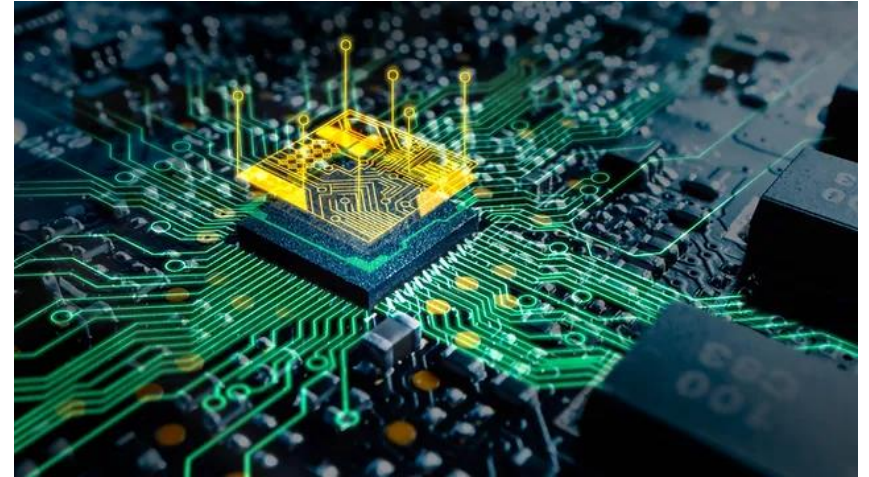

Optical fibres

Optical fibres are a great way to transmit information – potentially allowing us to place electronics further from the harsh environment of the machine.

However, traditional solid fibres suffer from an effect known as darkening, a loss of the propagating optical signal leading to decreased power at the output end. This can be influenced by:

- Radiation
- Glass composition
- Operating wavelength
- Dose rate and total accumulated dose
- Temperature
- Power propagating through the core

Alternative: Hollow core fibres?

- Demonstrated with promising tolerance to gamma and some neutron fields
- Requires more research to explore applications for fusion in neutron diagnostics, also magnetic field sensors and tritium detectors.

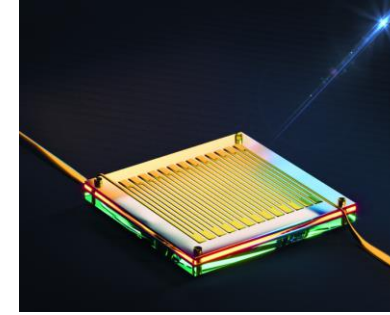

Untapped area: Quantum sensors

Capable of extracting information from a single photon, making these darkening effects less problematic.

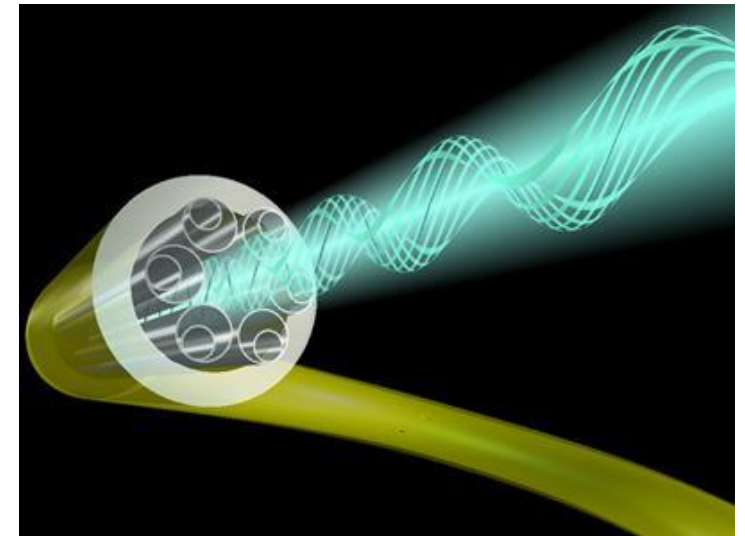

Where to qualify?

For R&D of novel diagnostics and for demonstrating the effectiveness of shielding for existing diagnostics qualification is required.

The level of qualification is dependent on the application i.e. safety systems will require a higher confidence level.

MC40 Cyclotron

Can produce deuterons up to 20 MeV. Targets can be used to get neutrons of desired energy ranges.

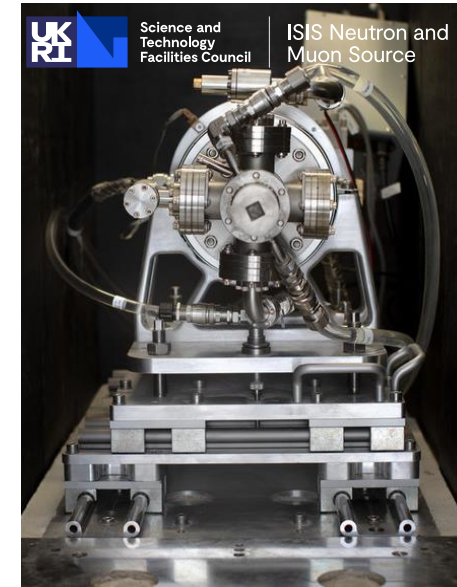
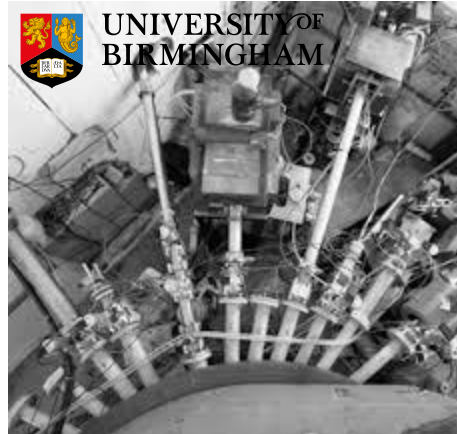

Neutron Irradiation Laboratory for Electronics (NILE)

DD and DT neutron generator

Van de Graaff accelerator

Produces neutrons between 8-17 MeV



ASP Facility

14 MeV DT neutrons, 10^{11} n/s

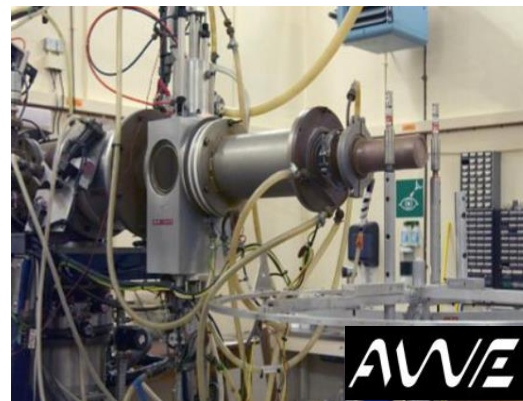

High Flux Accelerator-Driven Neutron Facility (HF-ADNeF)

Protons onto a lithium target. ~ 1 MeV neutrons, 10^{13} n/s

Future Facilities

IFMIF-DONES

International Fusion Materials Irradiation Facility DEMO Oriented Neutron Source



- For testing materials in fusion relevant irradiation conditions.
- Currently in design, planned construction in Granada, Spain.
- Flux in the high flux test module $\sim 10^{14}$ n/cm²/s

LIBRTI

Lithium Breeding Tritium Innovation

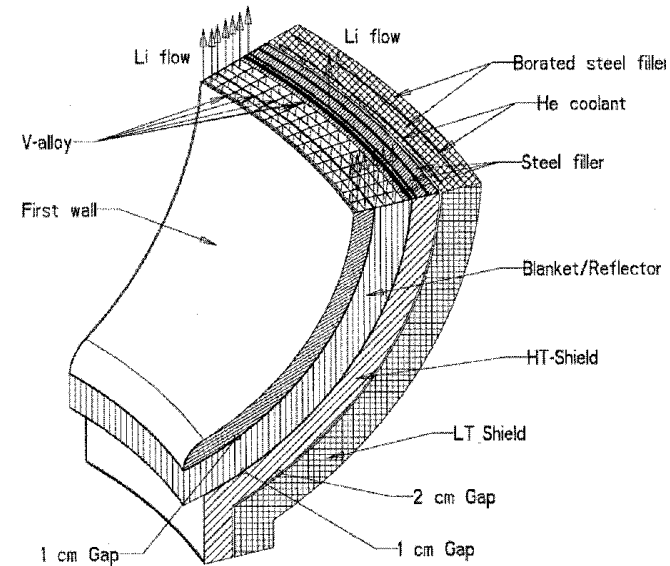

Breeder blankets are complex components that are critical to the success of fusion.

Many concepts exist, with not many places to qualify at the engineering scale.

- 14 MeV neutrons
- Capacity for large mock-ups to experimentally test key questions that remain about the tritium fuel cycle.
- Also provides an environment to qualify diagnostics.

Passive Neutron Spectrometer



Bonner Spheres:

Neutrons slowed down by moderator shells of different thickness, with a detector in the centre of the shell.

Each sphere must be placed in the same location in turn.

<https://www.ptb.de/cms/en/ptb/fachabteilungen/abt6/fb-64/643-neutron-spectrometry/nemus.html>

Thermo-luminescence detectors (TLDs) along an optimised number of axes embedded in high-density polyethylene (HDPE).

Dose is induced in the TLDs by incident neutrons, higher energy neutrons will be more penetrating.

The dose can be measured by removing the TLDs and heating them to measure the light emitted.

Minimum measurable sensitivity of 1 – 10 μGy . The intention is to deploy systems like this to low dose environments for commissioning and radiation protection.

Future work to explore an active system.



Useful reading

- J. Lilley 'Nuclear physics: principles and applications' (Wiley)
- Chen 'Introduction to Plasma Physics and Controlled Fusion' (Springer)
- G. McCracken, P. Stott 'Fusion – the energy of the universe' (Elsevier)
- A. Harms, K.F. Schoepf 'Principles of fusion energy' (World Scientific)
- J. Wesson, 'Tokamaks' (Oxford Science)
- S. Glasstone and R Lovberg, 'Controlled thermonuclear reactions', (Van Nostrand, New York 1960)
- Boyd and Sanderson 'The Physics of Plasmas' (Cambridge 2003)
- Goldstone and Rutherford – 'Introduction to Plasma Physics' (IOP 1995)

Useful websites:

<https://ccfe.ukaea.uk>

<https://www.euro-fusion.org>

<https://www.pppl.gov>

<http://www.iter.org>

<http://fusionforenergy.europa.eu>

Useful journals:

Nuclear Fusion, IoP

Fusion Engineering and Design, Elsevier

+several others