

Design an IACT for VHE gamma-rays

ACME Online Course

Support Material

Oscar Blanch Bigas

OUTLINE of the Course

- Support Material
 - Extended Air Showers
 - Imaging Air Cherenkov Technique
 - Telescopes
 - i. Angular resolution
 - ii. Light Collection Power / Sensitivity
 - iii. Field of View
 - iv. Atmospheric Window / Site Selection
 - v. Beyond Optical Wavelength
 - vi. Mirror Manufacturing
 - vii. Telescope Structure
 - viii. Camera
 - ix. Auxiliary Systems
- Guidelines to design an Imaging Air Cherenkov Telescope
- Online discussion on proposed designs

Image Air Cherenkov Telescope

Quite some of them have already been built

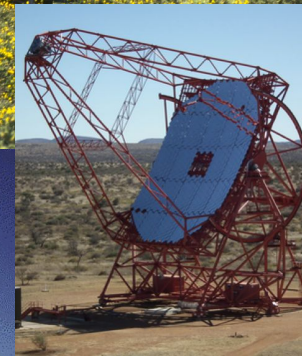
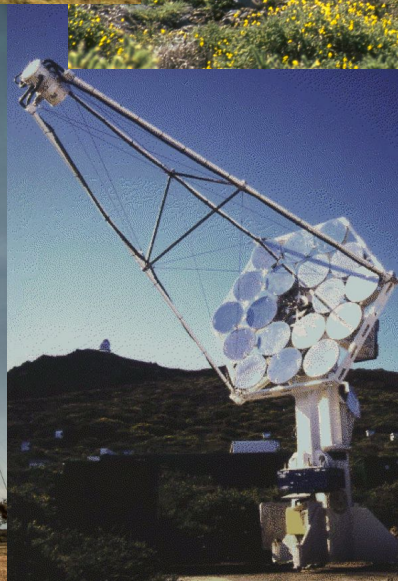
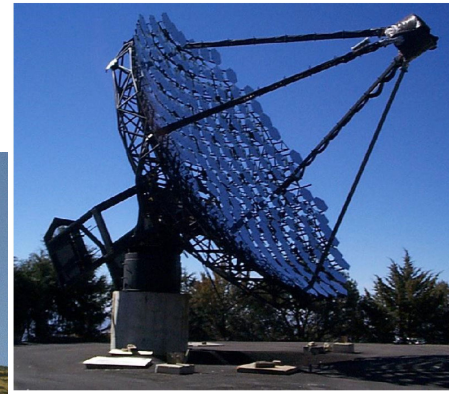

Image Air Cherenkov Telescope

- In terms of hardware instrumentation, the IACTs can be divided in three parts:
 - Structure
 - Reflective Surface
 - Camera
- This does not fully contain all that is needed to have them operative, some other elements are:
 - Auxiliary Systems
 - Control Software
 - Readout and storage



Extended Air Showers

Electromagnetic Shower

High energy electrons/positrons or photons when interacting with matter produce an electromagnetic shower.

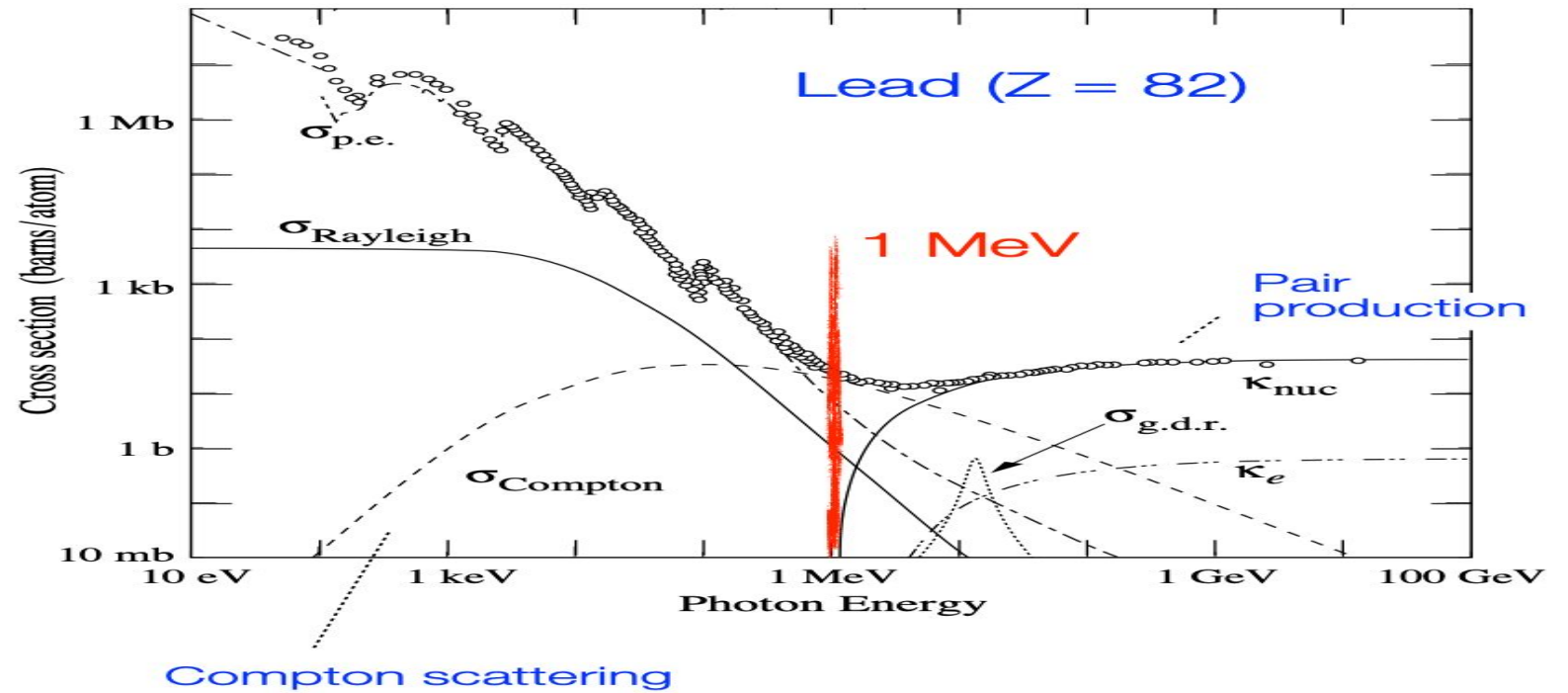
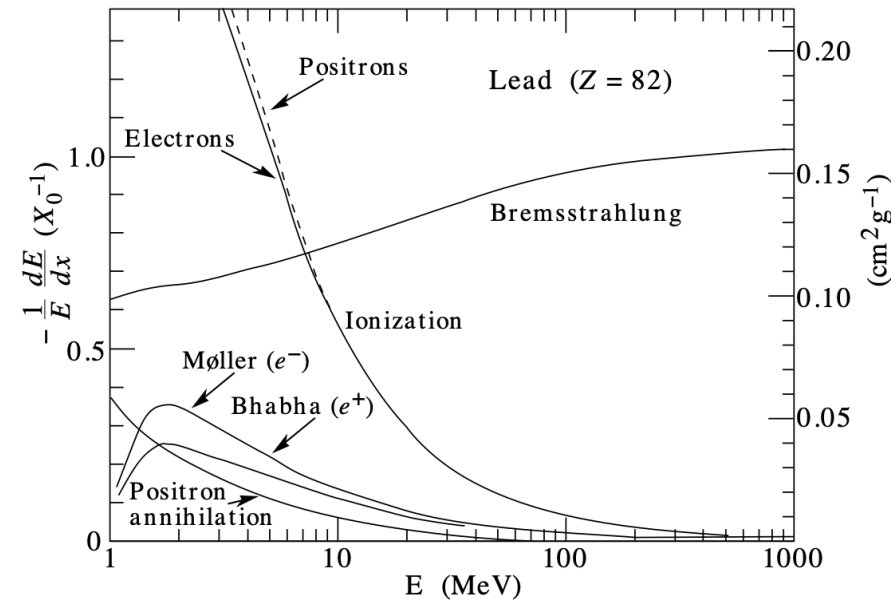

Electromagnetic Shower

At high energy the dominant processes are:

- Photons: Pair production
- Electrons: Bremsstrahlung

$$\sigma_{\text{pair}} \approx \frac{7}{9} \left(4\alpha r_e^2 Z^2 \ln \frac{183}{Z^{1/3}} \right)$$

$$\frac{dE}{dx} = 4\alpha N_A \frac{Z^2}{A} r_e^2 \cdot E \ln \frac{183}{Z^{1/3}} = \frac{E}{X_0}$$

$$\mu = n\sigma = \rho \frac{N_A}{A} \cdot \sigma_{\text{pair}} = \frac{7}{9} \frac{\rho}{X_0}$$

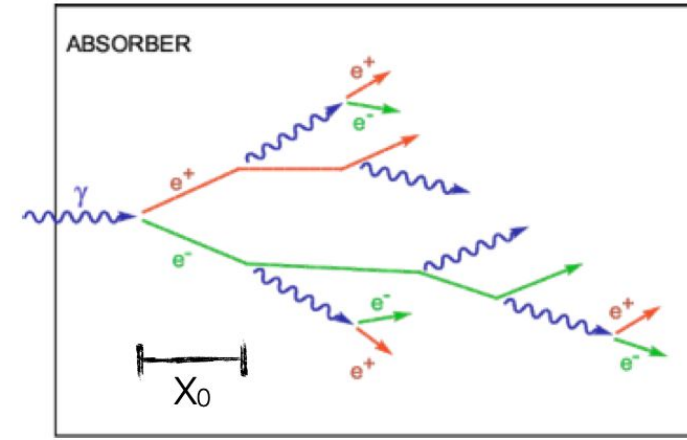

Critical Energy

Below critical energy, incident electron loses energy through ionisation

$$\left. \frac{dE}{dx}(E_c) \right|_{\text{Brems}} = \left. \frac{dE}{dx}(E_c) \right|_{\text{Ion}}$$

$$E_c^{\text{Gas}} = \frac{710 \text{ MeV}}{Z + 0.92} \quad \left[E_c^{\text{Sol/Liq}} = \frac{610 \text{ MeV}}{Z + 1.24} \right]$$

$$\left(\frac{dE}{dx} \right)_{\text{Brems}} / \left(\frac{dE}{dx} \right)_{\text{Ion}} \approx \frac{Z \cdot E}{800 \text{ MeV}}$$

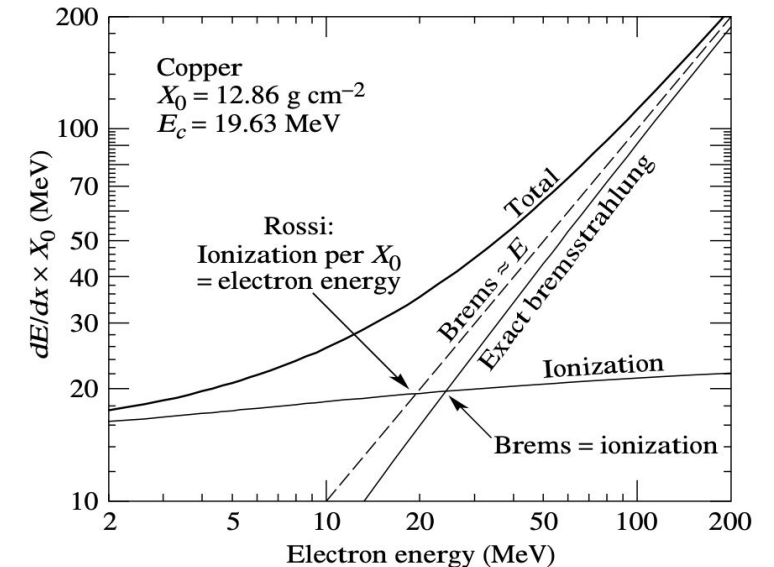

Electromagnetic Shower

Transverse size of EM shower is also related to the radiation length via Molière radius

$$R_M = \frac{21 \text{ MeV}}{E_c} X_0$$

E_c = Critical Energy
 X_0 = Radiation length

	X_0 [cm]	E_c [MeV]	R_M [cm]
Pb	0.56	7.2	1.6
Scintillator (Sz)	34.7	80	9.1
Fe	1.76	21	1.8
Ar (liquid)	14	31	9.5
BGO	1.12	10.1	2.3
Sz/Pb	3.1	12.6	5.2
PB glass (SF5)	2.4	11.8	4.3

Electromagnetic showers also develop in the air (Extended Air Showers):

- Radiation Length: 300 m
- Critical Energy: 87 MeV
- Molière Radius: 73 m

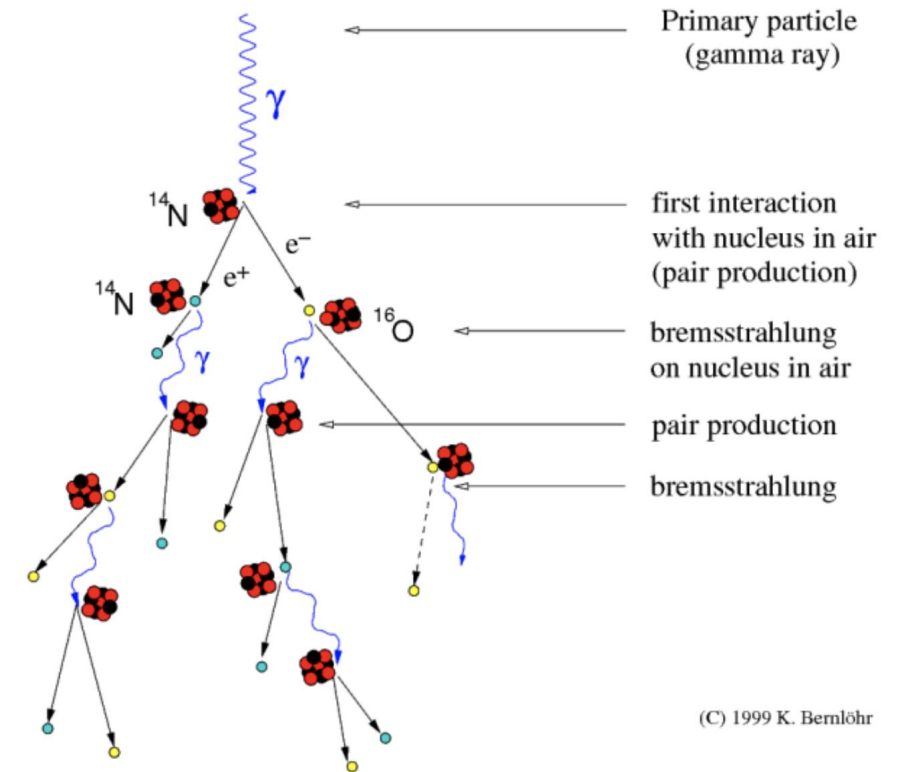

A shower model

Heiter

Only the two dominant interactions are considered: Pair production and Bremsstrahlung

$$\gamma + \text{Nucleus} \rightarrow \text{Nucleus} + e^+ + e^-$$

$$e + \text{Nucleus} \rightarrow \text{Nucleus} + e + \gamma$$



Shower development steered by X_0 :

- After a distance X_0 , the electrons (and positrons) remain with only $1/e$ of their initial energy.
- Photons produce a electron/positron pair after travelling $9/7 X_0$

Assumption:

- $E > E_c$: no energy loss due to ionisation or excitation
- $E < E_c$: energy loss is only through ionisation and excitation

Simplification:

- $E_g = E_e = E_0/2$ (electron losses half of the energy)
- $E_e = E_0/2$ (energy shared by electron and positron)

A shower model

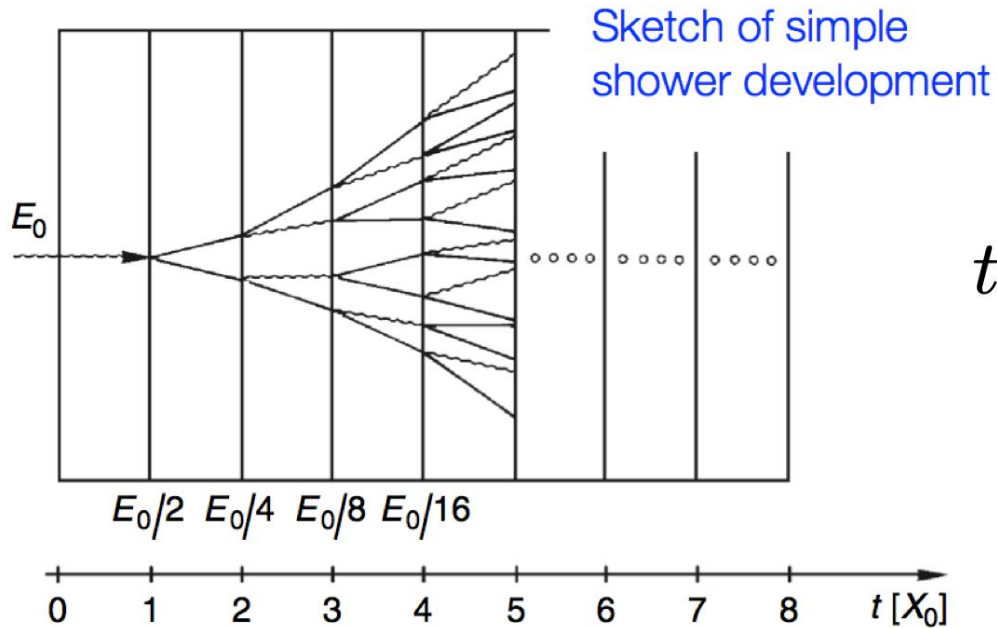

$$t = \frac{x}{X_0}$$

$$N(t) = 2^t$$

$$N(E_0, E_1) = 2^{t_1} = 2^{\log_2(E_0/E_1)}$$

$$N(E_0, E_c) = N_{\max} = 2^{t_{\max}}$$

$$E = \frac{E_0}{N(t)} = E_0 \cdot 2^{-t}$$

$$t = \log_2(E_0/E)$$

The shower is characterised by:

- Number of particles in shower
- Locations of shower maximum
- Longitudinal shower distribution
- Transversal shower distribution

The first 3 are longitudinal components, we measure it in Radiation length

Longitudinal Profile

Being more precise, dE/dx is not constant over the longitudinal development (neither for different energies, although similar shape)

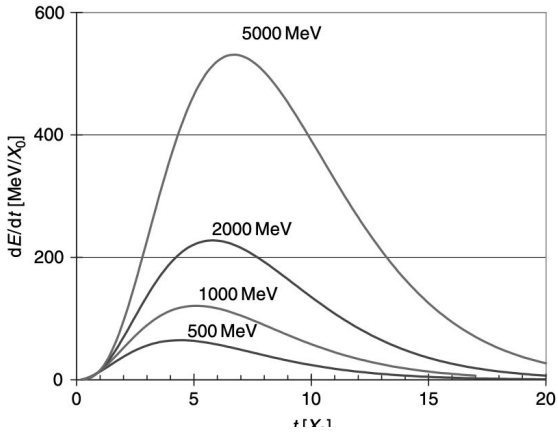

$$\frac{dE}{dt} = E_0 t^\alpha e^{-\beta t} \quad E = 2 \text{ GeV} \rightarrow \alpha = 2 ; \beta = 0.5$$

- At small depth number of secondaries increases
- At larger depth absorption dominates

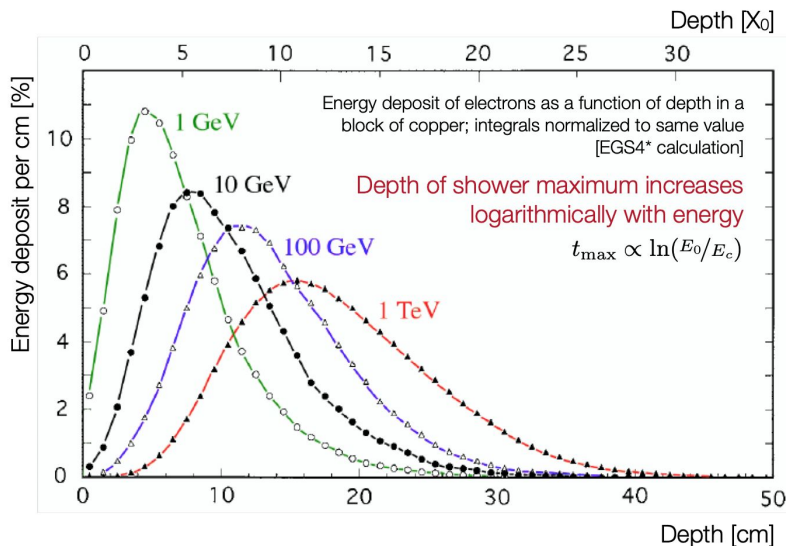

$$\frac{dE}{dt} = E_0 \cdot \beta \cdot \frac{(\beta t)^{\alpha-1} e^{-\beta t}}{\Gamma(\alpha)}$$

$$t_{\max} = \ln \left(\frac{E_0}{E_c} \right) + C_{e\gamma}$$

$$C_{e\gamma} = -0.5 \quad [\gamma\text{-induced}]$$

$$C_{e\gamma} = -1.0 \quad [e\text{-induced}]$$

Transverse Profile

Not only the longitudinal dimensions are relevant, also the transverse dimension:

- Opening angle
- Multiple scattering

Opening Angle Small contribution since $me \ll Ec$ $\langle \theta^2 \rangle \approx (m/E)^2 = 1/\gamma^2$

Pair Production

Bremsstrahlung

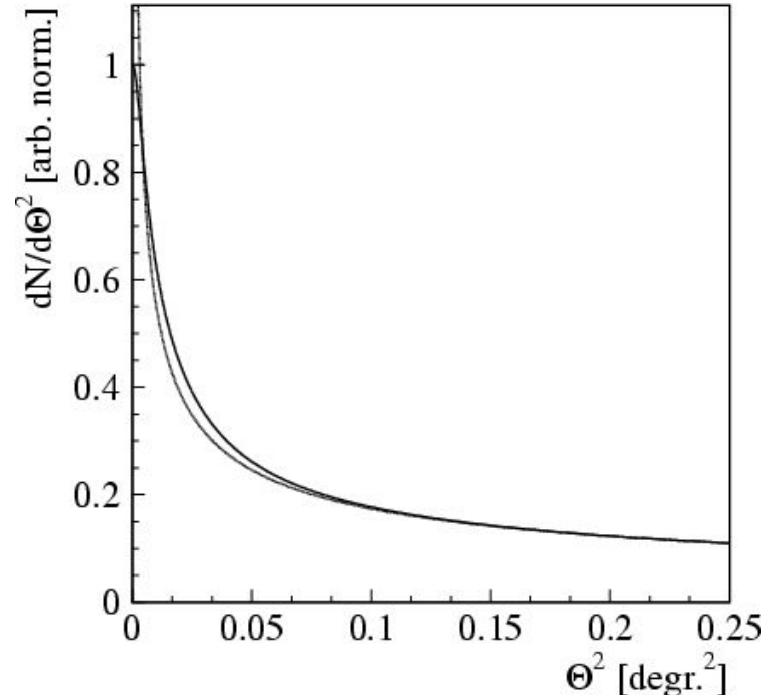

$$\frac{dP_{a\parallel v}}{d\Omega} = \frac{q^2 a^2}{16\pi^2 \varepsilon_0 c^3} \frac{\sin^2 \theta}{(1 - \beta \cos \theta)^5}$$

Transverse Profile

Multiple Scattering

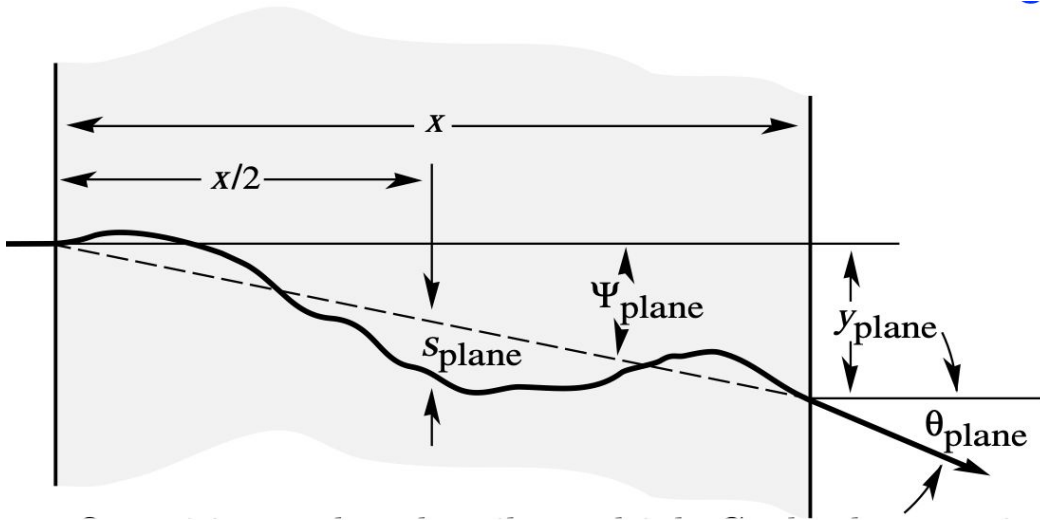

$$\langle \theta_k^2 \rangle = \sum_{m=1}^k \theta_m^2 = k \langle \theta^2 \rangle$$

$$\sqrt{\langle \theta^2 \rangle} \approx \frac{13.6 \text{ MeV}/c}{p} \sqrt{\frac{x}{X_0}} \quad [\beta = 1]$$

The Molière radius is defined as the mean transverse radius of the shower at $x=X_0$ and characterised the lateral shower spread

$$R_M = \langle \theta \rangle_{x=X_0} \cdot X_0 \approx \frac{21 \text{ MeV}}{E_C} X_0$$

Transverse Profile

Parametrization

$$\frac{dE}{dr} = \alpha e^{-r/R_M} + \beta e^{-r/\lambda_{\min}}$$

α, β : free parameters

R_M : Molière radius

λ_{\min} : range of low energetic photons ...

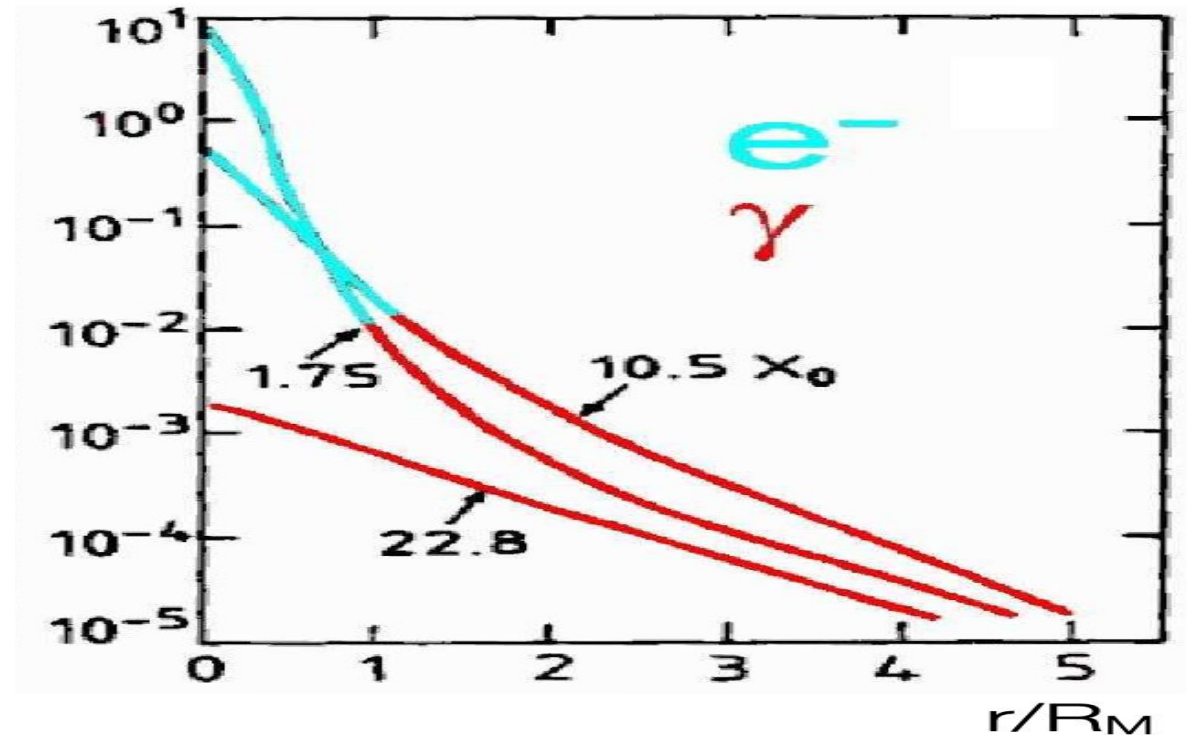

- Inner part: Coulomb Scattering
Electrons and positrons move away from shower axis due to multiple scattering
- Outer part: low energy photons
Photon (and electrons) produces in isotropic process (Compton scattering, photo-electric effect) move away from shower axis (predominant beyond shower maximum)

Electromagnetic Shower

Radiation length:

$$X_0 = \frac{180A}{Z^2} \frac{\text{g}}{\text{cm}^2}$$

Critical energy:

$$E_c^{\text{Gas}} = \frac{710 \text{ MeV}}{Z + 0.92} \quad E_c^{\text{Sol/Liq}} = \frac{610 \text{ MeV}}{Z + 1.24}$$

Shower maximum:

$$t_{\text{max}} = \ln \frac{E}{E_c} - \begin{cases} 1.0 & e^- \text{ induced shower} \\ 0.5 & \gamma \text{ induced shower} \end{cases}$$

Longitudinal energy containment:

$$L(95\%) = t_{\text{max}} + 0.08Z + 9.6 [X_0]$$

Transverse Energy containment:

$$R(90\%) = R_M \quad R(95\%) = 2R_M \quad R_M = \frac{21 \text{ MeV}}{E_c} X_0$$

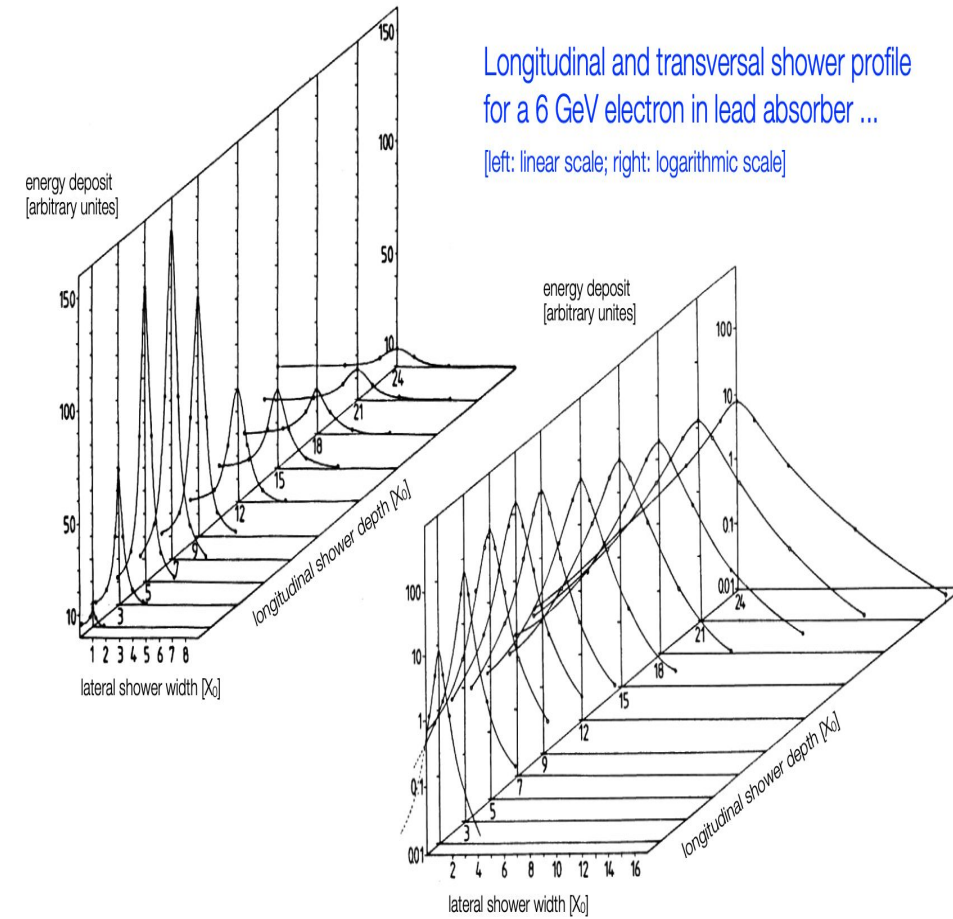

Strong forces

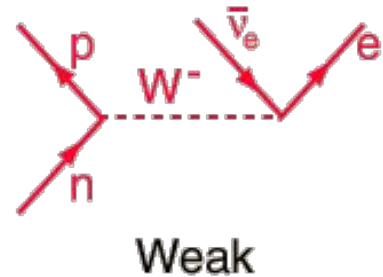
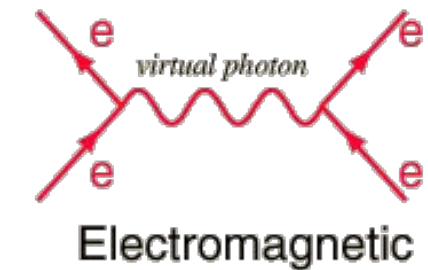

Both proton/neutron as well as atoms will interact also through strong force.

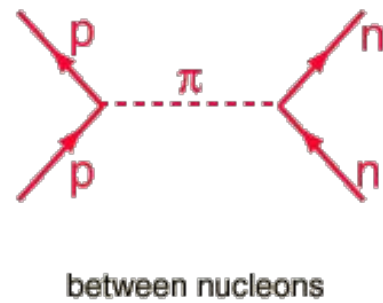
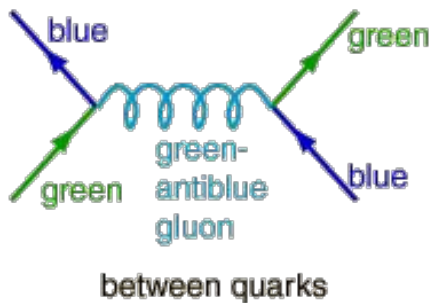

Strong Interaction

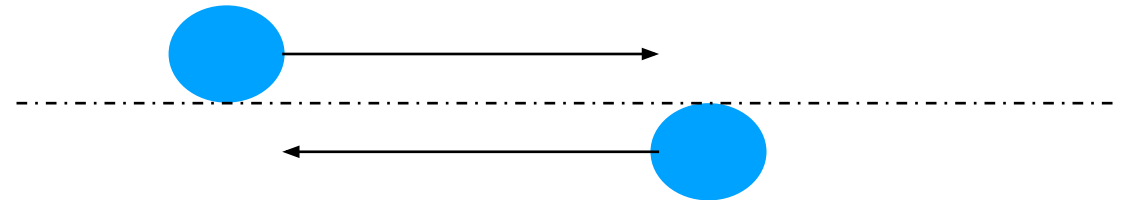

Size of p/n $\sim 1e-13$ cm $\rightarrow \sigma = 4 \cdot 10^{-26} = 40$ mb

Size atom $\sim A^{1/3} R_p$ $\rightarrow \sigma = 4 \cdot 10^{-26} A^{2/3} = 40$ mb

pp Cross Section

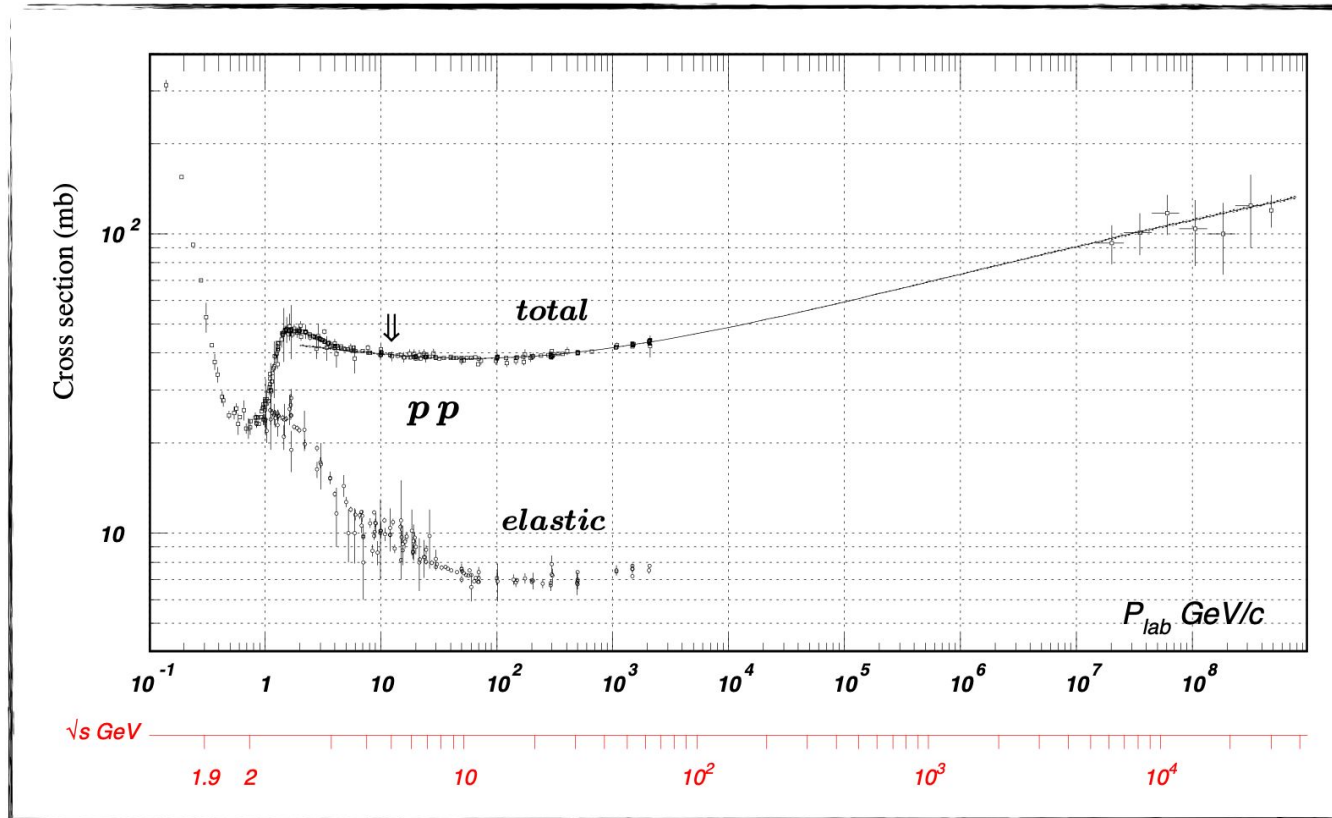

$$\sigma_{\text{tot}} = \sigma_{\text{el}} + \sigma_{\text{inel}}$$

$$\sigma_{\text{el}} \approx 10 \text{ mb}$$

$$\sigma_{\text{inel}} \propto A^{2/3}$$

Dominant at high energies

$$\lambda_{\text{int}} = \frac{1}{\sigma_{\text{tot}} \cdot n} = \frac{A}{\sigma_{pp} A^{2/3} \cdot N_A \rho} \sim A^{1/3}$$

$$\approx 35 \text{ g/cm}^2 \cdot A^{1/3}$$

$$N(x) = N_0 \exp(-x/\lambda_{\text{int}})$$

Hadronic Shower

Shower development:

- $p + \text{Nucleus} \rightarrow \pi + \text{Nucleus} + \dots$
- Secondary particles until π production threshold
- Sequential decays:

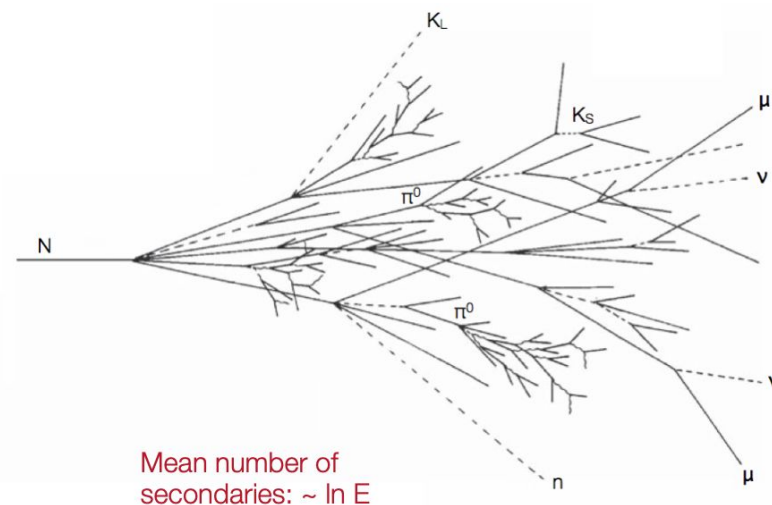

- Mean number of secondaries, $\ln E$
- Significant variation shower to shower
- Large transversal momentum
- Several sub-showers
- Significant electromagnetic component

Cascade energy distribution:

[Example: 5 GeV proton in lead-scintillator calorimeter]

Ionization energy of charged particles (p, π, μ)	1980 MeV [40%]
Electromagnetic shower (π^0, η^0, e)	760 MeV [15%]
Neutrons	520 MeV [10%]
Photons from nuclear de-excitation	310 MeV [6%]
Non-detectable energy (nuclear binding, neutrinos)	1430 MeV [29%]

Still, the interaction length characterise the longitude and transversal length of the shower

A shower model

Energy in depth t :

$$E(t) = \frac{E}{\langle n \rangle^t} \quad \& \quad E(t_{\max}) = E_{\text{thr}}$$

[with $E_{\text{thr}} \approx 290 \text{ MeV}$]

$$E_{\text{thr}} = \frac{E}{\langle n \rangle^{t_{\max}}}$$

Shower maximum:

$$\langle n \rangle^{t_{\max}} = \frac{E}{E_{\text{thr}}}$$

$$t_{\max} = \frac{\ln(E/E_{\text{thr}})}{\ln \langle n \rangle}$$

Depth (in units of λ_{int}):

$$t = \frac{x}{\lambda_{\text{int}}}$$

But, this is a very simple model:

- Energy sharing between shower particles fluctuates
- Part of the energy non detectable (neutrinos, binding energy)
- Spatial distribution varies strongly
- Electromagnetic fraction increases logarithmically with energy
- Hadronisation (with $E_c \sim 1 \text{ GeV}$)

The shower needs to be simulated using Monte Carlo techniques

Longitudinal Profile

Being more precise, dE/dx is not constant over the longitudinal development (neither for different energies, although similar shape)

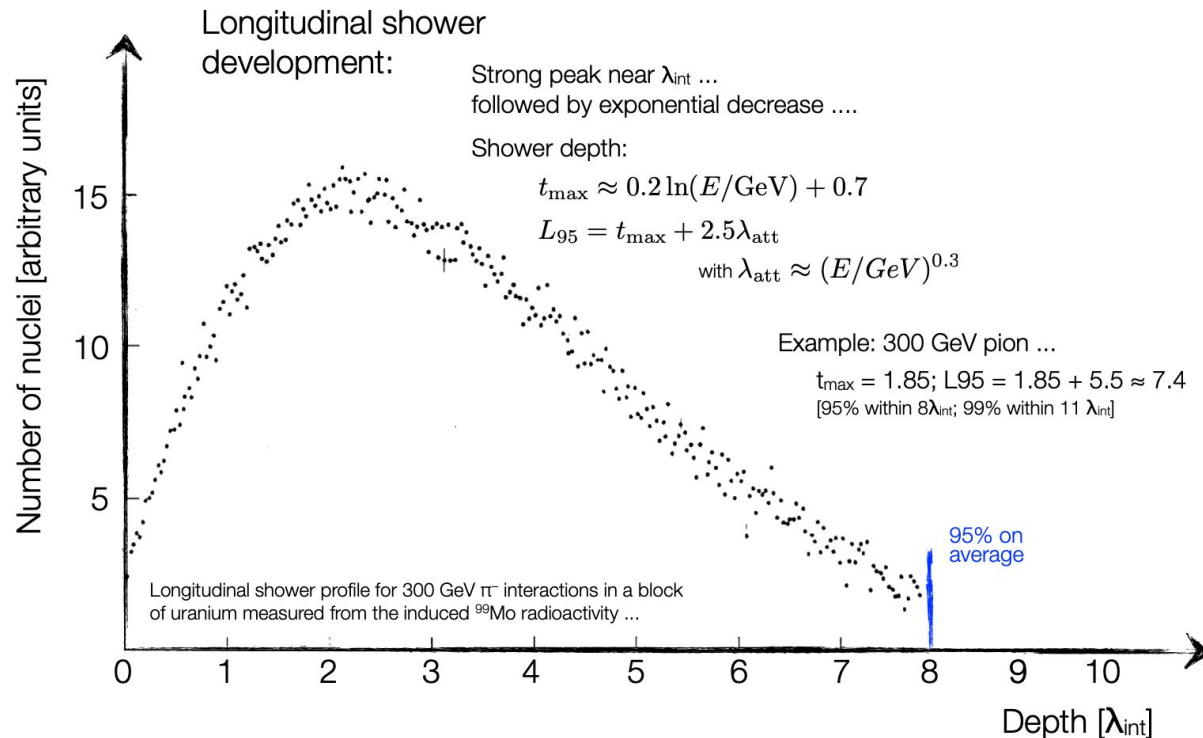

- Strong peak near Interaction length, followed by exponential decrease
- Shower depth

$$t_{\text{max}} \approx 0.2 \ln(E/\text{GeV}) + 0.7$$

$$L_{95} = t_{\text{max}} + 2.5\lambda_{\text{att}}$$

$$\text{with } \lambda_{\text{att}} \approx (E/\text{GeV})^{0.3}$$

Transverse Profile

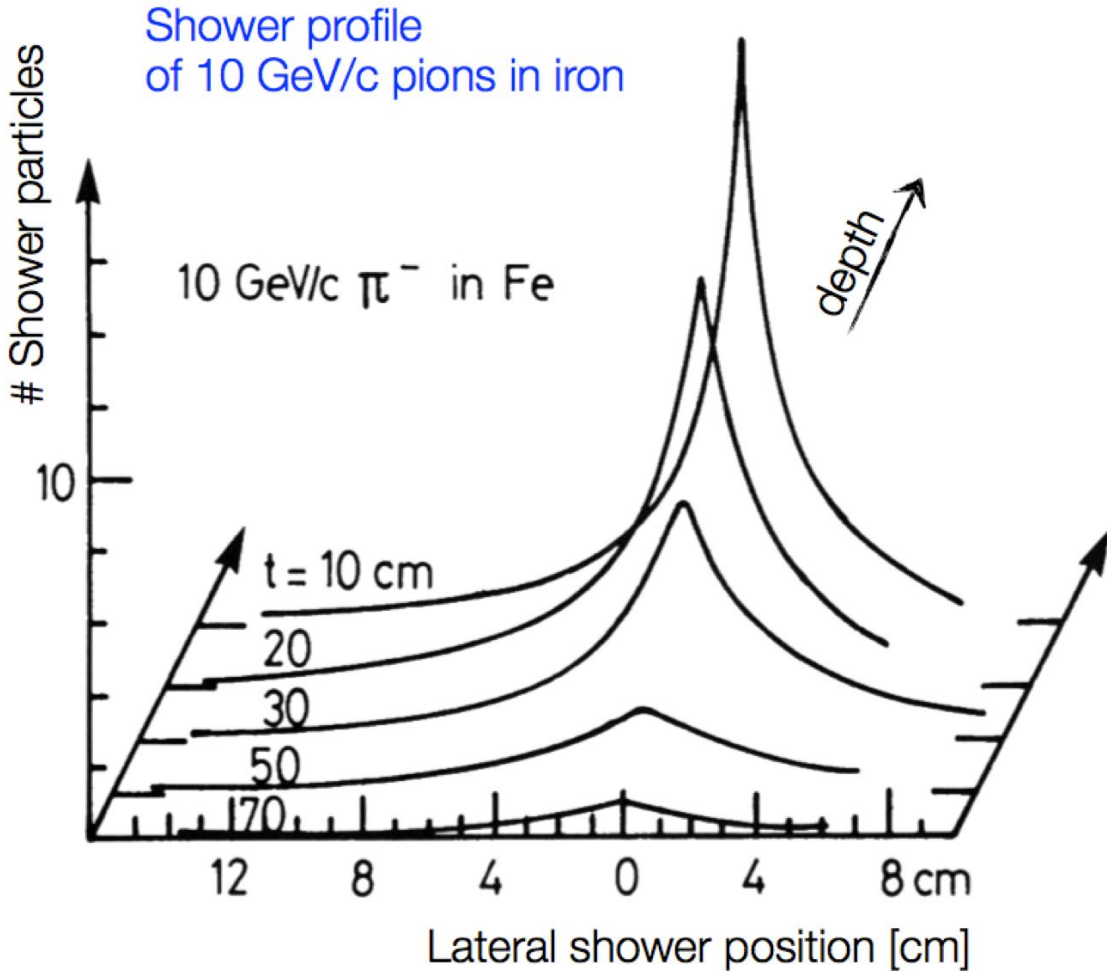

- Typical transverse momentum of secondaries: 350 MeV/c
- Lateral extension at shower maximum \sim Interaction Length
- Electromagnetic component leads to “well” defined core (Molière Radius)
- Exponential decay after shower maximum

Hadronic/Electromagnetic

$$\left. \begin{aligned} X_0 &\sim \frac{A}{Z^2} \\ \lambda_{\text{int}} &\sim A^{1/3} \end{aligned} \right\} \rightarrow \frac{\lambda_{\text{int}}}{X_0} \sim A^{4/3}$$

	λ_{int} [cm]	X_0 [cm]
Scint	79.4	42.2
LAr	83.7	14.0
Fe	16.8	1.76
Pb	17.1	0.56
U	10.5	0.32
C	38.1	18.8

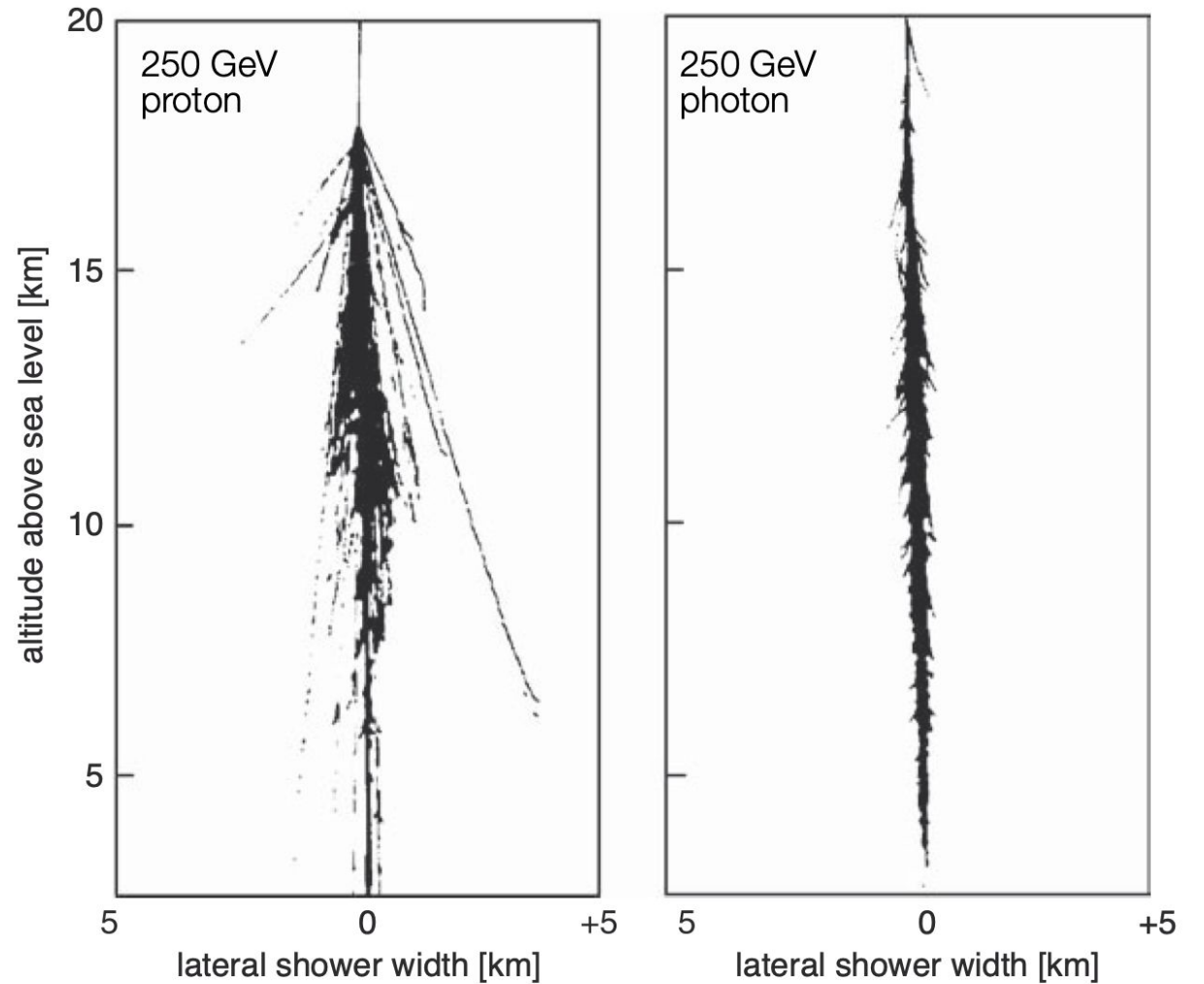

Imaging Air Cherenkov Technique

Cherenkov Radiation

- Emitted whenever a charged particle traverses a medium at a speed larger than that of light in the medium
- The radiation results from the **reorientation of electric dipoles** induced by the charge in the medium. When $v > c/n$ the contributions from different points of the trajectory arrive in phase at the observer as a **narrow light pulse**

$$\cos \theta = 1 / (\beta n)$$

$$\theta_{\max} = \cos^{-1}(1/n)$$

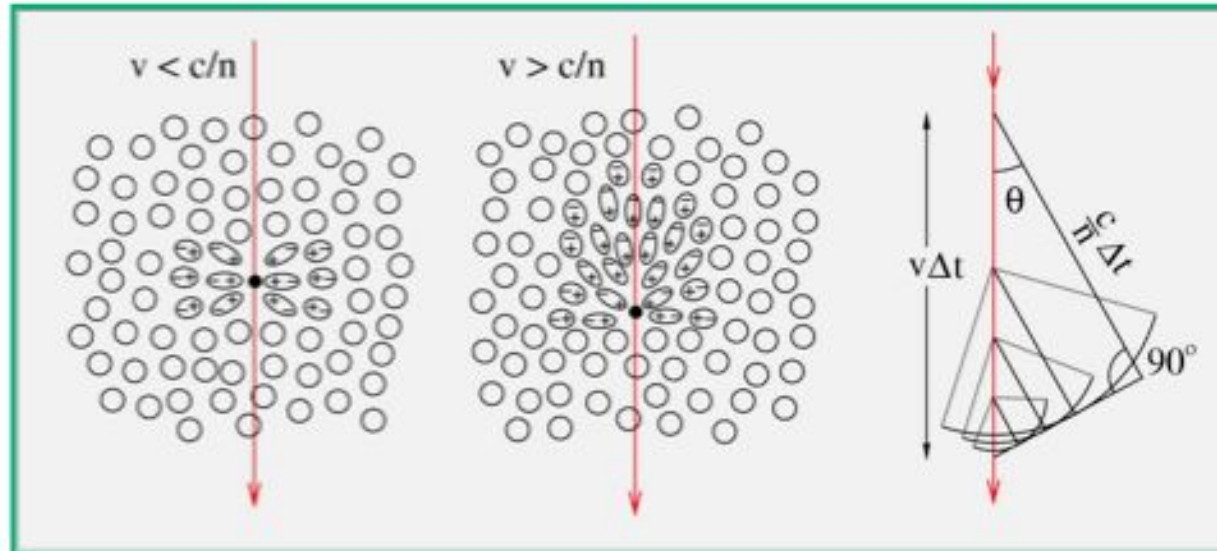
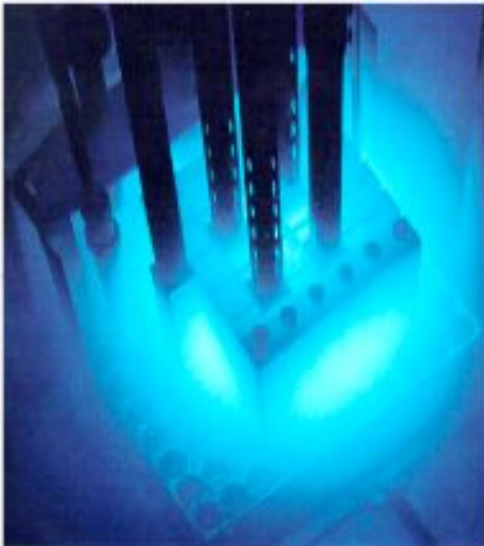

Some of the processes at the Relativistic Rise

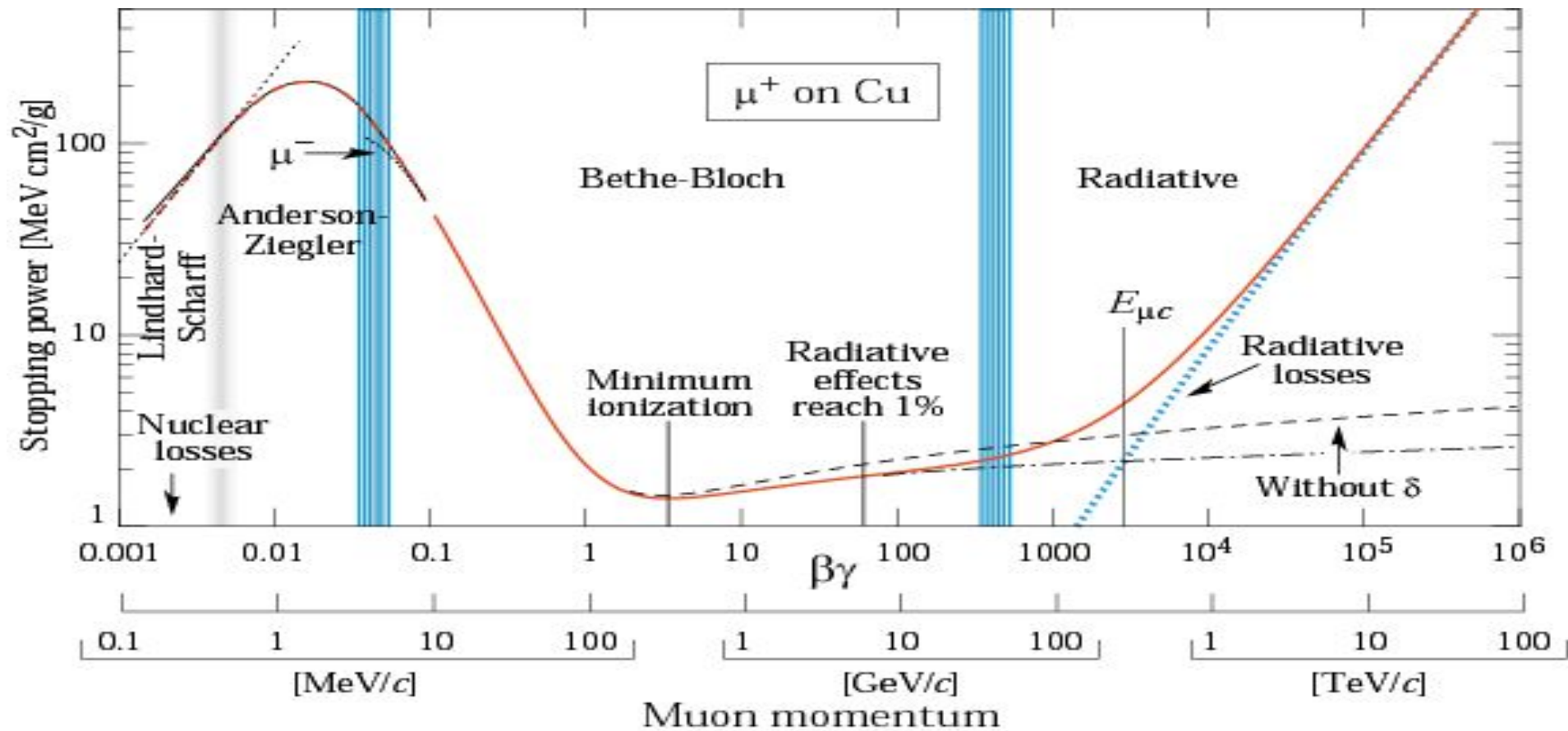

The density effect in the energy loss is intimately connected to the coherent response of a medium to the passage of a relativistic particle that causes the emission of Cherenkov radiation.

Cherenkov Radiation with a classic twist:

A charged particle with velocity β $\beta=v/c$
 in a medium with refractive index n $n=n(\lambda)$
 may emit light along a conical wave front.

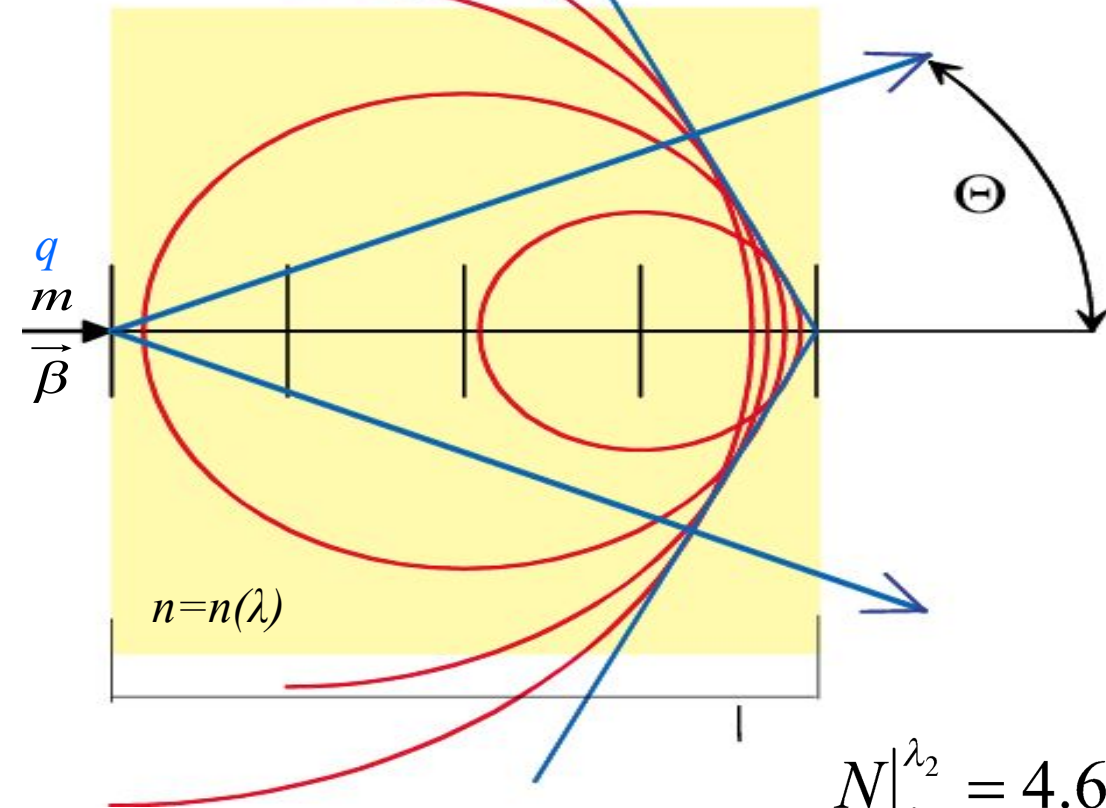

The angle of emission is given by:

$$\cos \Theta = \frac{1}{\beta * n(\lambda)}$$

and the number of photons by:

$$\frac{dN}{d\lambda} = N_0 \cdot l \cdot \frac{\sin^2 \Theta}{\lambda^2}$$

$$N \Big|_{\lambda_1}^{\lambda_2} = 4.6 \cdot 10^6 \cdot \left[\frac{1}{\lambda_2(A)} - \frac{1}{\lambda_1(A)} \right] \cdot l(cm) \cdot \sin^2 \Theta$$

The same, but let us consider how a charged particle interacts with the medium

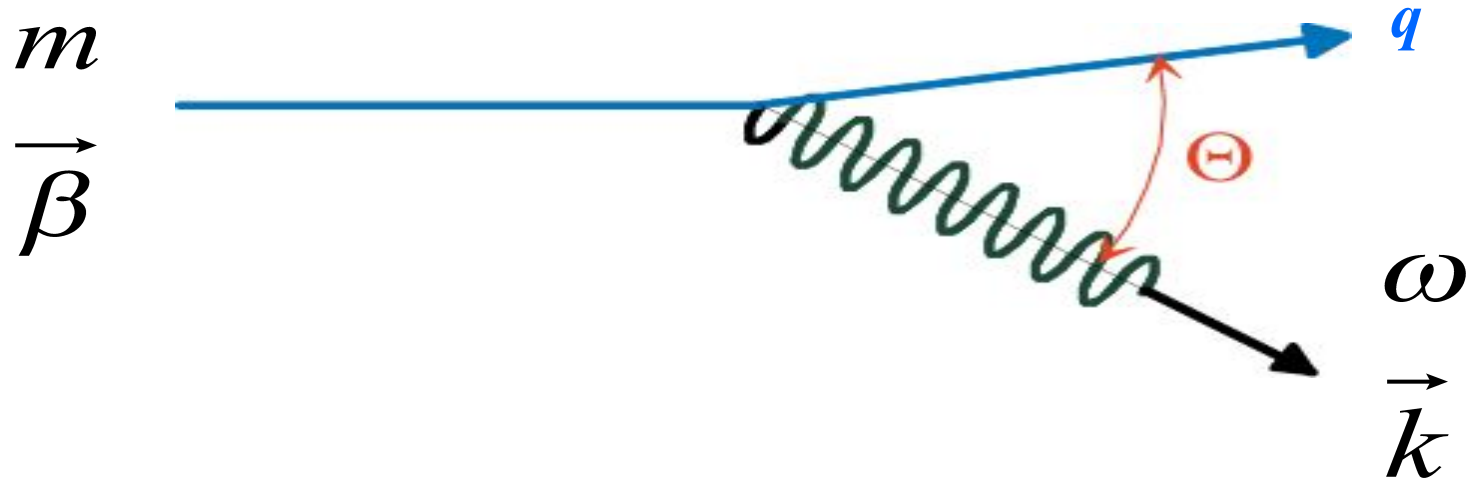

Conservation of energy and momentum

$$\omega = \vec{\beta} \cdot \vec{k}$$

If:
 $\omega \ll \gamma m = E$
 $k \ll \beta \gamma m = p$

The behavior of a photon in a medium is described by the dispersion relation

$$\omega^2 - \frac{k^2}{\epsilon} = 0$$

then:
 $\cos \Theta = \frac{1}{\beta \sqrt{\epsilon}}$

The Cherenkov radiation condition:

ϵ real

and

$$0 \leq \cos(\Theta) \leq 1$$

$$\cos \Theta_C = \frac{1}{\beta \cdot n}$$

where n is the refractive index

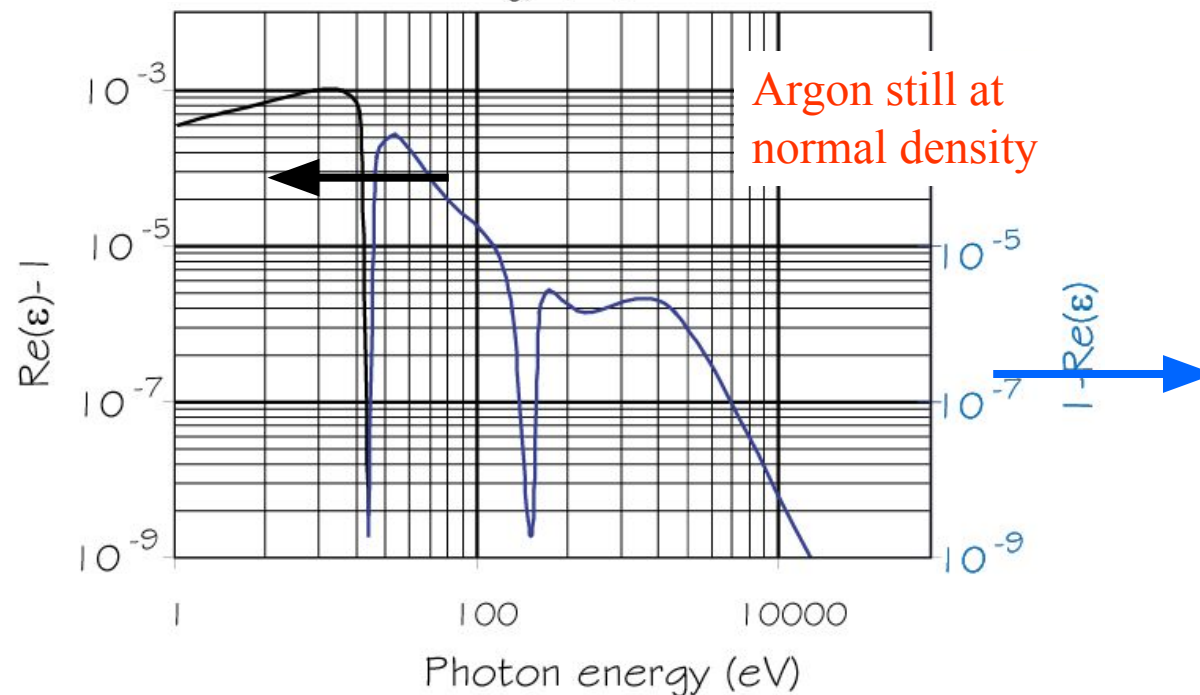
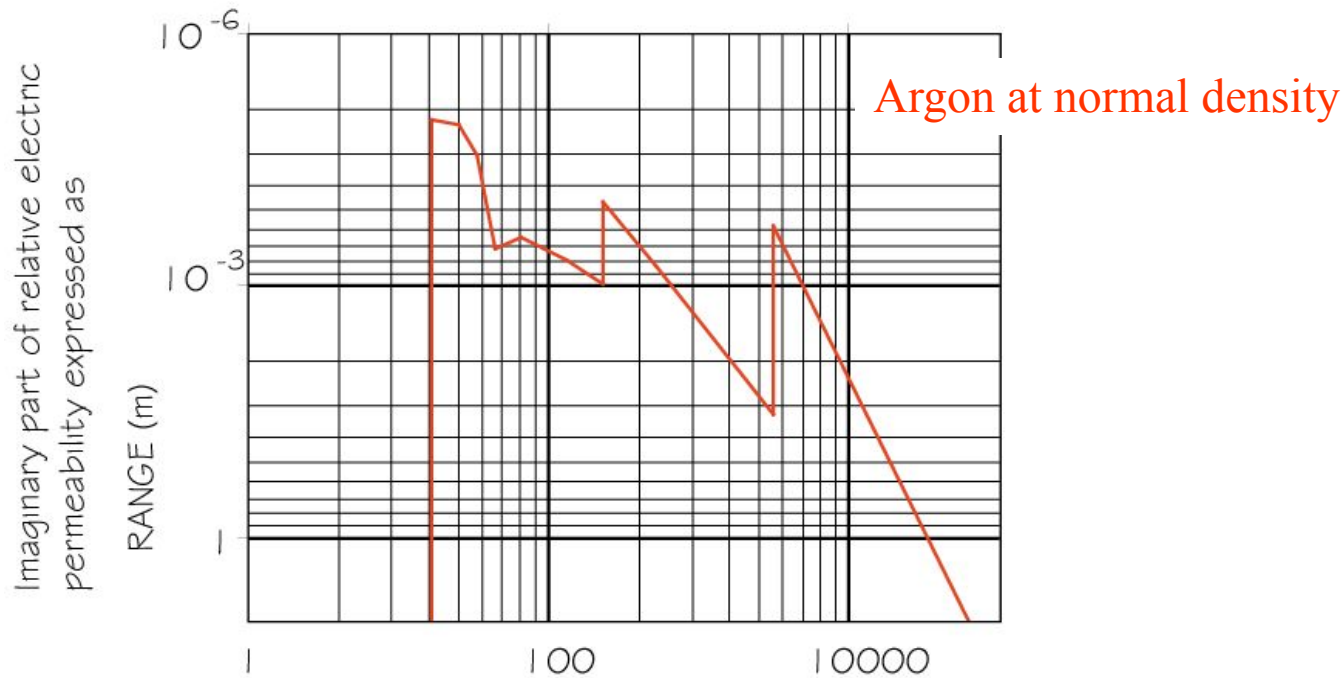

A practical example

$$\cos \theta = \frac{1}{\beta n}$$

$$m = \frac{p}{\beta \gamma}$$

$$\frac{\Delta m}{m} = \sqrt{\left(\frac{\Delta p}{p}\right)^2 + (\gamma^2 \cdot \text{tg} \theta \cdot \Delta \theta)^2}$$

set :
 $n=1.333$ (H₂O)

$\theta_{\text{max}} = 41.4^\circ$
 $\beta_{\text{min}} = 0.75$

$\Delta p/p^2 = 5 \cdot 10^{-4}$
 $\Delta \theta = 15 \text{ mrad}$
 $l = 1 \text{ cm}$

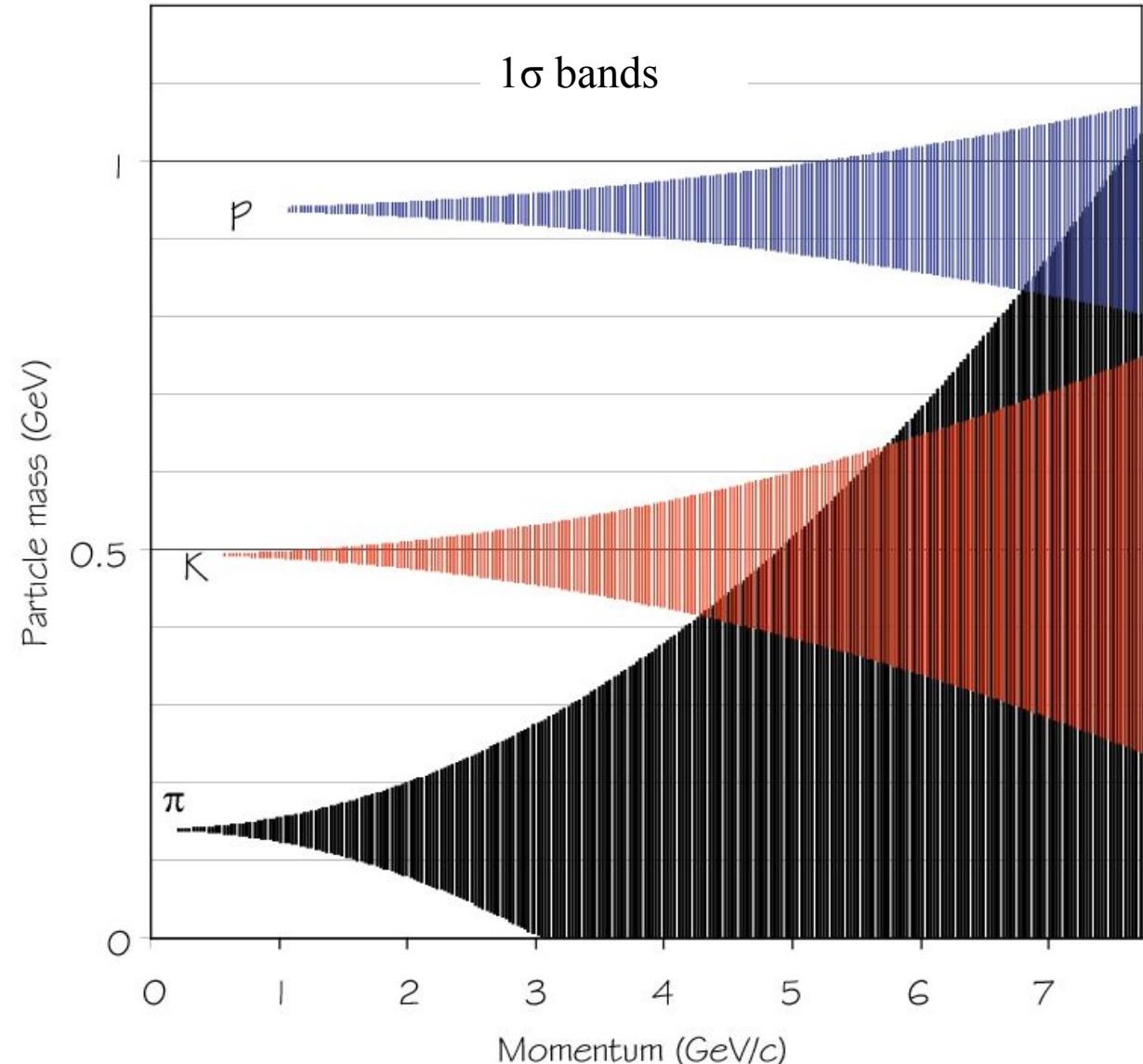

Some words on refractive index

The normal way to express n is as a power series.
 For a simple gas, a simple
 one pole Sellmeier approximation:

$$(n-1) \cdot 10^6 = \frac{0.05085}{\left(\frac{1}{73.8}\right)^2 - \left(\frac{1}{\lambda(nm)}\right)^2}$$

Argon

$$= 16.8 \text{ eV}$$

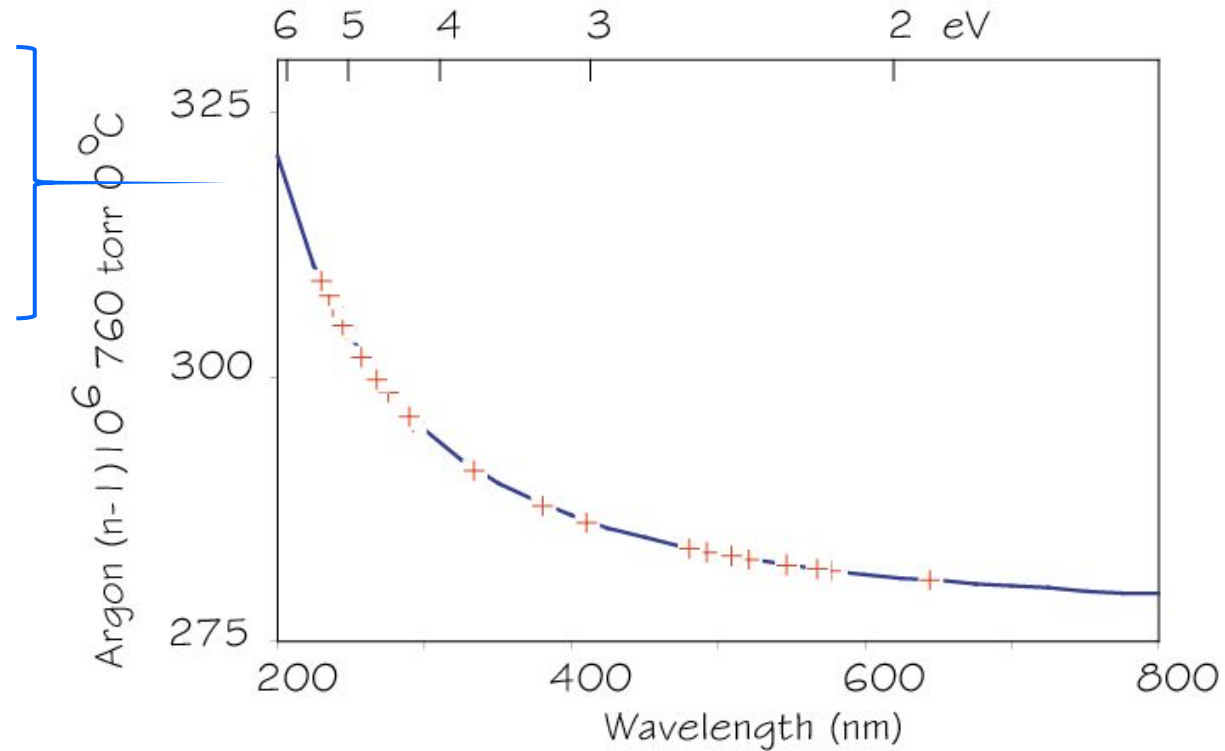

Imaginary part of relative electric permeability expressed as

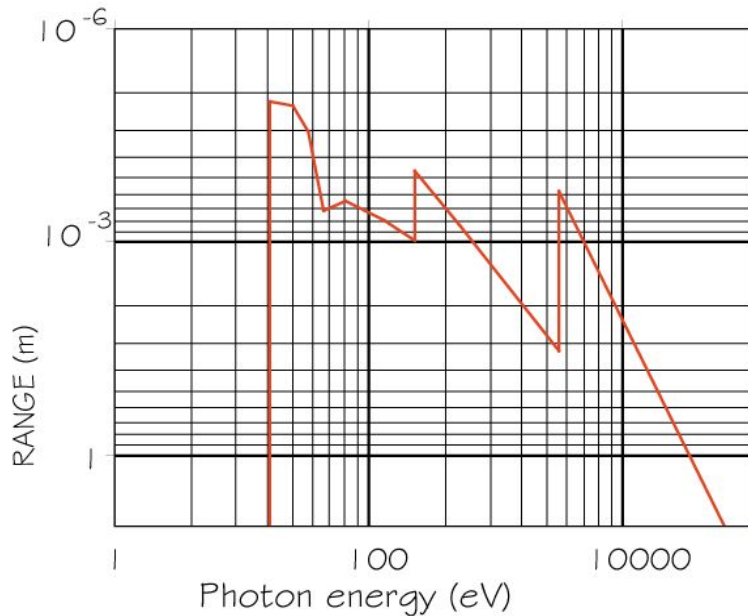

$$\omega_0^2 = (\text{plasma frequency})^2 \propto (\text{electron density})$$

For more on the plasma frequency, try Jackson, Section 7 (or similar)
 or go to sites like
<http://farside.ph.utexas.edu/teaching/plasma/lectures/node44.html>

A step back

$$n - 1 = \frac{A}{\lambda_0^{-2} - \lambda^{-2}}$$

$$\frac{dN_{ph}}{dLdE} = \frac{\alpha Z^2}{\hbar c} \sin^2 \Theta$$

$$\cos \Theta = \frac{1}{\beta n}$$

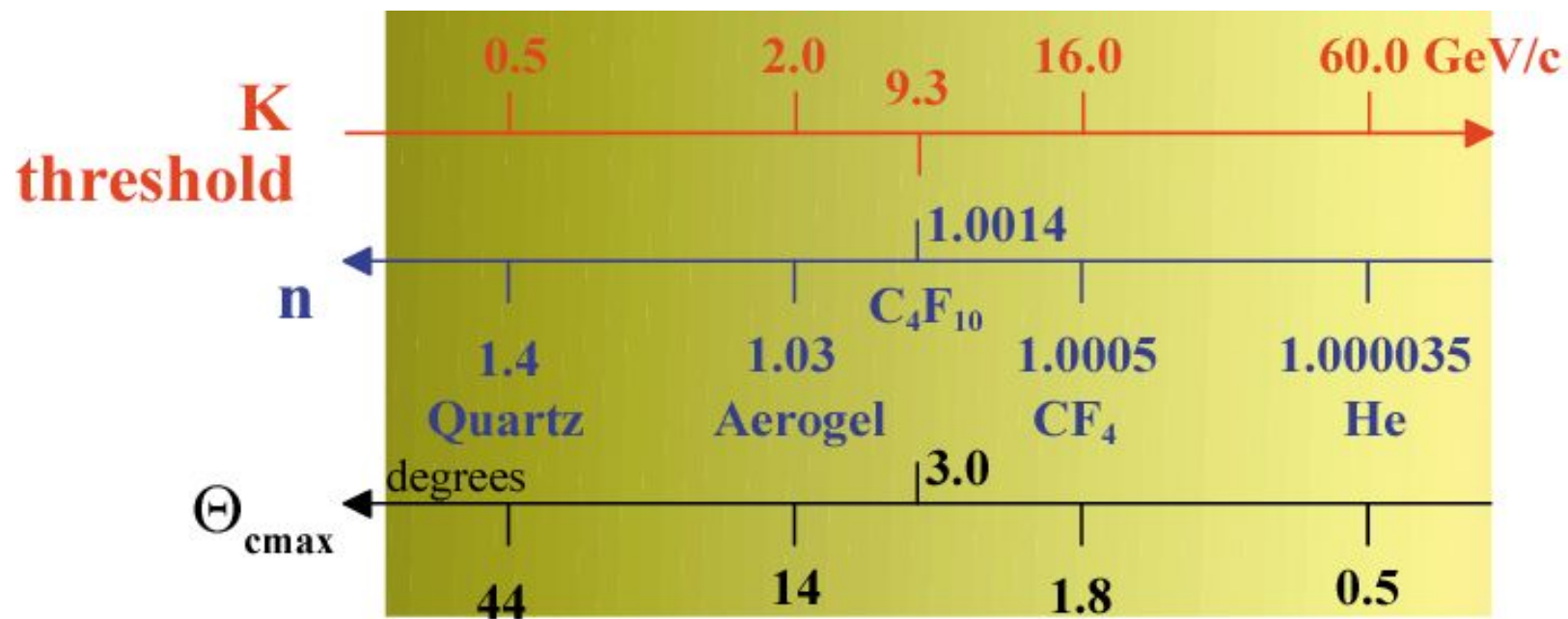
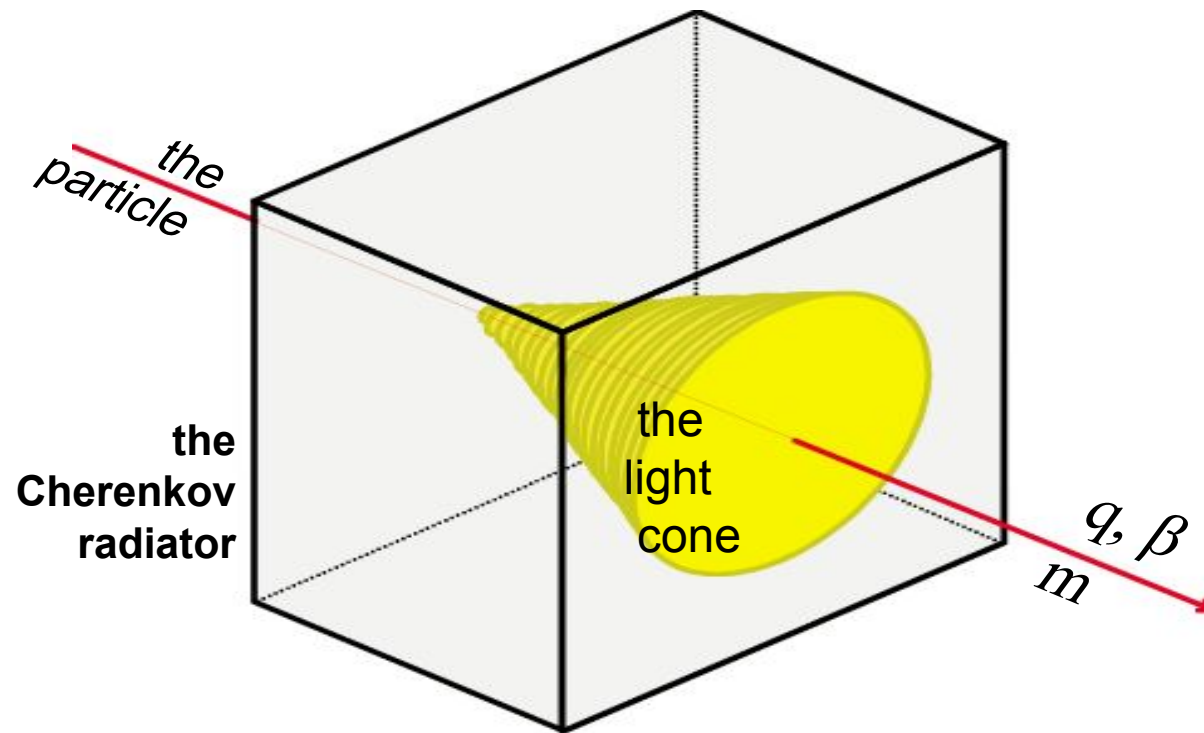

Imaging Air Cherenkov Technique

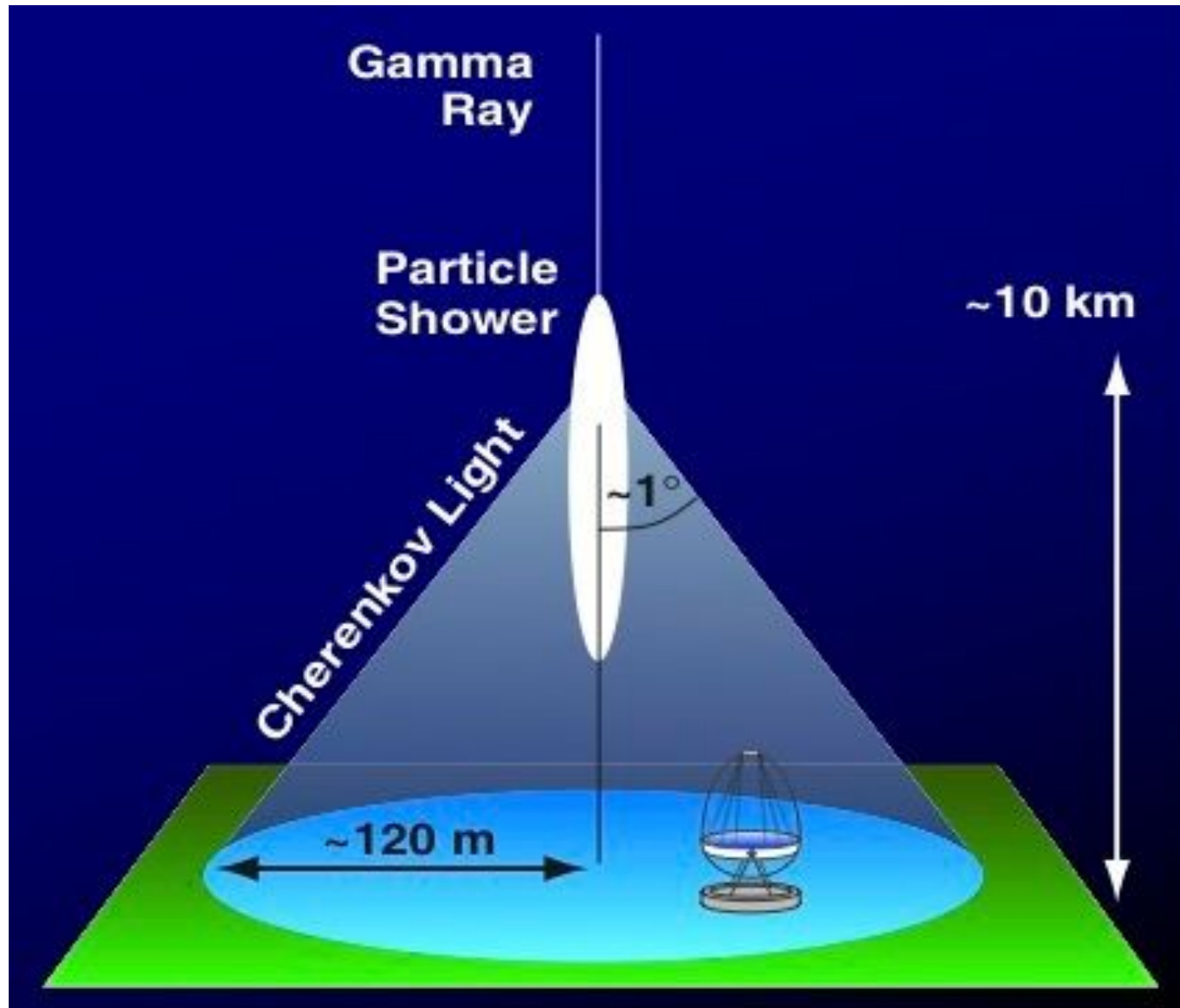

shower axis

head

core

tail

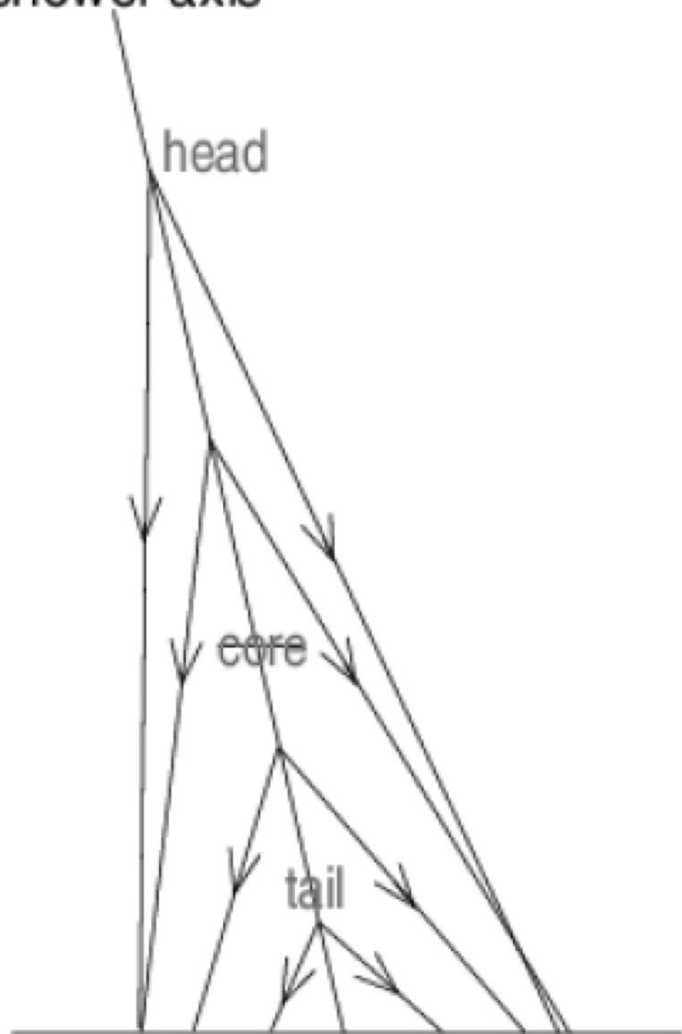

Gamma shower

Camera

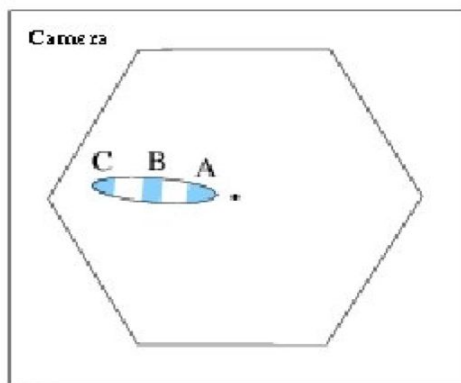

~ 5 km

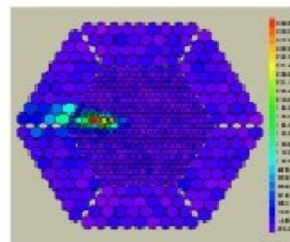

C B A

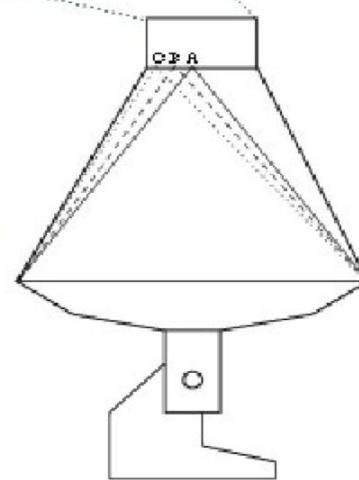

~ 8 km

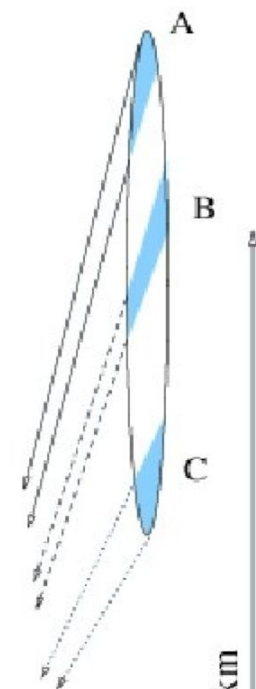

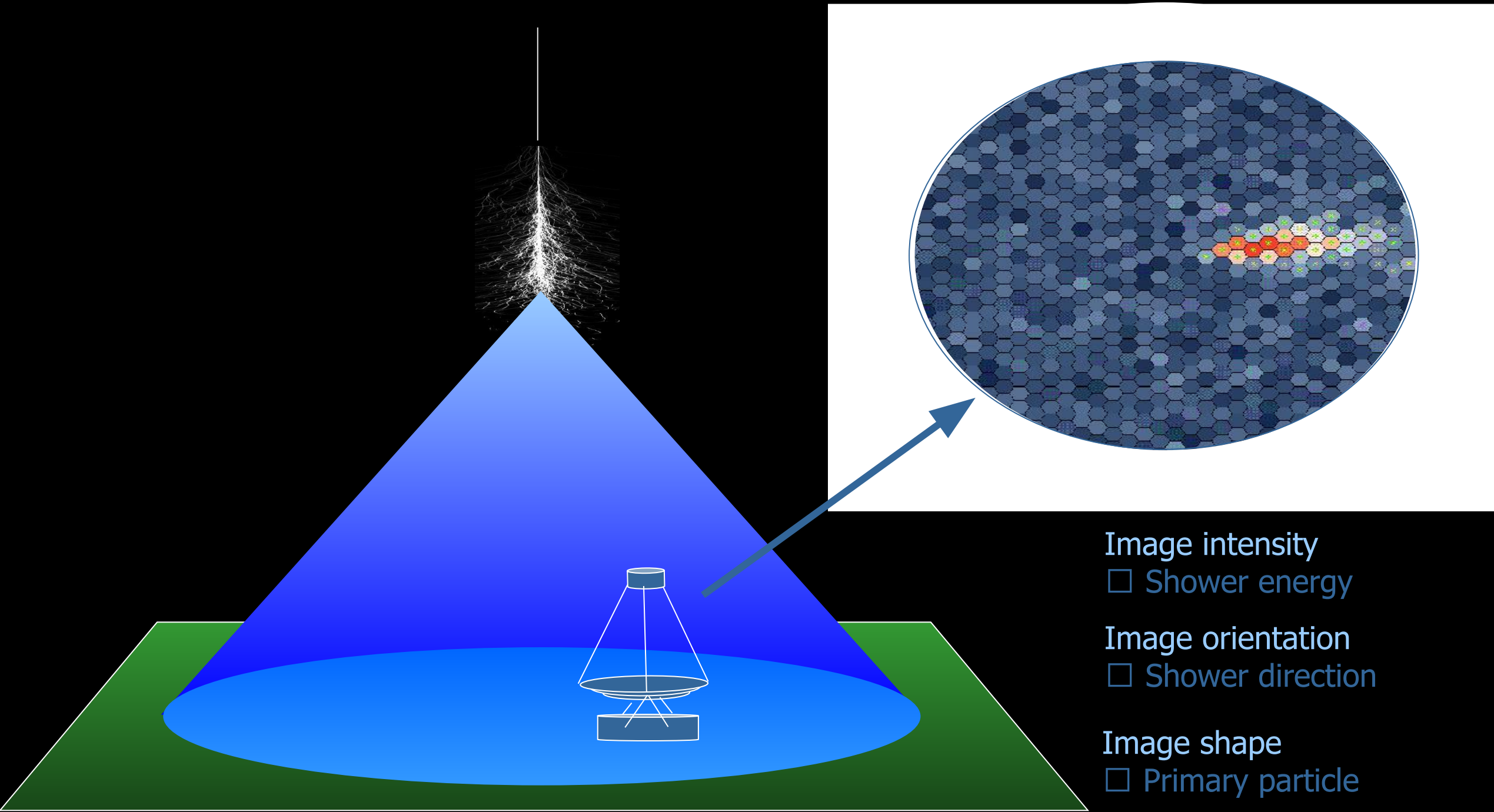

Suppression of charged CR background

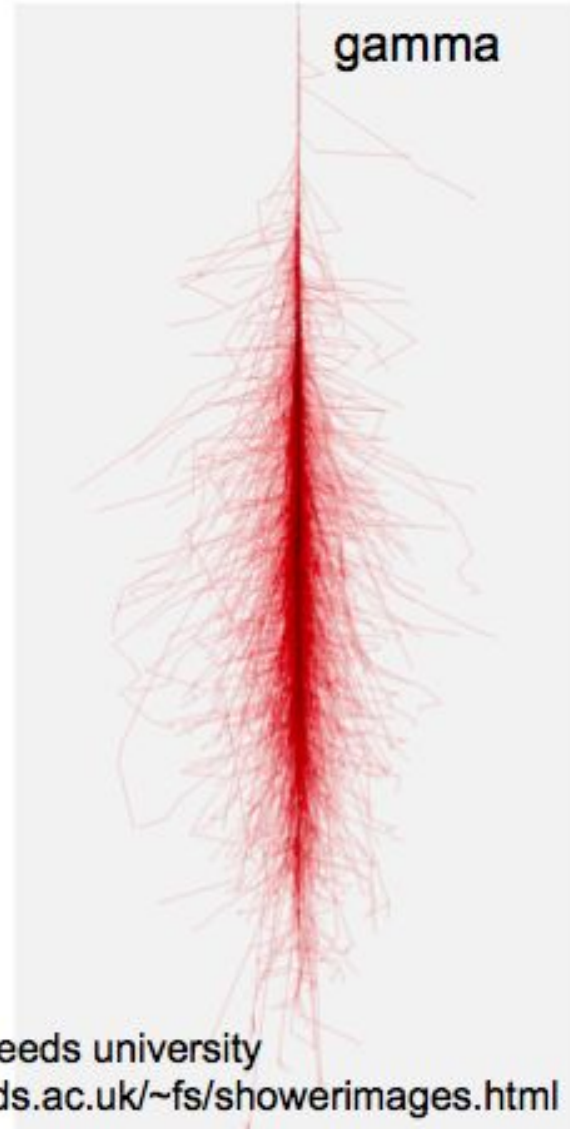
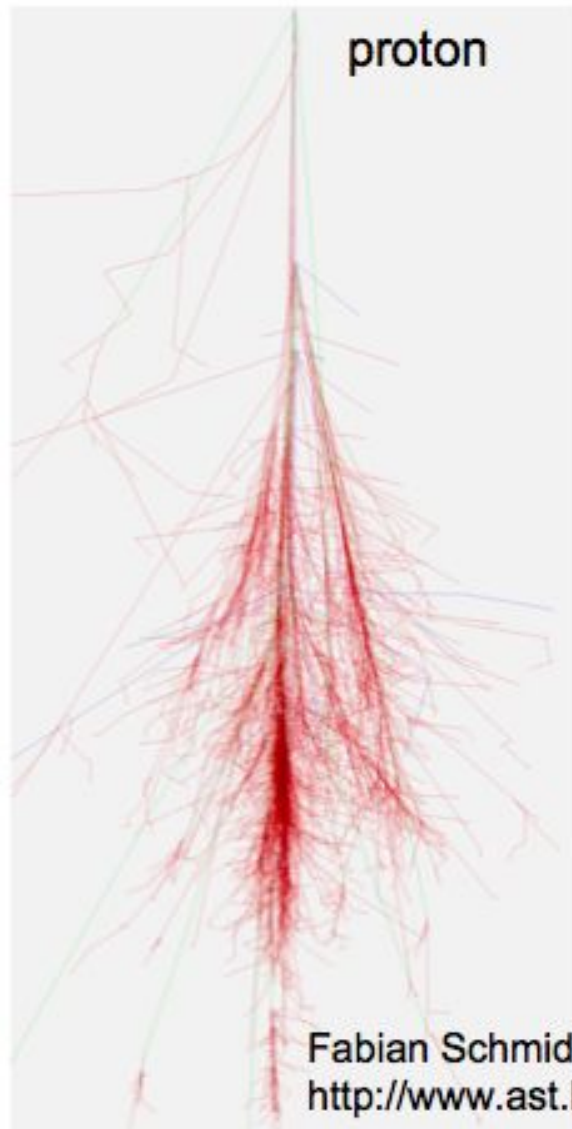

Based on the different **lateral and longitudinal development** of gamma- and hadron- initiated showers

Practical implementation:
Principal component analysis (a.k.a. Hillas parameters)

Gamma-ray like

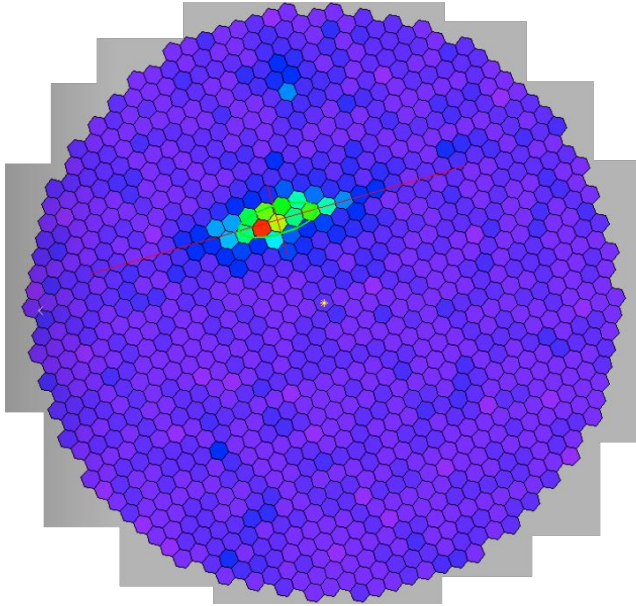

Hadron like

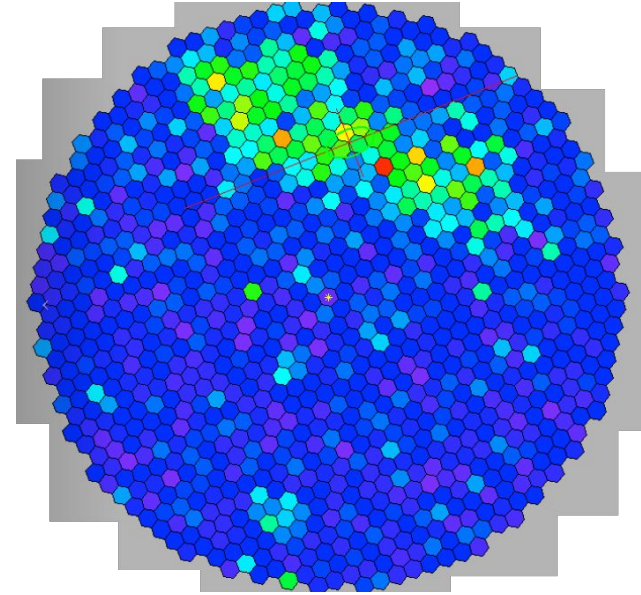

Muon like

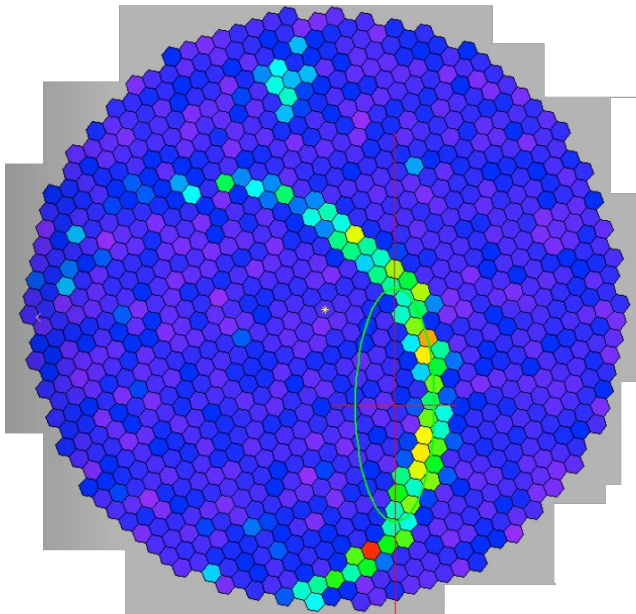

Muon + hadron like

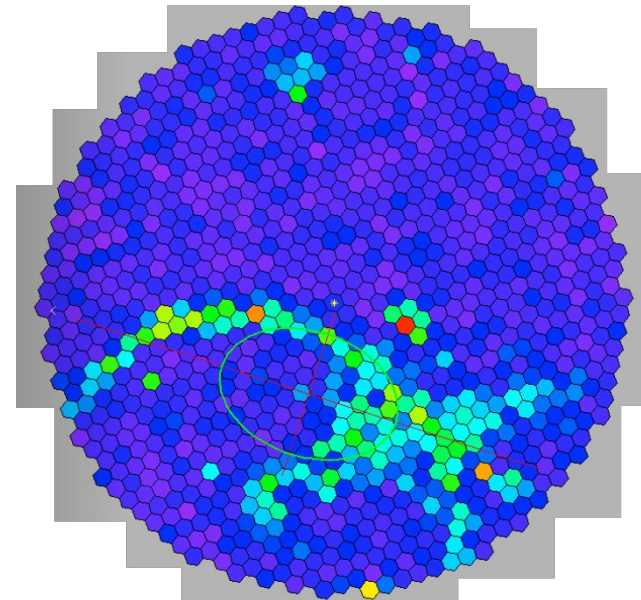

Run 442/ Event 53502, Time 1 ns

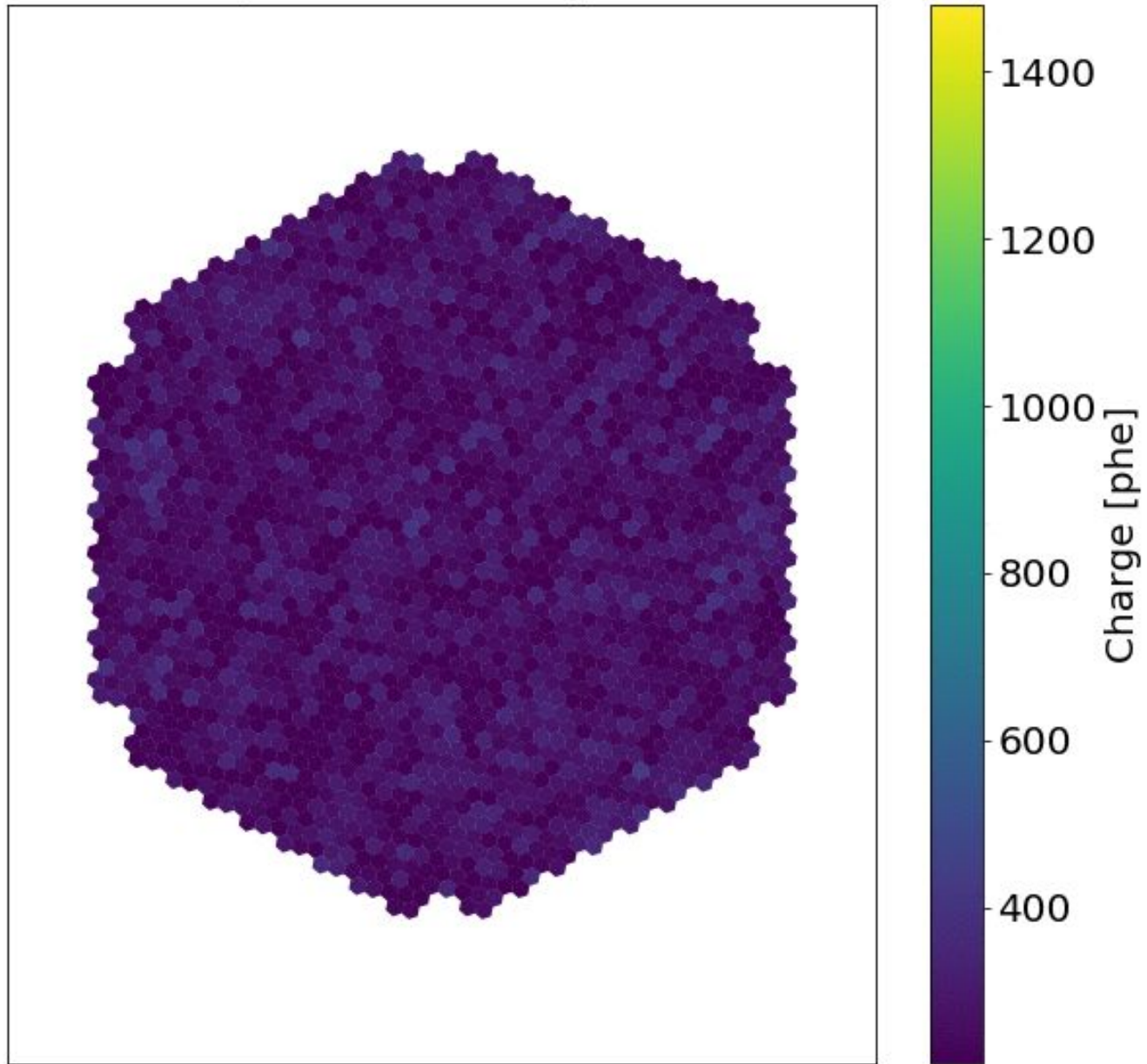

Credit: R. Lopez Coto

Telescopes

Brief history of optical telescopes

- As early as 750 BCE Assyrian made lenses of polished glass (normally quartz). Similar lenses in Egypt, Greece and Babylon. The Romans filled glass spheres with water to make lenses.
- In his *Optics* Euclid (325–265 BCE) observed that "things seen under a greater angle appear greater, and those under a lesser angle less, while those under equal angles appear equal". Euclid investigated the apparent shapes of cylinders and cones when viewed from different angles.
- *Astronomiae Pars Optica*, Johannes Kepler (1604): the inverse-square law governing the intensity of light, reflection by flat and curved mirrors, astronomical implications of optics such as parallax and the apparent sizes of heavenly bodies.
- Willebrord Snell found the mathematical law of refraction in 1621:
 $n_1 \sin \theta_1 = n_2 \sin \theta_2$ (n: refractive index)

Engineering of corrective lenses



The Spectacle Vendor
by Johannes Stradanus, 1582

- Older people start to have problems to read. That's a good market for lens makers.
- Craftsmen in Venice in the 14th century began making small disks of glass, convex on both sides, that could be worn in a frame: spectacles.
- Concave lenses that correct the refractive error known as *myopia* were first made in Italy in the middle of the fifteenth century (~1450!)

Lipperhey

- Hans Lipperhey was born in Germany, but moved to Middelburg (Netherlands).
- Glass-making techniques were introduced here by Italians in the 1590s.
- In 1608 the Dutch States General discussed Lipperhey's application for a patent on a telescope. The patent was denied because it was felt that the device could be easily replicated.

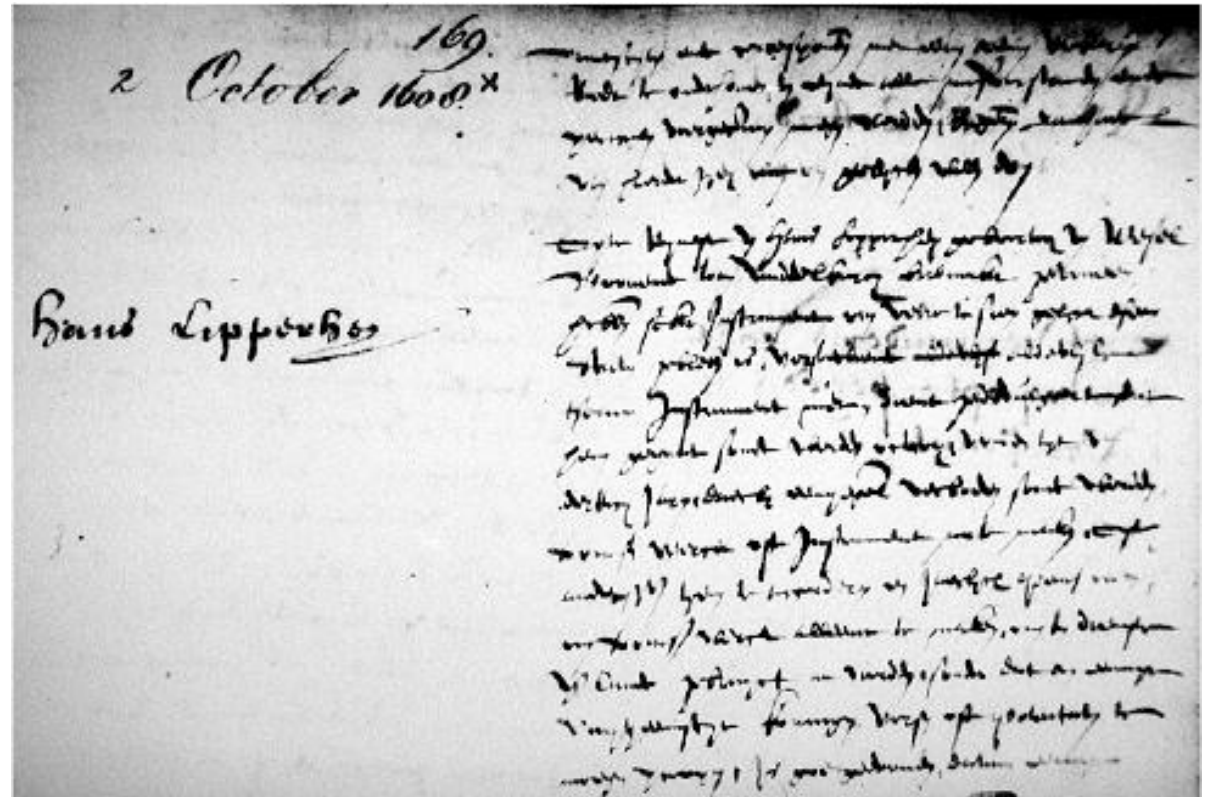

Lipperhey's patent application

Galileo

- The news of this invention spread rapidly through Europe. But it was Galileo Galilei who made the instrument famous.
- He constructed his first 3x amplification telescope in June or July 1609, presented an 8x instrument to the Venetian Senate in August, and turned a 20x instrument to the heavens in October or November.
- With this instrument he observed the Moon, discovered 4 satellites of Jupiter, and resolved nebular patches into stars.
- He published *Sidereus Nuncius* in March 1610.

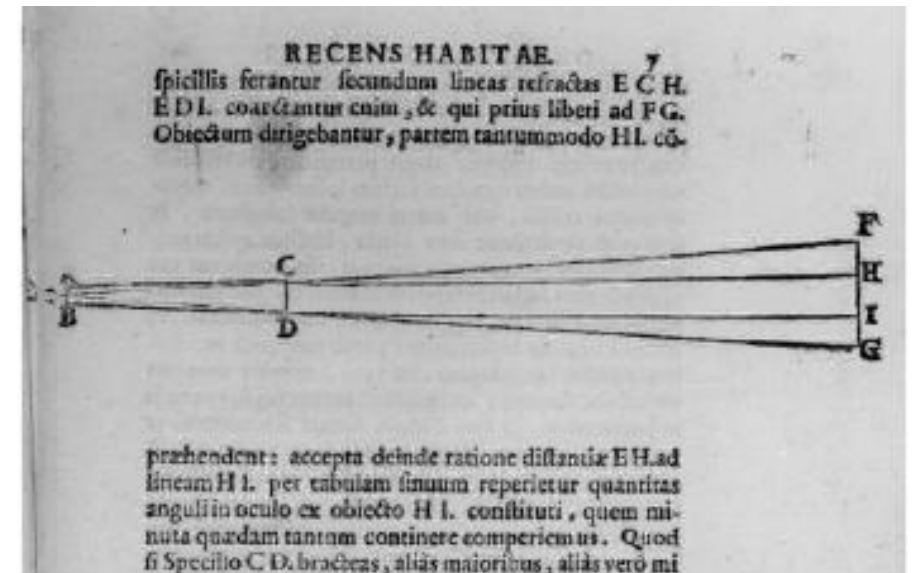

Galileo

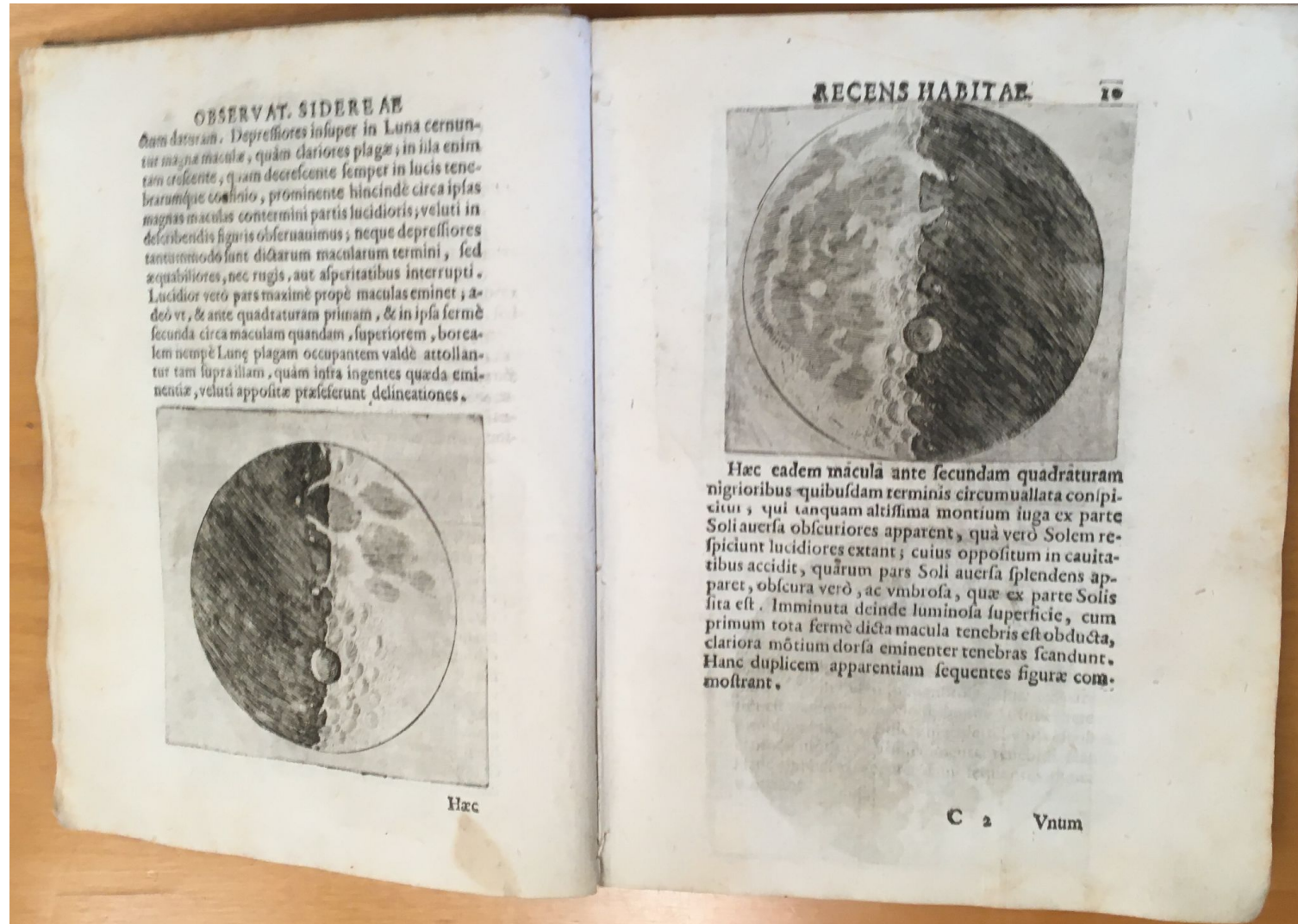

Picture of a copy available at the bibliotheque of the Brera Observatory (Milan)

Galileo's telescope

Convex lens, "Objective", convergent

Concave lens, "Ocular" or "Eyepiece", divergent

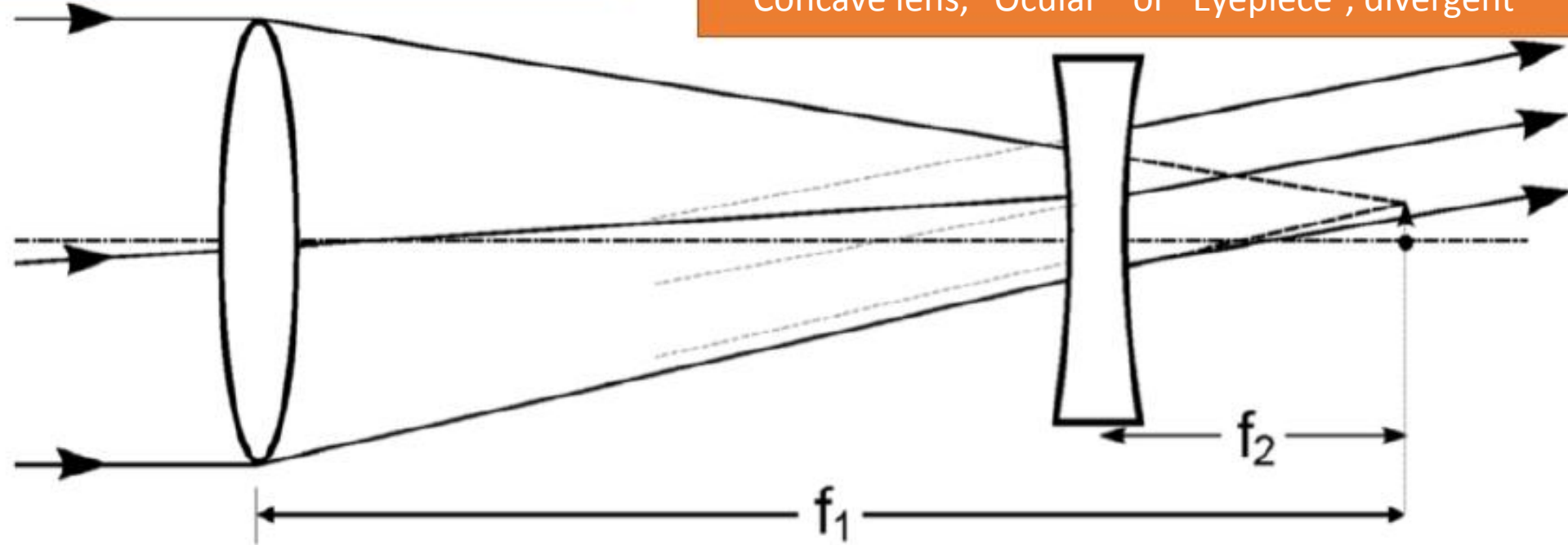

Two lenses: telescopes using lenses are called "refractors"

Galileo's telescope

Convex lens, "Objective", convergent

Concave lens, "Ocular" or "Eyepiece", divergent

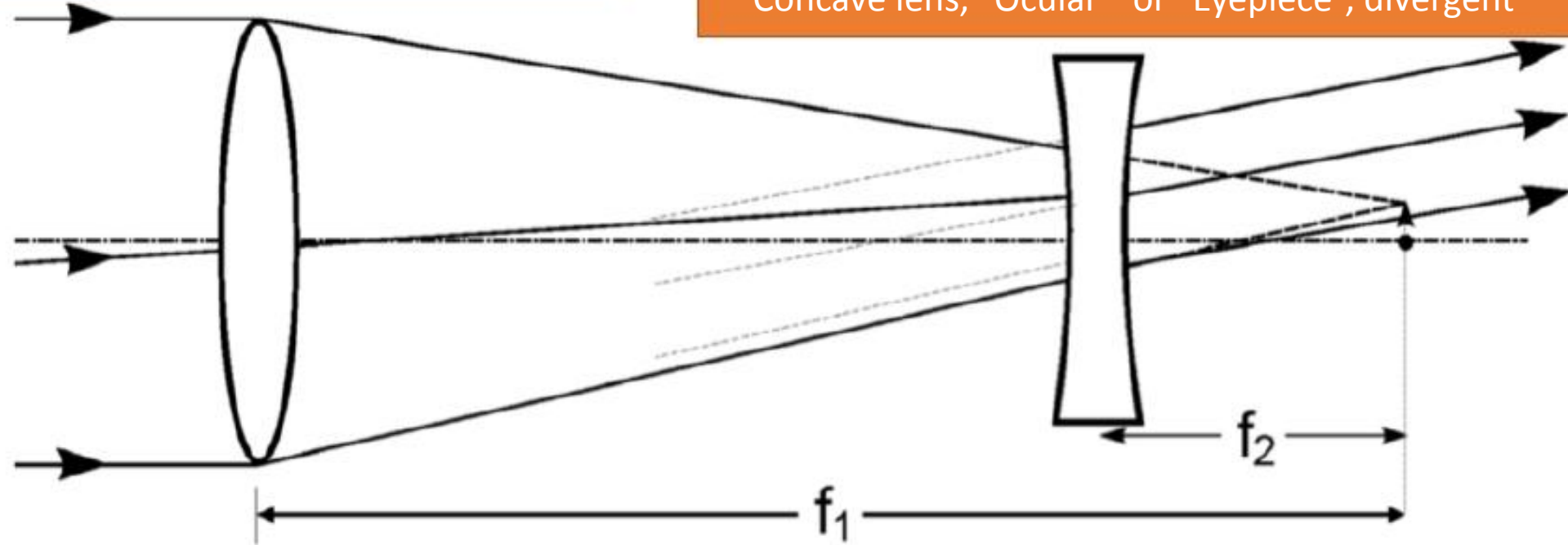

Focal lengths of the lenses are adjusted in position so that incident parallel rays are also parallel at the end.

This is a so-called "afocal" optical system and is meant to couple to your eye.

Even simpler than Galileo's telescope

Convex lens, "Objective", convergent

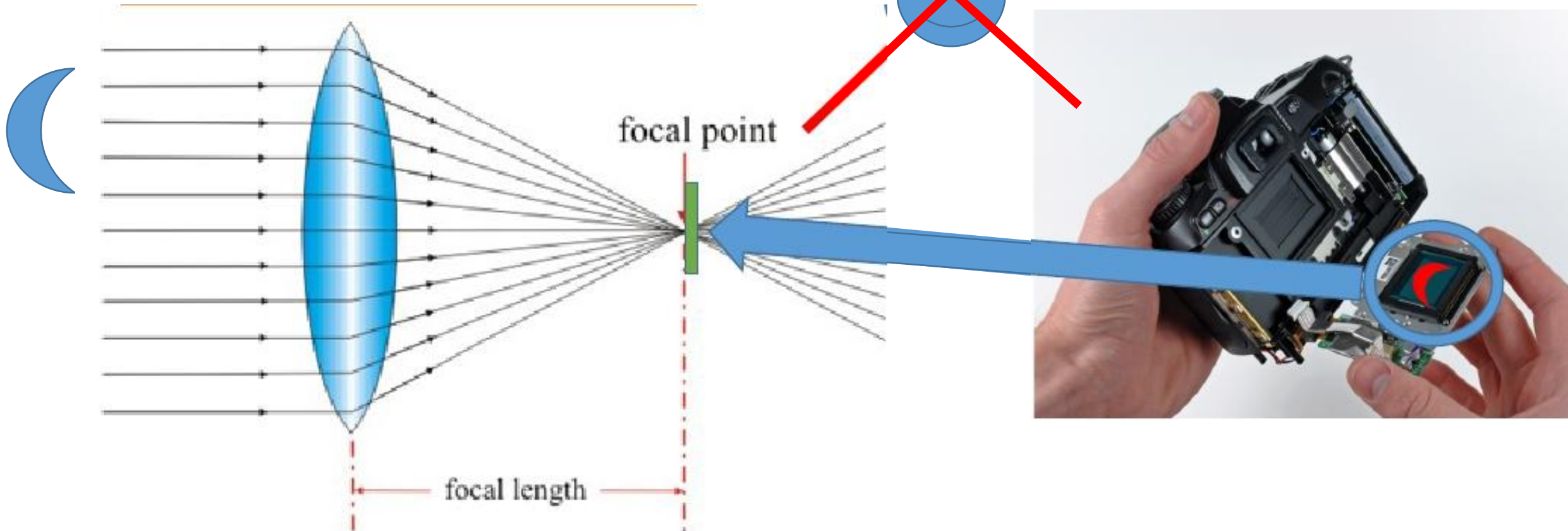

Most of the professional telescopes (or binoculars or photocameras) are “focal”: they form a direct image at a plane, where one places a detector (CCD, CMOS).

This is the simplest possible telescope: one lens focuses into the focal plane.

Galileo's telescope

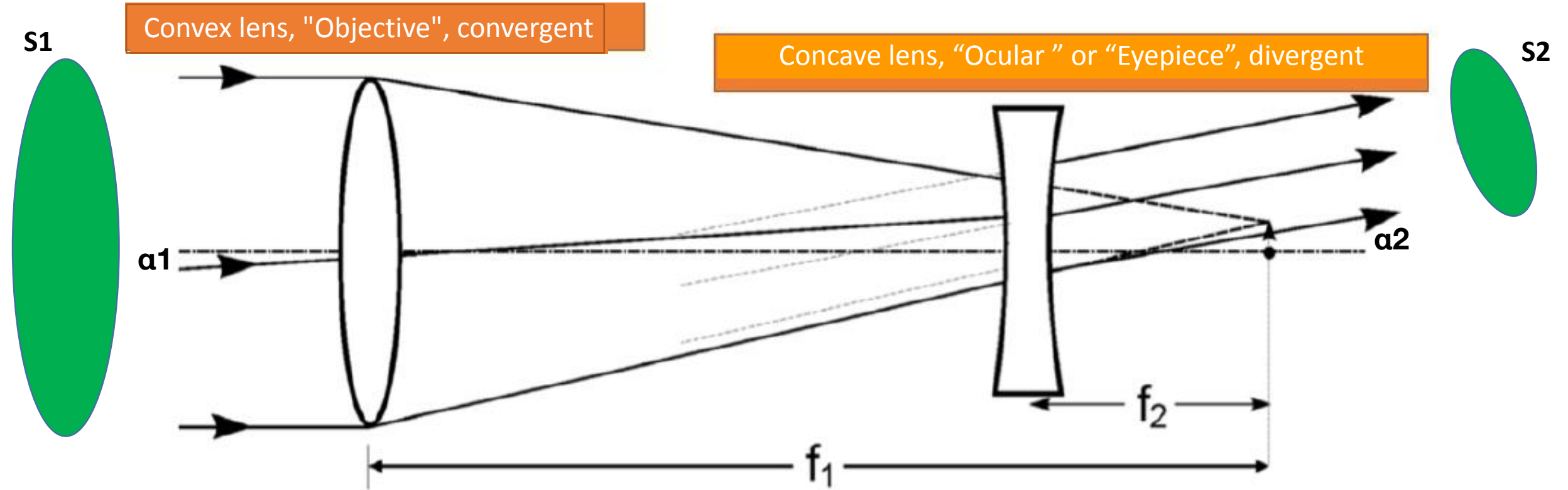

Light concentrates: $S_1 > S_2$, so the eye can see dimmer objects.

At the same time the angle subtended by the input object is smaller than the angle subtended by the image: "angular magnification" ($\alpha_2 > \alpha_1$)

Newton's telescope (1668)

Convex mirror, "Objective", convergent

Plane mirror: just meant to bring the light out of the telescope, so that your head doesn't block the view

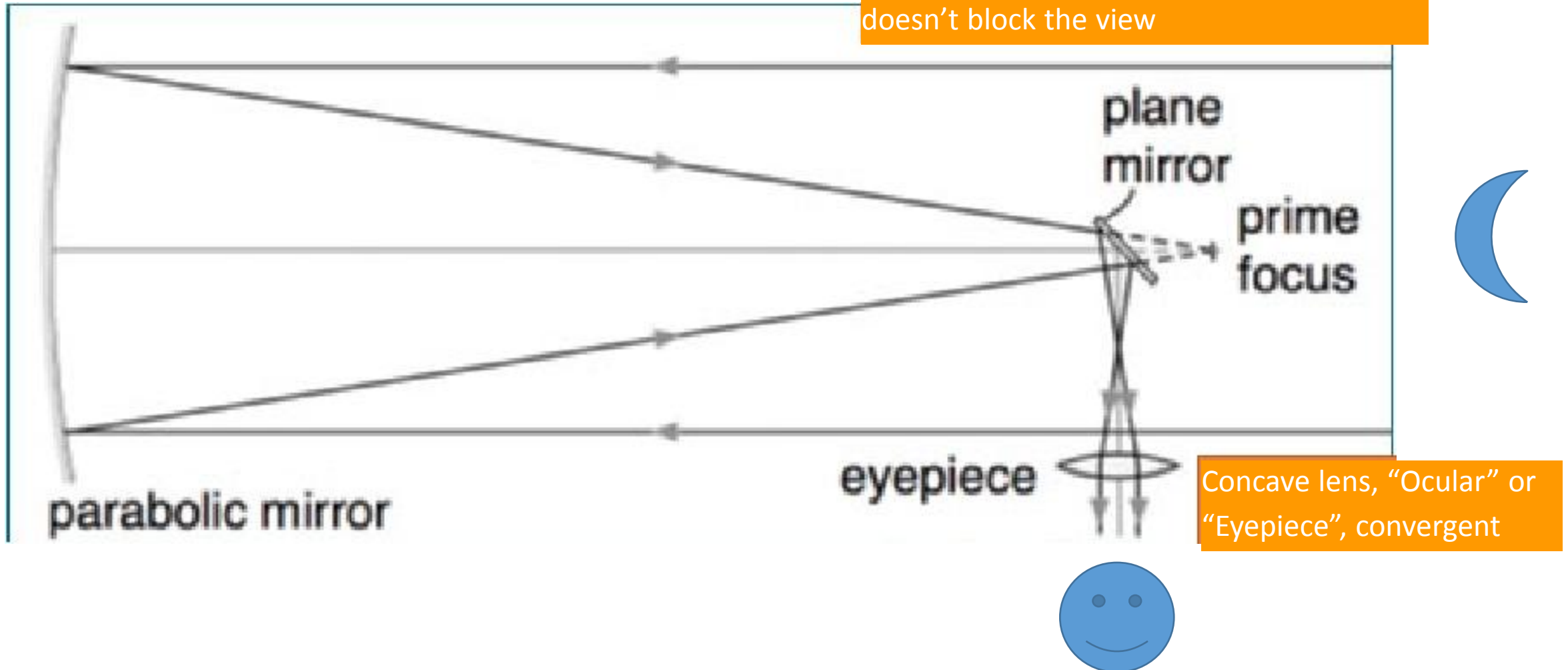

Concave lens, "Ocular" or "Eyepiece", convergent

Newton's telescope (1668)

Convex mirror, "Objective", convergent

Plane mirror: just meant to bring the light out of the telescope, so that your head doesn't block the view

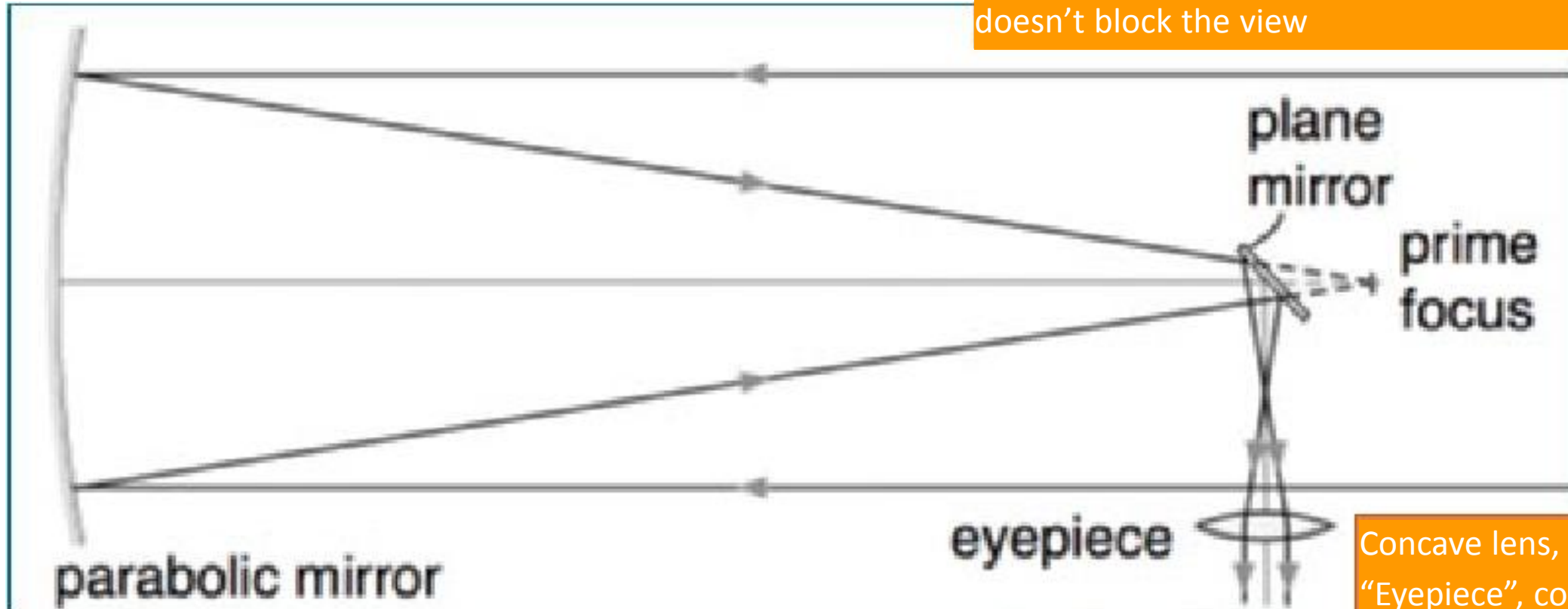

Concave lens, "Ocular" or "Eyepiece", convergent

Newton replaced the largest lens with a mirror. First "reflector".

Unfortunately reflectivity of mirrors at the time was very poor so reflectors were not used for a long time.

Again, this is an "afocal" system meant for your eye. If you used a CCD, you could place it at the "prime focus".

General astronomical requirements

1. Angular resolution: what is the smallest object we can resolve?
2. Light collecting power: what is the weakest object we can detect?
3. Field of view: what is the largest object we can image?

1. Angular resolution

- Angular resolution: ability to resolve two nearby objects. And of course relates to ability to image complex objects.
- Influenced by three factors:
 - Aberration of the optics.
 - Diffraction of the telescope aperture.
 - Atmospheric turbulence.

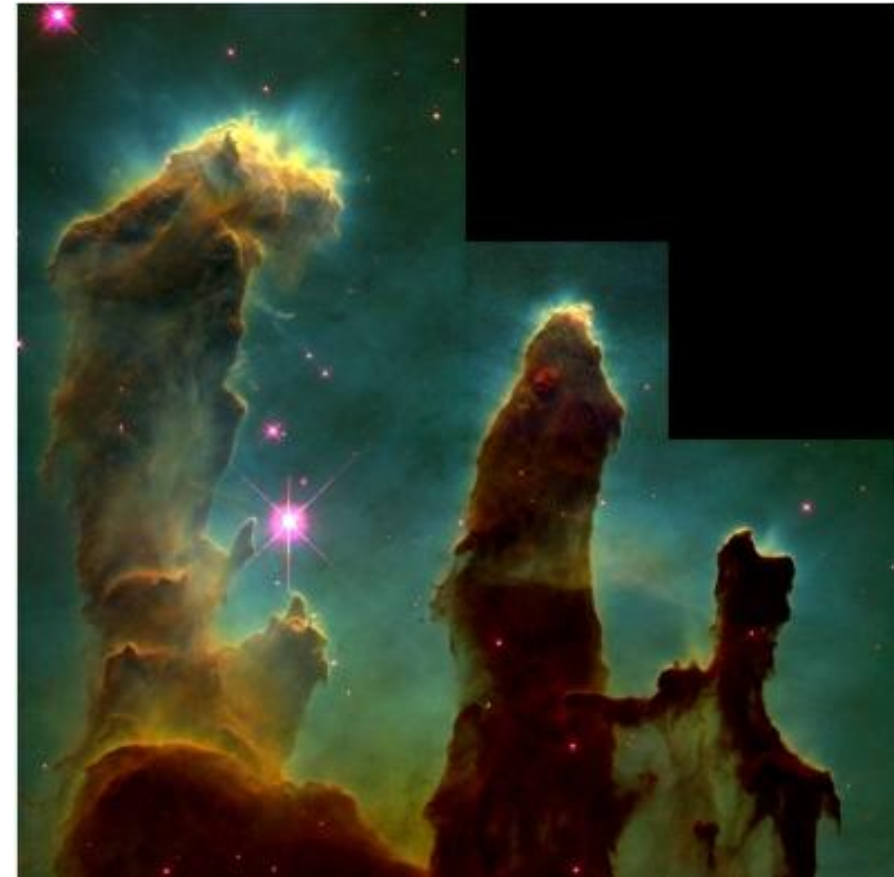
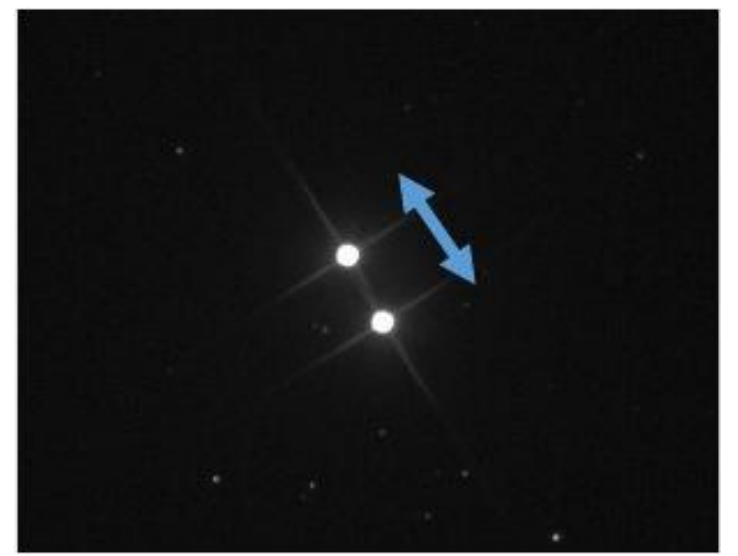

Successive approximations to an optical system

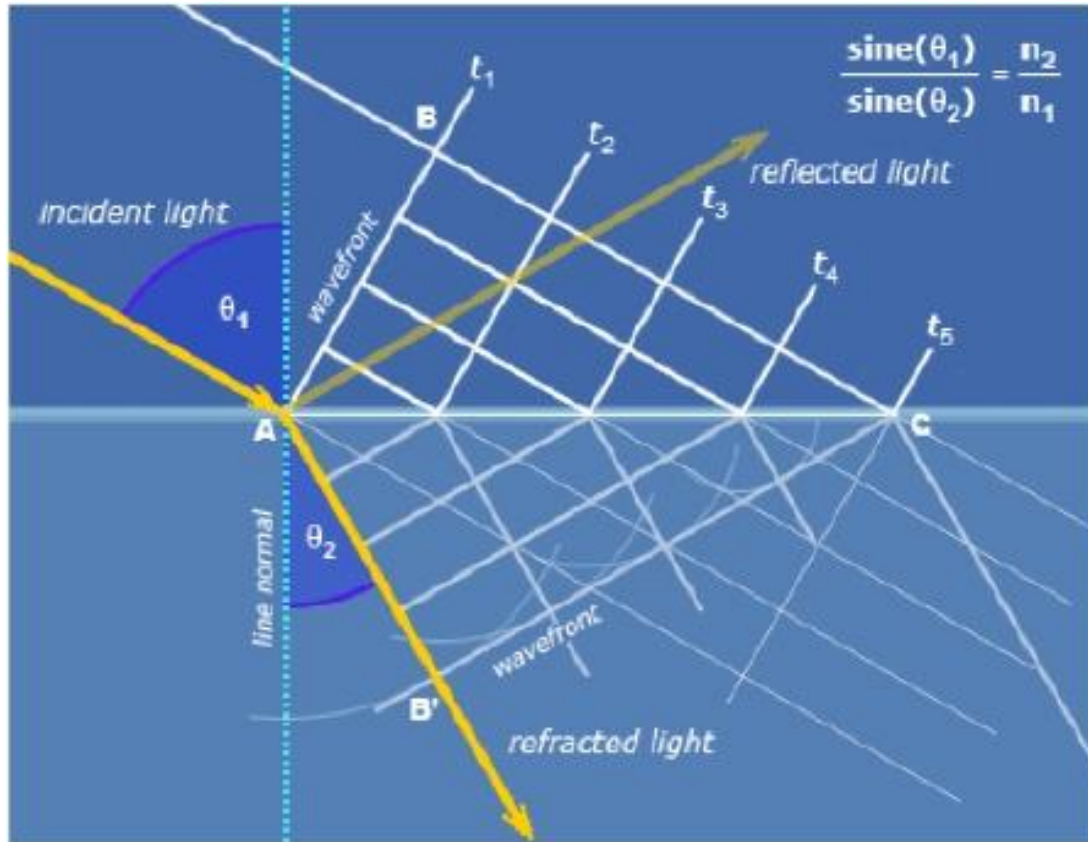

Snell's law: $n_1 \sin \theta_1 = n_2 \sin \theta_2$

One can make a Taylor expansion:

$$\sin \theta = \theta + \theta^3/3! + \dots$$

- **First-order or paraxial optics:** We assume $\sin \theta = \theta$. Valid only near the optical axis. Light from a single point in the object space goes to a single point in the image space.
- **Classical optics:** We consider the 1st and 3rd terms in the expansion. The image of a single point is a spot. Its shape is affected by so-called “optical aberrations”, but these aberrations are simplified.
- **Geometrical optics:** All terms are included and aberrations are fully considered, but we assume the light is a particle and not a wave.
- **Physical optics:** We add wave effects: diffraction and interference.
- **Quantum optics:** quantized photons are considered. Hardly considered in astronomy yet!

Aberrations: spherical

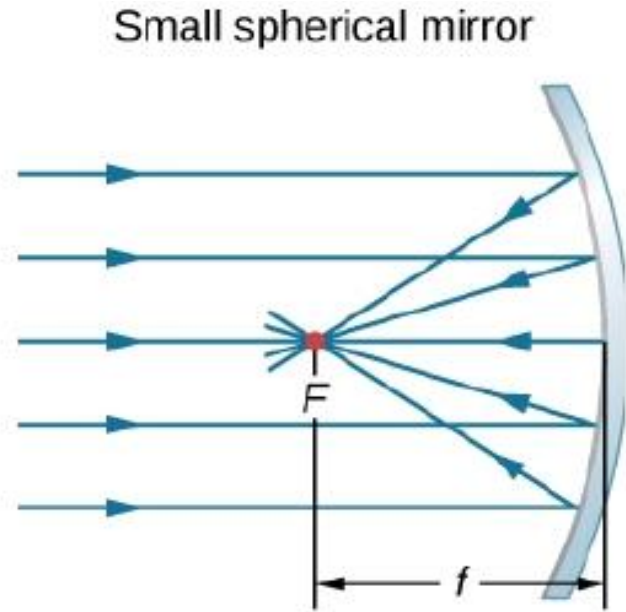

“Paraxial optics”

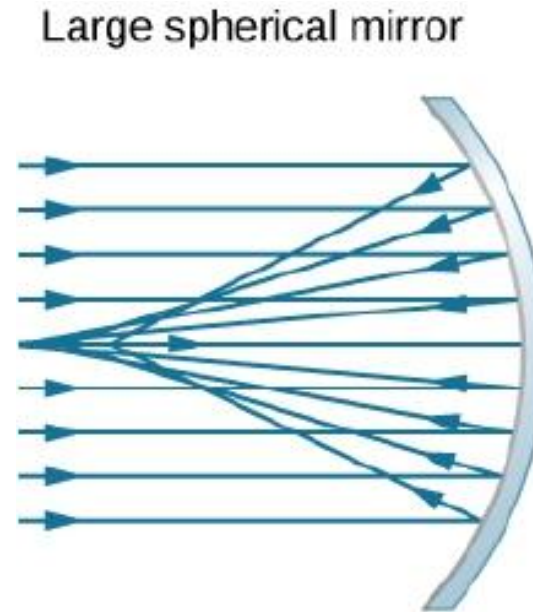

“Classical optics”

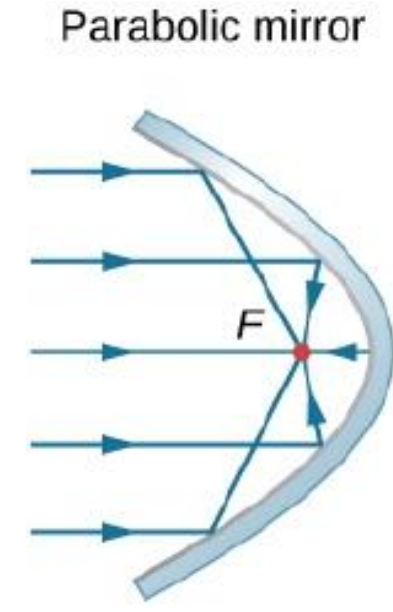

- In paraxial optics, all parallel rays go to the same point (focal point).
- In reality, rays cross at different points depending on radial distance.

This is called **spherical aberration**.

- As a consequence, the image of a fan of parallel rays is a finite spot.
- Can be avoided by using a parabolic lens instead of a spherical lens.

Solutions for large reflective surfaces

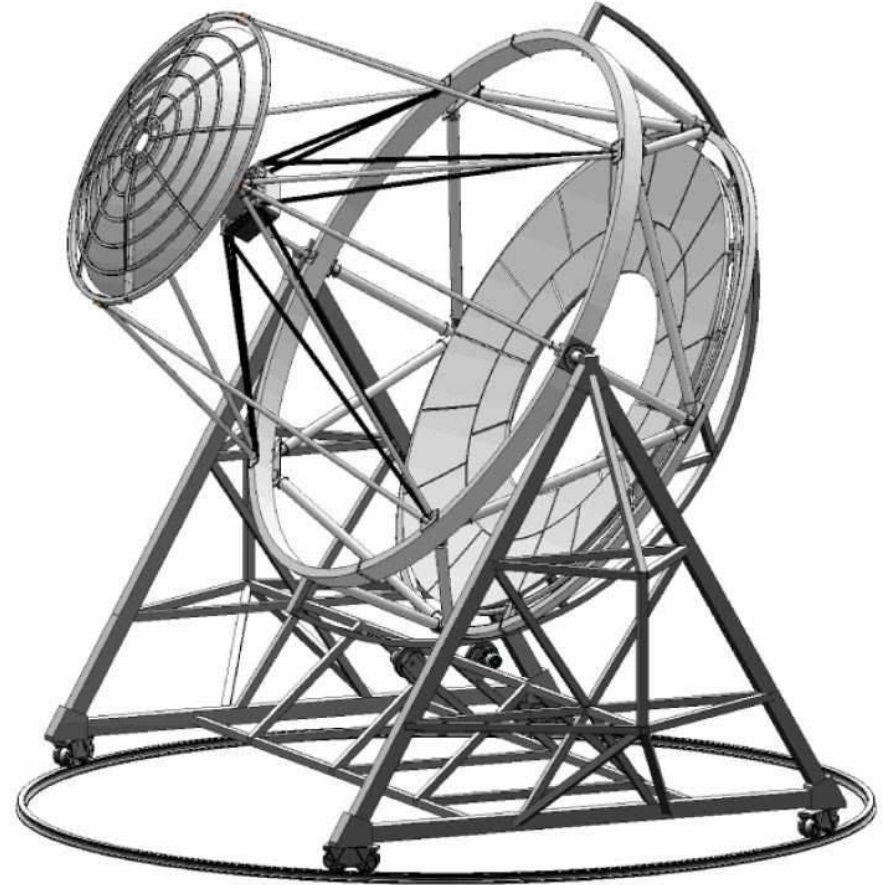
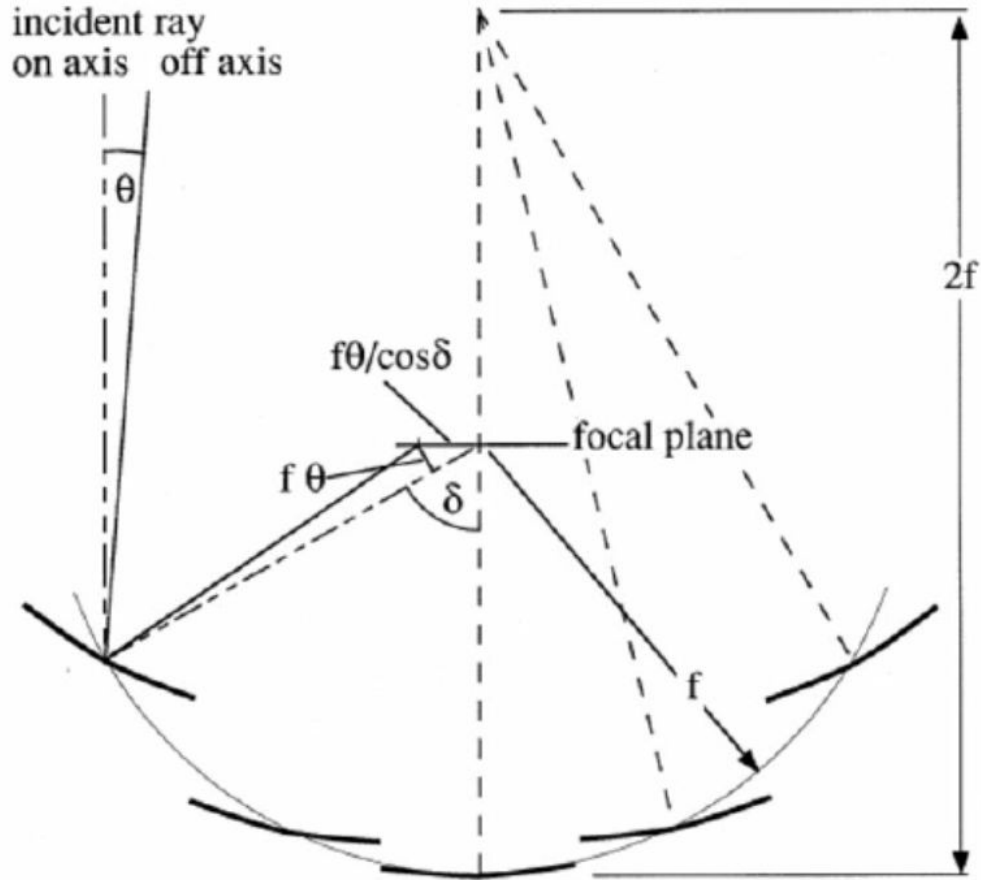

- Davies-Cotton reflector: Approximated parabolic configuration formed by several coronas of spherical mirrors.
- Schwarzschild-Couder: Double mirror configuration that allows to reduce the Point Spread Function

Aberrations: coma

However other aberrations pop up for rays with an angle respect to the optical axis. One of them is “coma aberration”.

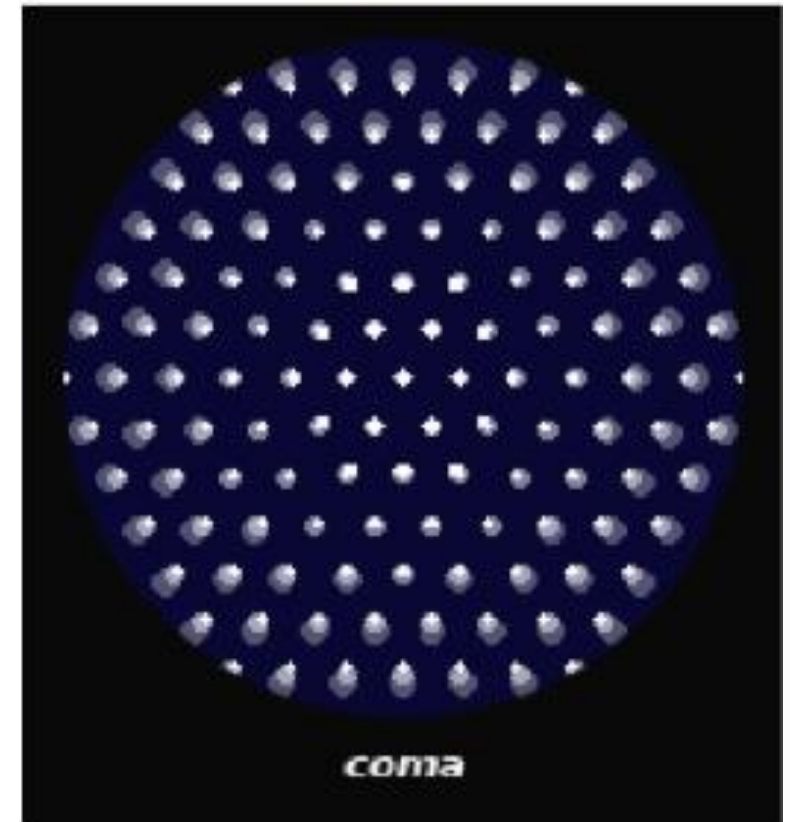
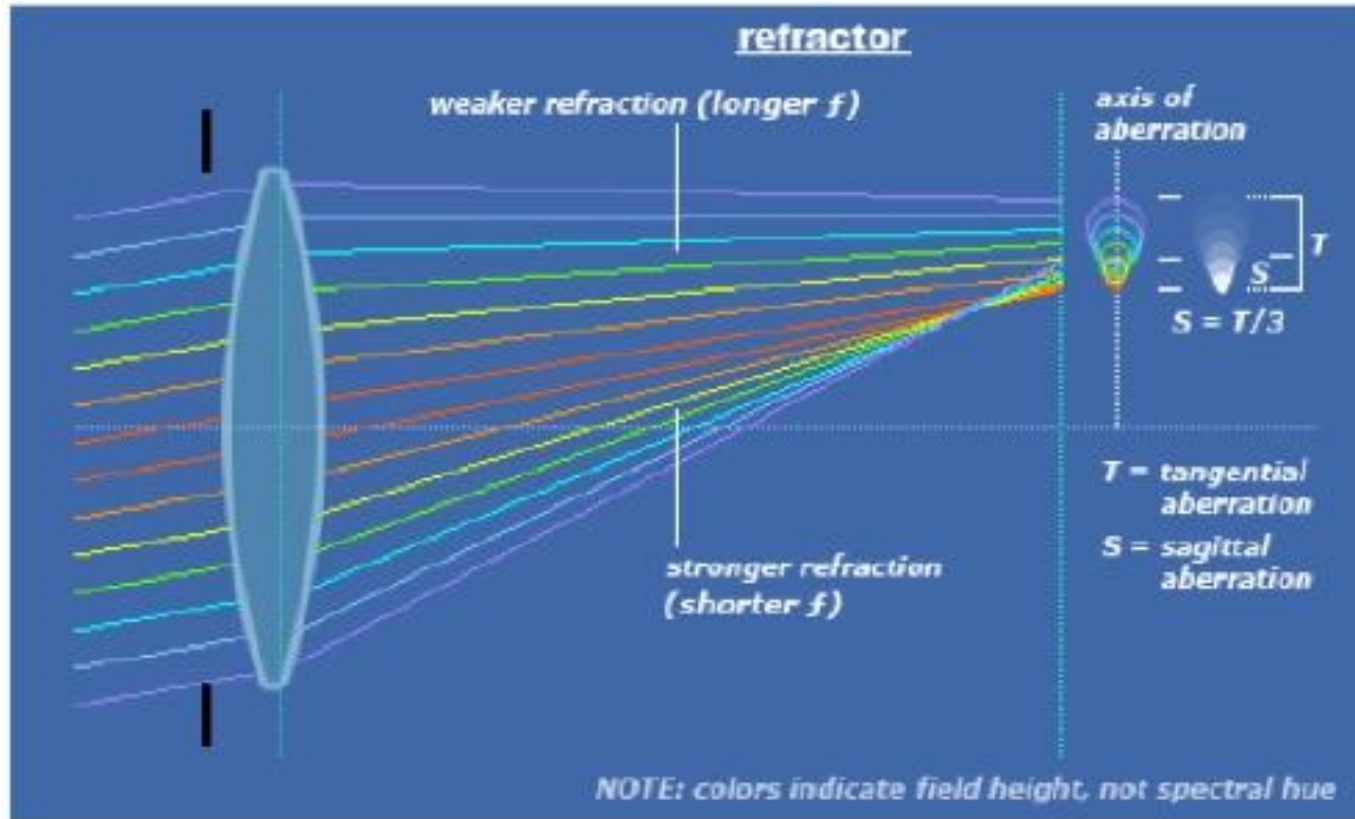

“Coma aberration” increases with angle to the axis.

Chromatic aberration

So far we assumed the refractive index (n) of the lens is constant, but it normally depends on the light's wavelength: $n(\lambda)$, meaning that the focal length of a lens actually depends on λ

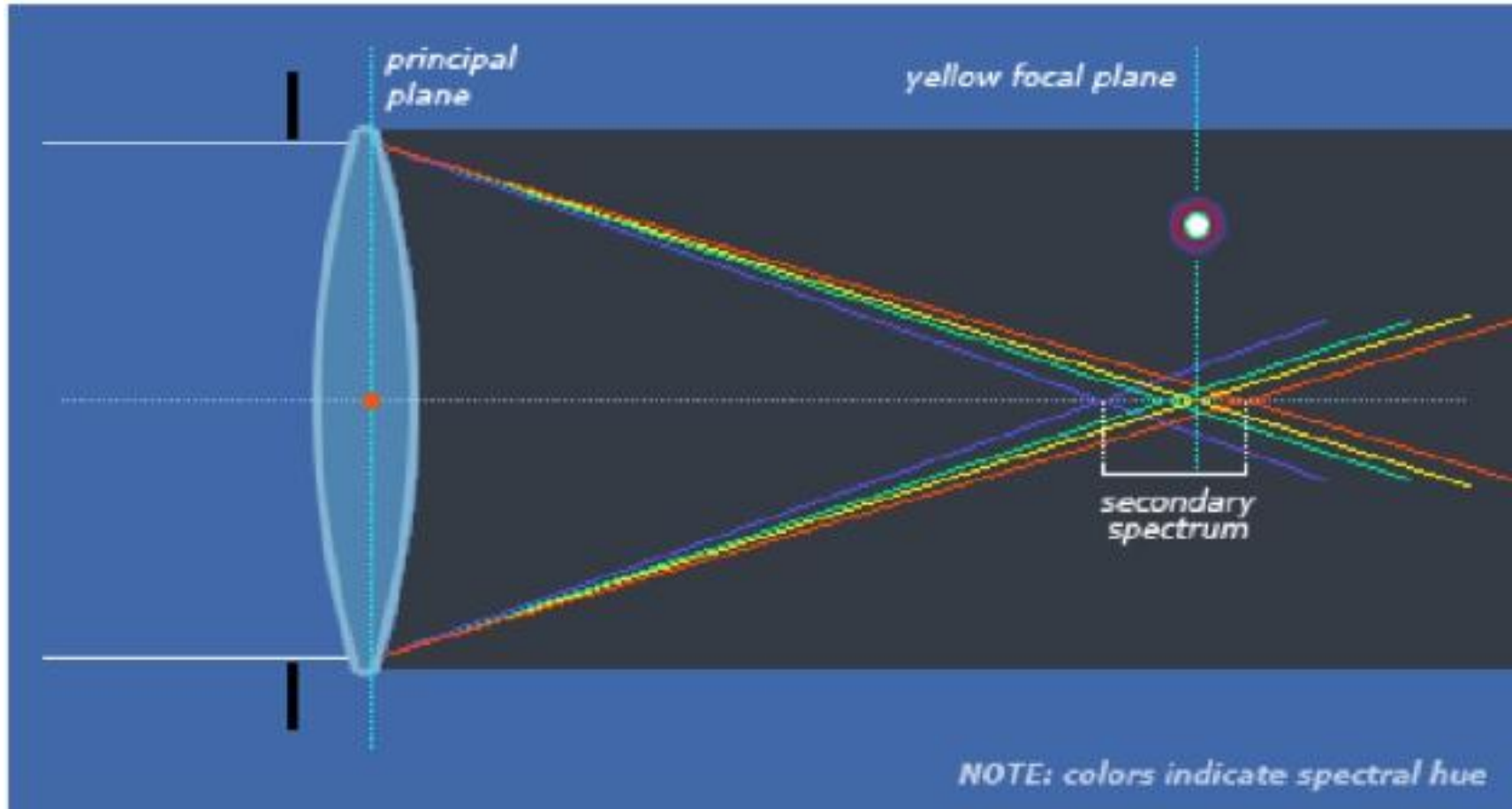

Aberrations and angular resolution

- Other aberrations:
 - Astigmatism
 - Field curvature
 - Distortion
- **Take-home message:** due to aberrations, a point source (i.e. a star) generates a blurred spot at the image space. This limits the angular resolution of the telescope.
- Telescope designers reduce the effect of aberrations by optimizing the optical parameters of the optical elements (lenses or mirrors)
- This can be achieved either using analytical formulas or computer simulations (“ray tracing”).

Diffraction

- Let's now take into account that light is also a wave (“physical optics”).

Wave impinges on a narrow slit

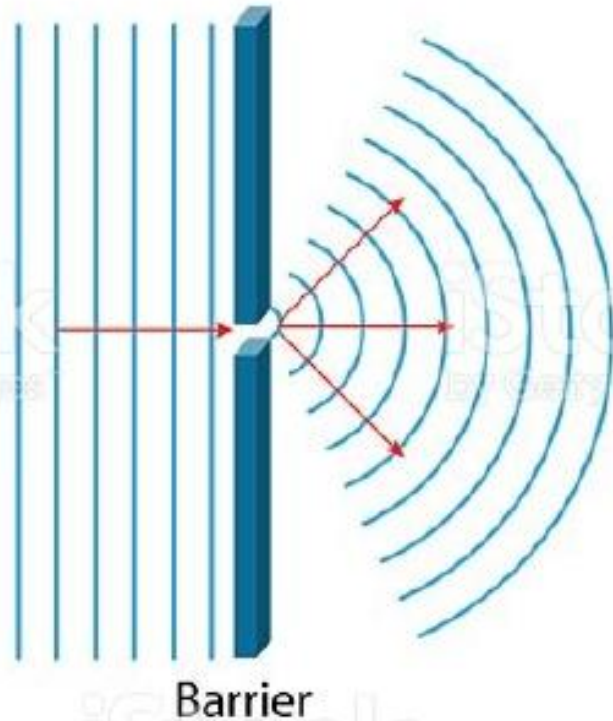

Wave interference

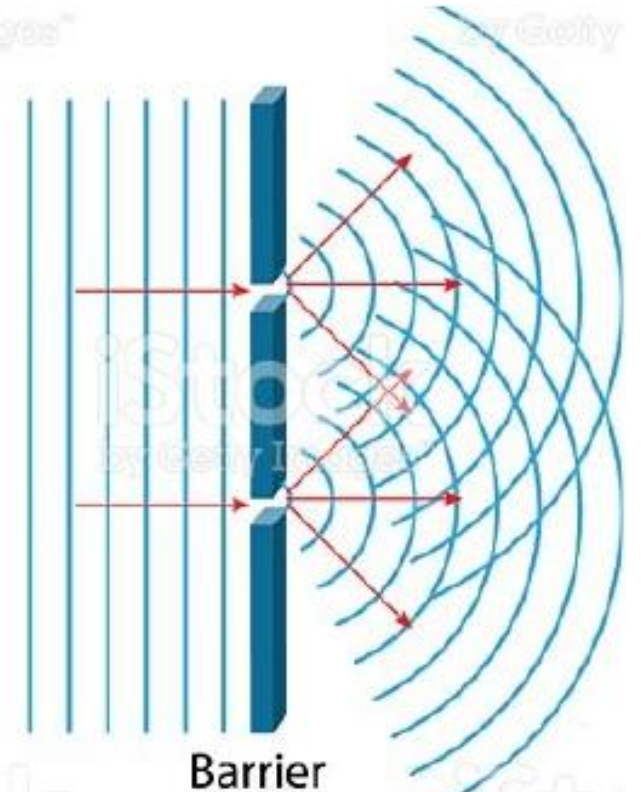

Diffraction

- Let's now take into account that light is also a wave (“physical optics”).

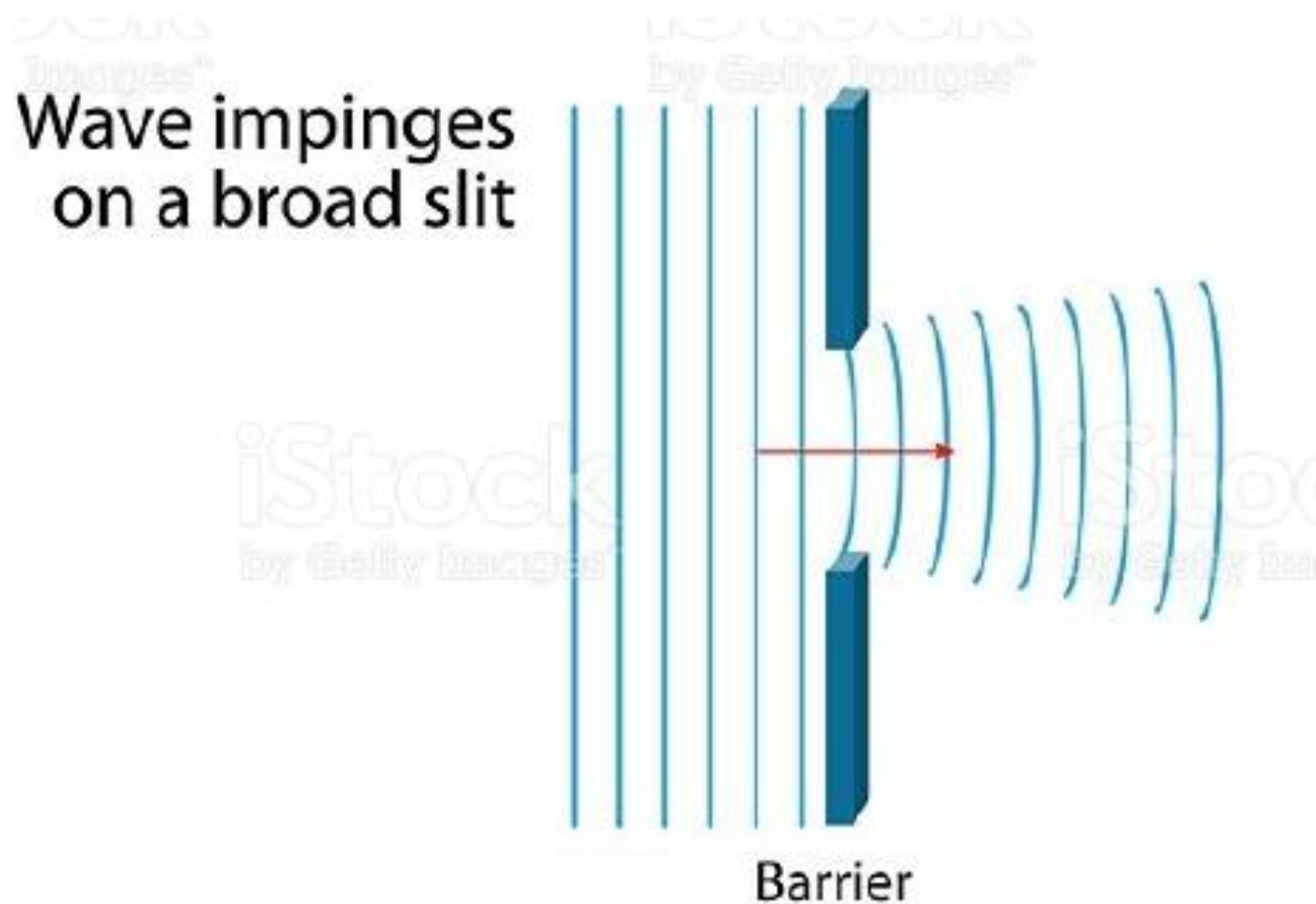

Diffraction: Airy disk

For a circular lens or mirror

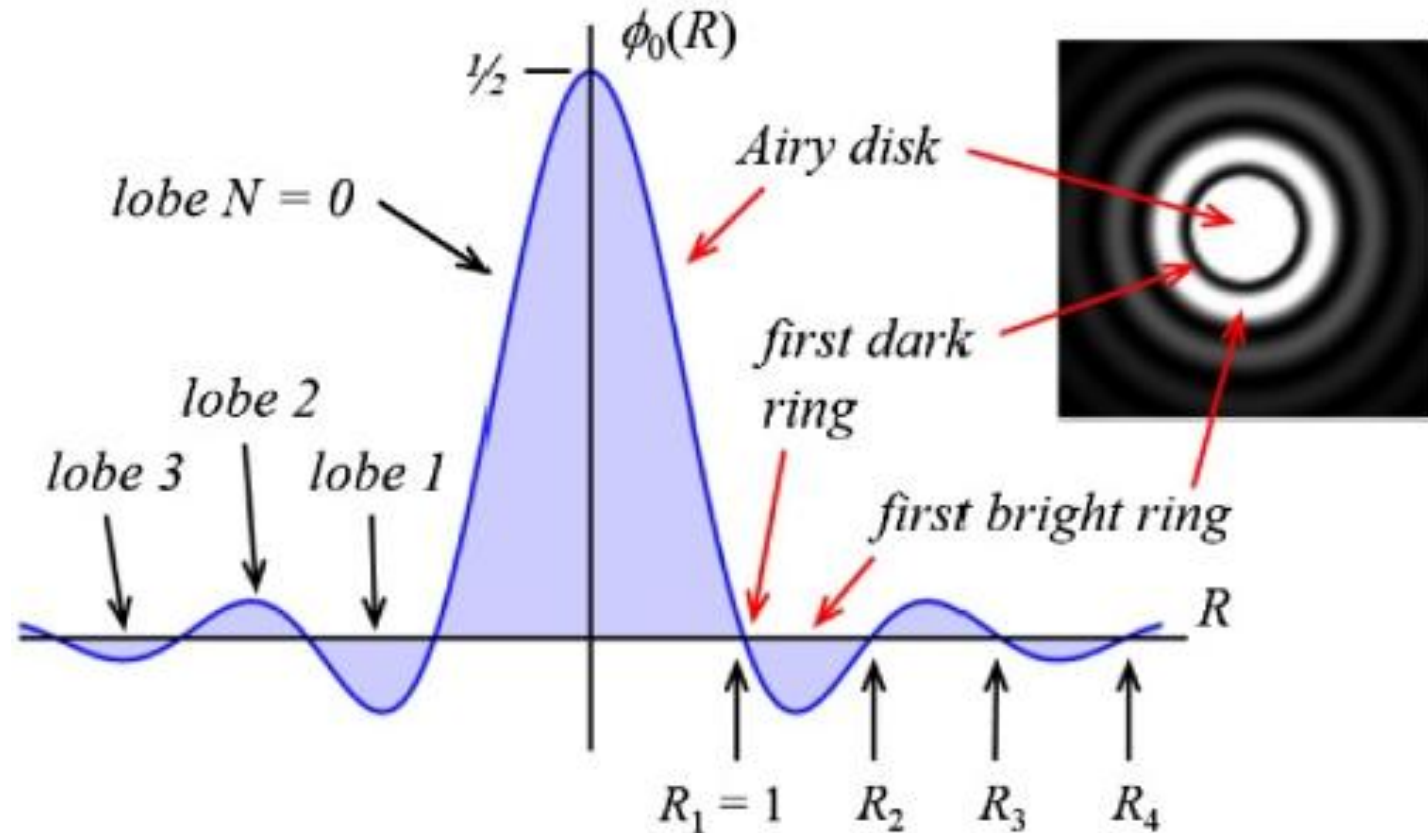
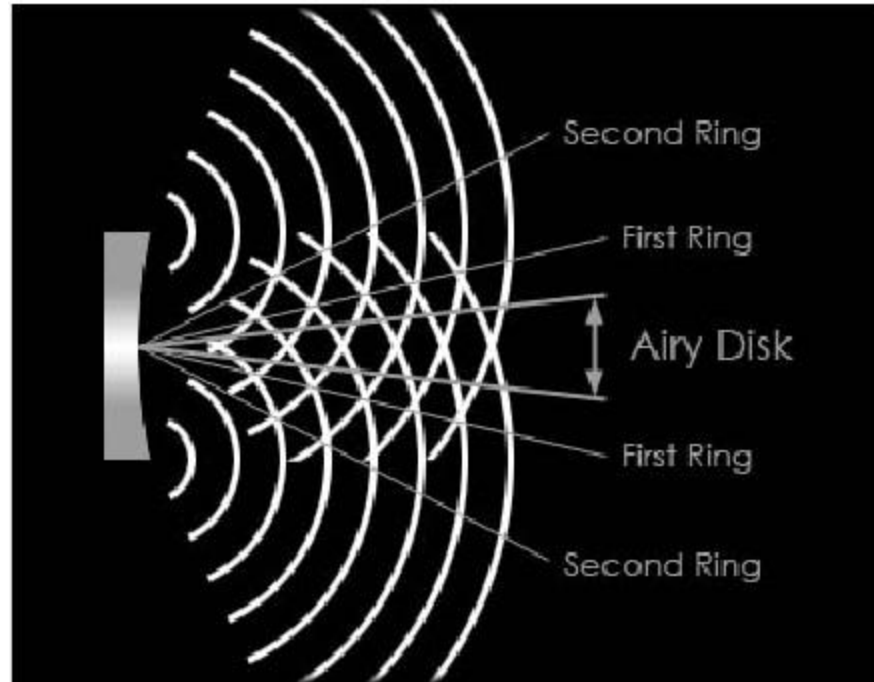

Diffraction: Airy disk

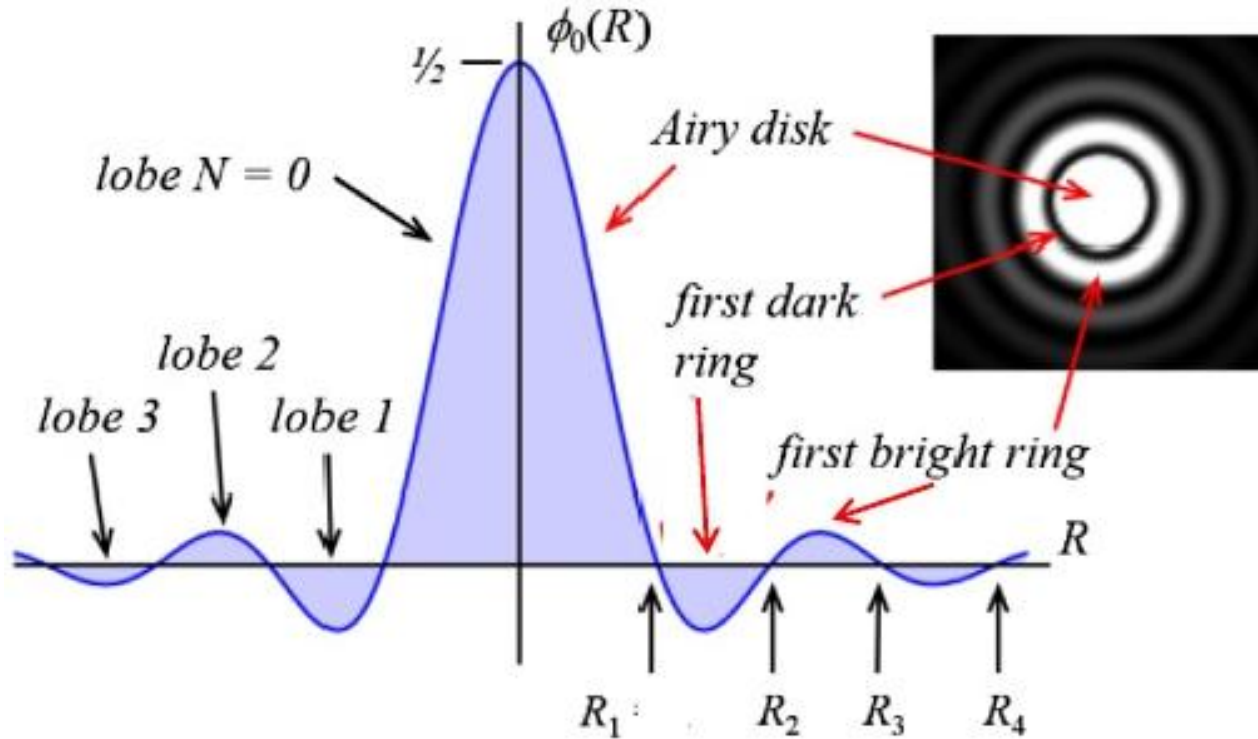

For a circular aperture (mirror, lens...):

$$\Phi(R) = \Phi(0) \cdot 2 \cdot J_1(\pi d R/\lambda) / (\pi d R/\lambda)$$

Where:

Φ = light amplitude

R = radial distance

d = mirror / lens diameter

λ = light wavelength

J_1 = first-order Bessel function

The radius of the first dark ring in radians is $1.22 \cdot \lambda/d$

Definition of angular resolution

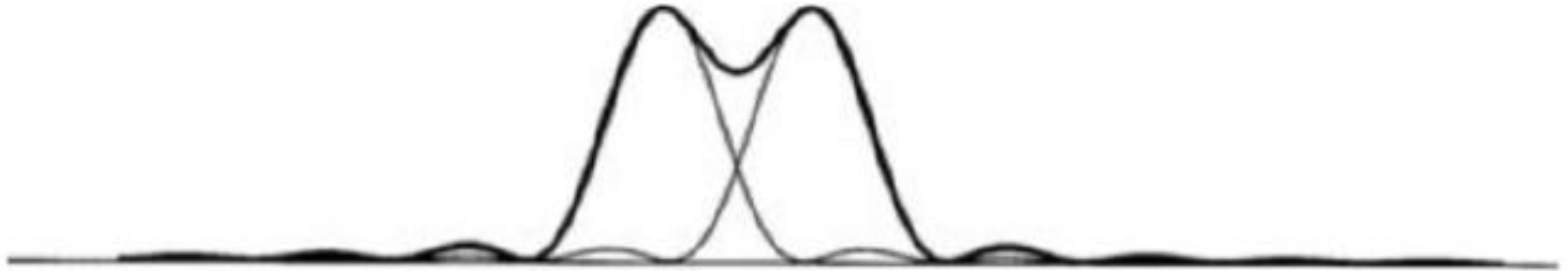

We move two stars of the same brightness until the peak of the second star is on top of the first dark ring of the first star.

Rayleigh's criterion: The angular distance between the two stars is the angular resolution.

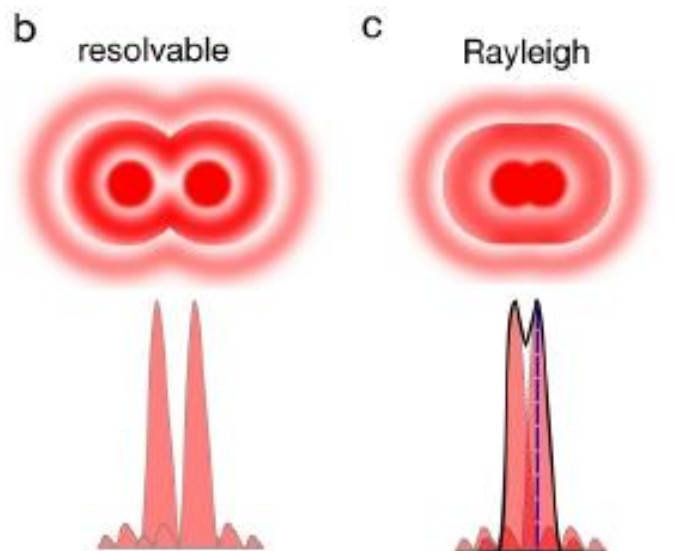

Of course we can only calculate the angular definition this way if the telescope's optical aberrations are small enough (i.e. telescope is "diffraction-limited")

Yet another challenge to angular resolution: The Atmosphere

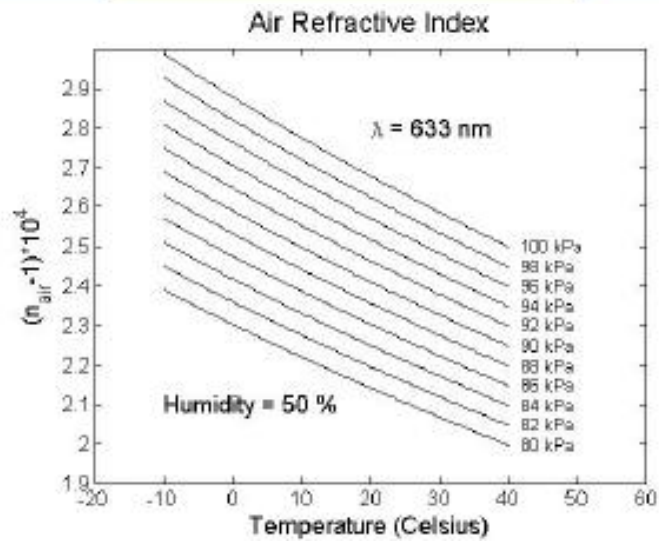
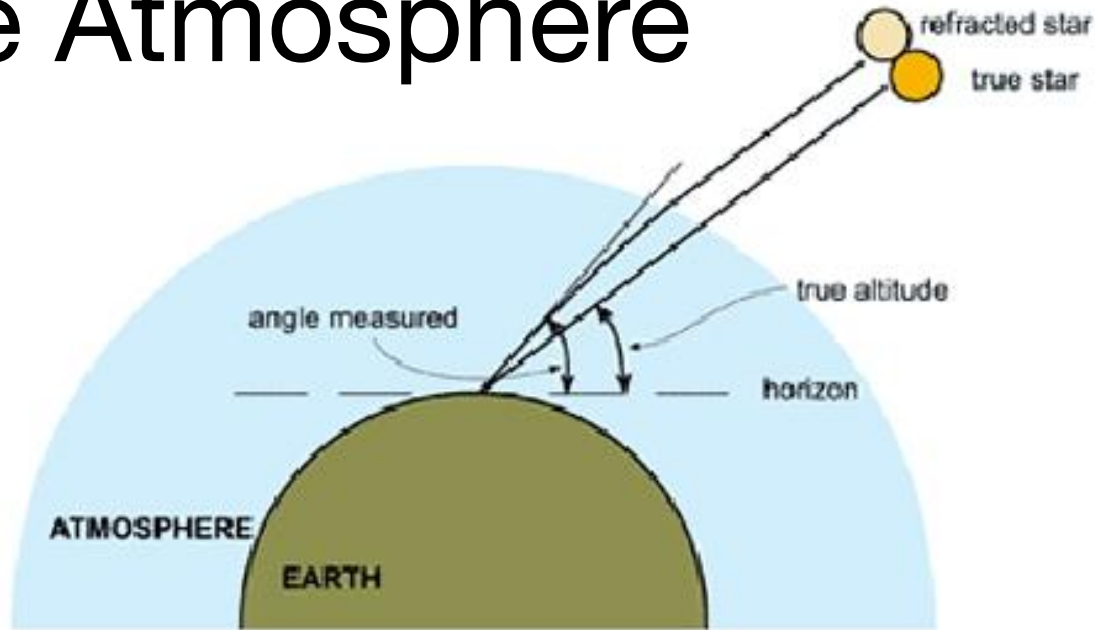

- Light from astronomical objects must cross our atmosphere.
- Air's refractive index depends on temperature (and pressure and humidity).
- In general terms, temperature in the atmosphere depends on altitude.
- As light goes through layers at different temperatures, it slowly refracts.
- As a result stars change apparent position.

Yet another challenge to angular resolution:

The Atmosphere

Real problem is:

The atmosphere is not simple. Wind generates turbulence at different scales and generates rather random structure of n .

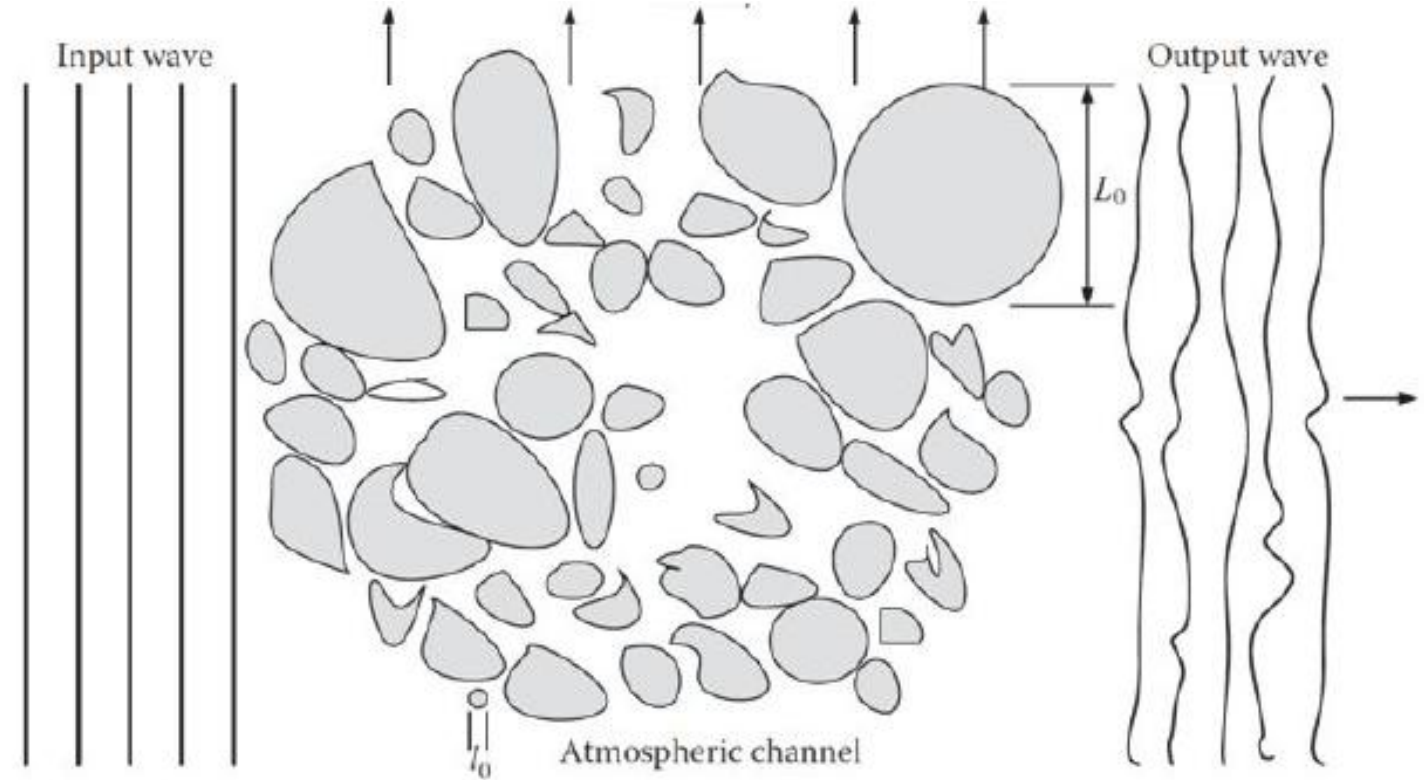

This has two effects:

1. Light spot gets wider, i.e. angular resolution gets worse.
2. Spot changes brightness with time (scintillation)

Effect of atmospheric turbulence

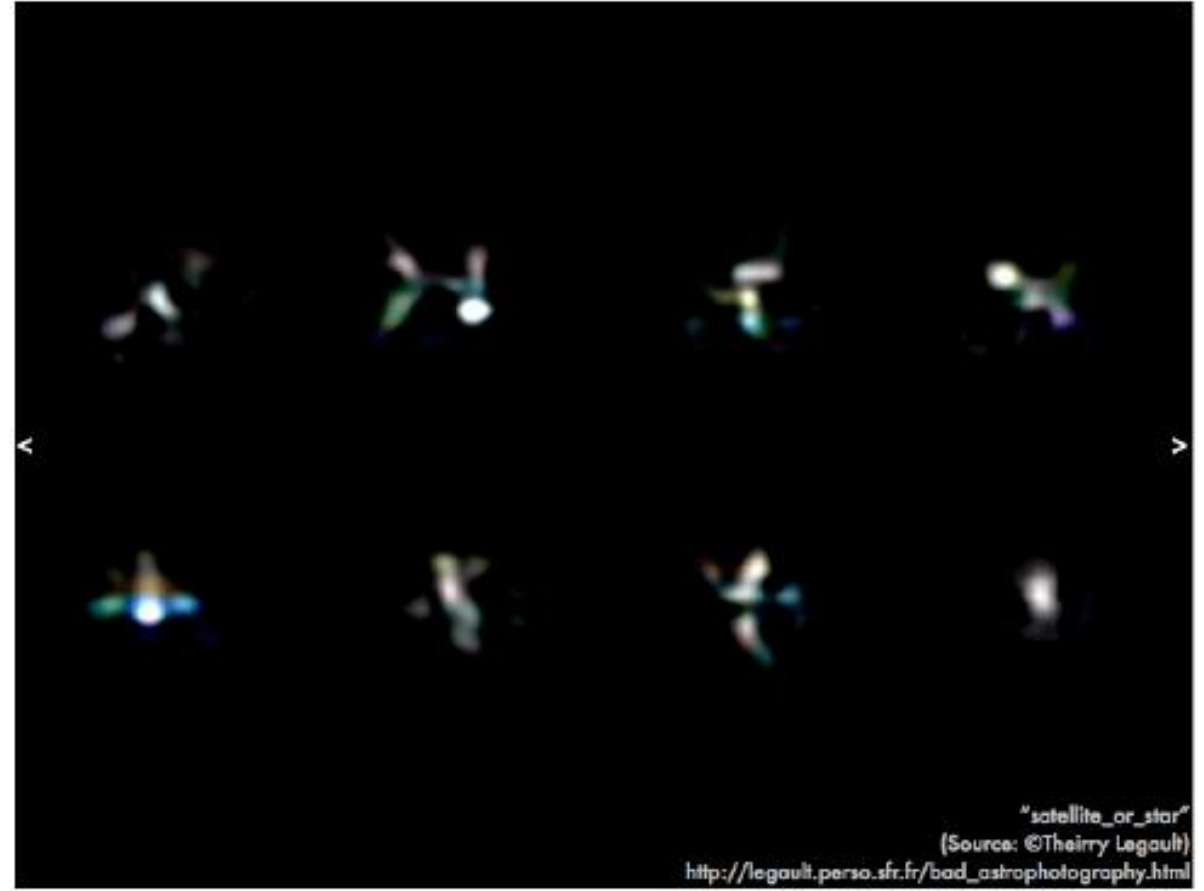

We will see how we can correct for this later on...

2. Light Collecting Power / Sensitivity

- The ability of a telescope to detect faint objects.
- The signal collected by a telescope can be expressed as:

$$N(t) = Q \cdot A \cdot t \cdot \Delta\lambda \cdot n_p$$

Where:

Q = combined photon detection efficiency of telescope and detector

A = aperture area of telescope

t = integration time

$\Delta\lambda$ = wavelength detection range (bandwidth)

n_p = photon flux per unit time, area and wavelength

The signal collected by a telescope can be expressed as:

$$N(t) = Q \cdot A \cdot t \cdot \Delta\lambda \cdot n_p$$

As a consequence:

- t is usually limited (~2000 h / year and strong competition with other astronomers)
It is essential to increase A. In other words, astronomers want larger and larger telescopes (mind the difference with microscopes, where objects are illuminated).
- Q includes efficiency of detector and telescope.
 - Old detectors: eye (?) and photographic plates (<10%).
 - New detectors: CCDs, high detection efficiency (quantum efficiency) approaching 100%.
- For reflectors, reflection loss is key.
 - Copper alloys: 45% (oldest reflectors were very bad)
 - Silver coating: 95%, but SO₂ in the air degrades them quickly.
 - Aluminium coating: 90% (even for near ultraviolet). Can be oxidized in the air and needs recoating every 1-2 years.

3. Field of View

- Optical telescopes are imaging devices. The field of view (FOV) is the solid angle of the sky that is imaged (typically measured in angular diameter).
- FOV is relevant for large size objects or when one intends to cover many small size objects in one single image.
- Spot blur size limits the FOV: aberrations get worse when going off-axis. For instance, for a parabolic mirror (Newtonian) in prime focus, coma equals $3\Phi/(16 F^2)$, where Φ is the half field angle and F is the focal ratio ($F=f/D$, with f =focal length and D =aperture).

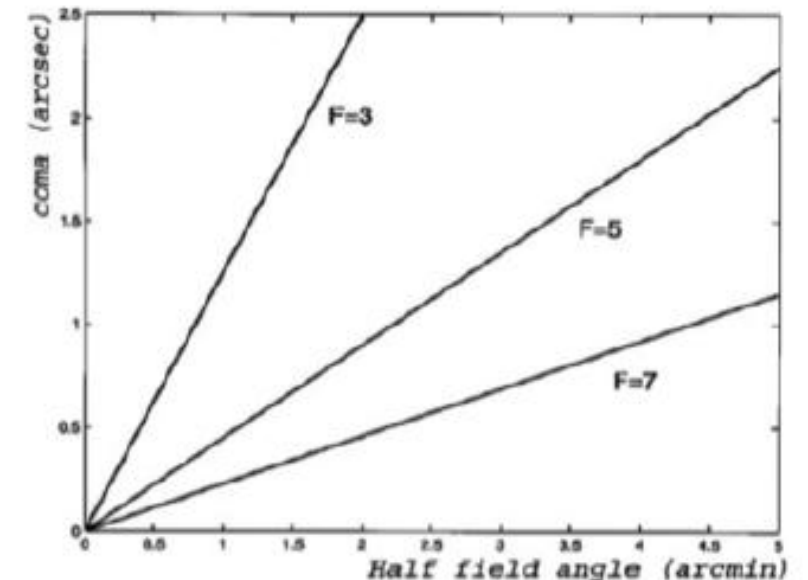
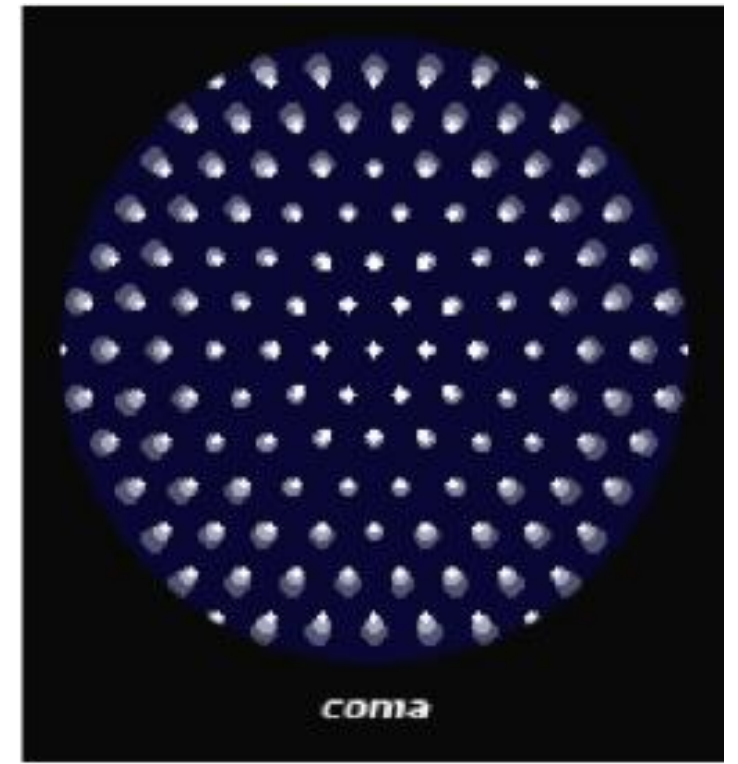

Large FOV: Schmidt telescope

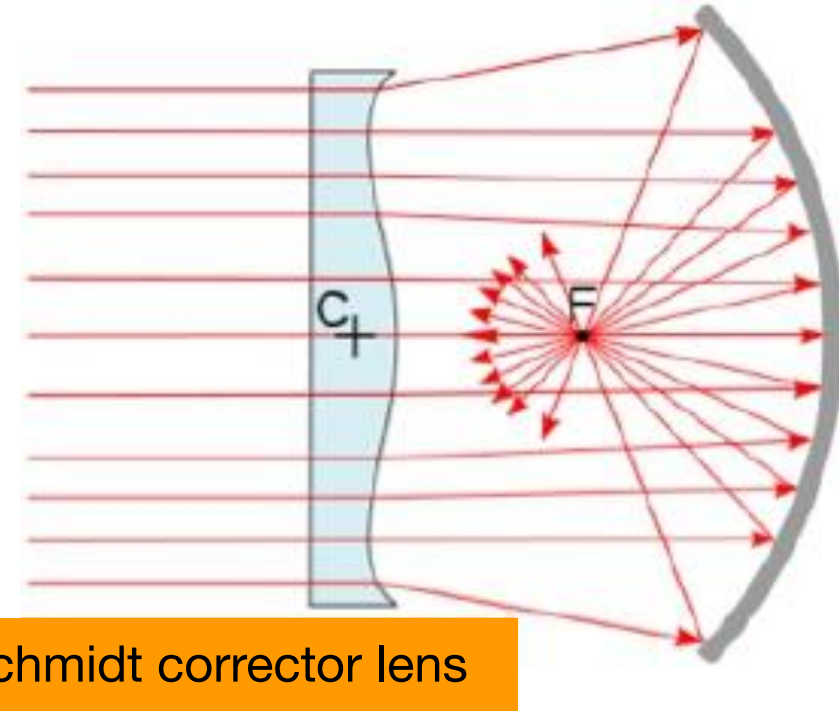
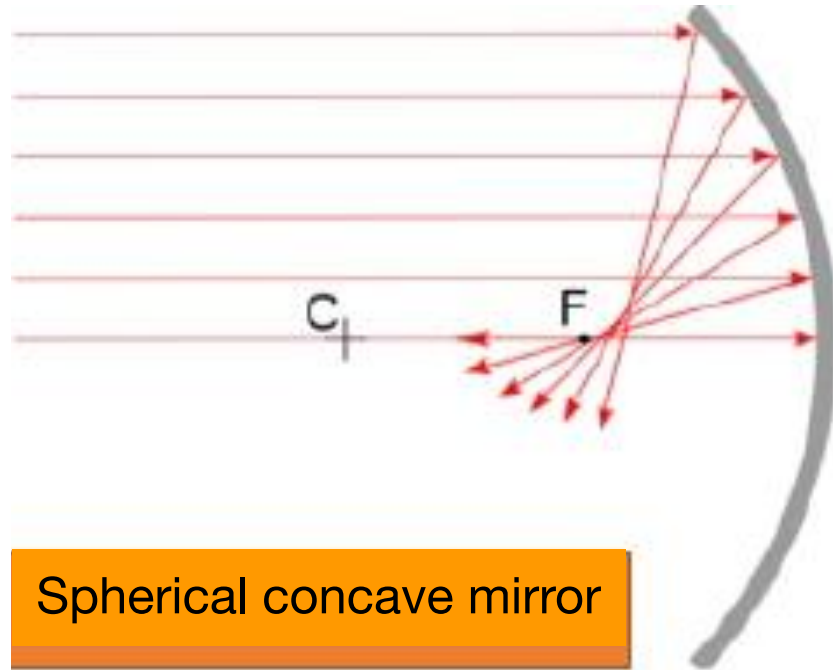

- Going beyond a few arcmin demands more complex optics, generally involving mirrors and lenses.
- In 1930 Bernhard Schmidt invented a classical design to achieve a FOV of ~ 5 deg, using a corrector lens of a complex shape.

Back to the history of telescopes

- Now that we know more about the astronomical requirements we can understand better how telescopes evolved since their invention.
- The first telescopes were refractors. Newton built a reflector in 1668, but the mirror reflectivity was too low and it suffered from spherical aberration.
- In order to fix this aberration, Gregory had actually proposed to use an elliptical concave mirrors in 1664 and Cassegrain a hyperboloid convex mirror in 1672, but such mirrors were too difficult to build.



Herschel's 1.2m mirror made of "speculum"
(copper and tin) in 1789

The era of refractors

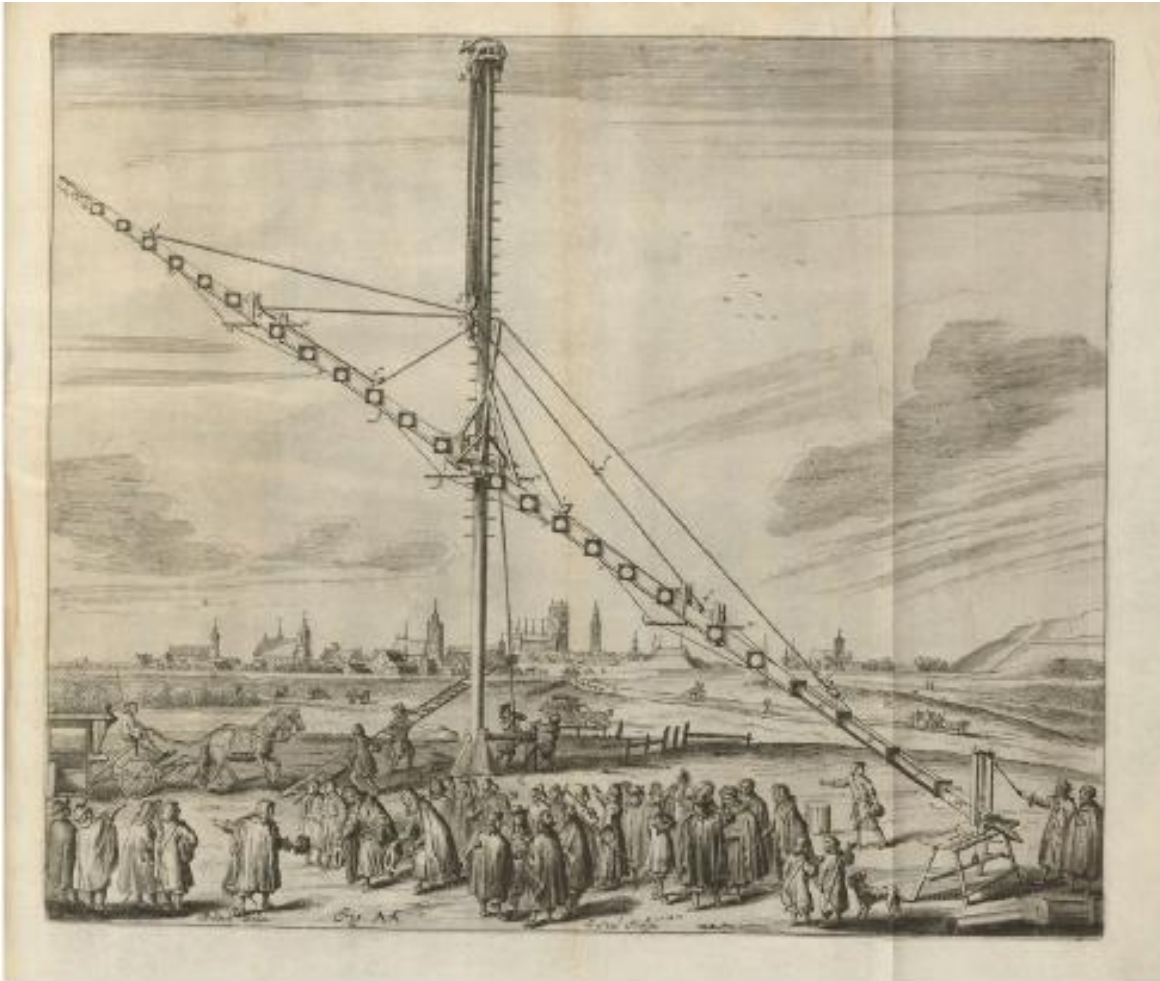

Hevelius 46m telescope in Gdansk

- Refractors suffered from chromatic aberration. In order to reduce them, and in order to increase magnification, Huygens proposed to use a longer focal length.
- Hevelius built a telescope of $f=46\text{m}$ length and $D=20\text{ cm}$ ($f/D=230$) in 1670.
- In 1758 Dollond invented “achromatic lenses”: he combined lenses of different n to compensate for chromatic aberration.
- In 1895 the largest refractor in the world was built at Yerkes, with $f=19\text{m}$ and $D=102\text{ cm}$ ($f/D=19$).
- The 2nd largest is a solar telescope (Swedish tower, 98cm) in La Palma (Spain). Solar = very different requirements!

Johannes Hevelius - *Prodromus Astronomiae*



Again from Brera Observatory !

Reflectors reloaded

- In 1856 the first optical telescope with a coated silver surface mirror was built.
- 1917: 2.5m reflector in Mount Wilson.
- 1934: new method of aluminium coating in vacuum is invented. Allows for 5m reflector in Mt. Palomar.
- In 1969 the Soviet Union built a 6m reflector. It used for the same time an alt-azimuth mount. This made even heavier telescopes possible.
- In 1979 the Multiple Mirror Telescope was built at the F. Whipple observatory: for the first time six mirrors are combined into one structure and it features a co-rotating building.

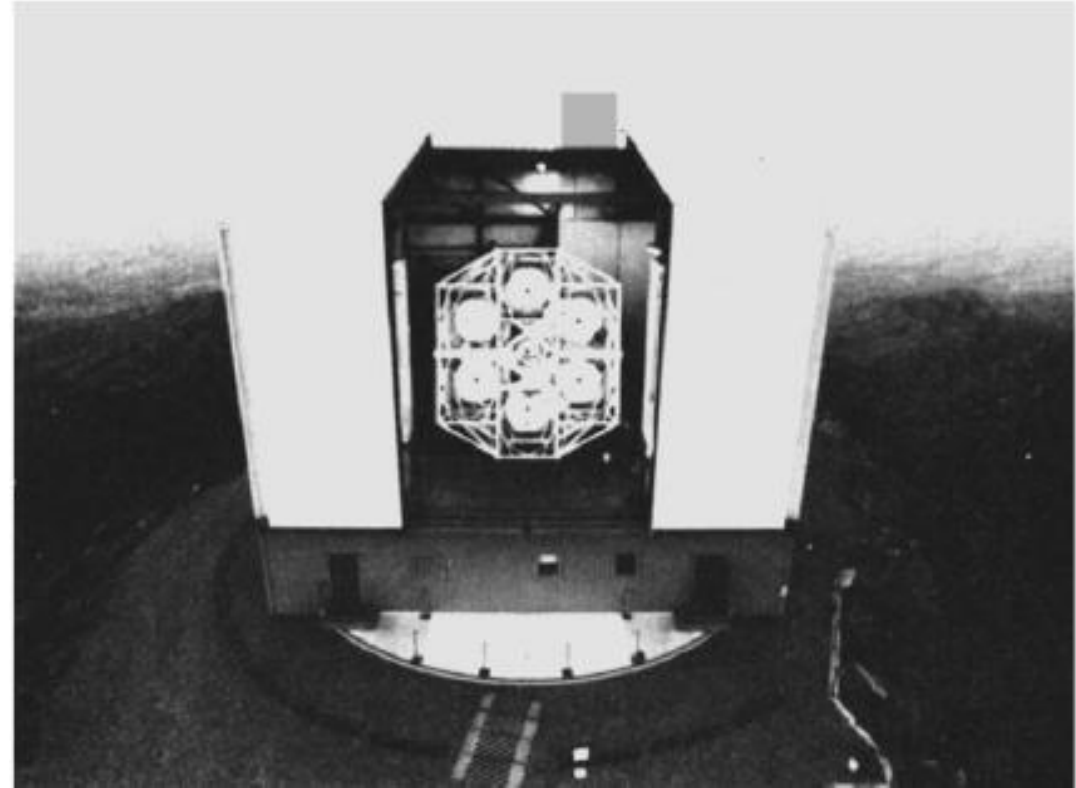

MMT at Mt. Hopkins (1979). The mirrors had been donated by the US military.

Adaptive optics

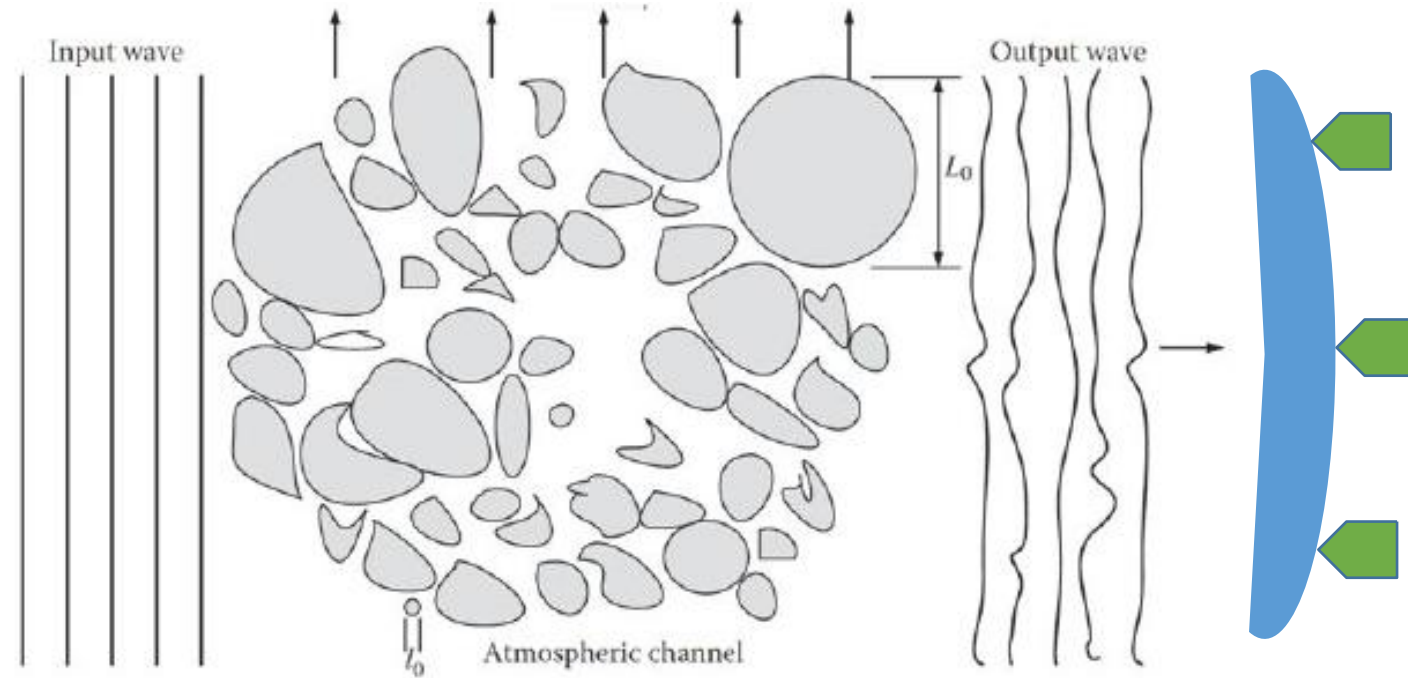

Deform mirror to compensate

- A possible solution is to compensate for deformations in the output wave by deforming the telescope mirrors.
- Actuators apply pressure on the mirror to correct its shape slightly at a very fast rate (several times a sec).
- The first telescope equipped with adaptive optics was the European NTT in Chile in 1989.
- One must use a bright star as a reference to deform the mirror. However it was hard to find bright stars in the FOV of the objects under study. The solution was to create fake “guide stars” using lasers (after 1990).

The last generations

- The 2.4m Hubble Space Telescope is in space since 1990. It was recently overtaken by the 6.5m James Webb space telescope.
- The largest optical reflector in the world is the 11m GTC in La Palma (Spain). It may be surpassed soon by three monsters:
 - 22m Giant Magellan Telescope under construction in Chile.
 - 30m Thirty Meter Telescope in Hawaii or La Palma.
 - 42m Extremely Large Telescope under construction in Chile.

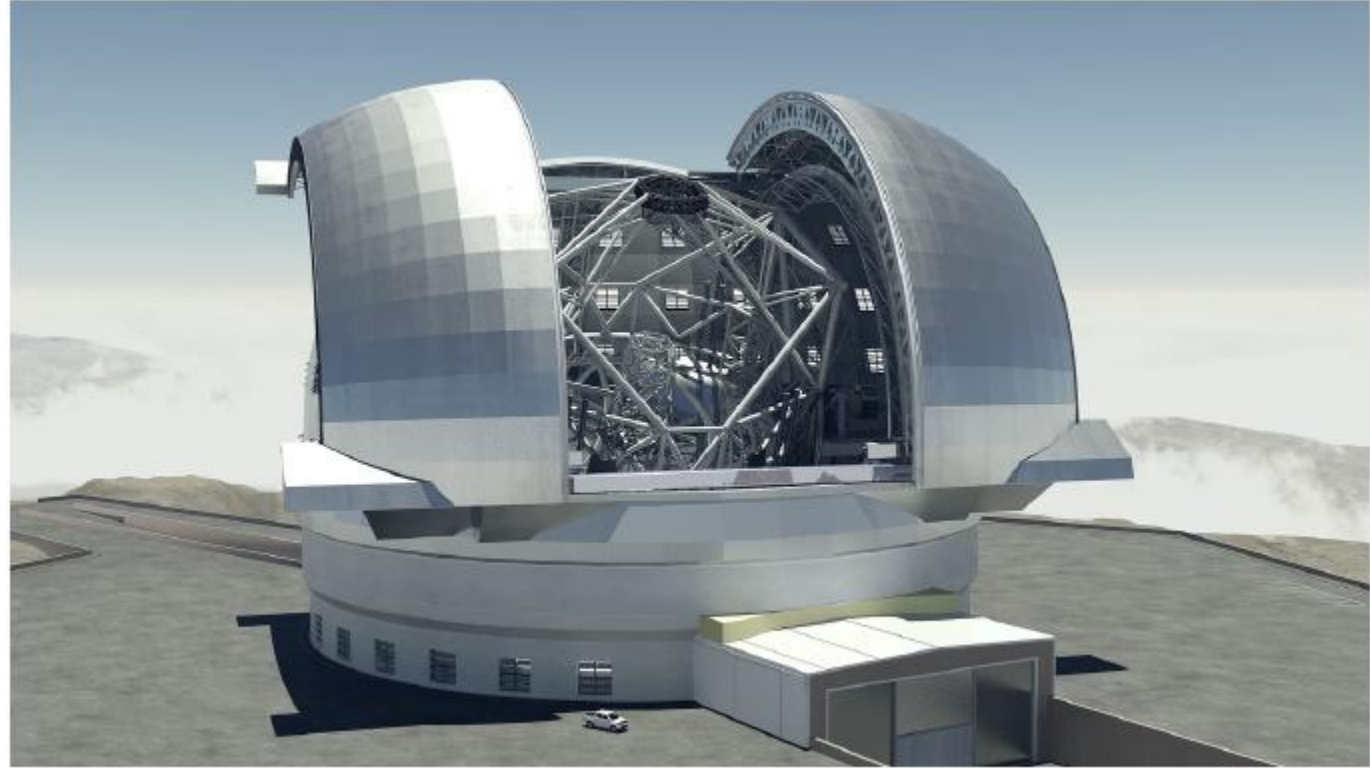

Just a glimpse into the optics of EELT

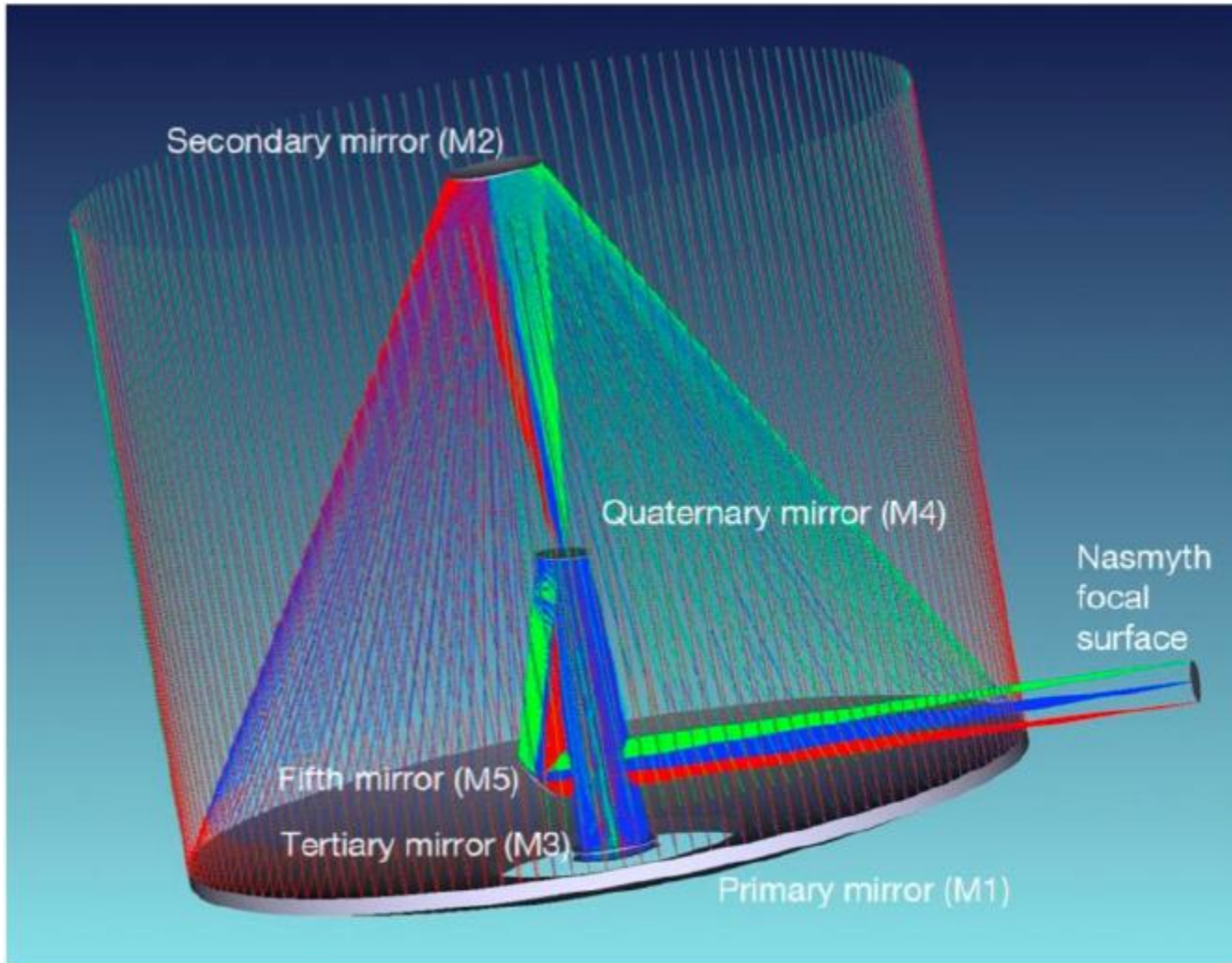

EELT proposal:

- The $f/0.88$ elliptical primary mirror (M1, conic -0.996) has a diameter of approximately 39 m and an 11 m central obstruction.
- The 4.1 m secondary mirror (M2) is convex and returns the beam, through a hole in the quaternary mirror (M4), to the 3.7 m mildly aspheric concave tertiary mirror (M3) located at the vertex of the primary.
- The beam is reflected to the 2.4 m quaternary flat adaptive mirror that is inclined at 7.7 deg to the beam direction.
- The fifth mirror (M5) in the train is flat, elliptical in contour (2.6 m \times 2.1 m), defines the altitude axis of the telescope, and steers the beam towards the Nasmyth focus.
- The output beam at $f/17.5$ is very nearly diffraction-limited over the entire 10 arcmin field of view.

4. Atmospheric windows, site selection

- The “visible spectrum” corresponds to photons with wavelengths in the range 400 to 700 nm. The electromagnetic spectrum extends well beyond.
- However most of the photons outside the visible range are absorbed in the Earth’s atmosphere, except for those in the so-called “atmospheric windows”.

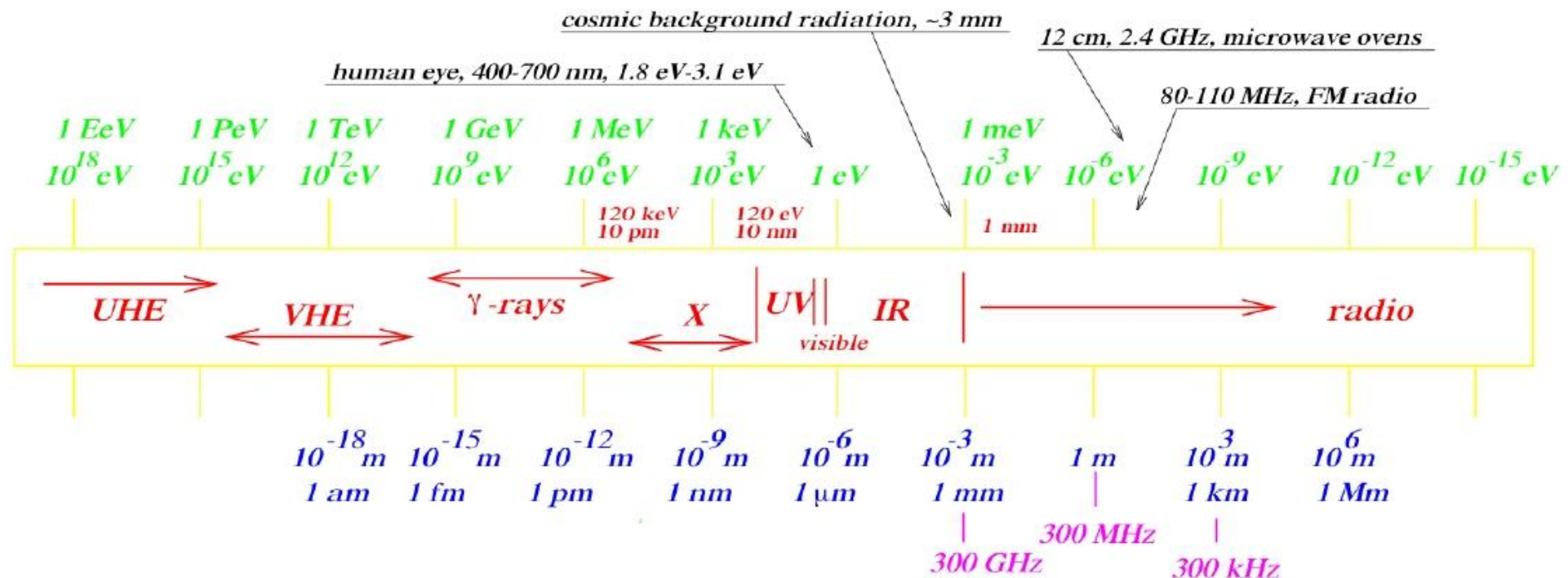

Atmospheric windows

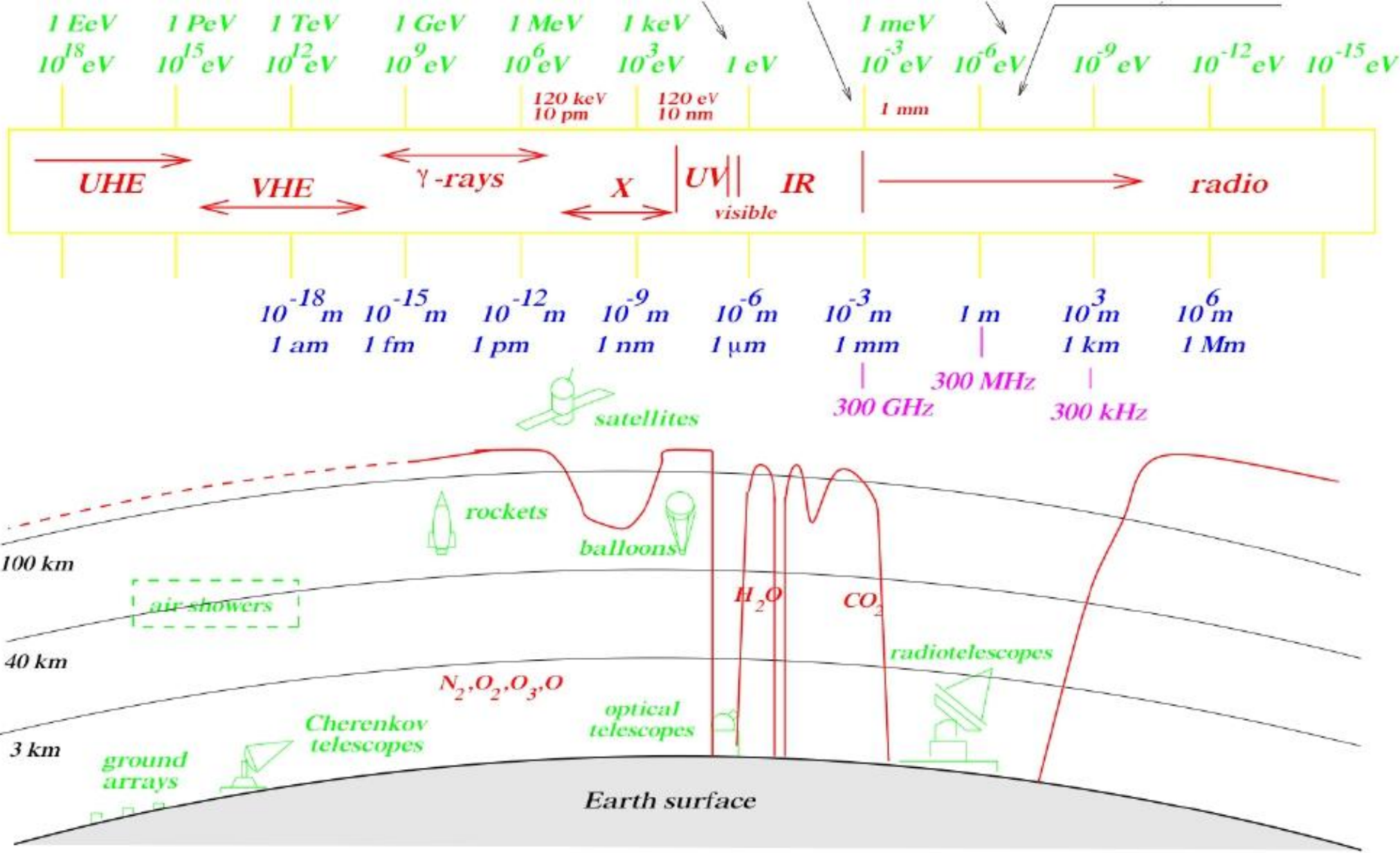

Atmospheric absorption

- There are only two transparent windows due to the absorption and scattering from various particles of the Earth's atmosphere: the optical one at visible wavelengths (300-700 nm) and the radio one at radio wavelengths.
- When the wavelength is smaller than 300 nm, the radiation is significantly absorbed by oxygen atoms, oxygen molecules, and ozone.
- At wavelengths around 1 μm , the major infrared absorption is by water molecules. In the infrared region, water vapor, carbon dioxide, and ozone produce a series of absorption bands, leaving a number of very narrow infrared windows (8-13 mm, 17-22 mm, and 24.5-42 mm).
- The long wavelength part of the radio window is stopped by the ionosphere, between 100 and 50 km above sea level.

Site selection

- Atmospheric turbulence as well as human activity makes different observational conditions for different sites on Earth. In the beginning of modern astronomy development, the telescope sites were near large cities. Gradually, telescopes were moved to far away into high mountain sites. Serious site selection activities started in the early 1950s.
- Many factors influence site selection:
 - Factors related to atmospheric conditions: number of clear nights per year with no or few clouds, seeing, scintillation, rain, snow, wind, atmosph. attenuation.
 - Factors related to natural conditions: altitude, latitude, topology, temperature variation, sand storms, dust condition, earthquake activity.
 - Factors related to human activities: sky brightness, city light, pollution.
 - Factors related to logistics: electricity, water, road conditions, living facilities.

Site selection

- The best astronomical sites are found at high mountains of coastal regions or isolated islands where a cold sea current from the West is dominant.
 - There is less atmosphere above, reducing absorption and attenuation
 - At these sites, the air flow is smooth.
 - Mountain sites are high above clouds, so the number of clear nights without clouds per year is high and the water vapor content is also lower.
 - Such sites are typically farther away from civilization centers
- As of today the best optical sites are Hawaii, northern Chile, the Canary Islands.

5. Beyond optical wavelengths: Radio, Infrared, Ultraviolet, X-Ray and Gamma-ray

- During the last 100 years, astronomers have learned how to research the sky outside the narrow “visible window”.
- Each new window has brought about scientific breakthroughs: for instance we know that black holes or neutron stars exist only because we have radio or X-ray telescopes.
- Each telescope at each window has its own “tricks”.

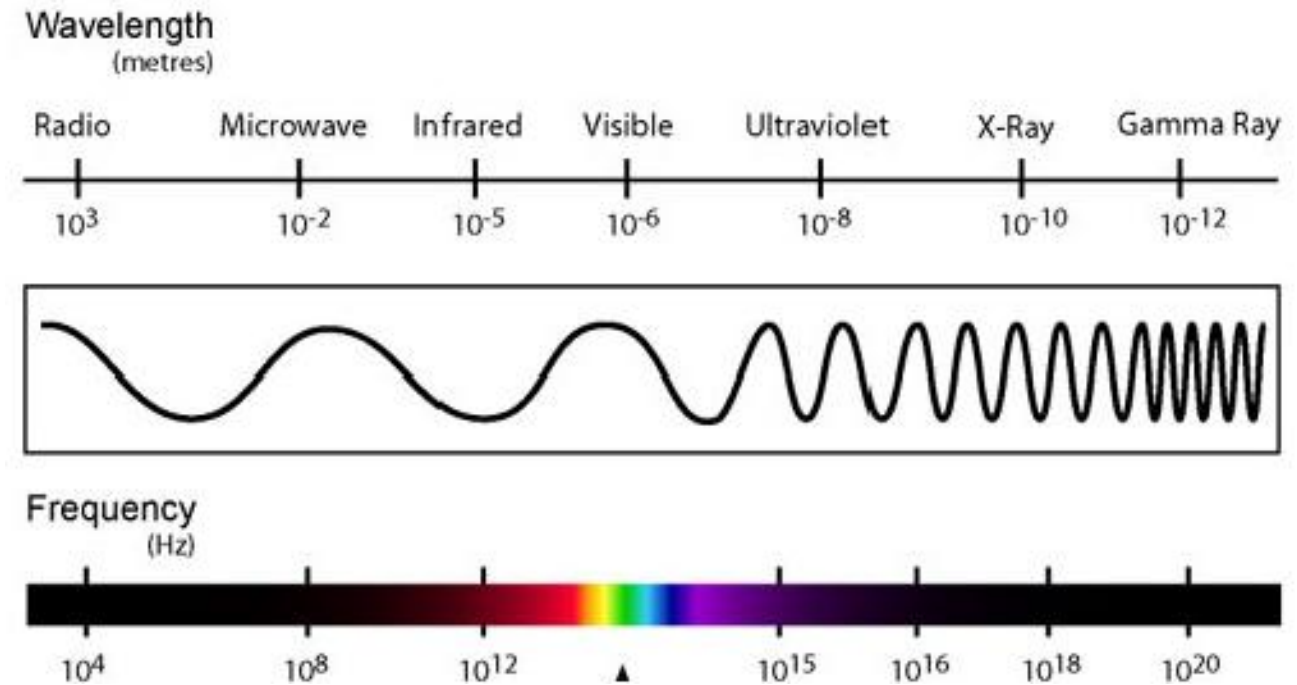

Infrared

- IR: between 0.75 and 350 μm .
- Atmospheric attenuation is caused mainly by molecules of water vapor, carbon dioxide, ozone, methane, nitrous oxide, and carbon monoxide occurring below the tropopause where the troposphere ends and the stratosphere begins.
- The altitude of the tropopause is between 7 and 20 km depending on the location.
- Only in a few narrow wavelength ranges can infrared light make it through to ground level.
- Observations mainly from balloons, rockets or space.

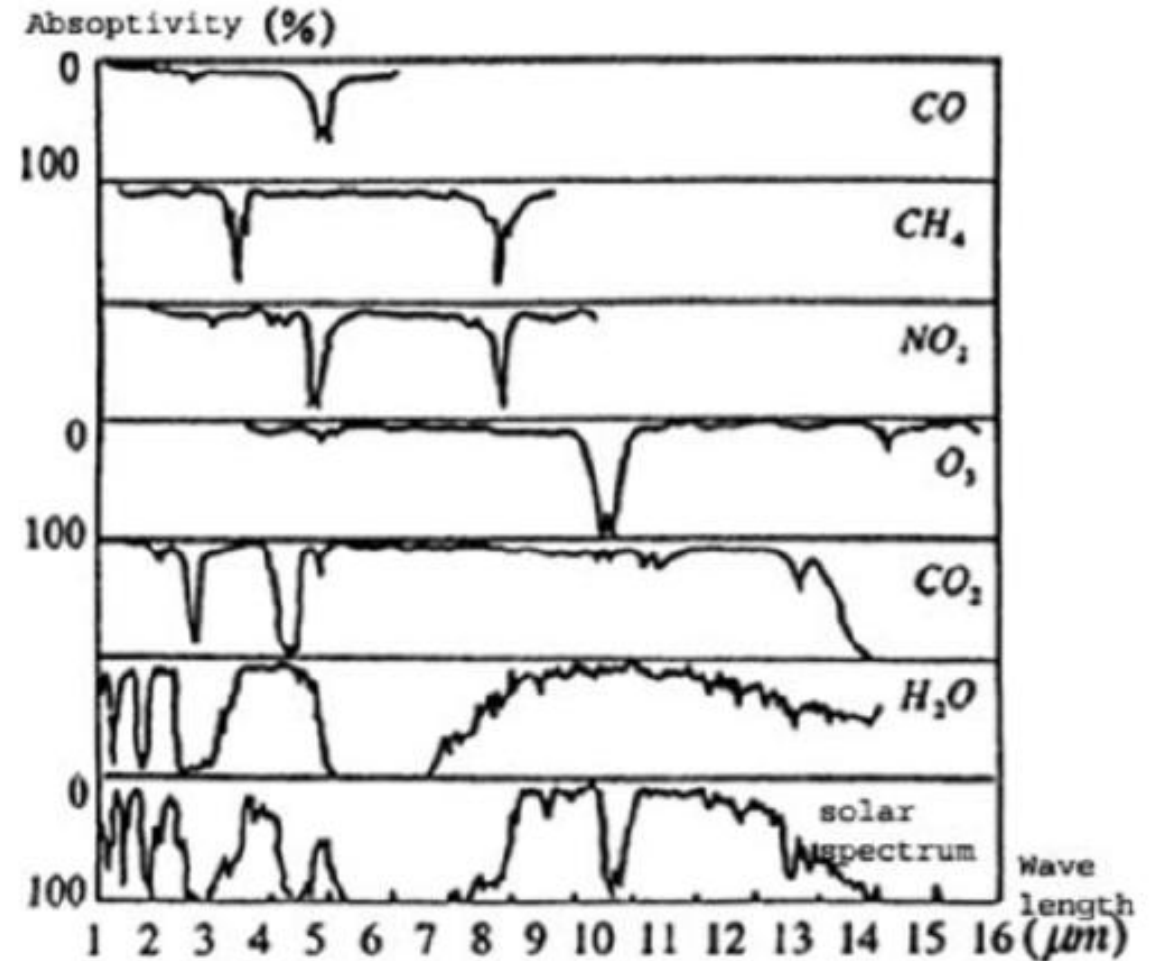

Infrared

- A serious problem with detection of IR is that most of the objects around us emit IR, because they are at $T \sim 30\text{-}300\text{ K}$.
- This includes:
 - The atmosphere, which generates an permanent (generally anisotropic) background.
 - The components in the telescope, like mirrors, supports, detectors, electronics, etc.
- Infrared telescopes usually have a relatively large f/D and a small FOV. With a large focal ratio, the size of the secondary mirror is small. The central aperture blockage and the thermal background noise from the blockage are reduced.

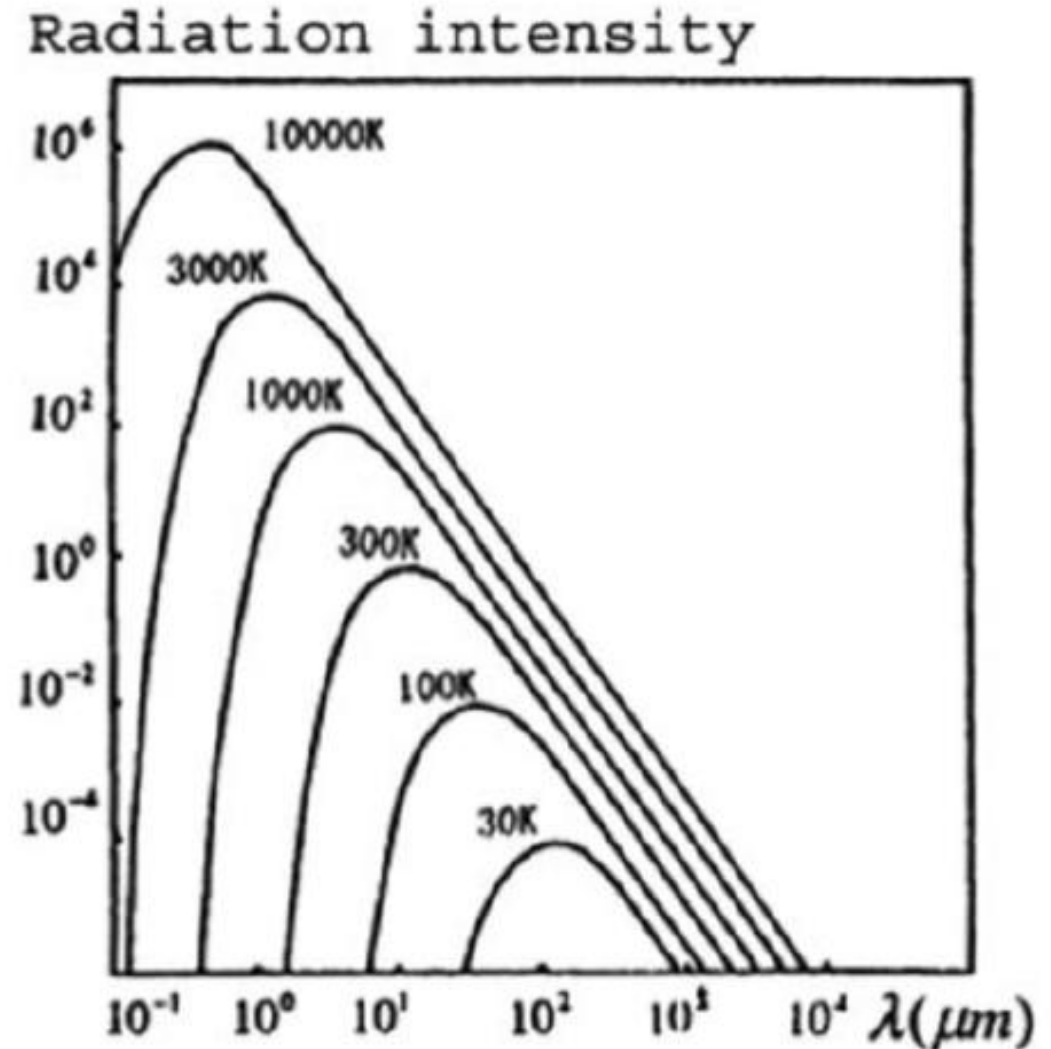

Infrared: Herschel satellite detector

- **Herschel Space Observatory** was built and operated by ESA. It was active from 2009 to 2013, and was the largest infrared telescope ever launched
- 3.5 m primary mirror made by brazing together 12 silicon carbide (SiC) mirror segments. The mirror is the largest silicon carbide mirror ever made. Final mirror weight of 350 kg (ultralight for use in satellite).
- Even in outer space it needed shade from the Sun and active cooling. The 3 instruments were housed in a cryostat filled with more than 2,300 liters of superfluid helium and cooled below 2 K.



Radio

- Any wavelength longer than 1mm is considered radio.
- Large atmospheric window from ~3 cm to ~10 m (10 GHz to 3 kHz).
- Angular resolution is very poor: consider Airy disk $\theta(\text{rad})=1.22 \lambda/d$. For instance, $\sim 0.14^\circ$ for $\lambda=21\text{cm}$ and $d=100\text{m}$ (next slide).
- Radio telescopes can be used at day because the Sun is a weak radio source. Besides, so far the Earth was relatively radio quiet, so any place was ok for a radio telescope, but this is changing fast ...

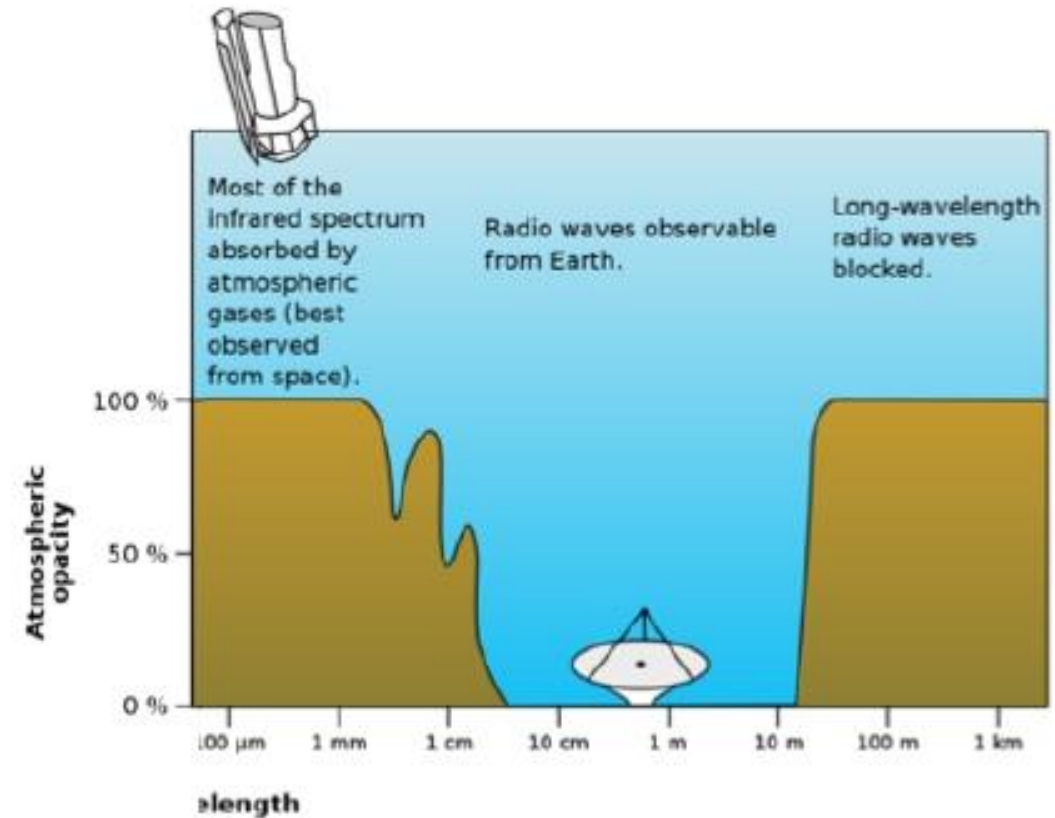

Radio antennas

- The first radio antenna used to identify an astronomical radio source was one built by K.G. Jansky (Bell Labs) in 1932 at 20 MHz. Jansky was assigned the job of identifying sources of static that might interfere with radio telephone service. He found that one of the sources of static was the galactic center.
- An amateur radio operator, G. Reber, built the first parabolic "dish" radio telescope, $d=9\text{m}$ in his backyard in Illinois in 1937. First map of the sky.
- After WWII the developments in radar generated lots of technology that could be used for radiotelescopes and the field grew quickly.
- Paraboloidal reflector antennas remain the most common type of radio telescopes today. Small short $f/d < 1$ because aberrations are small compared to diffraction.



The Effelsberg $d=100\text{m}$, $f=30\text{m}$ radio telescope in Germany

Very high resolution using interferometry

- Individual antennas have very poor angular resolution, but one can use a totally different technique to determine direction of radio sources: interferometry.
- If wave crests come at the same time: positive interference and maximum signal. As angle changes, the added signal gets weaker and weaker.
- Angular resolution now depends on $\lambda/\text{baseline}$ and the baseline can get as long as many km.

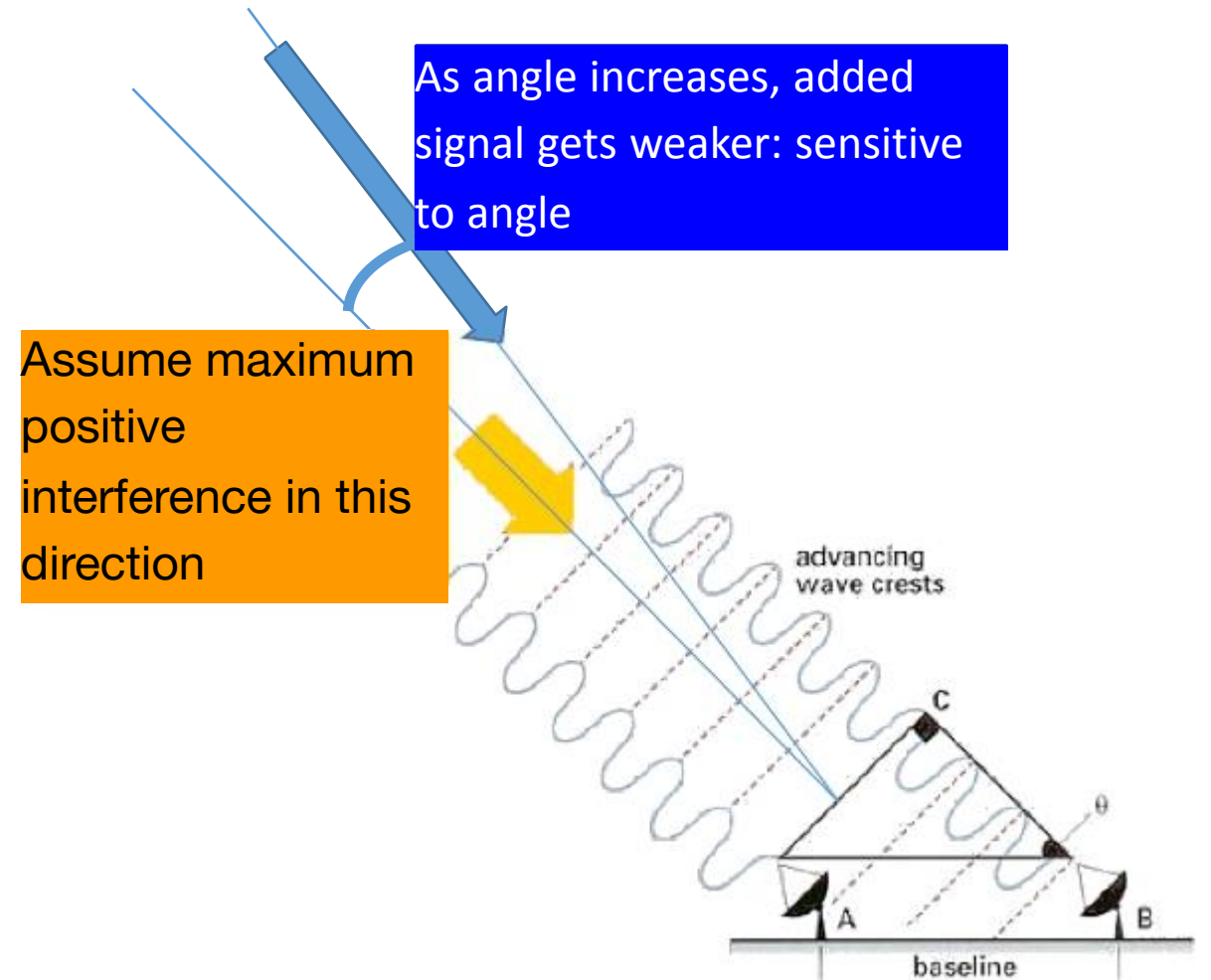

Very high resolution using interferometry

- In 1972, the Very Large Array (VLA) project in New Mexico was approved in the US. This large radio interferometer has 27 movable antennas each having a diameter of 25 m.
- Arrays with baselines in the order of 1000's km are operated. For instance the European VLBI network (EVN), reaches angular resolutions below 0.2 **milliarcsec**, the best in astronomy



VLA, Socorro, New Mexico

Array	90 cm	18cm	6cm	3.6 cm	1.3 cm	0.7cm
EVN	-	15	5	3	1	0.6
EVN (inc. Sh/Ur)	30	5	1.5	1	0.3	0.15
EVN+VLBA	19	3	1	0.7	0.25	0.13

EVN Angular resolution in mas



Ultraviolet

- UV: wavelengths from 10 to ~400 nm.
- The atmosphere absorbs almost all UV radiation except that with wavelengths between 310 and 400 nm, mostly due to the ozone layer
- In the near ultraviolet (NUV) regime (200--400 nm), astronomical observations are similar to those in the optical regime.
- Higher energy UV radiation is named extreme ultraviolet (EUV), or vacuum ultraviolet (VUV). The wavelength is in the range 10 to 200 nm.
- The observations in this higher energy UV regime are similar to those in the X-ray regime.

X-rays

- The wavelength of X-rays is from 0.01 to 10 nm, which is about the size of an atom. The corresponding photon energy is 120 eV to 120 keV.
- No X-rays penetrate to the ground. X-rays have more energy than the binding energy of electrons in any material, so they are absorbed. Observations mainly made from space.



ESA's XMM X-ray telescope

Reflectors for X-ray or UV telescopes

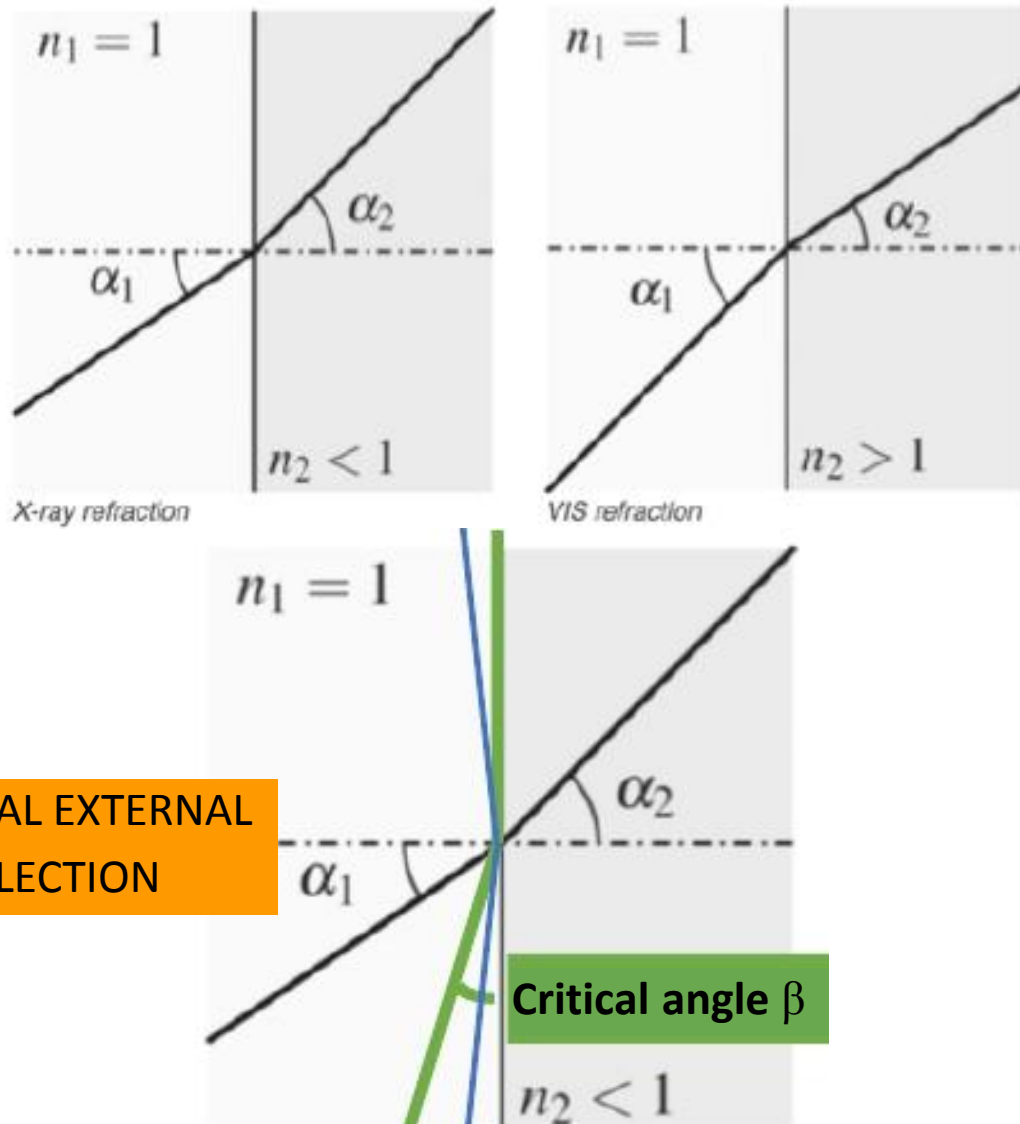

- In the X-ray regime, the indices of refraction of all materials are slightly less than unity ($v > c$), so that a **lens** optical system for X-ray observation is **impossible**.
- On the other hand, X-rays are absorbed: standard reflection is not possible either (reflectivity=0%).
- Only chance to reflect in the following: since $n < 1$, there is a critical angle β for which the photon would be refracted parallel to the surface. Beyond that angle, photons suffer “Total **External Reflection**”.

Photon beyond β is total-externally-reflected

TOTAL EXTERNAL REFLECTION

Critical angle β

Reflectors for X-ray or UV telescopes

- Mirrors must be almost parallel to incident UV or X photons: “grazing optics”.

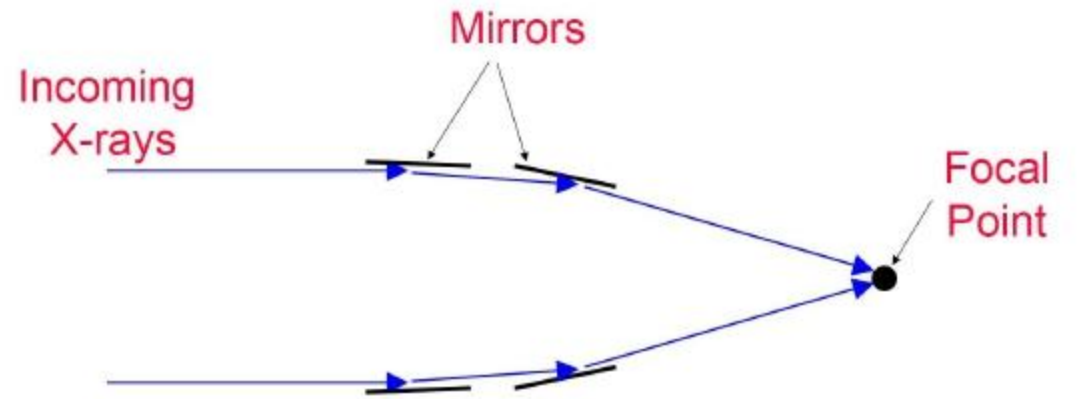
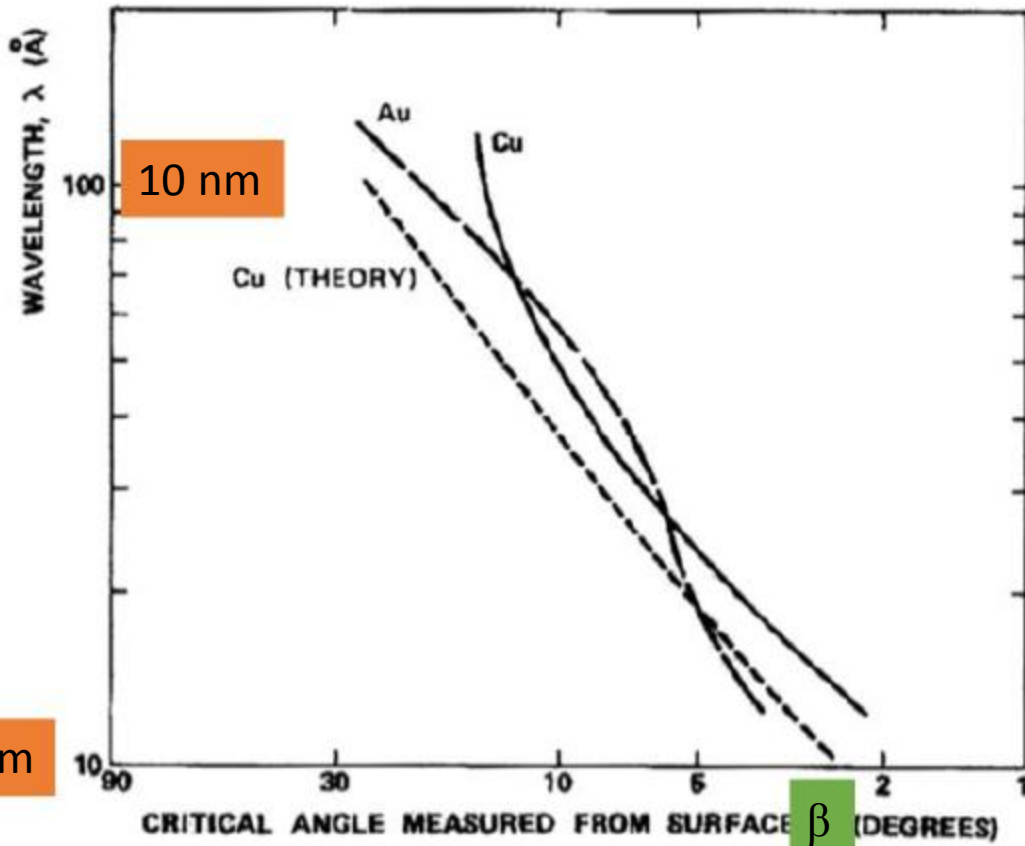

A “Wolter telescope”

Reflectors for X-ray or UV telescopes

One can combine several nested mirrors to collect even more X-rays

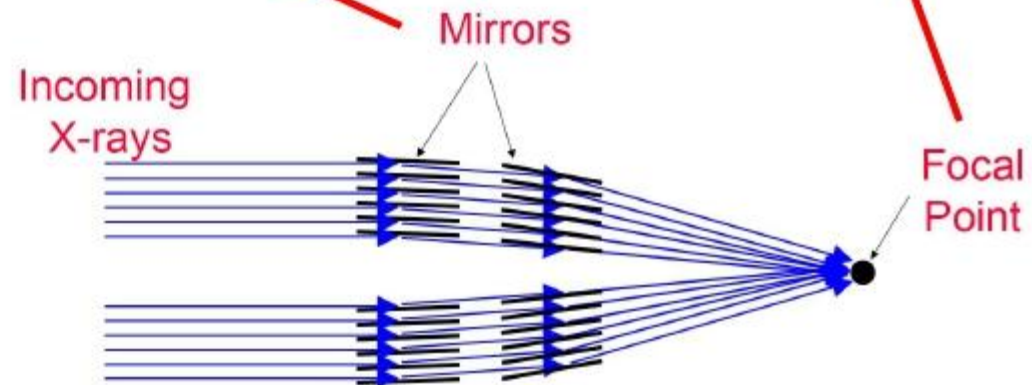
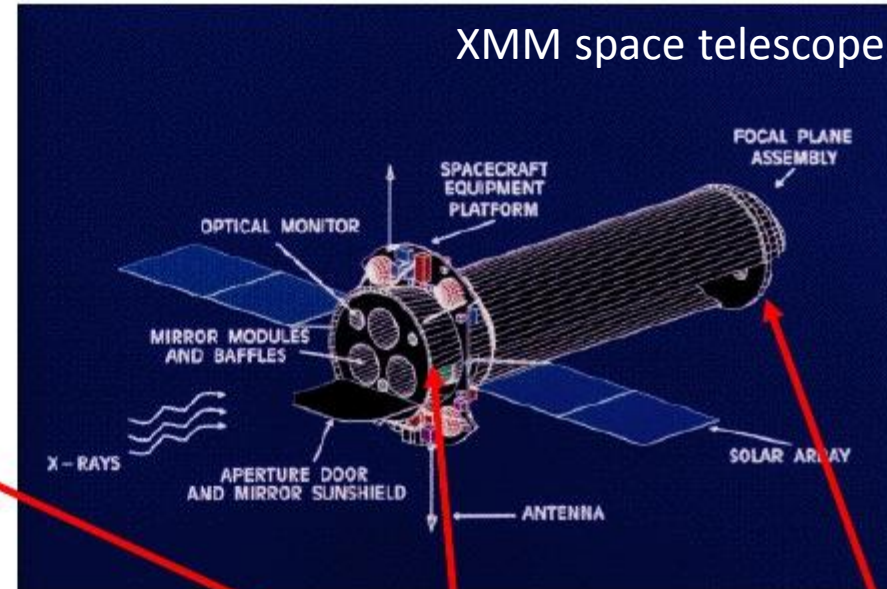

Gamma ray telescopes

- Normally, the wavelength is smaller than 0.001 nm, the photon energy is higher than 1.2 MeV. However, there is no clear division between X-rays and gamma rays.
- Absorption in the atmosphere is even stronger than X-rays so they are generally observed from space.
- Neither lenses nor mirrors work, so gamma rays do not go through conventional optical systems.

Interaction of high energy photons with matter

Photons suffer different processes depending on their energy.

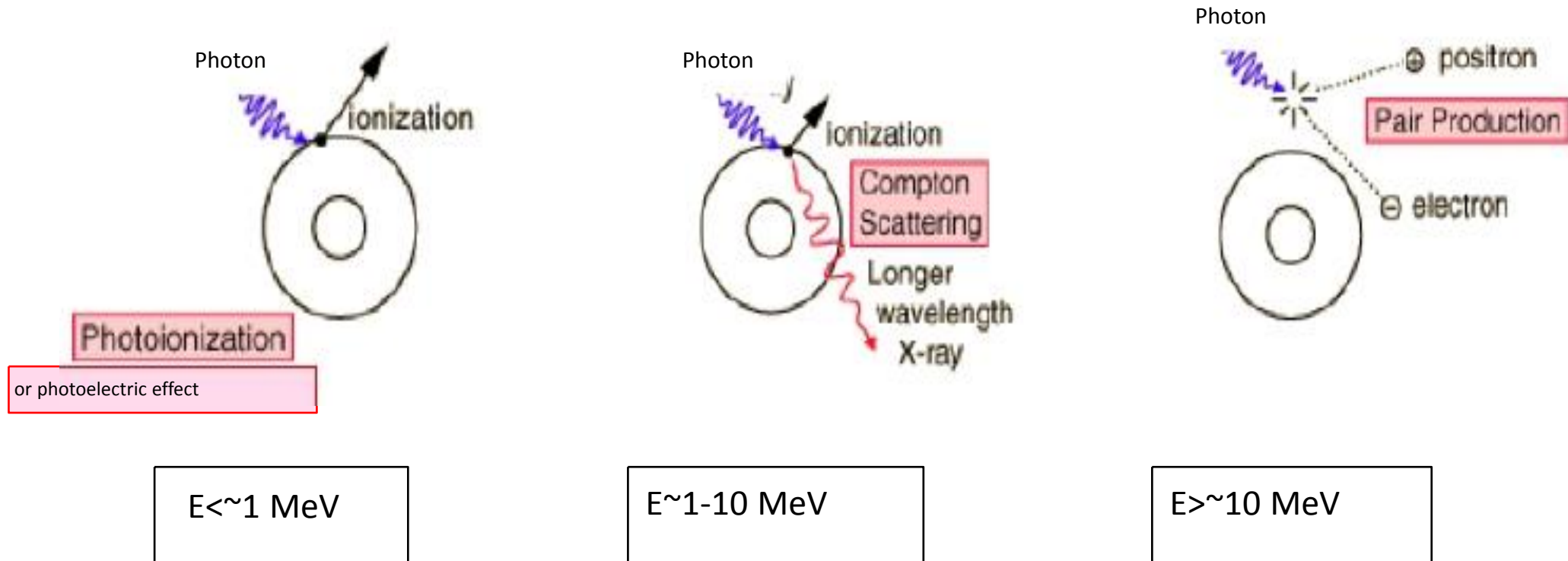

Gamma ray telescopes based on pair production

- For >10 MeV gamma ray detectors are based on the pair-production process.
- Conversion foils: layers of heavy material to turn γ -ray into an e^-/e^+ pair
- Particle trackers: layers of “particle detectors”: e^- and e^+ produce charge in these layers and the detector can tell where exactly they went through. So we can find out the direction of the incident γ -ray.
- Calorimeter: a very heavy material so that all e^- and e^+ are absorbed. The signal they produce allows to estimate the energy of the incident γ -ray.

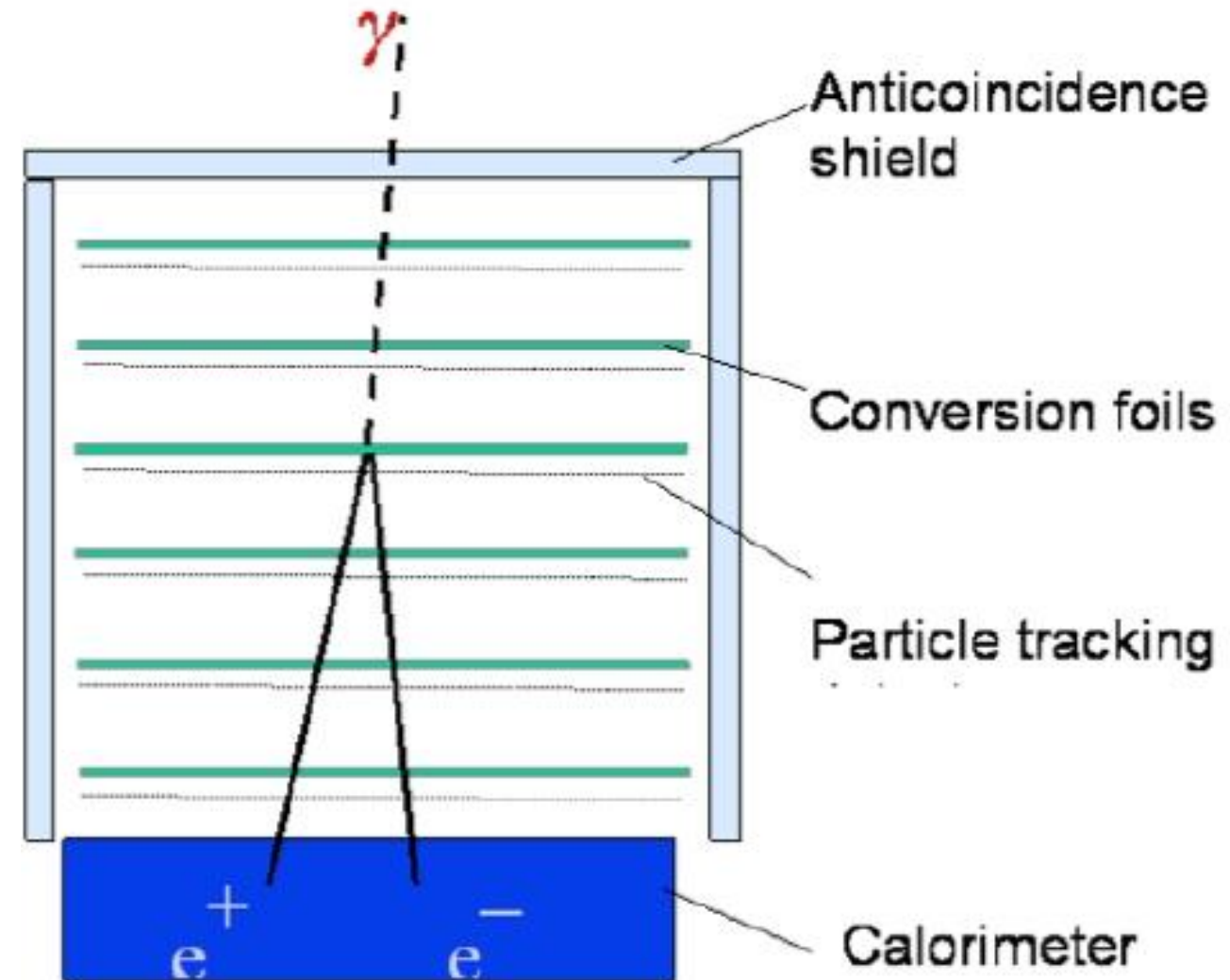

Gamma ray telescopes for GeV-TeV energies

- Beyond a few GeV energies γ -rays have so much energy that they leave a “trace” in the atmosphere: they generate a “cascade” of secondary particles (“extended air shower”).
- Secondary charged particles produce “Cherenkov light” at near UV/blue wavelengths. So-called “Cherenkov telescopes” detect that light to determine direction and energy of incident γ -ray

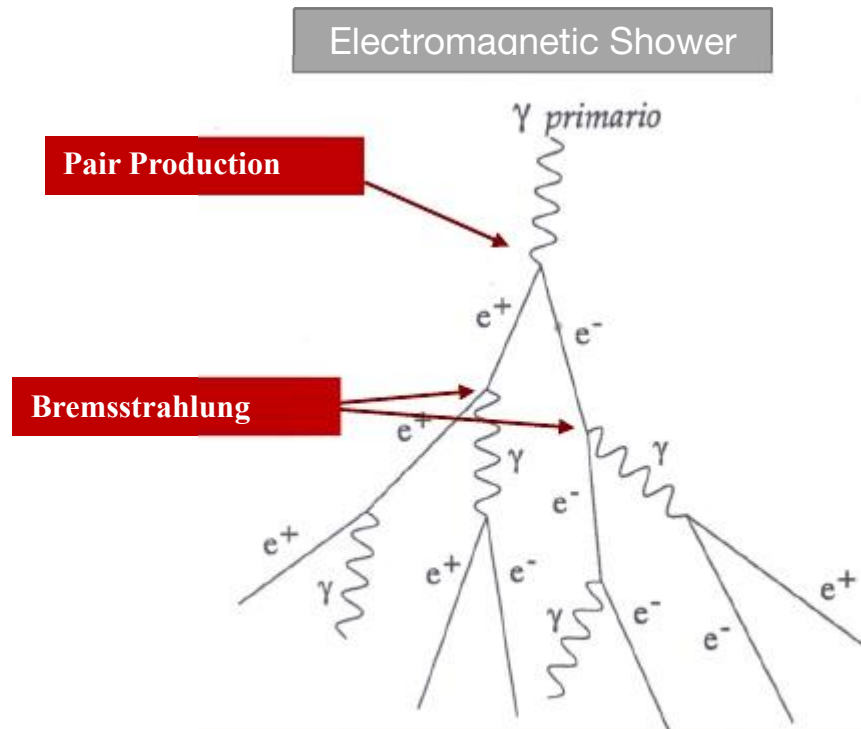

At $E < 1$ MeV, γ -rays lose energy via Compton & photoelectric, and e^-/e^+ lose energy via ionization. Eventually all particles and γ -rays are absorbed and the shower ends

Gamma ray telescopes for GeV-TeV energies

- Beyond a few GeV energies γ -rays have so much energy that they leave a “trace” in the atmosphere: they generate a “cascade” of secondary particles (“extended air shower”).
- Secondary charged particles produce “Cherenkov light” at near UV/blue wavelengths. So-called “Cherenkov telescopes” detect that light to determine direction and energy of incident γ -ray

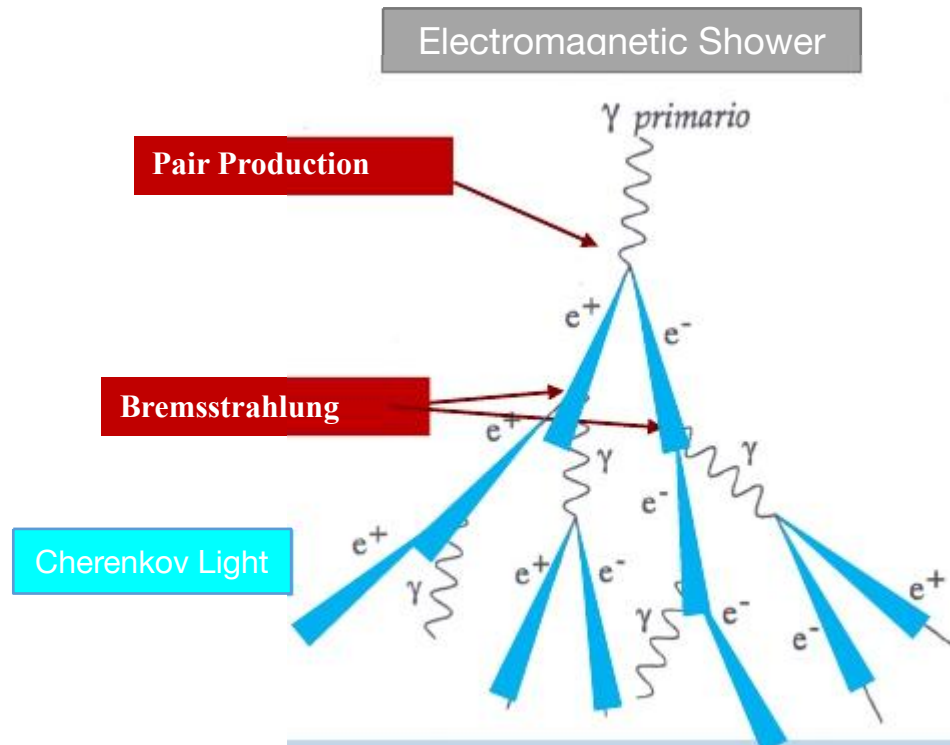

At $E < 1$ MeV, γ -rays lose energy via Compton & photoelectric, and e^-/e^+ lose energy via ionization. Eventually all particles and γ -rays are absorbed and the shower ends

6. Mirror Manufacturing

- Mirrors are used in many applications implying different requirements.

Relevant aspects are:

- Reflectivity (one of the main aspects)
- Size and weight (impact on telescope design)
- Coating (to prevent damage due to environment)
- Cost (we need many...)
- Manufacturing technologies (influences previous aspects)

Manufacturing Technologies

- All-aluminium mirrors
 - Aluminium structure
 - Reflective surface generated by precision diamond milling
 - Quartz protection layer

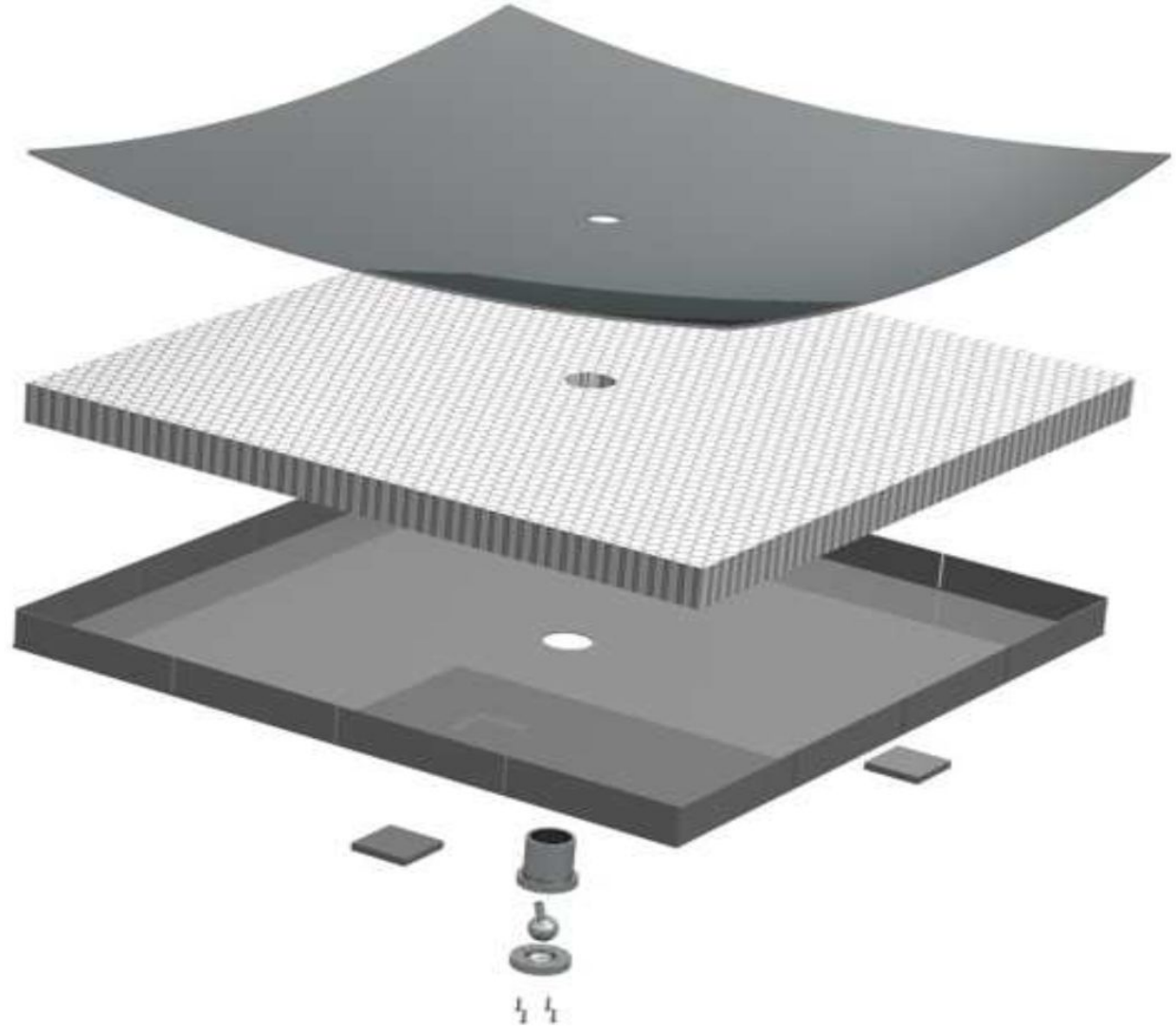

Manufacturing Technologies

- Glass-aluminium mirrors
 - The center of the mirror is an Aluminium honeycomb structure that provides the needed rigidity but is light weight.
 - On both sides, a glass sheet is glued with epoxy in order to obtain a sandwich.
 - The sandwich is deformed to retain the shape imparted by a master with convex profile. If the radius of curvature is large, the sheet can be pressed against the master using vacuum suction. Some spring back must be taken into account.
 - After releasing the vacuum, on the concave side, a reflecting coating (Aluminum) and a thin protective coating (Quartz) is deposited.

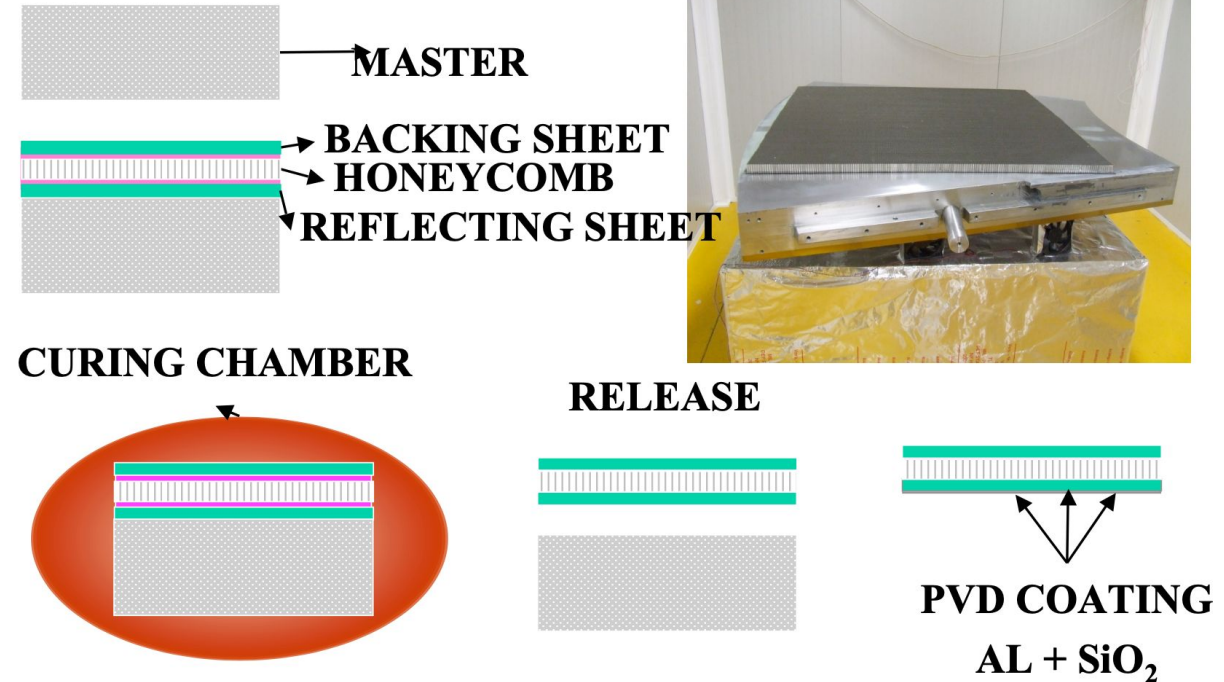

Manufacturing Technologies

- Composite mirrors
 - Carbon fibre/epoxy based substrates
 - Several options:
 - Sandwich design: Front and a back sheet of the same material, the front having been shaped on a mould. A thin glass sheet with a reflective coating is glued to the front side.
 - Monolythic: Made as a single part and of one material. The spherical surface is formed by an in-mould coating process (IMC) during the forming process and later coated with reflective aluminium
 - Open structure: Two flat panels separated by perforated aluminium tubes. The spherical epoxy layer is formed on the front panel using a master surface.

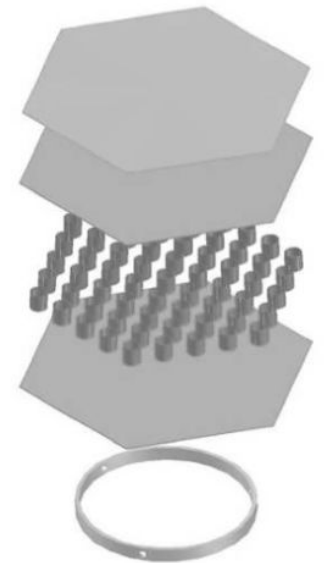
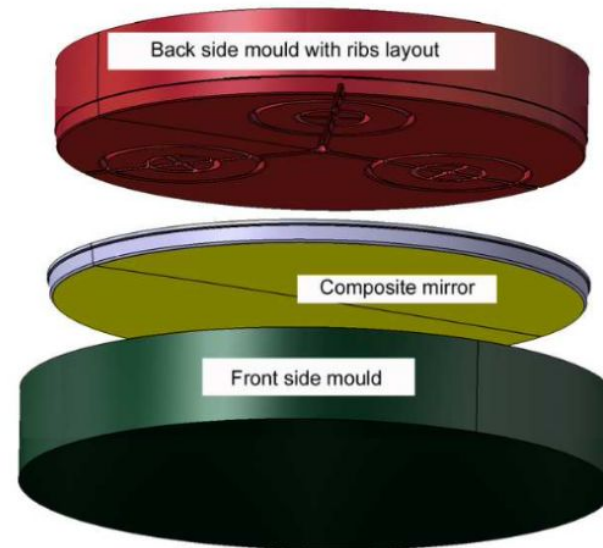
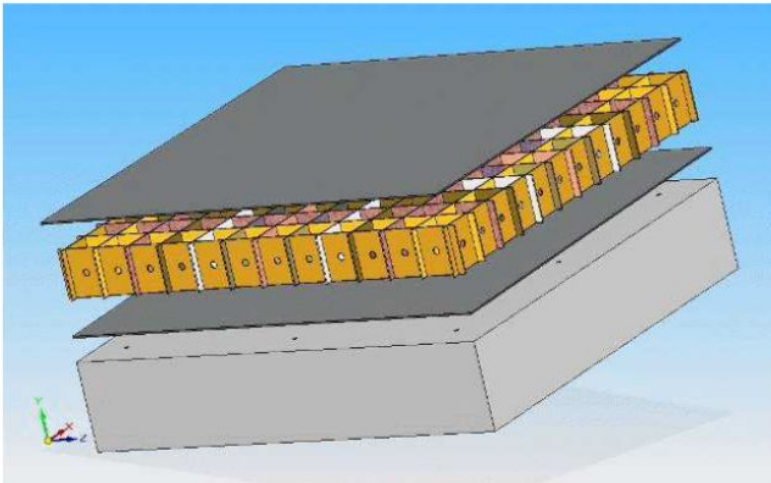

Coating

- Relevant both for optimal reflection and protection
- Reflectance depends on the wavelength, the choice of the coating material depends on the light wavelength that needs to be reflected.
- Mirror degradation reduces performance of the telescope and needs to be minimized. A possibility to counteract degradation is to re-new reflective surface.
- Protective coating options
 - Vacuum deposited SiO_2
 - Al_2O_3 obtained by anodizing the reflective Al layer
 - Multilayer dielectric coatings of alternating layers of materials with low and high refractive index
 - Purely dielectric coatings without any metallic layer
 - Ultra-thin glass sheet (Gorilla glass)

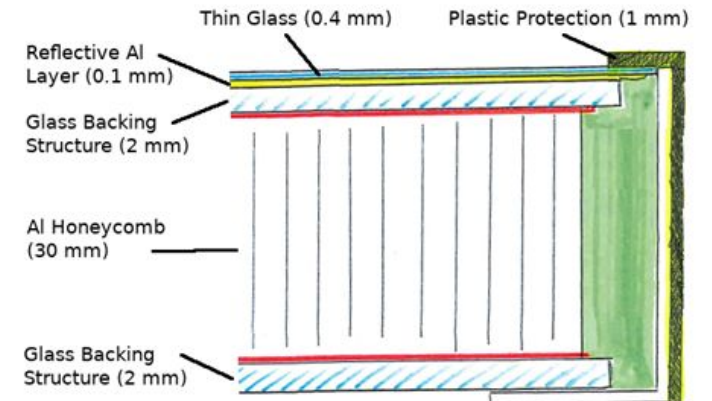

7. Telescope Structure

- Outline
 - Mount Types
 - Choice of Materials
 - Protective Dome



1600s



2010

Telescopes



2030 – 30 meter telescope

Telescopes - All Shapes and Sizes



Personal
Sizes



Current Scientific
Observatory

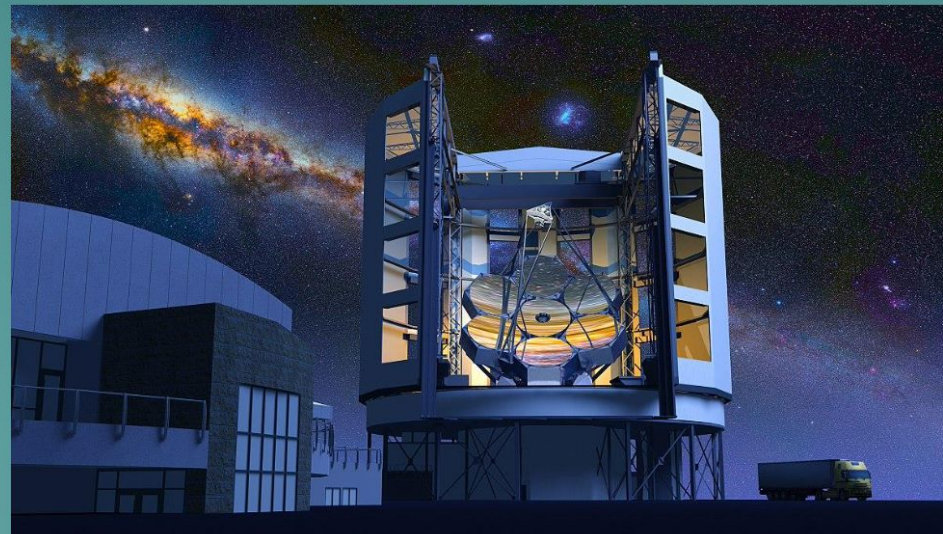

Future

Types of Telescope Mounts



NexStar 11 GPS
Complete Go-To with integrated
Global Positioning System
and computer hand control



**Dobsonian
Alt-Azimuth**

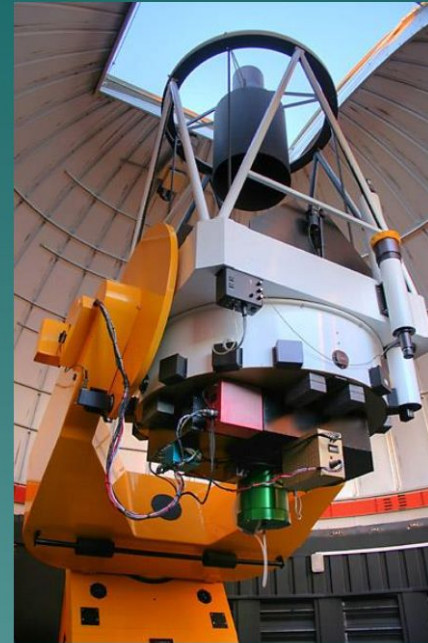

Fork mount

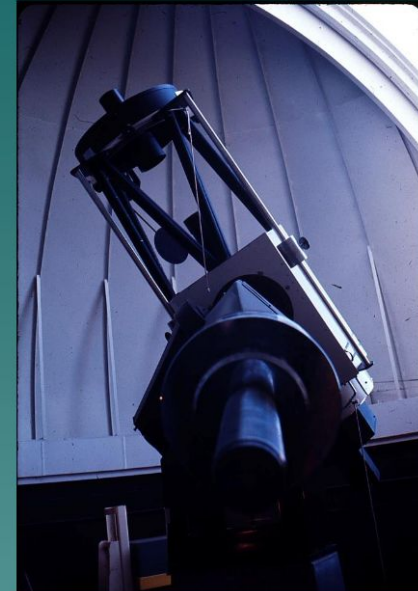

German Equatorial

- Altitude-Azimuth mount (Alt-Az)
- Moves in altitude (up and down) and azimuth (left and right)
 - Requires two motors to track
 - Field of view rotates
 - Has a blind spot at the zenith

Equatorial Mounts

- Aligned with earth's rotational axis.
- German Equatorial - Long arm with counterweights
- Moves east-west, north-south
- Requires one motor to track

Field Rotation with Alt/Az telescopes



Field Rotation over 24 Hours

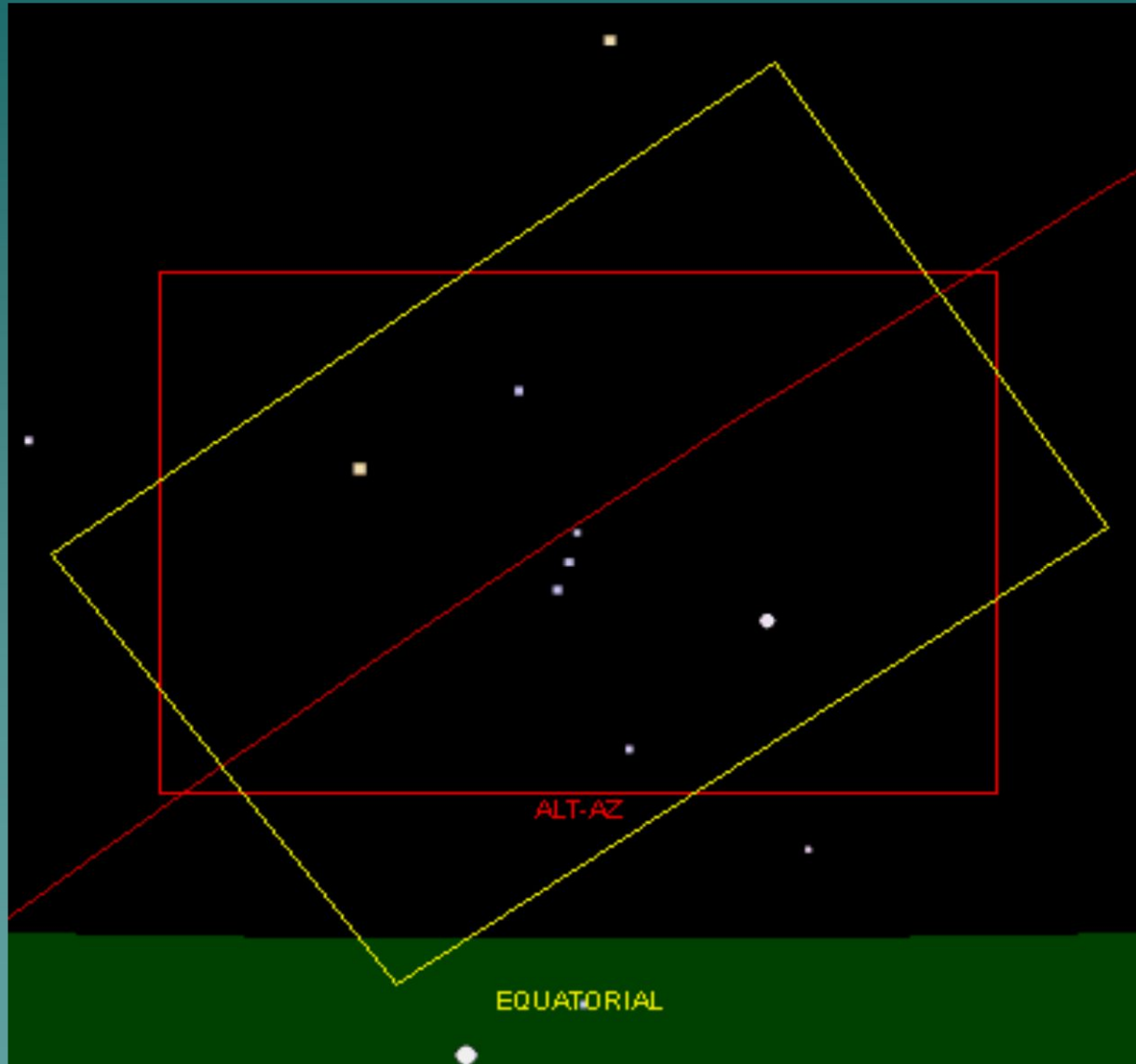

- Observer's latitude
- Right ascension and declination of object
- Earth's sidereal motion

Field Rotation – Looking in an Eyepiece

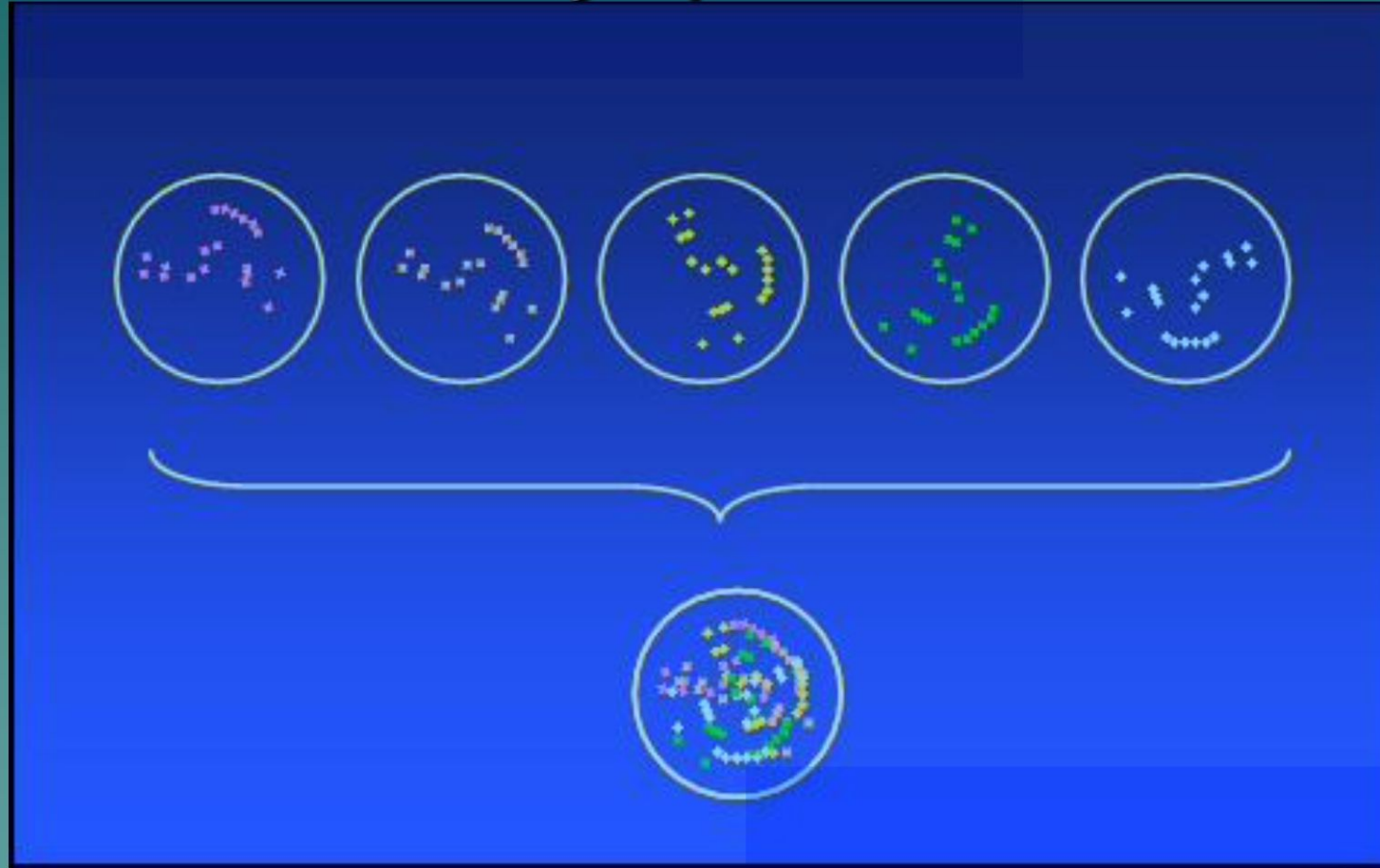

The star will be centered, but surrounding stars will rotate.

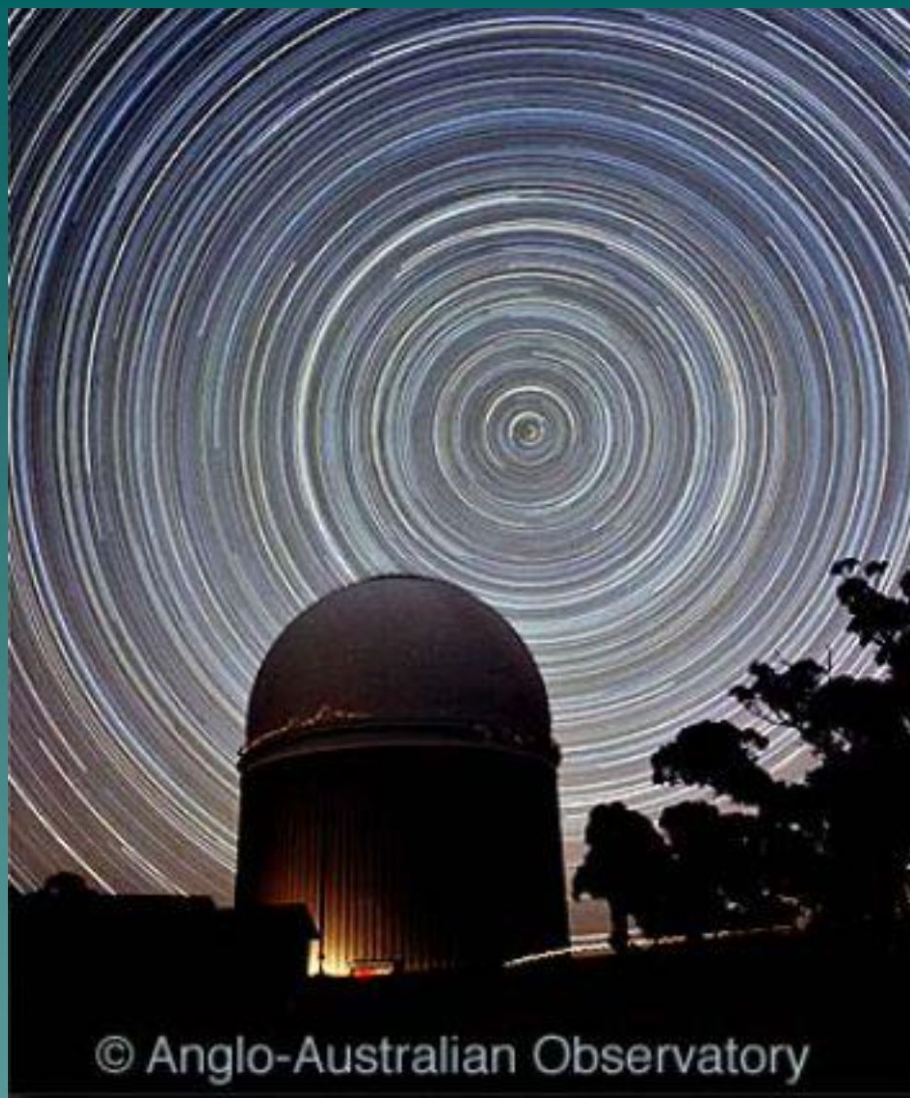

Effects of Earth's rotation

Equatorial Telescope Mounts

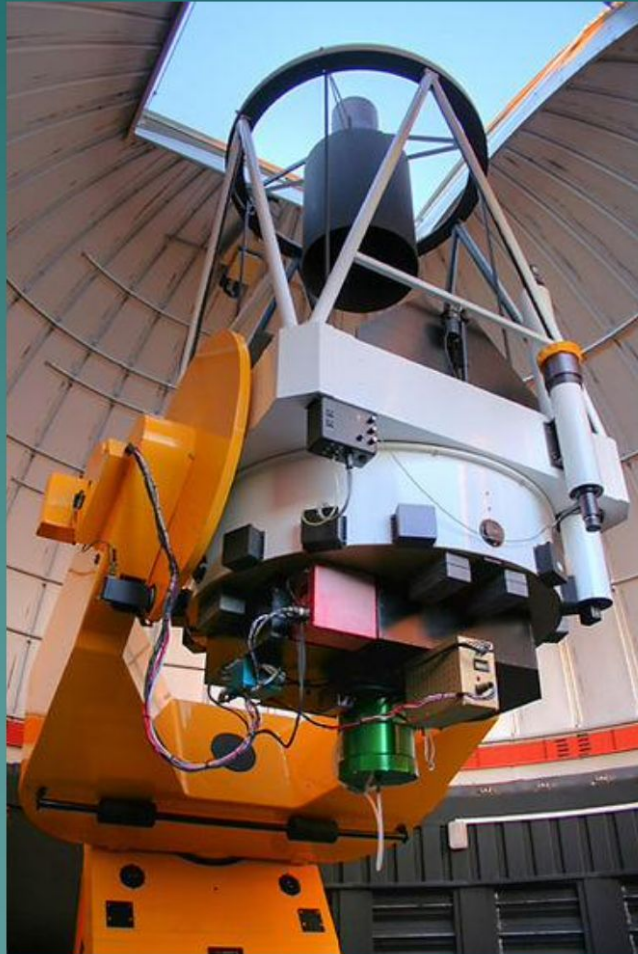

Choice of Materials

- The choice of material has an impact on two major aspects of the telescope
 - The weight of the telescope and the inertia of the movement. Depending on the requirements on the speed of the repositioning, a low weight and favorable weight distribution is desirable.
 - The stiffness of the telescope. The optical properties of the telescope depend on the flexibility of the structure. The more flexible the structure, the more care must be taken (by using additional systems) to keep the optics aligned.
- Using steel improves the stiffness, meaning the mirror facets of the telescope may not need any refocussing for a long time. On the other hand, the weight of steel is quite high and care must be taken against corrosion.
- Using different materials and composite materials like Carbon Fiber Reinforced Plastics (CFRP) or similar, as well as Aluminium and other light metals, can significantly reduce the weight and inertia. The drawbacks are lower stiffness, potential issues with different thermal expansion, increased cost.
- High weight and inertia can be counteracted by powerful motors, while low stiffness can require a complex system of optical alignment. Both increasing the complexity and cost.

Protective Dome

- Besides protecting the telescope from the environment, a second important function is climate control.
- Several aspects determine the dome design:
 - The dome can co-rotate with the telescope, rotate independently of the telescope, or not at all.
 - The size of the slit opening and other vents determine how quickly the telescope can acclimatize and impacts the seeing and the quality of the observations.
 - The size and weight of the dome can make a complex system necessary to open and rotate the dome.
- During the day, the inside can be cooled to minimize temperature differences and thermal expansion at night
- If no dome is used, the telescope systems need to be designed to withstand strong wind, rain/ice/hail, UV radiation, dust intrusion, temperature changes, etc.

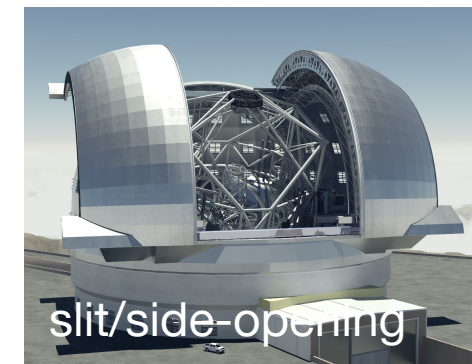
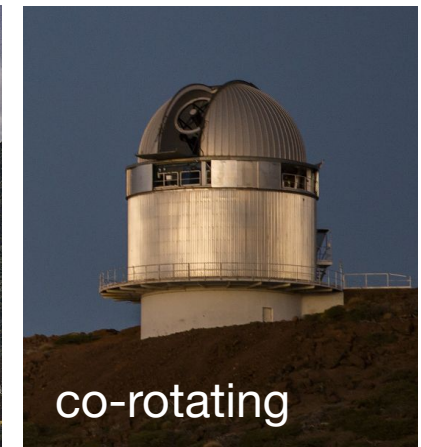

8. Camera

- Outline:
 - Why “PHOTO” detection?
 - Photomultiplier Tubes (PMTs)
 - Solid State Detectors
 - CMOS
 - SiPM
 - CCDs

Why "PHOTO" detection

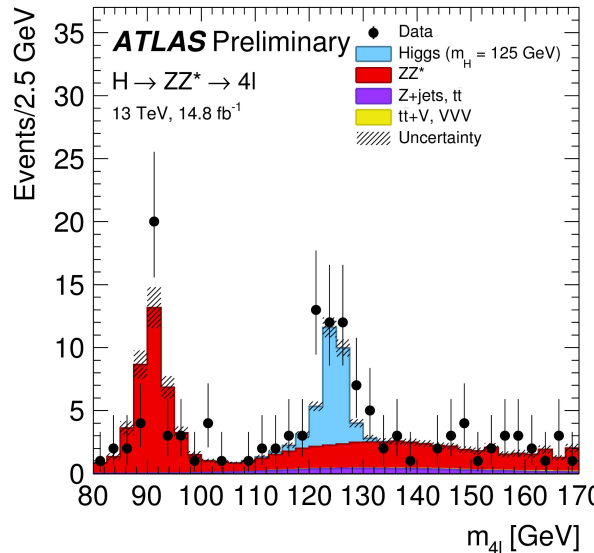
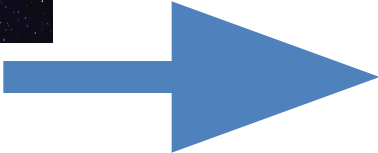
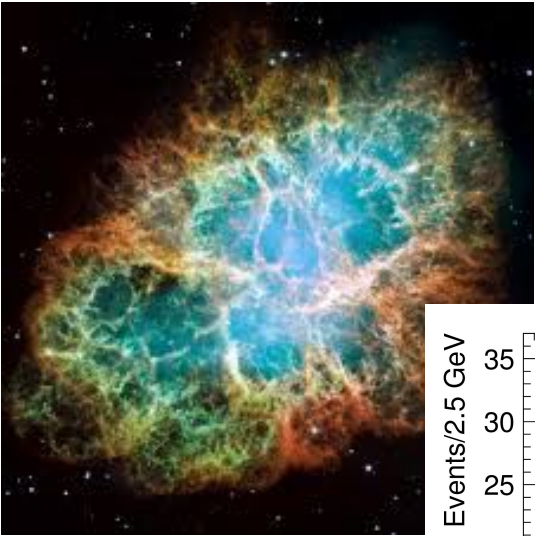

Why “PHOTO” detection

- Purpose: Convert light into detectable **electronic signals**
- Common requirement: high sensitivity

Quantum Efficiency (Q.E.) = Efficiency to transform photons in electrons

- Main types of Photodetectors:
 - Vacuum based devices
 - Gas based devices
 - Solid state detectors

Why "PHOTO" detection

Scintillator

Luminescence

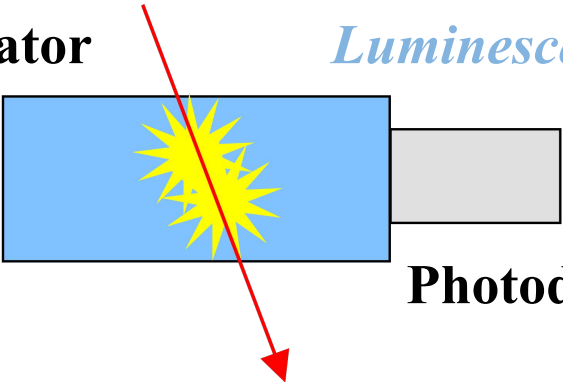

Photodetector

Atmosphere

Cherenkov light

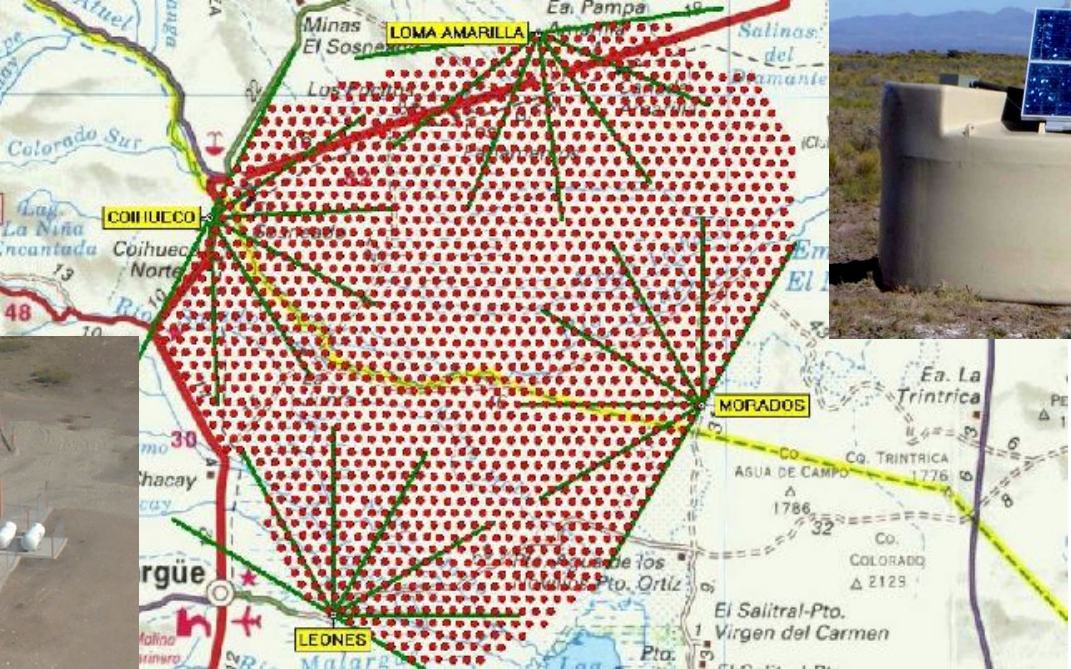

Fluorescence

Mirror + Photodetector

**Water +
Photodetector**

Photomultiplier Tubes

- The Photoelectric effect

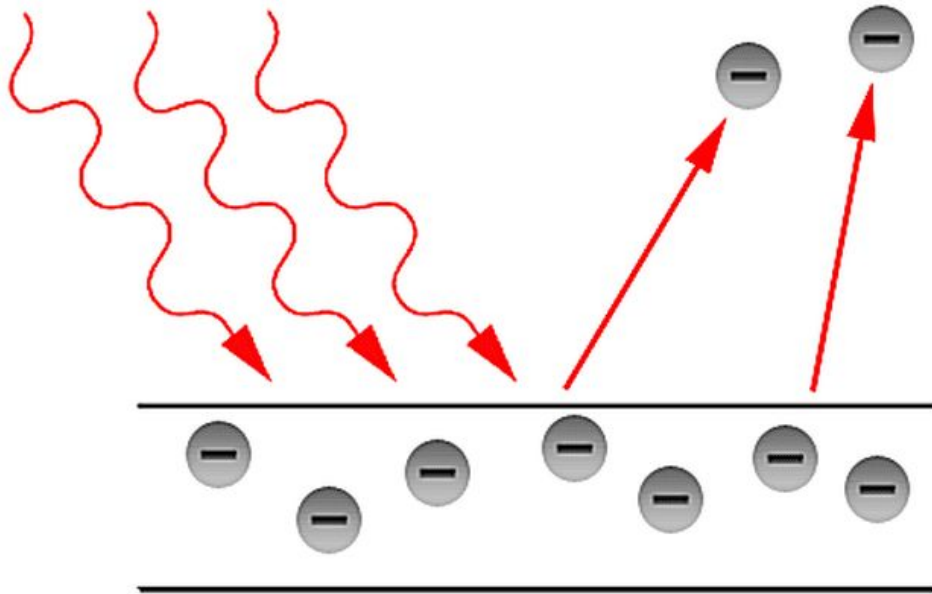

- 1905, Albert Einstein
- Quantum efficiency?
- Does it happen for all kind of light?
- What can we do with the emitted electrons?

Photomultiplier Tubes

- Quantum Efficiency (QE) for different materials as function of wavelength

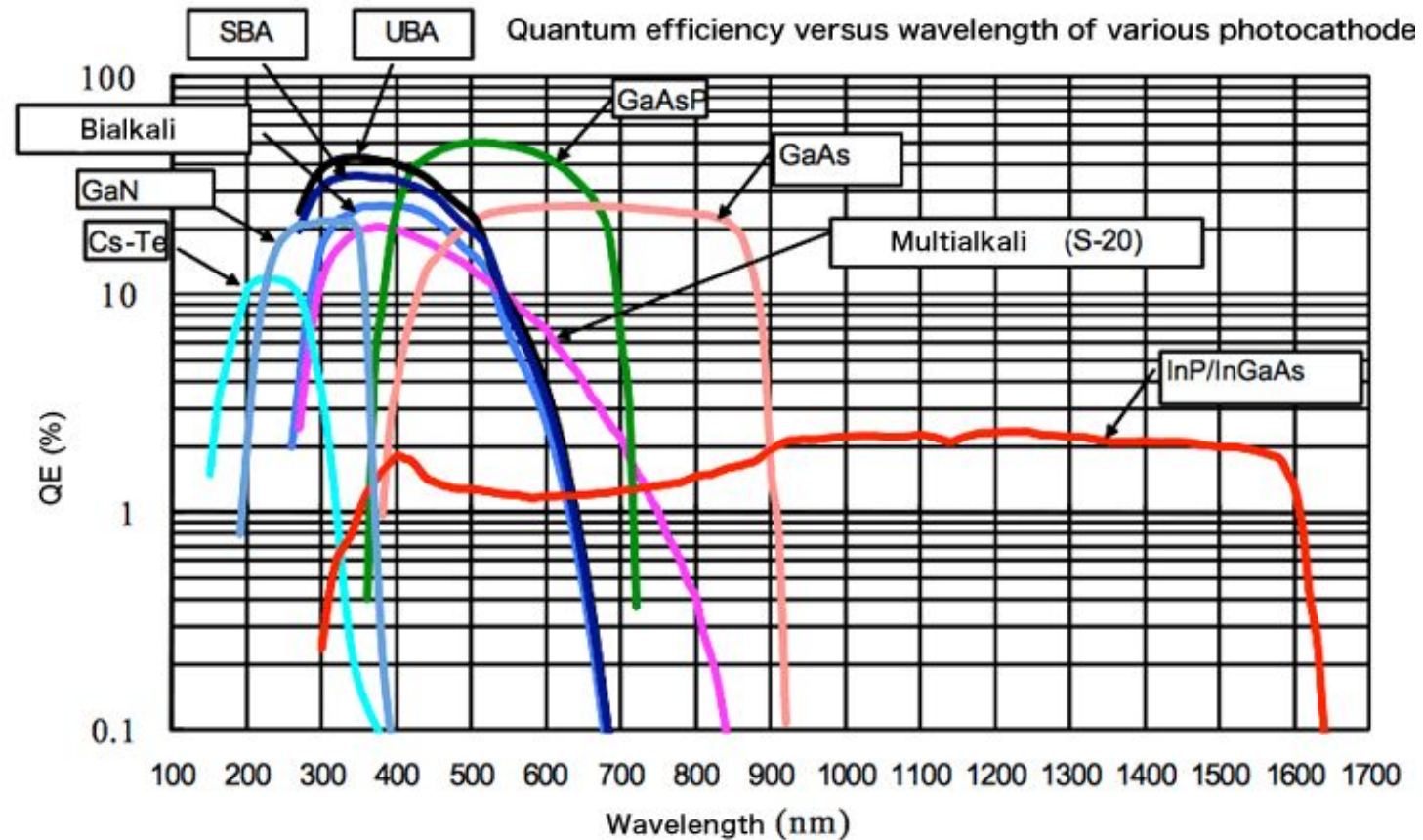

Photomultiplier Tubes

- Vacuum tubes

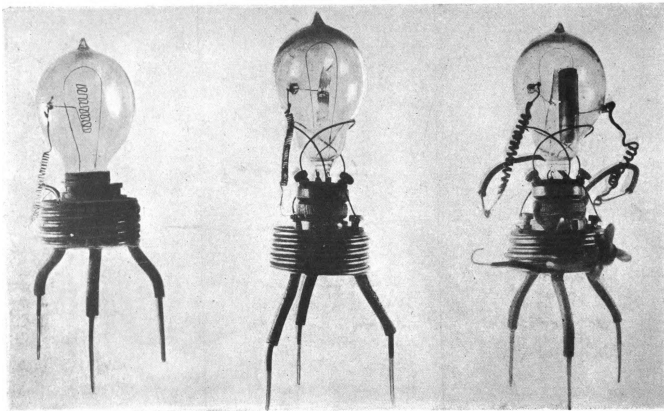

Diodes



Triodes



Voltage Regulator



Cathode ray tube

From 1940s, state solid components have steadily substituted them, but ...

Photomultiplier Tubes

- Photomultiplier tubes are still used to detect photons



Photomultiplier Tubes

- Photomultiplier tubes are still used to detect photons

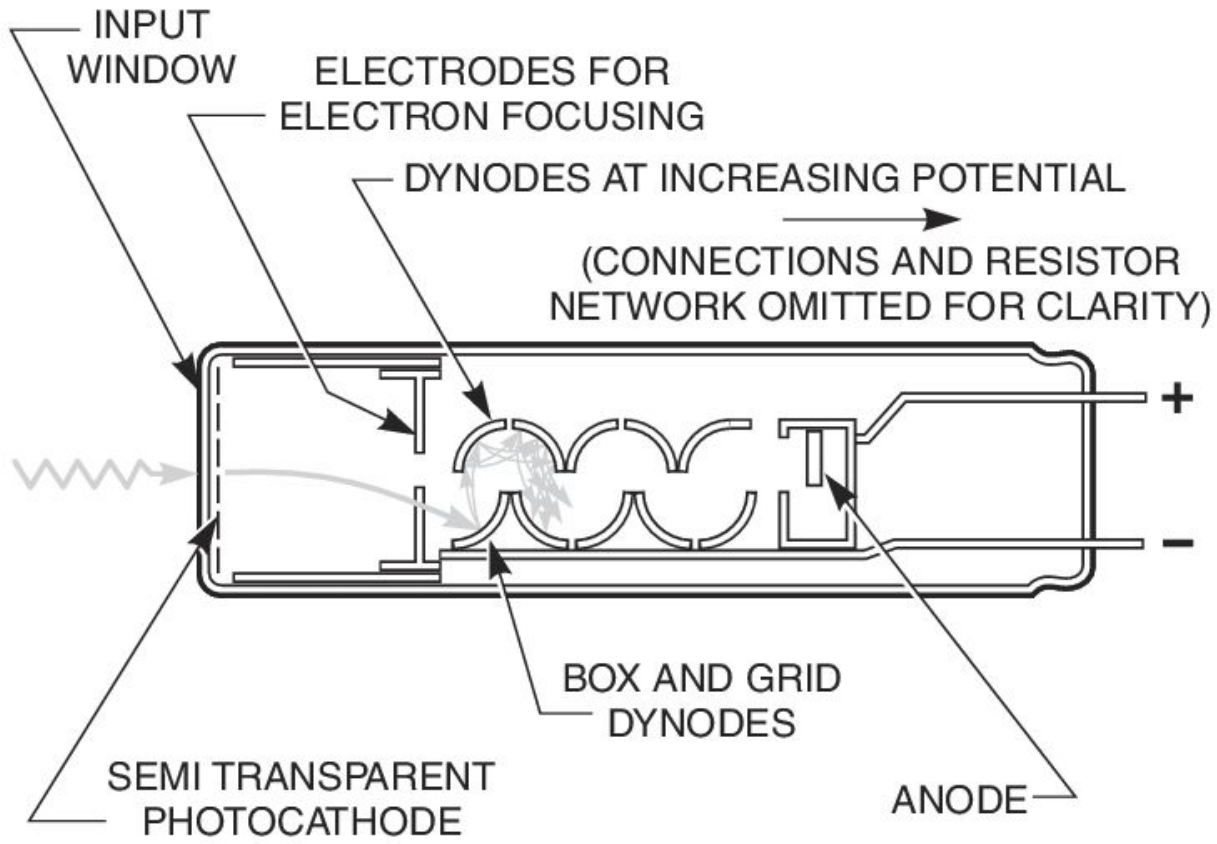

Photomultiplier Tubes

- Conversion of photons to (photo)electrons

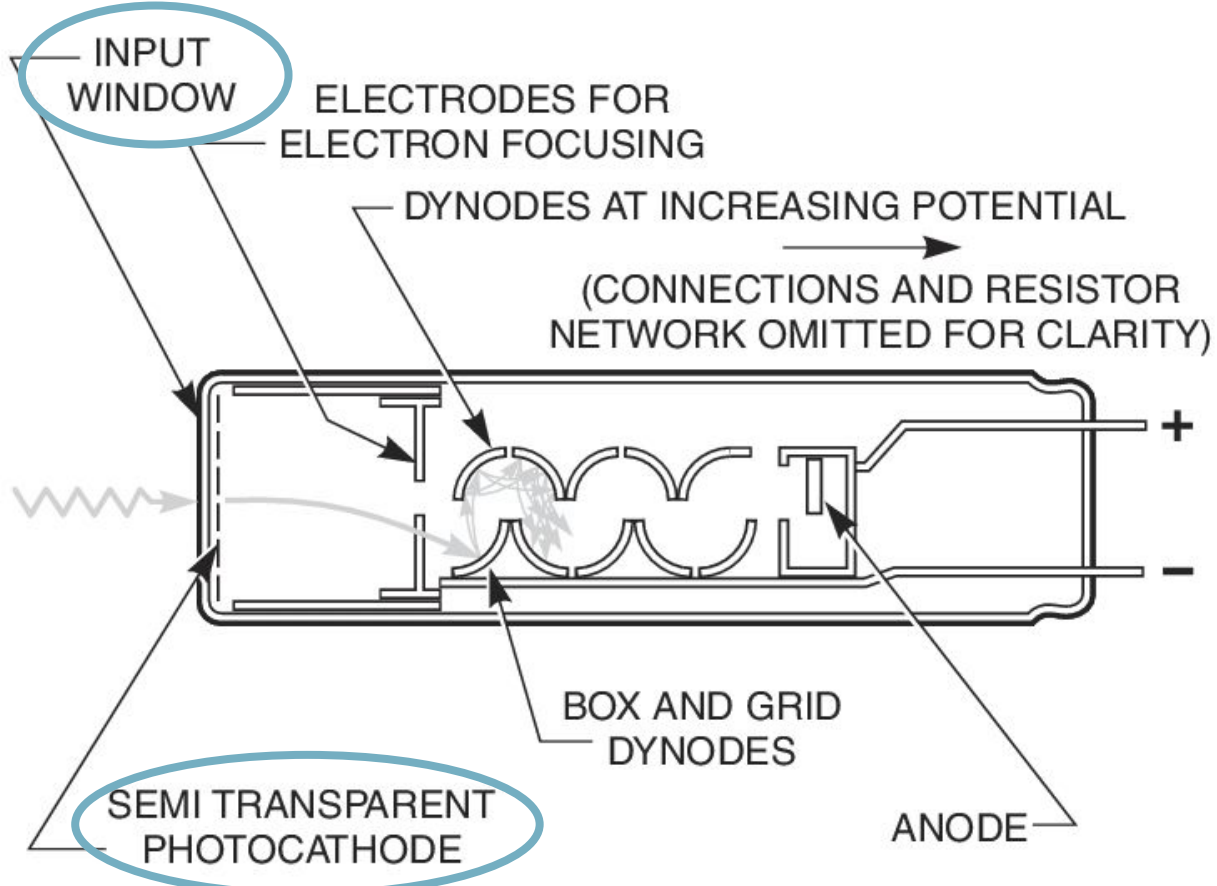

Photomultiplier Tubes

- Collection of (photo)electrons - Photo Detection Efficiency (PDE)

- Where the (photo)electrons go?
- How fast they go?
- Why do we want vacuum?

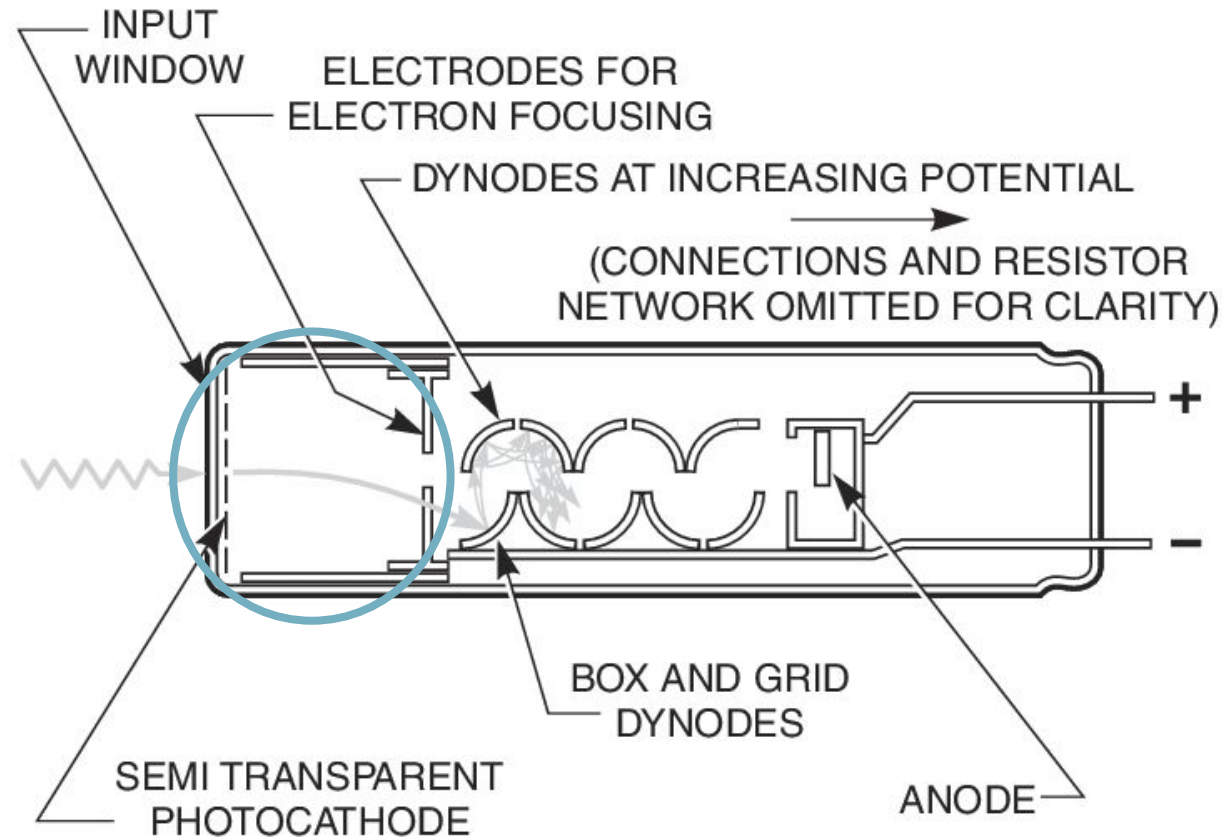

Photomultiplier Tubes

• Collection of (photo)electrons - PDE

- Where the (photo)electrons go?
- How fast they go?
- Why do we want vacuum?

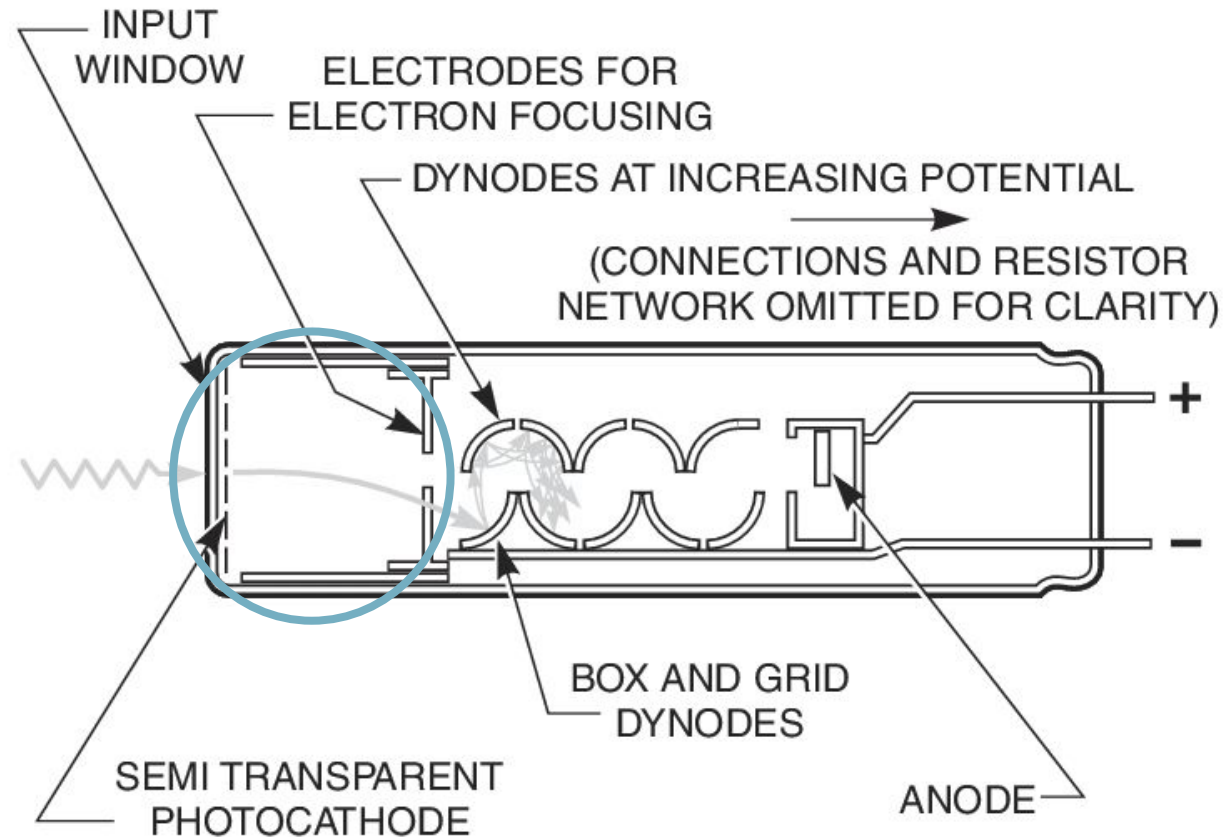

- Emitted electrons are quiet, hence they need to be collected by applying voltage (HV) between cathode and 1st dynode or focusing electrodes.
- Without vacuum, electrons would ionise particles and make the detection less clean. Not perfect vacuum and material from internal elements already produce undesired signals, the After pulses

Photomultiplier Tubes

- Multiplication to have sizeable signal

- Can we do something with 1 (photo)electron?
- How can be amplify the signal?
- Why do we have several stage amplification?

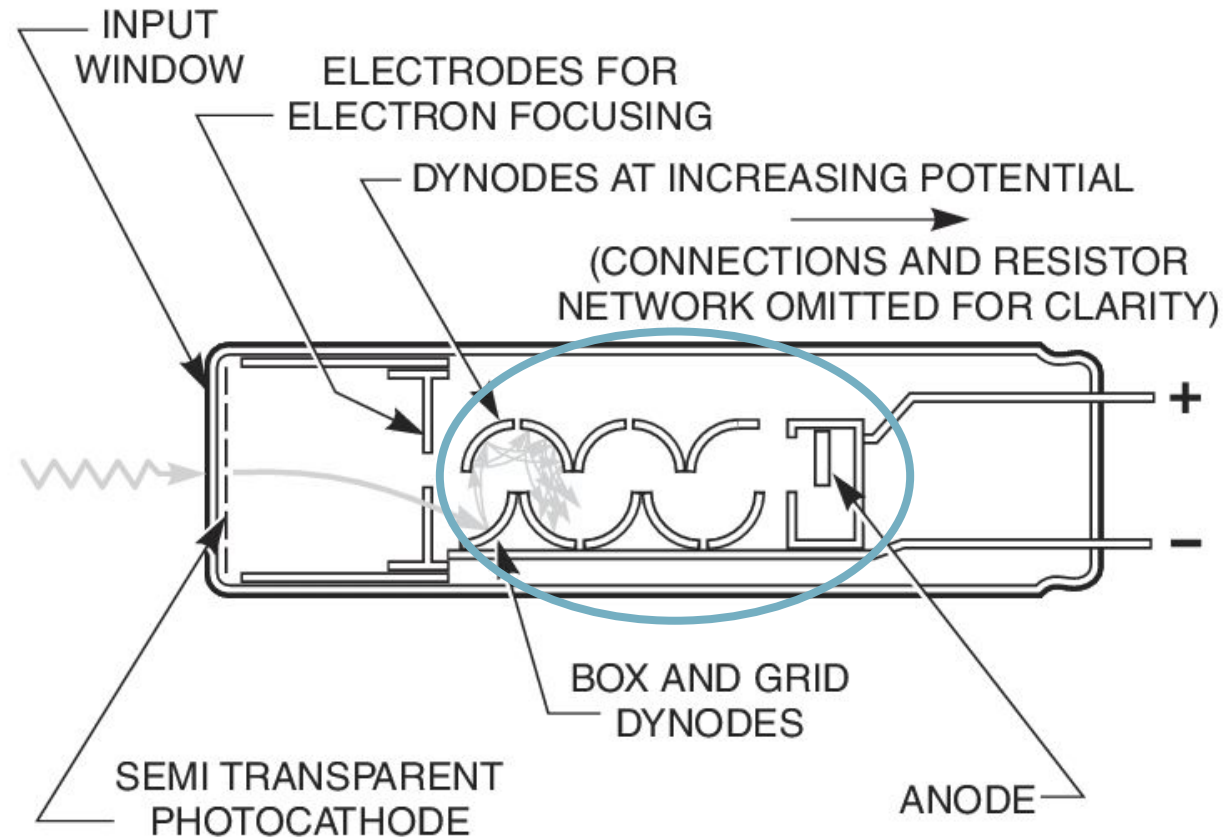

- The signal is amplified by making the electrons hitting the dynodes, which release several (~4-5) electrons for each hitting the dynode.
- It is an stochastic process, which induce (big) fluctuations on the number of electrons at anode for each (photo)electron.

Photomultiplier Tubes

- Characteristics

- Signal to noise ratio

- Clean, used to detect very low light levels
 - Still, dark current (thermal electrons) and after pulsing are unavoidable noise

- Time resolution and duty cycle

- Transit time: depending on HV and impact point, but at the level of few ns
 - Continuous measurement but (some) single photo(electron) capability

- Environment

- Sensitive to light, temperature and humidity
 - Sensitive to magnetic fields

Solid State Detectors

- Silicon Valley - (1971 - ????)
 - The name originally referred to Silicon chips being produced in the area
- Solid State detectors

Ionisation

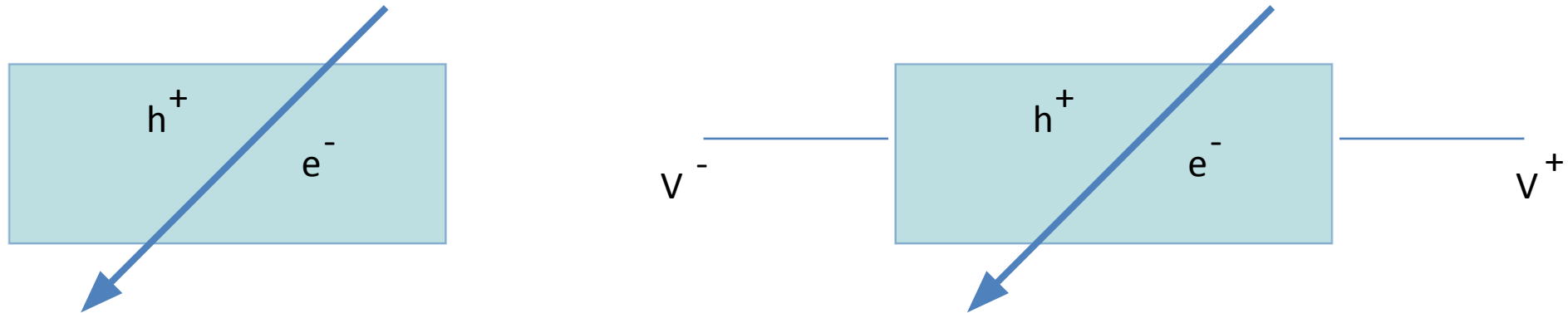

Semiconductors: Si (experience, cost, compactness), Ge, Ga-As

Solid State Detectors

• Semiconductors

- What is a semiconductor?
- Why do we need semiconductors?
- Do we have enough with a piece of semiconductor (Si)?

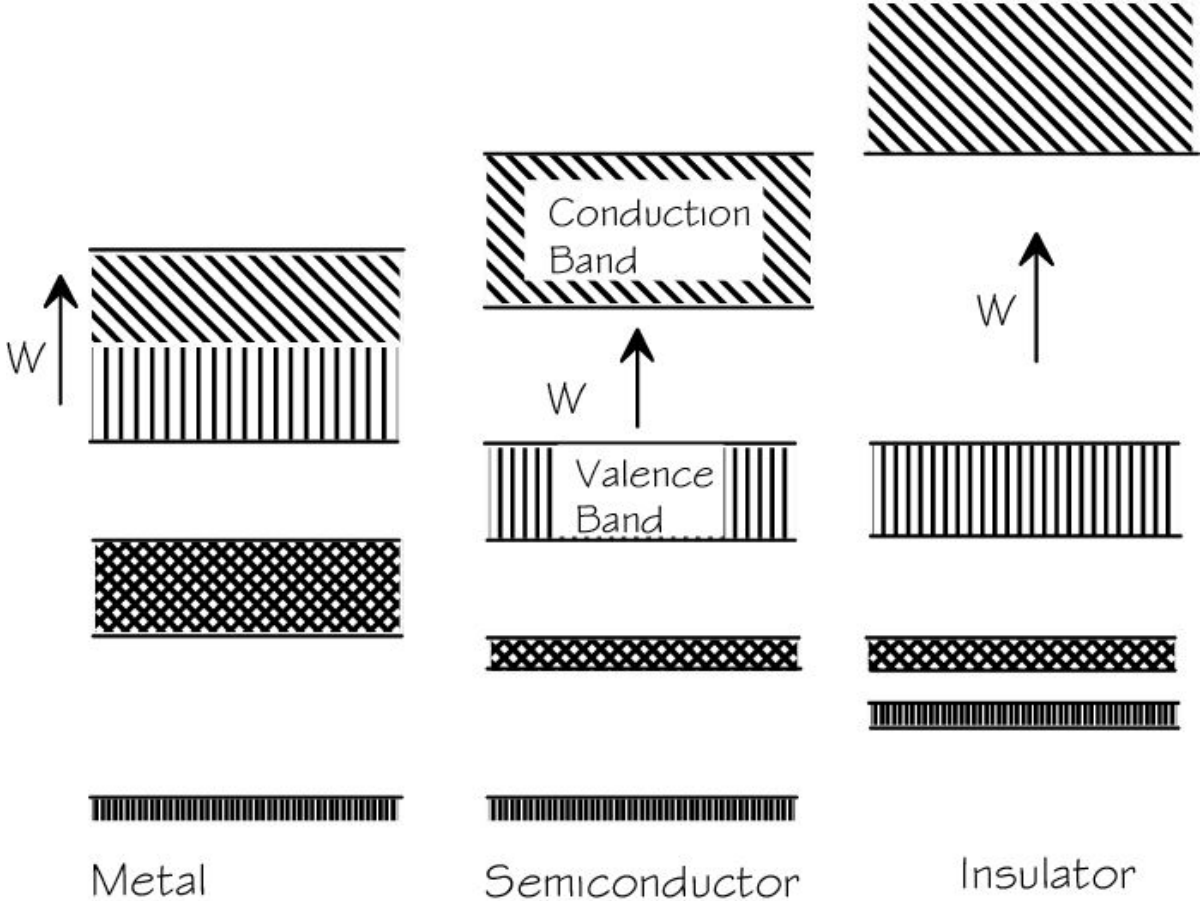

- In semiconductors the light, or other particles, bring electrons to the conduction band
- One ionisation makes one electron in the conduction band, which means no amplification
- Thermal noise can also bring electrons to the conduction band

Solid State Detectors

- PN junction
 - Doping semiconductors

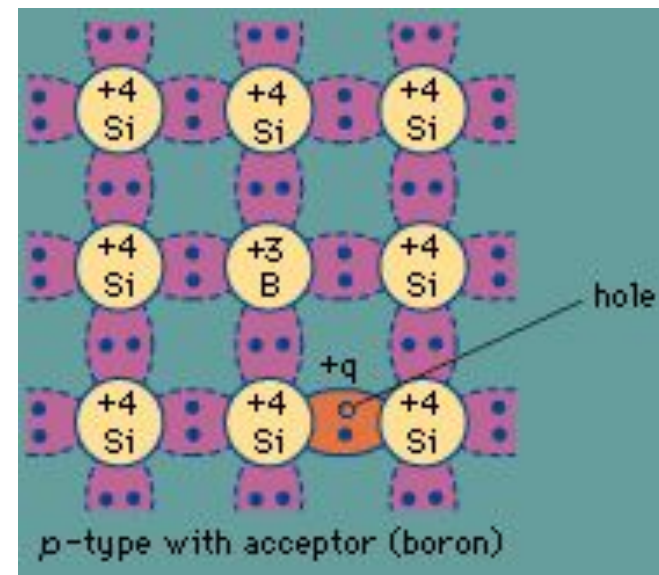
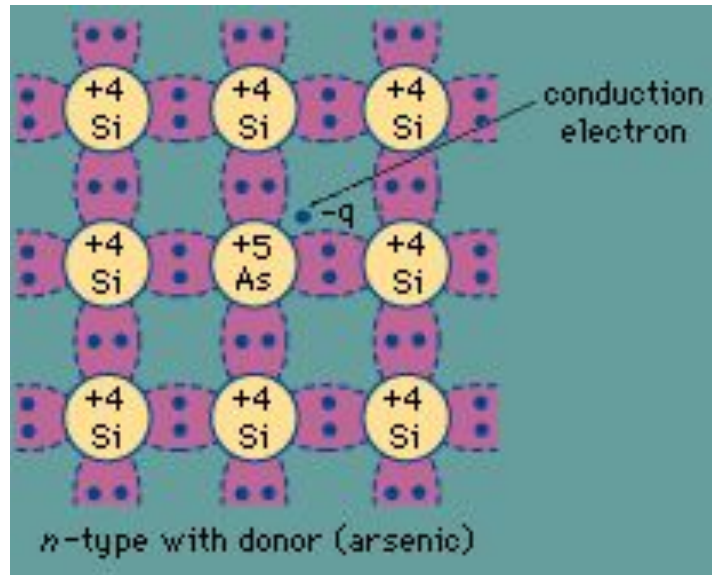

Increase the density of the carriers (conduction electron or hole)

Solid State Detectors

- PN junction
 - Depletion zone

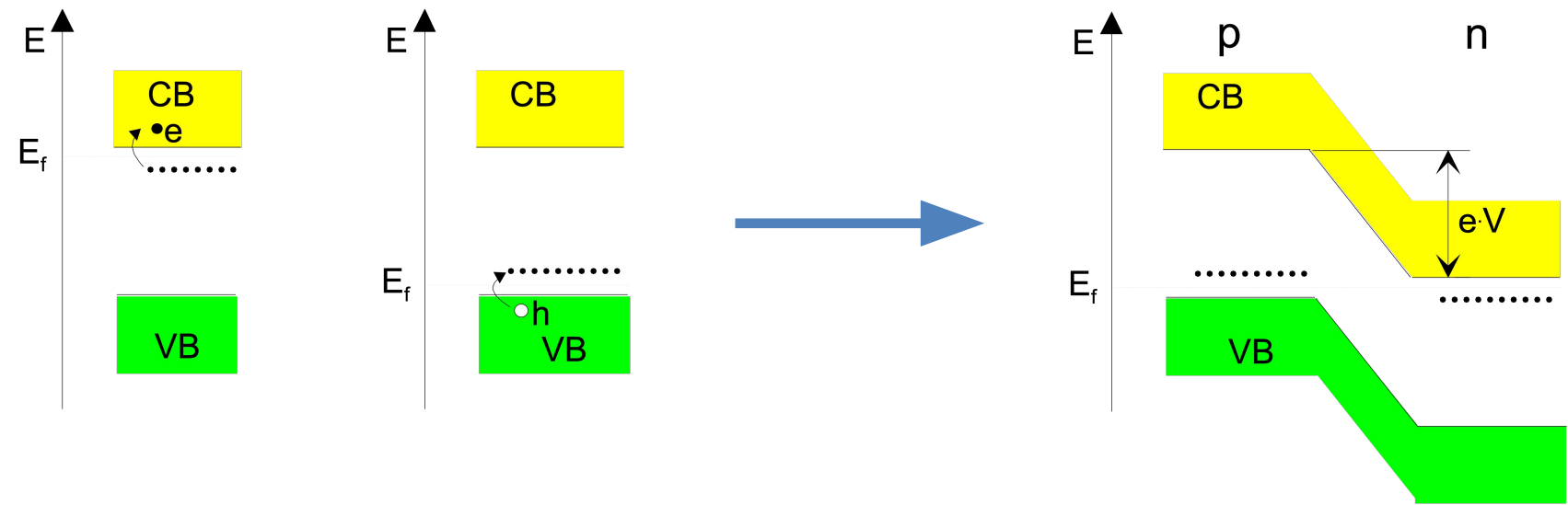

Region without carriers that will be very sensitive to induced charges

CMOS

- CMOS: Combination of p-type and n-type
 - PN Junction: Direct polarisation

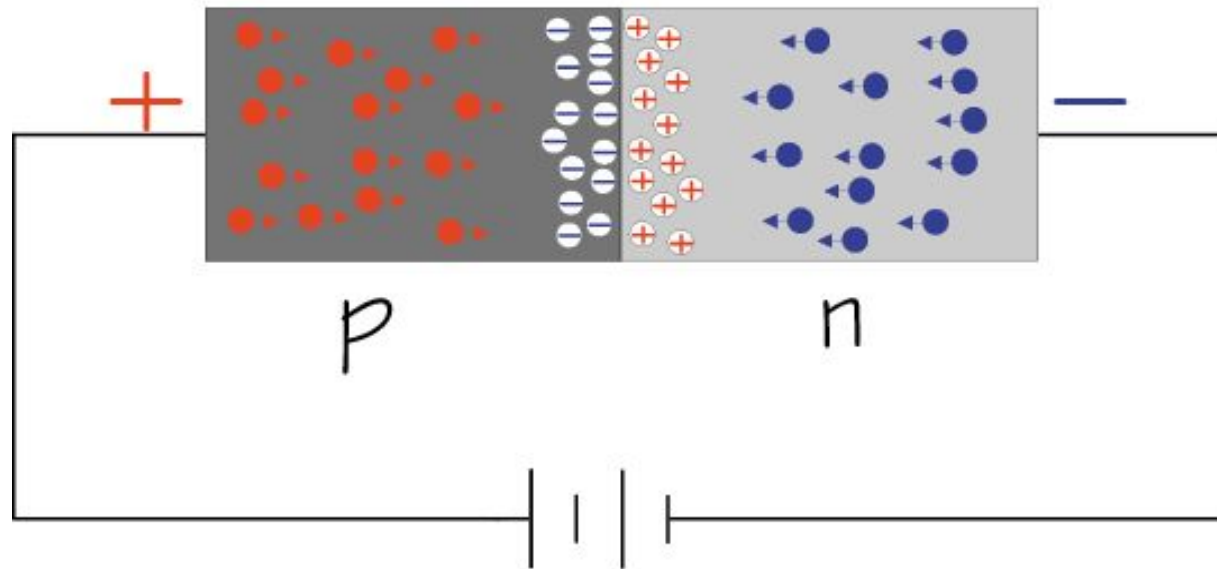

If applied voltage is enough to overpass the PN Junction barrier (diode)

CMOS

- CMOS: Combination of p-type and n-type
 - PN Junction: Inverse polarisation

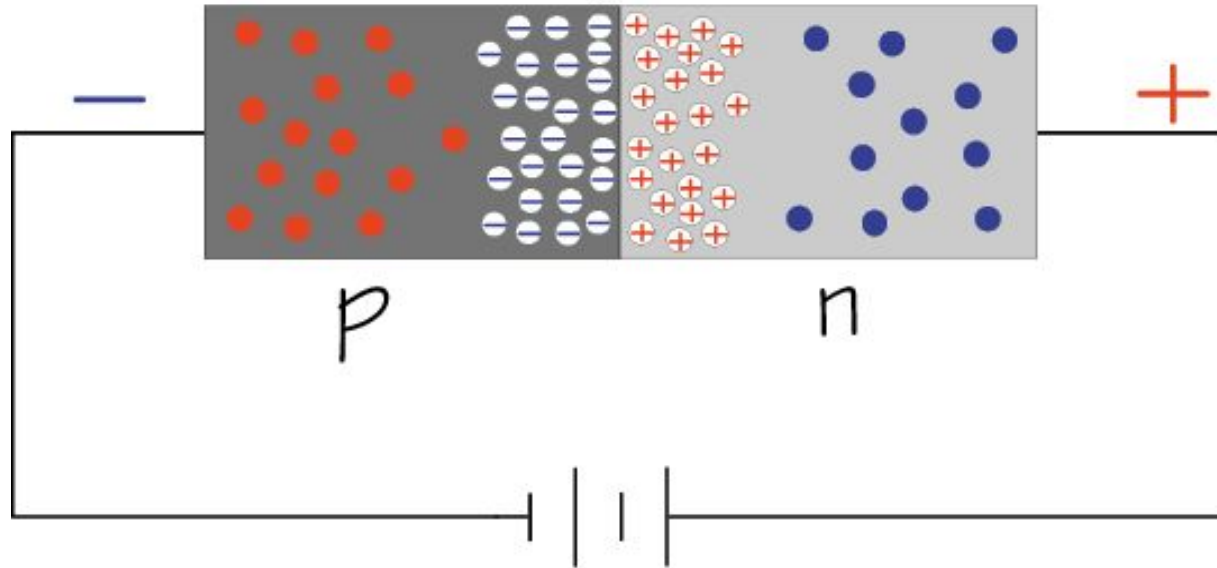

Large depletion region, gain can go to a factor 1000

CMOS

- Detectors based on PN junctions

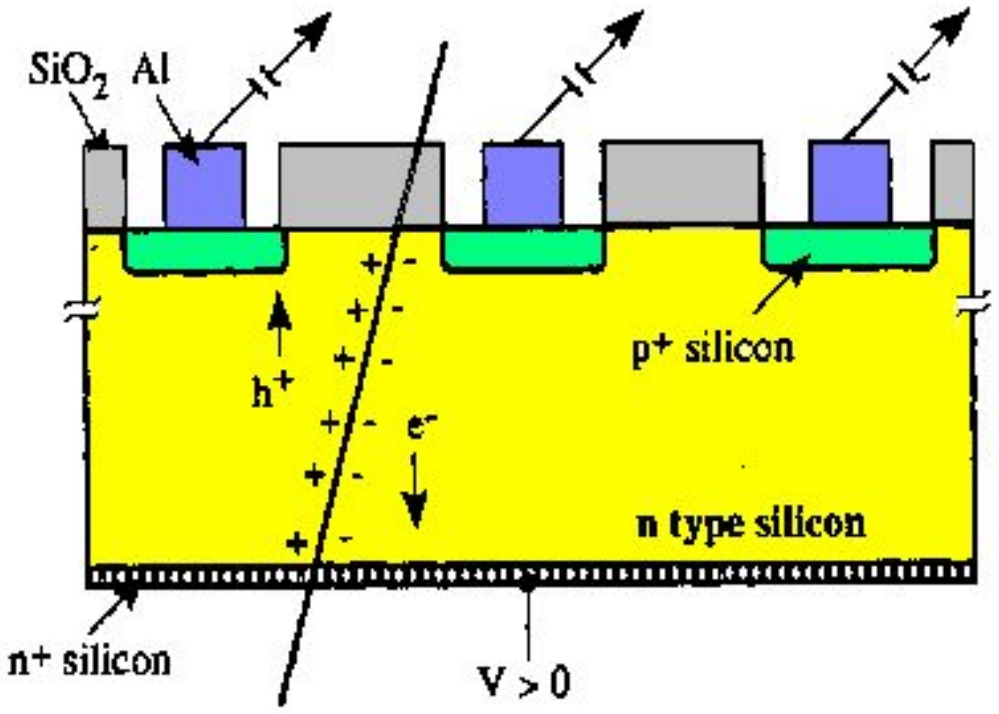

MicroStrips

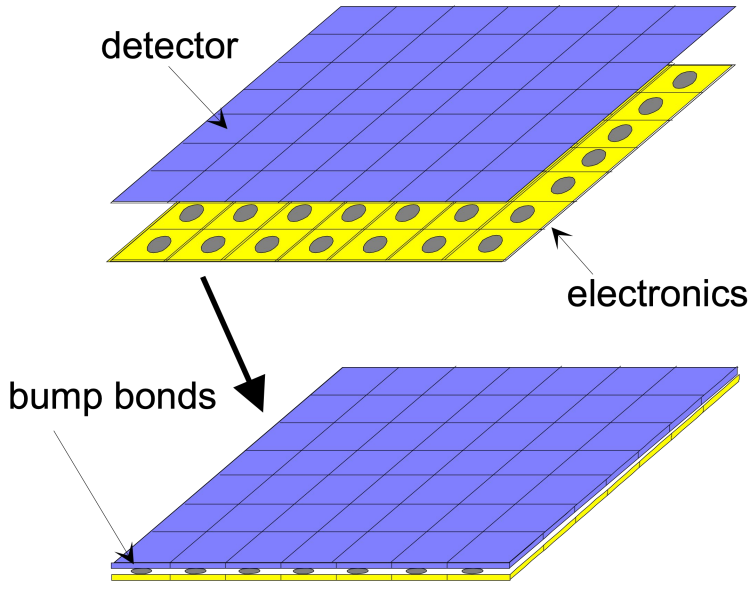

Silicon Pixel Detector

CMOS

- CMOS: Combination of p-type and n-type
 - PN Junction: Inverse polarisation

- Depletion region depends on the voltage applied, but there is a maximum size for the depletion region.

- What happens if we keep increasing the voltage?

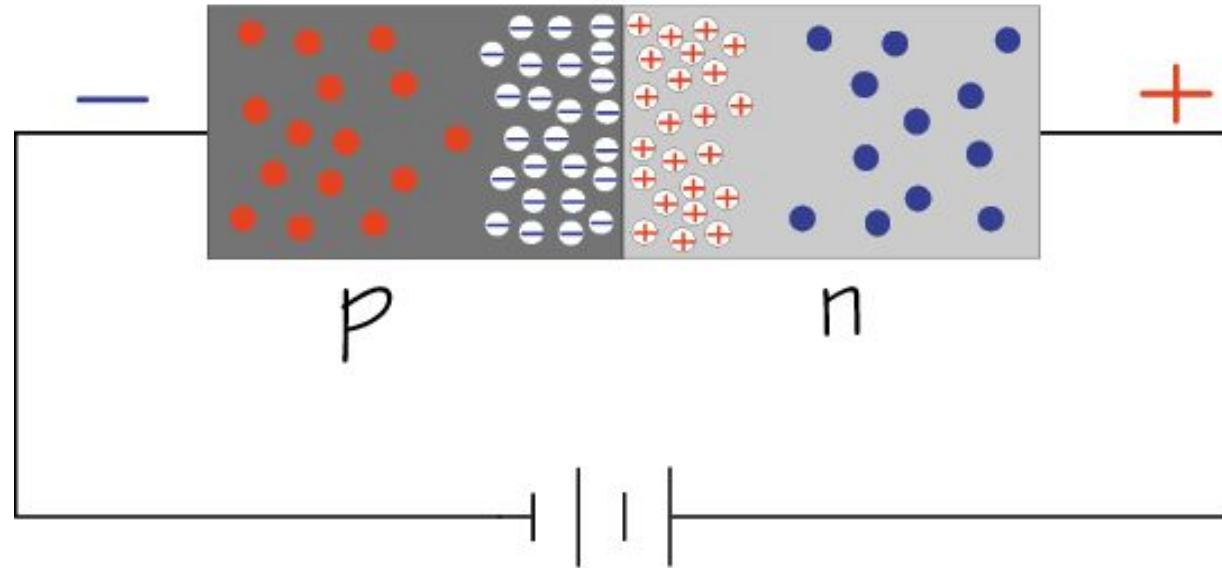

- Zener effect
- Avalanche/Geiger mode
- Can they be useful?

CMOS

- **Avalanche Photo Diode (APD)**

- PN Junction in Geiger mode
- Two PN junctions:
 - Region 1: Light conversion
 - Region 2: Amplification - 1 000 000
- Single ionisation leads to maximum signal
- Slow recovering
- Temperature and Voltage dependence

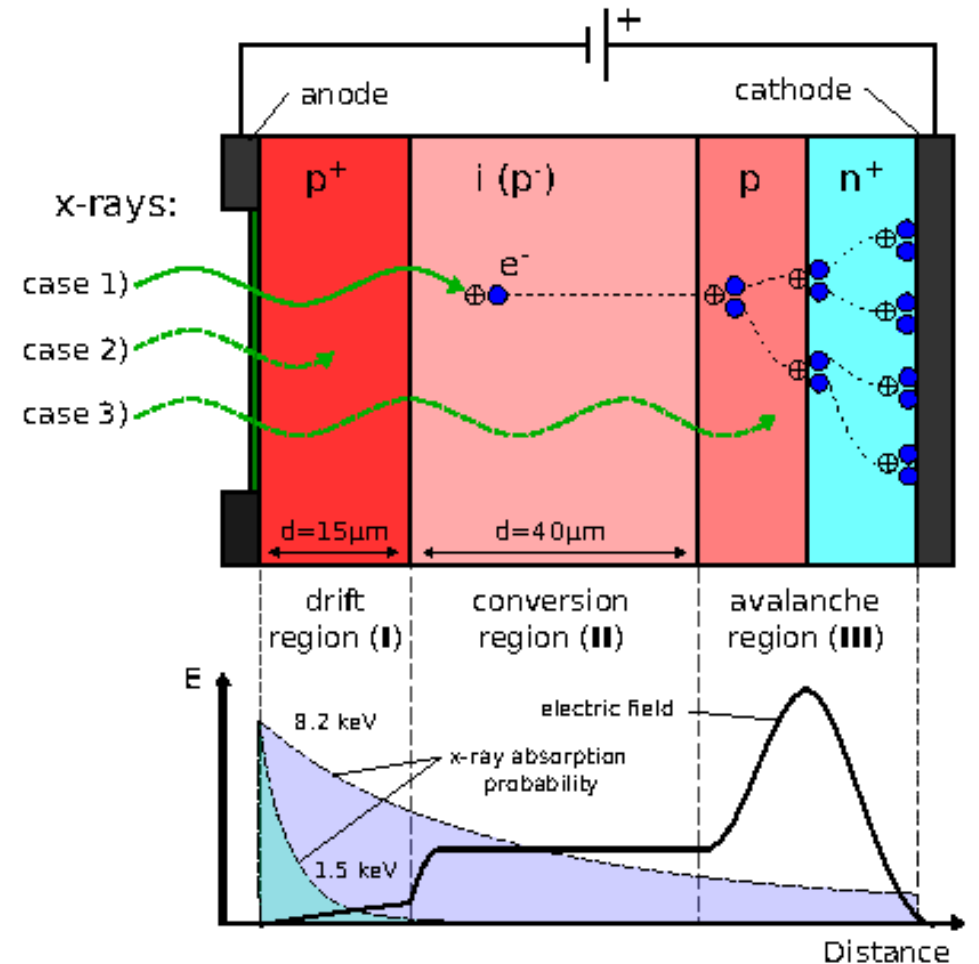

SiPM

- Array of APD

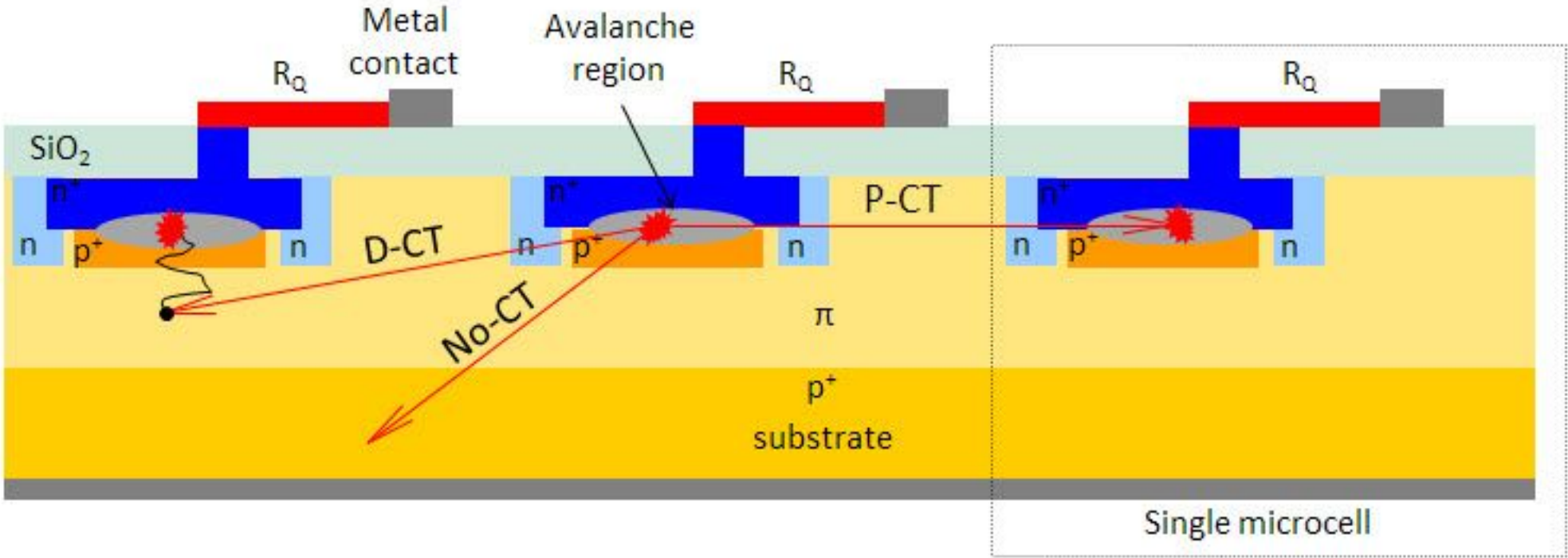

SiPM

- Array of APD

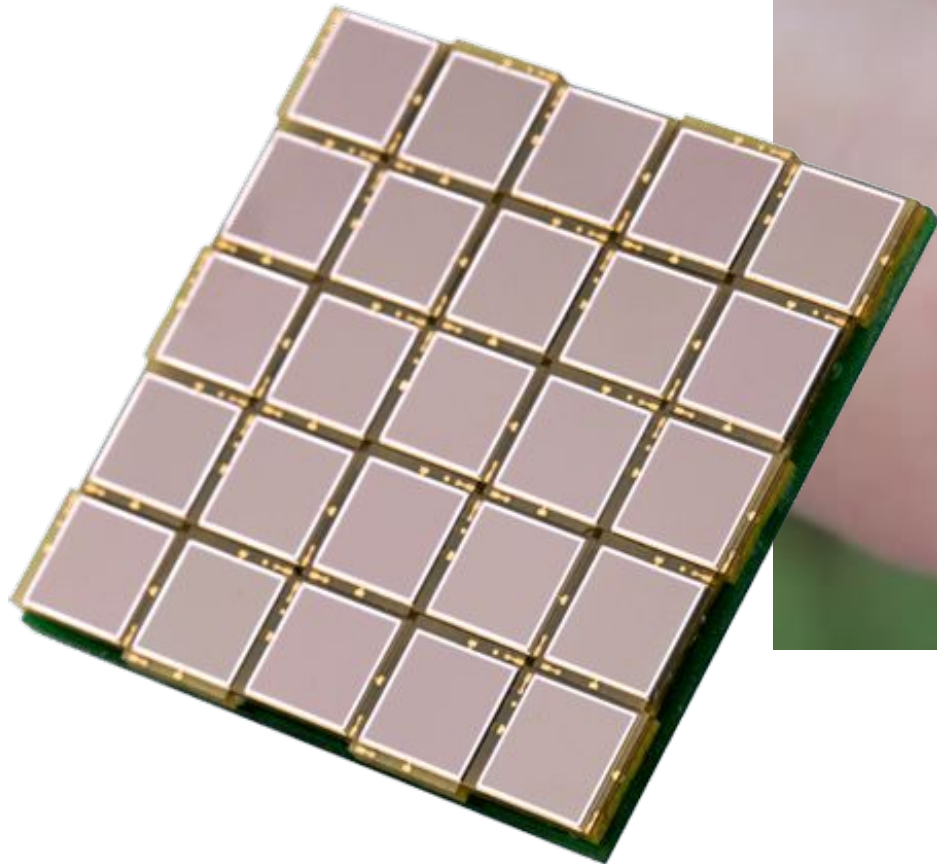

Microcell ~ 3-30 μm ; 1000-10 000 microcells

SiPM

- The “historical” large QE

- Wavelength range depends on Material, but APD reach >80%
- Can we get that with SiPM?
- Is the wavelength dependence a problem?

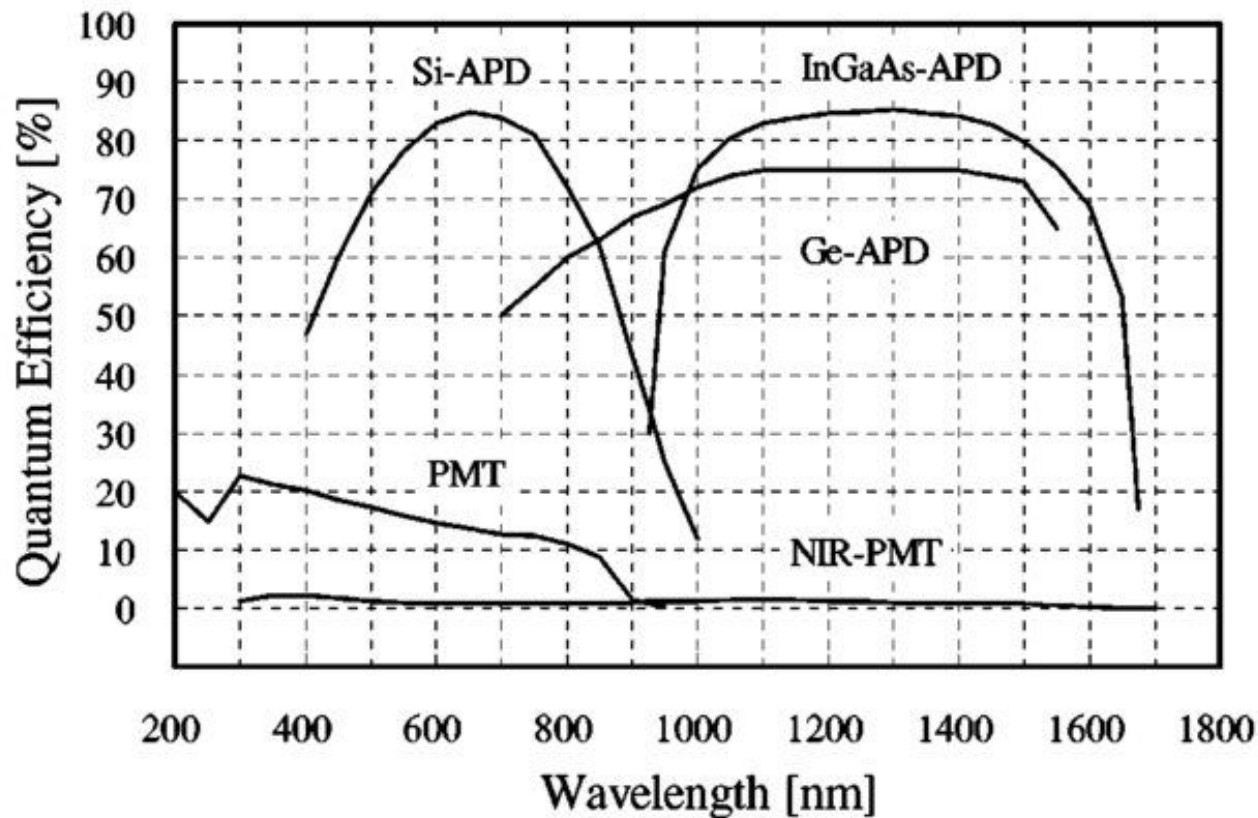

- SiPM are arrays of APD, but not 100% sensitive surface (~50%), fill factor
- PDE should include probability to initiate Geiger discharge, ~60%
- Still, PDE well above 50% was reported initially !?!

SiPM

- The “historical” large QE

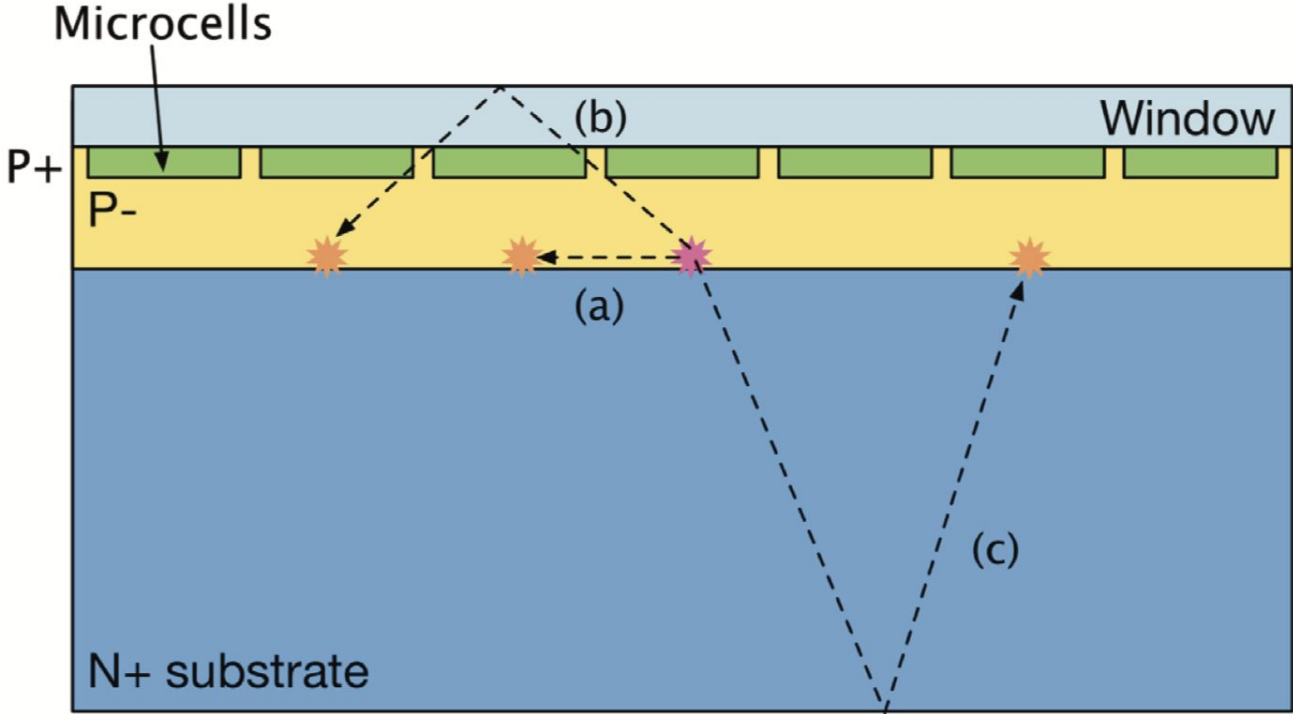

Crosstalk, PDE measured by sending $N (>1)$ is overestimated

SiPM

- The “historical” large QE

Fine tuning of design allows to reduce crosstalk, but it usually also reduces PDE

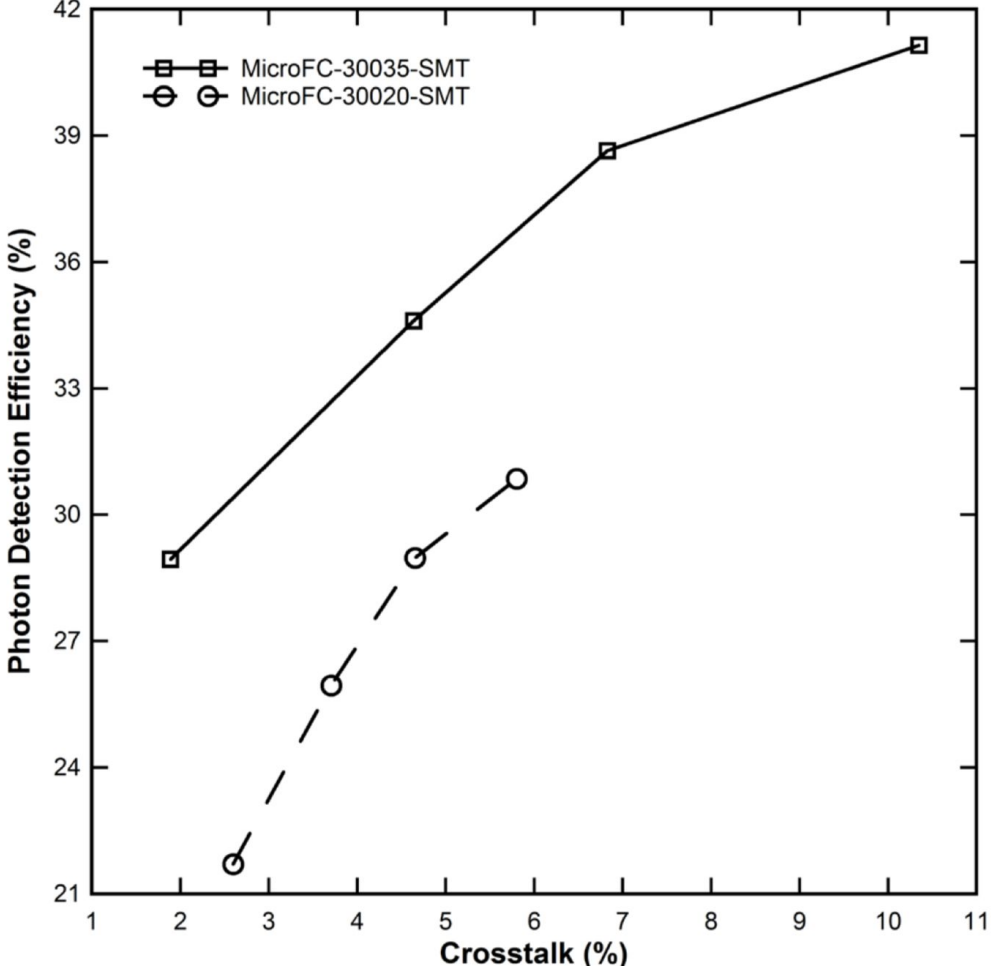

SiPM

- Wavelength range

- Wavelength range depends on Material, but APD reach >80%

- Can we get that with SiPM?

- Is the wavelength dependence a problem?

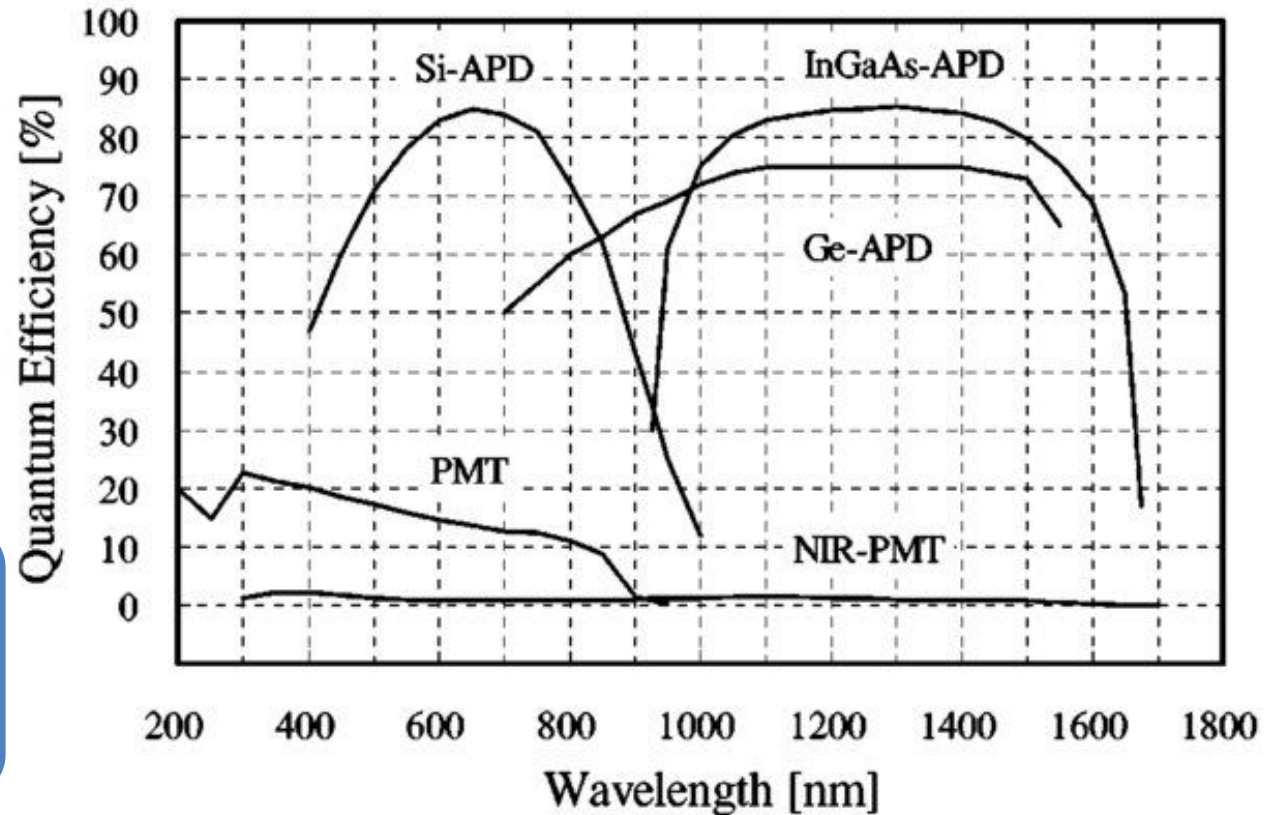

SiPM

- Wavelength range

- Wavelength range depends on Material, but APD reach >80%

- Can we get that with SiPM?

- Is the wavelength dependence a problem?

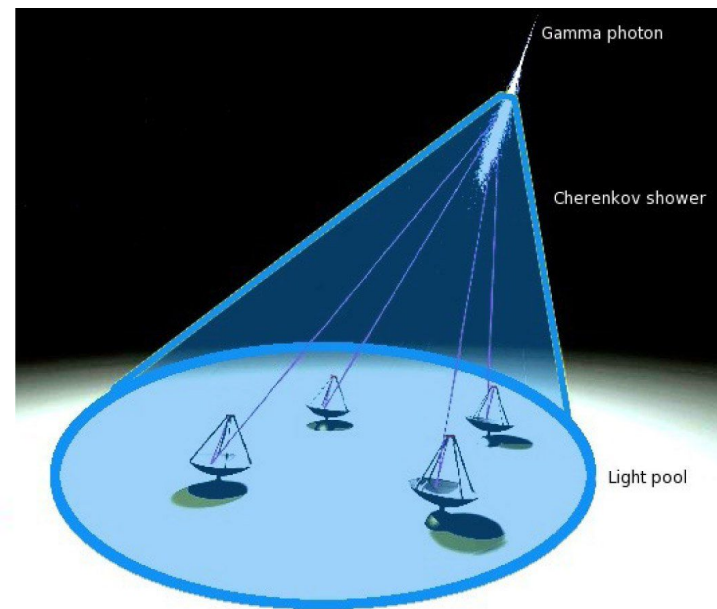
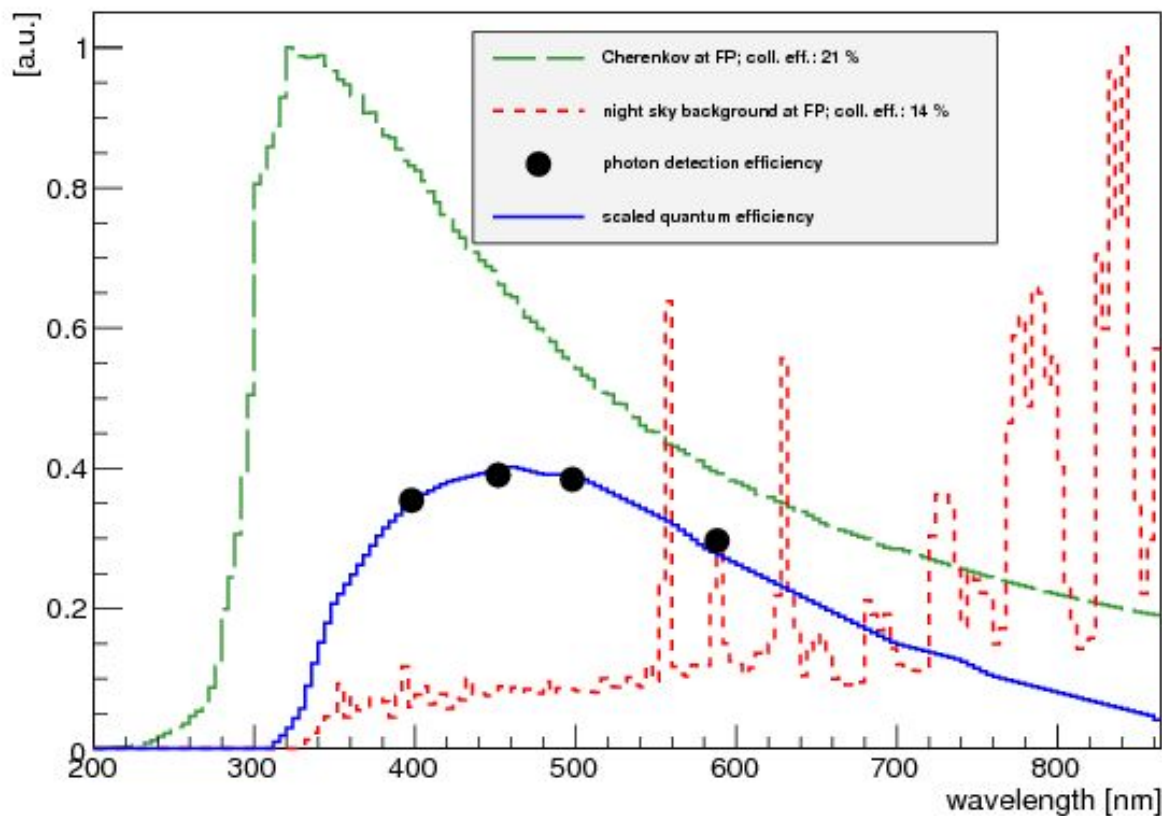

It depends on the application!

SiPM

• Timing

- Geiger discharge provides the rise time.
- Discharge of the provided carriers provides fall time.
- Dead time of APD and SiPM.

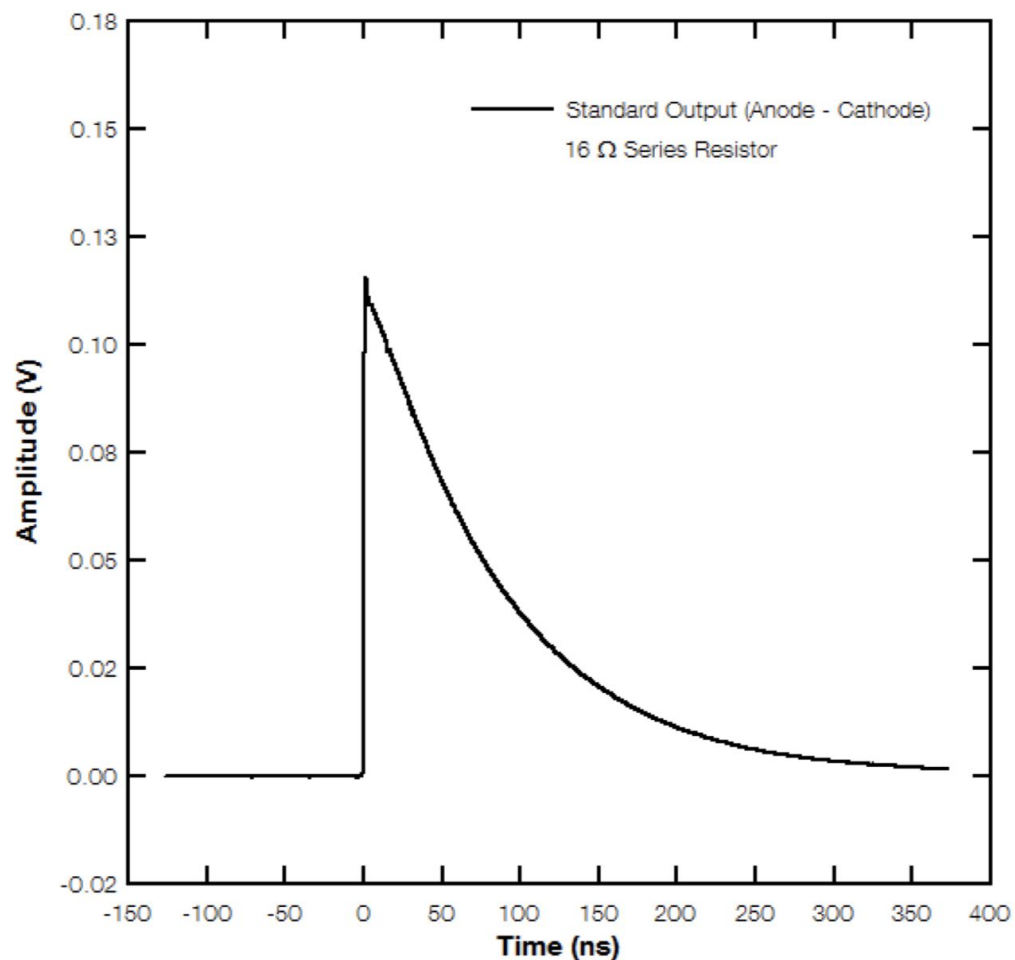

- Geiger discharge 500 ps; Recovery 100-500 ns.
- Recovery time is basically the dead time of micro-cell (APD) but many in a SiPM.
- Very good for fast response of no continuous signal
- Recovery can be improved, which is needed for continuous signals, quenching resistor

SiPM

- Photoelectrons counter

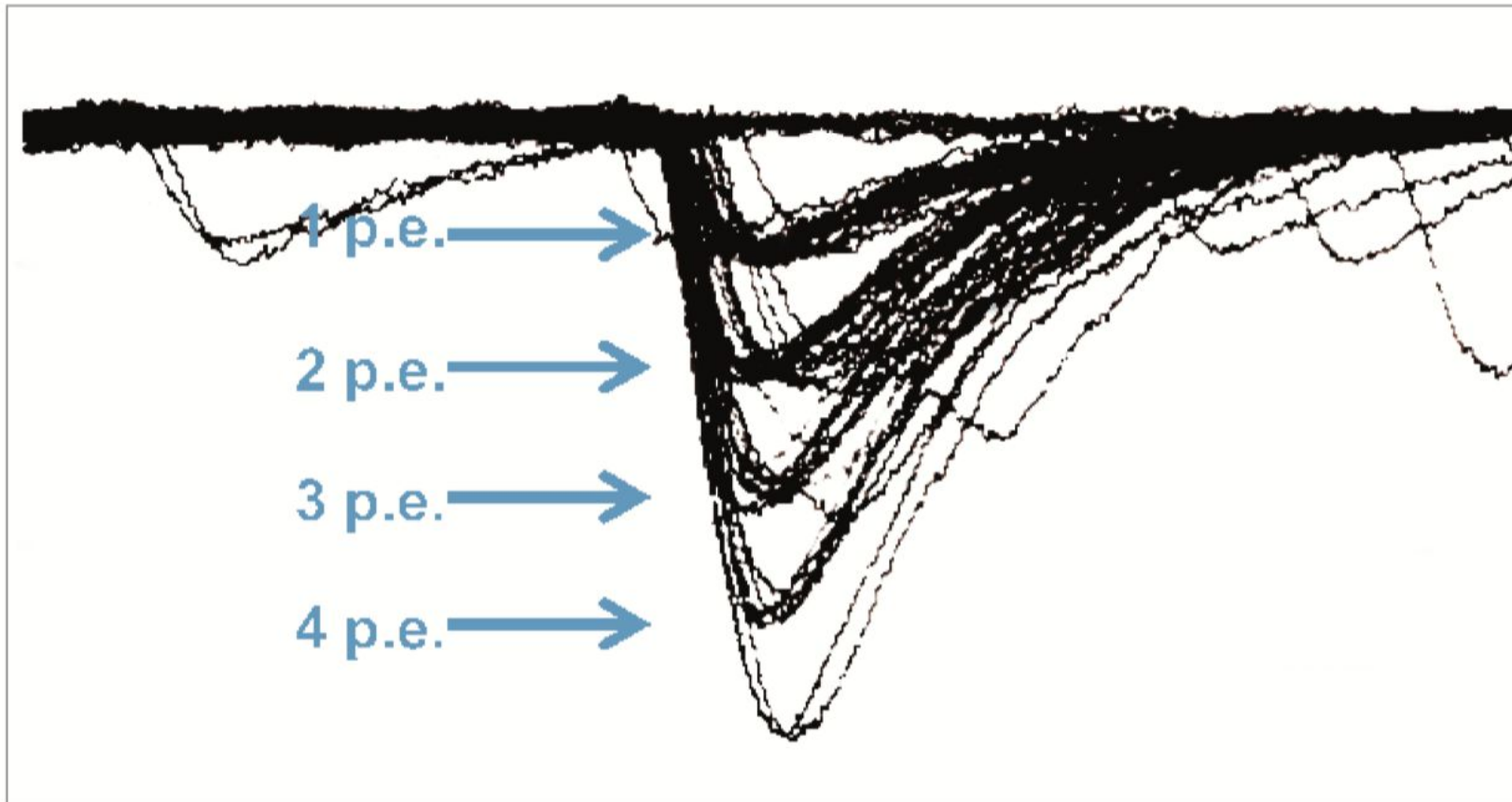

SiPM

- Photoelectrons counter

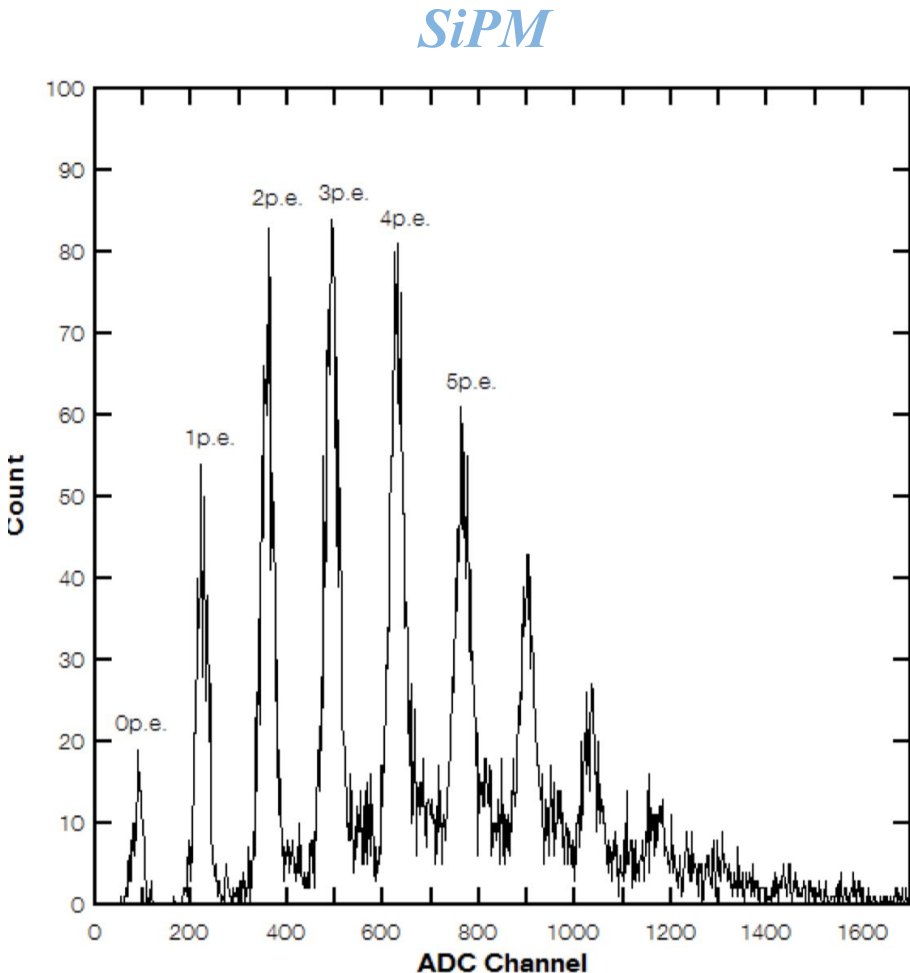
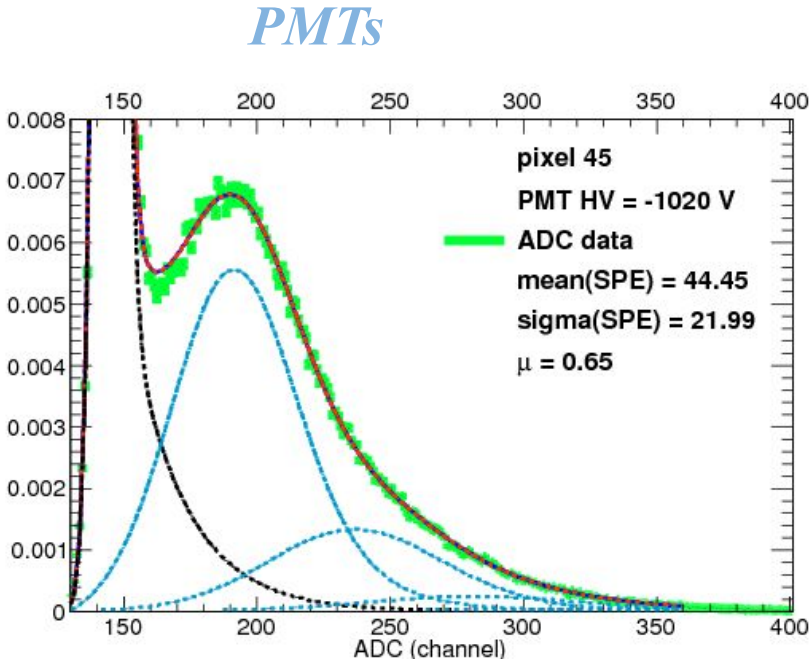

CCD

- Charge Coupled Devices (CCDs)
- Array of MOS capacitors

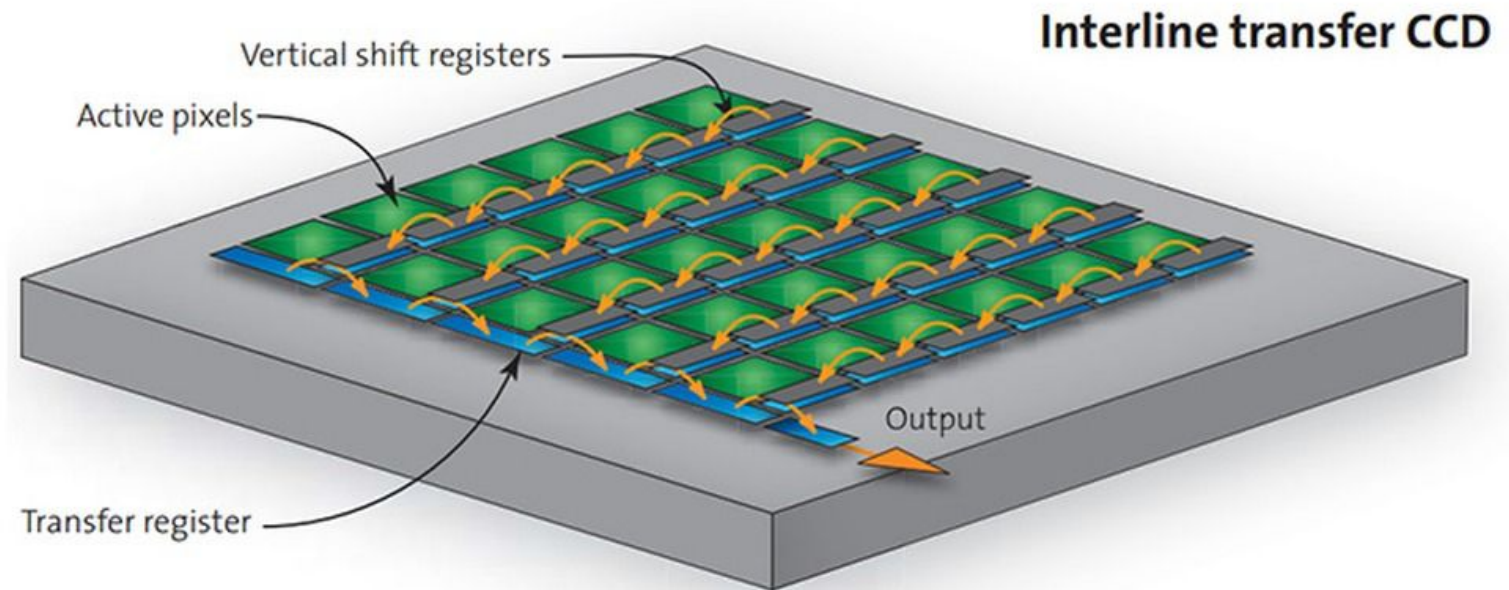
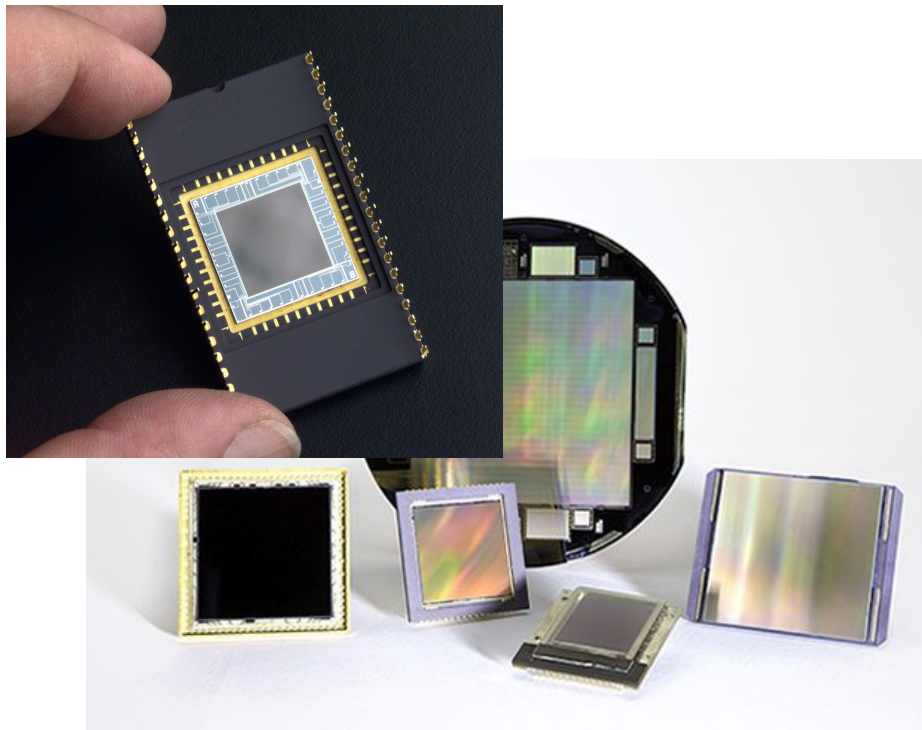

CCD

- Charge Coupled Devices (CCDs)
 - Array of MOS capacitors

- Each capacitor accumulated charge proportional to the light reaching that location
- This charge needs to be read

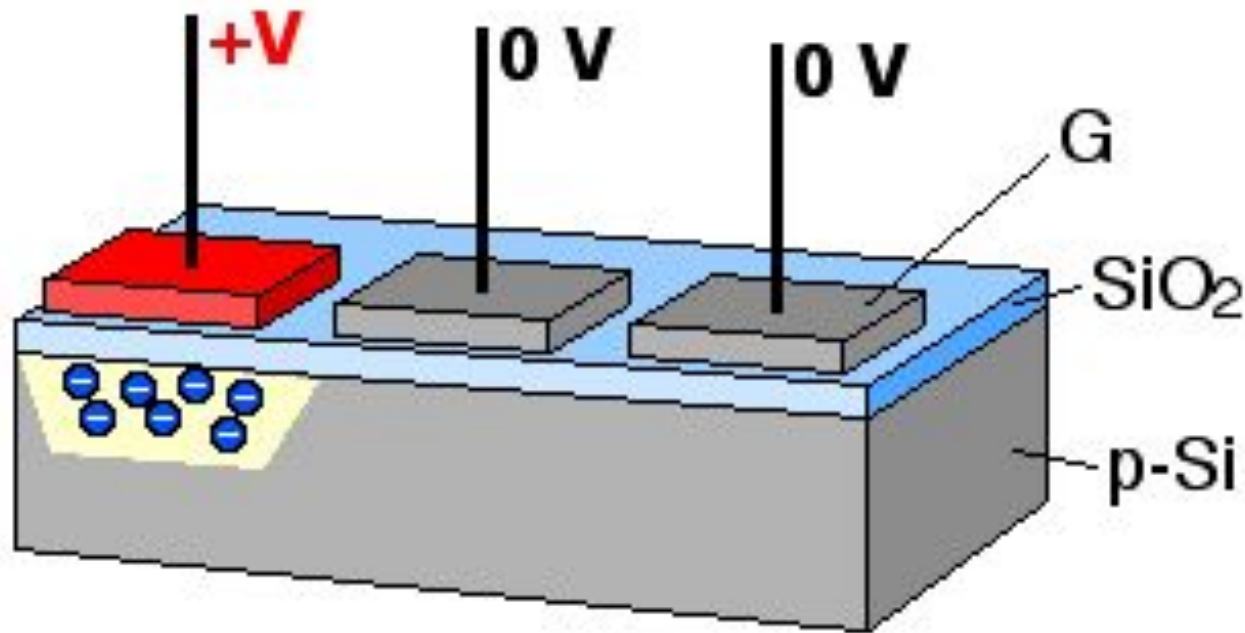

- Very good for integrated signals

CCD

- Front vs back illuminated

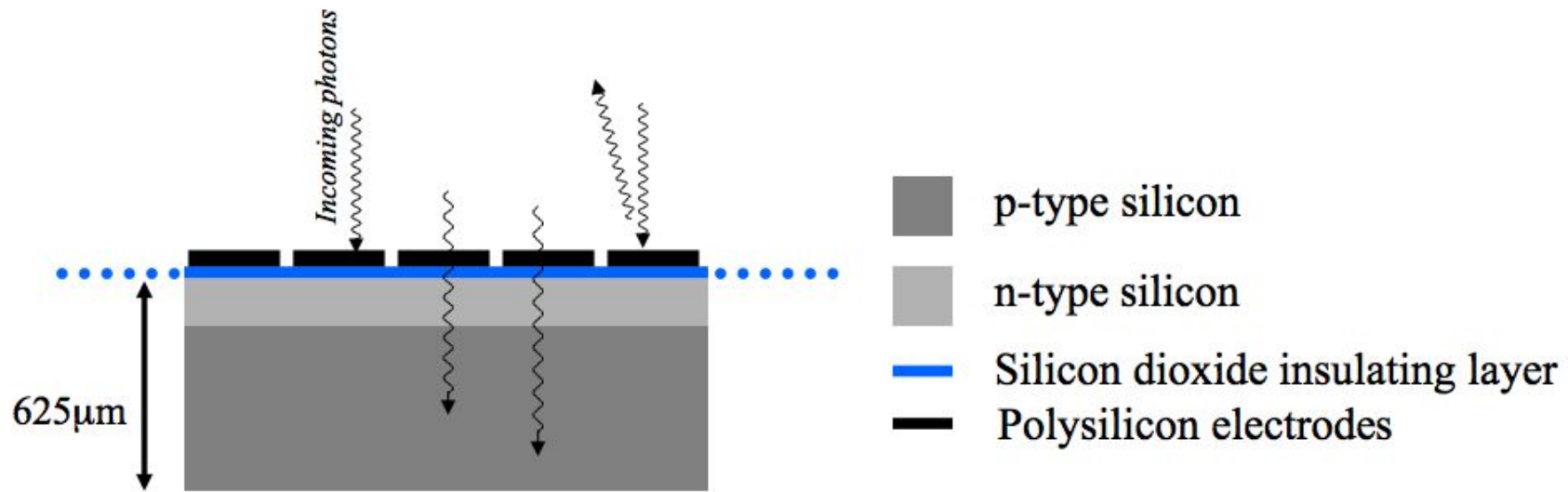

CCD

- Front vs back illuminated

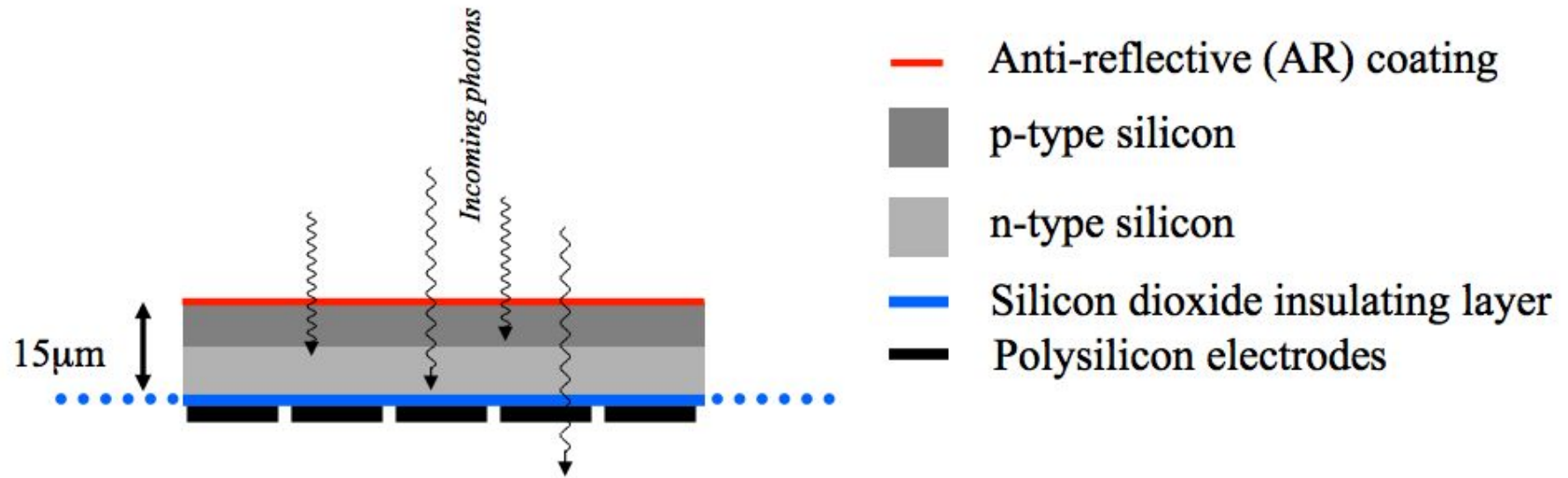

CCD

- Front vs back illuminated

- Back-thinned CCD have larger QE thanks to reduced absorption (electrodes and p-type layer)
- Still, they may have problem at large wavelength (red photons need more absorption length)
- They are fragile

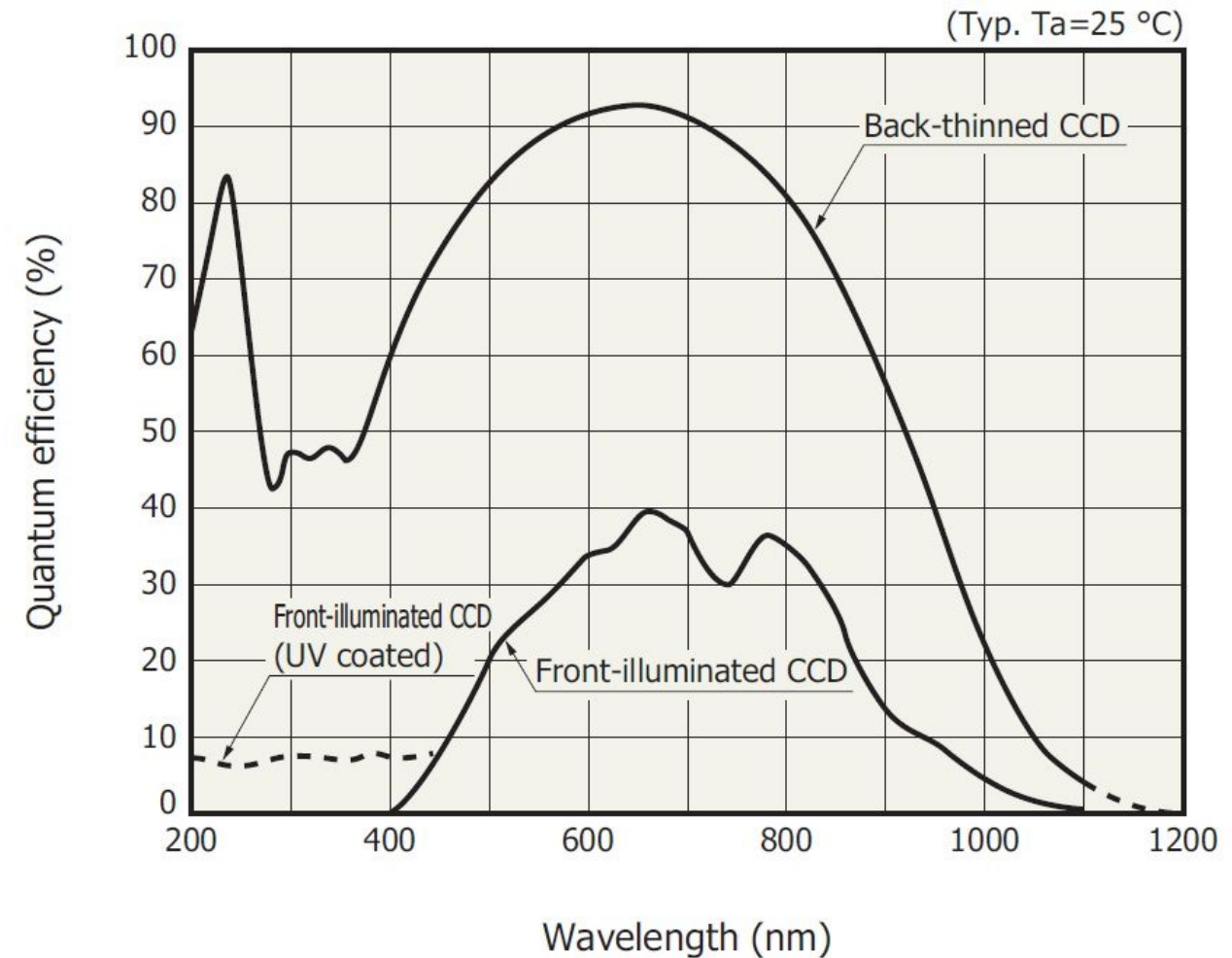

9. Auxiliary Systems

- Outline
 - Power System
 - Calibration Systems
 - Atmospheric Monitoring
 - Safety Systems

Disclaimer: The following slides do not go into detail but were included since they can heavily influence the telescope design.

Power System

- Stability of mains power: Observatories usually in remote places with harsh environmental conditions, so frequent power cuts can be expected.
- Uninterruptable Power Supply (UPS): Fast replacement power to avoid shutdown of vital systems (control systems, safety systems, etc.), basically a large battery that is always charged.
- Backup/Emergency power: UPS is fast but does not last long, alternative power is needed, typically in the form of a Diesel generator. Consider also a portable unit for emergencies.
- Additional power: May be necessary to compensate high loads for power intensive actions (e.g., fast movements with high inertia). Can be provided by fly wheels (rotating mass in a vacuum) or similar.
- Using renewable power systems is desirable but comes with additional costs and complexity.

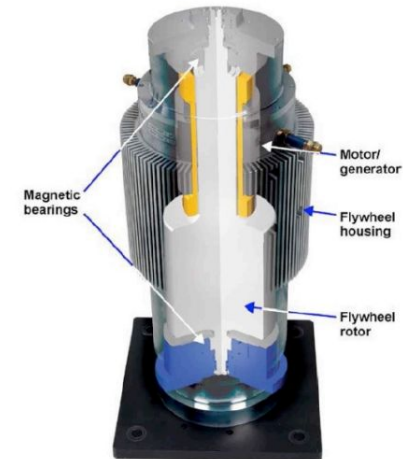

Calibration Systems

- Camera Calibration: Depending on the camera sensors an external calibration laser may be needed to calibrate the response of the sensors.
- Structure Calibration: Typically a Bending Model is needed to align the drive control and the pointing direction depending on the observational direction of the telescope. Depending on mount type and stiffness this can be very complicated. Hysteresis effects and oscillations may have to be considered.
- Pointing: Uncertainties or unpredictable disturbances (e.g., due to wind) affecting the pointing can be corrected by distance meters, laser guidance, or cameras to observe deformations or deviations in position (StarGuider).
- Optical Quality: The size of the Point Spread Function (PSF) needs to be monitored, typically by a dedicated camera and observations of stars. The mirror reflectivity is another important parameter to keep track of.

Atmospheric Monitoring

- Knowledge of basic conditions and trends is important for the telescope site. This characterization takes years and is done with many instruments (weather stations, weather balloons, numerical weather models, and many more).
- During the operations, several parameters are monitored to characterize the atmosphere (i.e., the detector volume):
 - Current Weather: Basic weather stations are important for safety (avoid damaging equipment) and data quality (avoid taking useless or corrupted data).
 - Molecular Scattering: Typically very predictable with models, does not vary a lot.
 - Aerosol Scattering: Can be very variable, profiles can be measured by LIDAR systems. Dust counters can be used to measure the concentration on the ground.
 - Cloud Detection: Also done with LIDAR systems or specialized ceilometers.
 - Sun photometers and other photometric systems can measure integral transmission.

Safety Systems

- Risk Assessment / Hazard Analysis: Like every “machine”, a telescope must be safe for humans and the environment. Safety systems are necessary to mitigate the hazards associated with constructing, installing, and operating a telescope:
 - Fences: Not only to control unauthorized access but also to make authorized access safer.
 - Interlocks: System of sensors and Programmable Logic Controllers (PLCs) to inhibit dangerous motions. Must be robust and fail safe.
 - Procedures: Who is allowed to do what and when, what material do they need and how are they performing their tasks. Manuals and procedures need to be clear.
 - PPE: If technical or procedural measures are not enough, personnel needs to have the right safety equipment (helmet, harness, gloves, sun protection).
 - Cyber Security: To avoid unauthorized access to telescope systems, avoid data loss or corruption, avoid ransomware attacks or similar.