



Monte Carlo simulations - Allpix²

Daniel Hynds

Updated simulation configuration

```
[Allpix]
number_of_events = 1000
detectors_file = "tutorial-geometry.conf"
log_level = "Warning"
```

```
[GeometryBuilderGeant4]
```

```
[DepositionGeant4]
particle_type = "Pi+"
source_energy = 120GeV
source_type = "beam"
beam_size = 3mm
source_position = 0um 0um -200mm
beam_direction = 0 0 1
physics_list = FTFP_BERT_EMZ
```

```
[ElectricFieldReader]
model="linear"
bias_voltage=-50V
depletion_voltage=-30V
output_plots = 1
```

```
[ProjectionPropagation]
temperature = 293K
output_plots = 1
```

```
[SimpleTransfer]
output_plots = 1
```

```
[DefaultDigitizer]
threshold = 600e
output_plots = 1
```

```
[detector1]
type = "timepix"
position = 0mm 0mm 0mm
orientation = 0 0 0
```

```
[detector2]
type = "timepix"
position = 0mm 0mm 20mm
orientation = 0 0 0
```

```
[detector3]
type = "timepix"
position = 0mm 0mm 40mm
orientation = 0 0 0
```

```
[detector4]
type = "timepix"
position = 0mm 0mm 60mm
orientation = 0 0 0
```

```
[detector5]
type = "timepix"
position = 0mm 0mm 80mm
orientation = 0 0 0
```

```
[detector6]
type = "timepix"
position = 0mm 0mm 100mm
orientation = 0 0 0
```

Visualising the setup

[VisualizationGeant4]

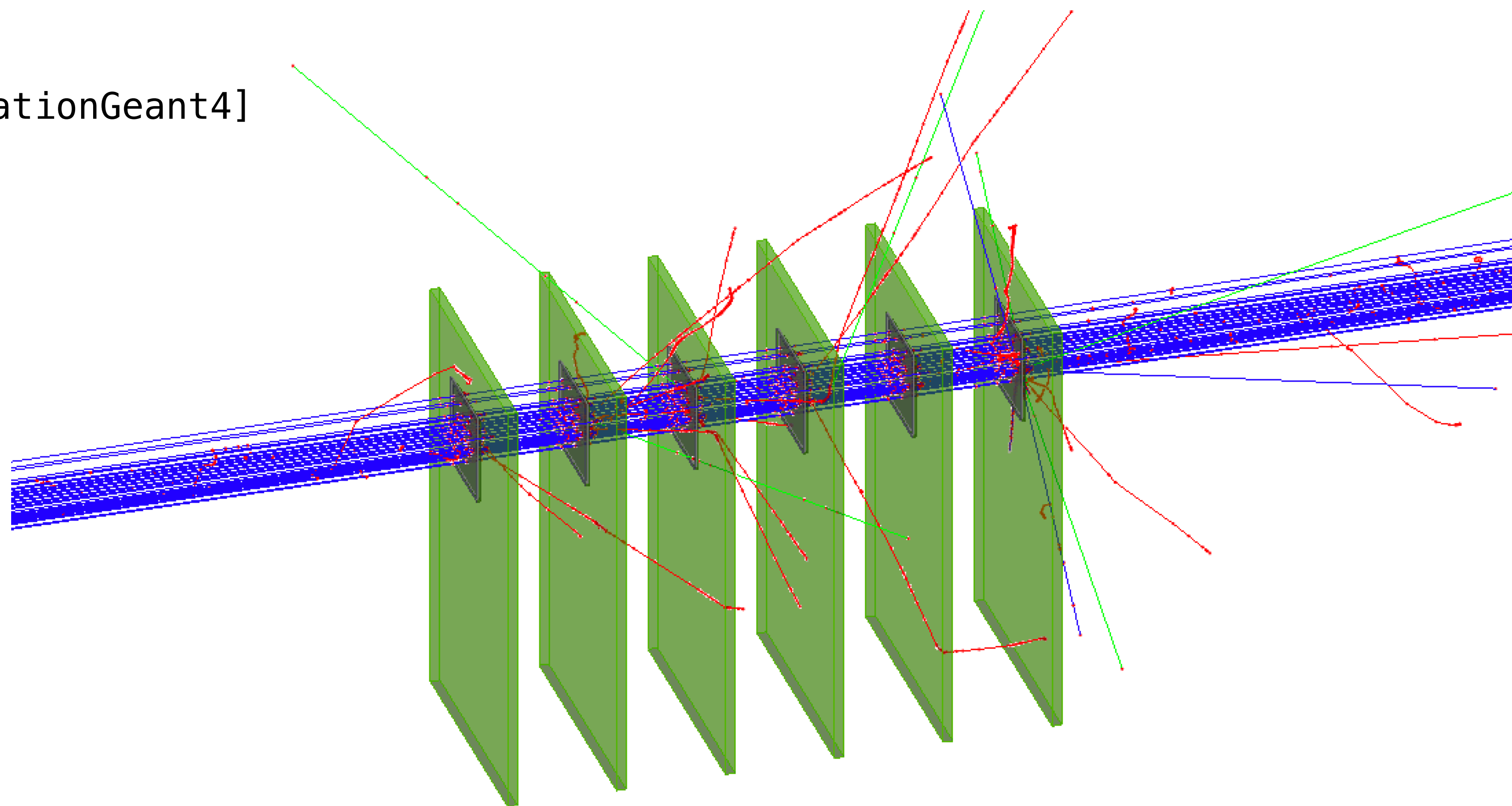

Corryvreckan - testbeam reconstruction software

```
[Allpix]
number_of_events = 1000
detectors_file = "tutorial-geometry.conf"
log_level = "Warning"
```

```
[GeometryBuilderGeant4]
```

```
[DepositionGeant4]
particle_type = "Pi+"
source_energy = 120GeV
source_type = "beam"
beam_size = 3mm
source_position = 0um 0um -200mm
beam_direction = 0 0 1
physics_list = FTFP_BERT_EMZ
```

```
[ElectricFieldReader]
model="linear"
bias_voltage=-50V
depletion_voltage=-30V
output_plots = 1
```

```
[ProjectionPropagation]
temperature = 293K
output_plots = 1
```

```
[SimpleTransfer]
output_plots = 1
```

```
[DefaultDigitizer]
threshold = 600e
output_plots = 1
```

```
[CorryvreckanWriter]
reference = detector1
dut = dut
```

```
[detector1]
type = "timepix"
position = 0mm 0mm 0mm
orientation = 0 0 0
```

```
[detector2]
type = "timepix"
position = 0mm 0mm 20mm
orientation = 0 0 0
```

```
[detector3]
type = "timepix"
position = 0mm 0mm 40mm
orientation = 0 0 0
```

```
[dut]
type = "timepix"
position = 0mm 0mm 90mm
orientation = 0 45deg 0
```

```
[detector4]
type = "timepix"
position = 0mm 0mm 140mm
orientation = 0 0 0
```

```
[detector5]
type = "timepix"
position = 0mm 0mm 160mm
orientation = 0 0 0
```

```
[detector6]
type = "timepix"
position = 0mm 0mm 180mm
orientation = 0 0 0
```

Processing detectors in different ways

When we added more detectors to the geometry file, everything took care of things under the hood

- No need to add additional information to the simulation configuration file

What is happening is that a separate instance of each module is created per detector

- This allows some measure of multithreading to be used to improve simulation times - all detectors can be run in parallel

This behaviour is controlled by the module type, either it is **unique** or **detector-specific**

A single detector chain

GeometryBuilderGeant4

DepositionGeant4

ElectricFieldReader

ProjectionPropagation

DefaultDigitiser

SimpleTransfer

A multi-detector chain

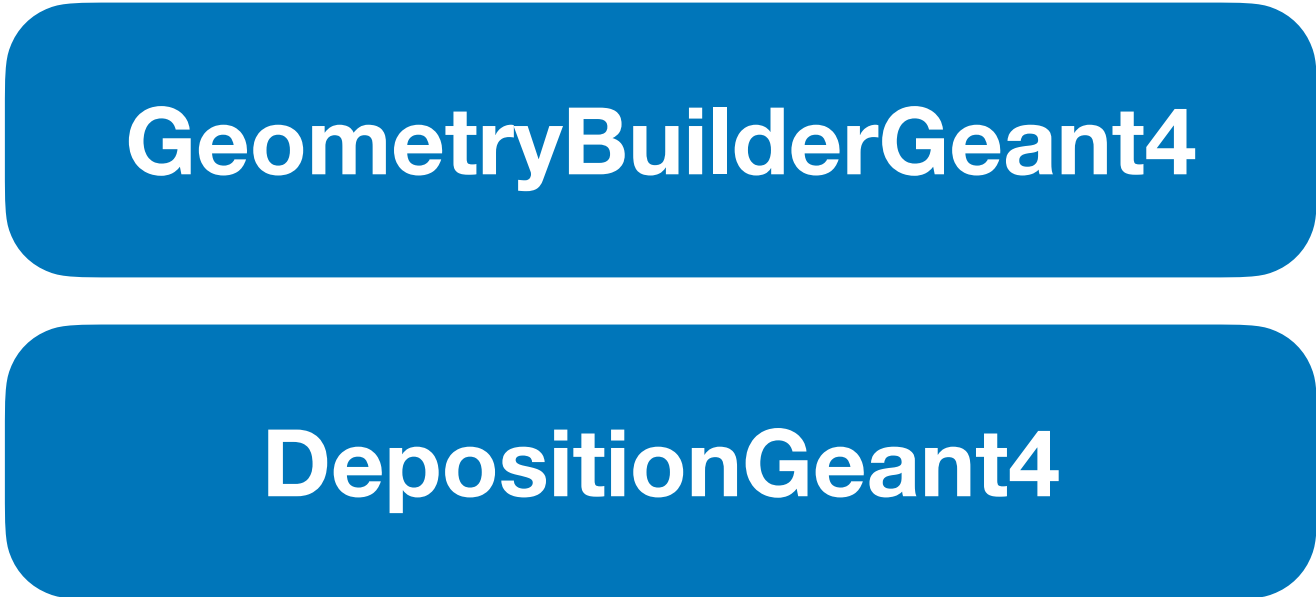

What if ?

GeometryBuilderGeant4

DepositionGeant4

Detector1

Detector2

Detector3

Detector4

Detector5

Detector6

ElectricFieldReader

Detector2

Detector3

Detector4

Detector5

Detector6

ProjectionPropagation

Detector1

GenericPropagator

Detector1

Detector2

Detector3

Detector4

Detector5

Detector6

DefaultDigitiser

Detector1

Detector2

Detector3

Detector4

Detector5

Detector6

SimpleTransfer

Specifying detector type/name

When we added more detectors to the geometry file, everything took care of things under the hood

- No need to specify which detector each module was being applied to

By default, all modules will apply to all detectors. Can overwrite this behaviour by specifying either the **name** or **type** of detector to run over

- We can use this to either make a module have different parameters **per-detector**, or operate on a subset of detectors

Set to operate on all detectors



```
[ElectricFieldReader]
model="linear"
bias_voltage=-50V
depletion_voltage=-30V
```

```
[ElectricFieldReader]
model = "linear"
name = "detector1"
bias_voltage=-100V
depletion_voltage=-30V
```



Instantiation for detector1 will be overwritten by this one, since it is the same type of module and specified only for detector1

Specifying detector type/name

When we added more detectors to the geometry file, everything took care of things under the hood

- No need to specify which detector each module was being applied to

By default, all modules will apply to all detectors. Can overwrite this behaviour by specifying either the **name** or **type** of detector to run over

- We can use this to either make a module have different parameters per-detector, or operate on a **subset of detectors**

```
[ProjectionPropagation]
name = "detector2", "detector3", "detector4", "detector5", "detector6"
temperature = 293K
```

```
[GenericPropagation]
name = "detector1"
temperature = 293K
```

Specifying detector type/name

```
[Allpix]
number_of_events = 1000
detectors_file = "tutorial-geometry.conf"
log_level = "Warning"
```

```
[GeometryBuilderGeant4]
```

```
[DepositionGeant4]
particle_type = "Pi+"
source_energy = 120GeV
source_type = "beam"
beam_size = 3mm
source_position = 0um 0um -200mm
beam_direction = 0 0 1
physics_list = FTFP_BERT_EMZ
```

```
[ElectricFieldReader]
model="linear"
bias_voltage=-50V
depletion_voltage=-30V
output_plots = 1
```

```
[ElectricFieldReader]
model="linear"
name="detector1"
bias_voltage=-100V
depletion_voltage=-30V
output_plots = 1
```

```
[ProjectionPropagation]
temperature = 293K
name = "detector2", "detector3", "detector4",
"detector5", "detector6"
output_plots = 1
```

```
[GenericPropagation]
name = "detector1"
temperature = 293K
output_plots = 1
```

```
[SimpleTransfer]
output_plots = 1
```

```
[DefaultDigitizer]
threshold = 600e
output_plots = 1
```

Single detector chain

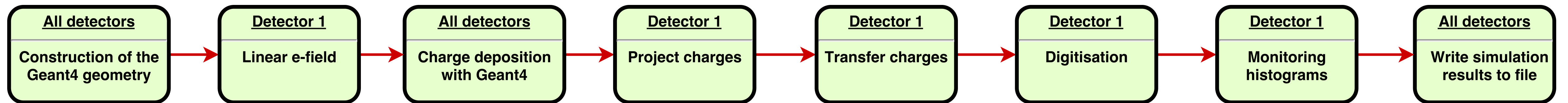

Multi-detector chain

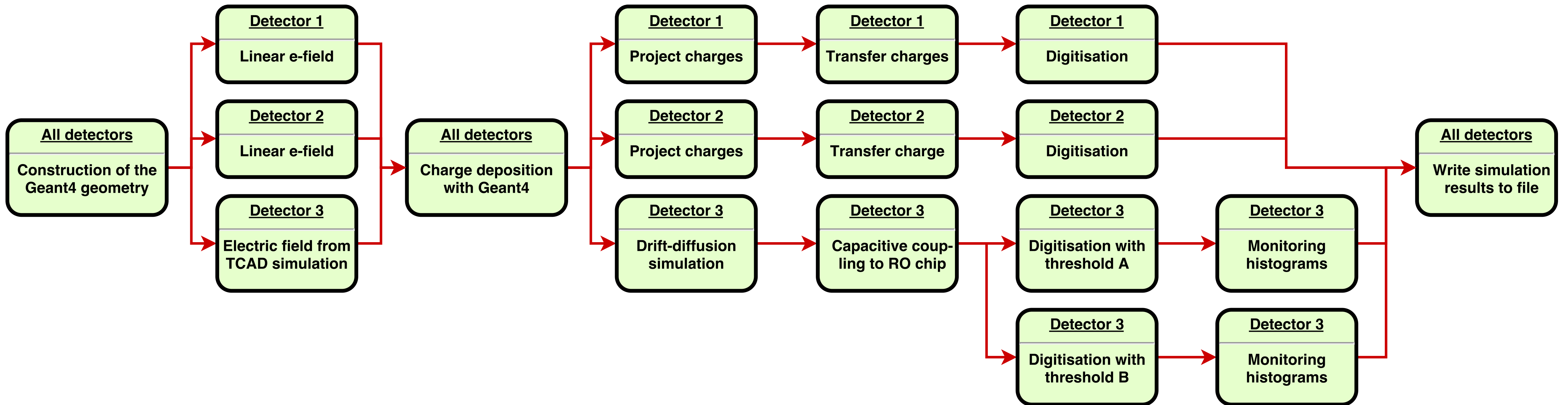

Making your own module

Until now, setting up a simulation and configuring different modules for different detectors

- No need to touch c++ code, only config files

Next step is developing a custom module - keep in mind that modules may already be implemented/can be configured in a way that you need (cf. Digitisation is reasonable generic)

- Consider that making your module generic will benefit other users - no point in implementing 10 times a module to apply time walk effects to an ASIC

Useful script comes with the software to make it easy to develop new modules: `make_modules.sh`

- Define the name of the module
- Whether the module is unique or operates per-detector
- The type of message that the module accepts

Messages

Modules exist entirely standalone in allpix-squared

- Information exchange by dispatching and receiving messages, via the core of the software
- Check performed on start-up for configuration errors - check with messages each module is waiting for and whether messages being dispatched are subsequently used

For per-detector modules, separate messages are dispatched for each detector, with the detector name used in the identification

New modules need to decide what objects to pick up

- DepositedCharges, PropagatedCharges, etc.

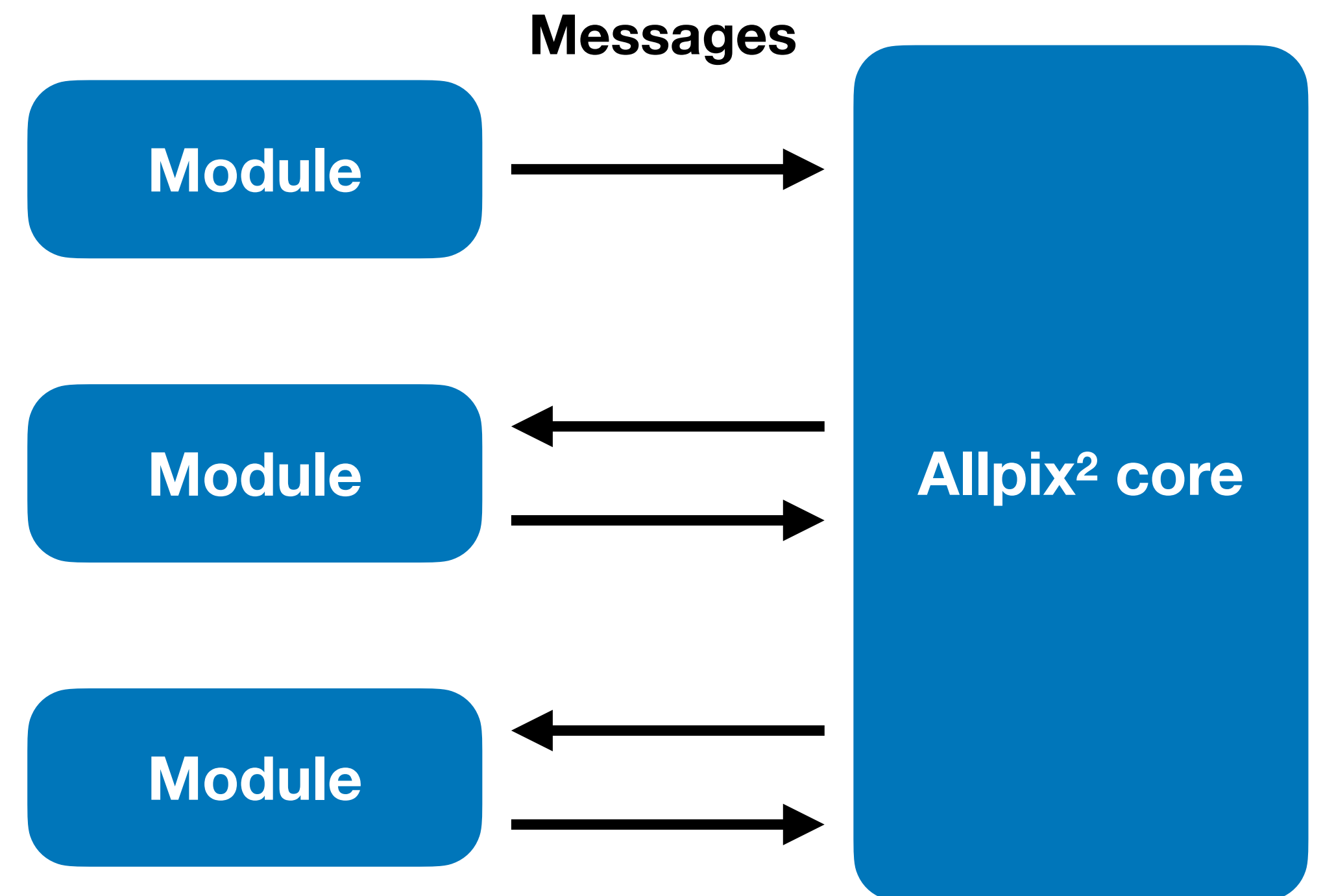

Message types

Inside “src/objects” the complete list of objects can be found, each of which has the message definition alongside it. Objects include:

- DepositedCharge
- PropagatedCharge
- Pulse
- PixelHit
- MCParticle
- Etc.

And are trivial to extend

```
#include "Pixel.hpp"

namespace allpix {
    /**
     * @ingroup Objects
     * @brief Pixel triggered in an event after digitization
     */
    class PixelHit : public Object {
    public:
        /**
         * @brief Construct a digitized pixel hit
         * @param pixel Object holding the information of the pixel
         * @param local_time Timing of the occurrence of the hit in local reference frame
         * @param global_time Timing of the occurrence of the hit in global reference frame
         * @param signal Signal data produced by the digitizer
         * @param pixel_charge Optional pointer to the related pixel charge
         */

        /**
         * @brief Typedef for message carrying pixel hits
         */
        using PixelHitMessage = Message<PixelHit>;
    };
};
```

Producing your own module

```
$ cd ../etc/scripts/  
$ ./make_module.sh
```

Preparing code basis for a new module:

```
Name of the module? TutorialExample  
Short description of the module? This module will demonstrate how to write a new module  
Type of the module?
```

```
1) unique  
2) detector  
#? 2  
Event order requirements?
```

```
1) Module  
2) SequentialModule  
#? 1
```

```
Input message type? DepositedCharge  
Creating directory and files...
```

```
./make_module.sh: line 162: realpath: command not found  
Name: TutorialExample  
Description: This module will demonstrate how to write a new module  
Author: Daniel Hynds (daniel.hynds@cern.ch)  
Path:  
This module listens to "DepositedCharge" messages from one detector
```

Re-run CMake in order to build your new module.

Writing your own module

```
1 /**
2  * @file
3  * @brief Implementation of TutorialExample module
4  *
5  * @copyright Copyright (c) 2017-2023 CERN and the Allpix Squared authors.
6  * This software is distributed under the terms of the MIT License, copied verbatim in the file "LICENSE.md".
7  * In applying this license, CERN does not waive the privileges and immunities granted to it by virtue of its status as an
8  * Intergovernmental Organization or submit itself to any jurisdiction.
9  * SPDX-License-Identifier: MIT
10 */
11
12 #include "TutorialExampleModule.hpp"
13
14 #include <string>
15 #include <utility>
16
17 #include "core/utils/log.h"
18
19 using namespace allpix;
20
21 TutorialExampleModule::TutorialExampleModule(Configuration& config, Messenger* messenger, std::shared_ptr<Detector> detector)
22     : Module(config, detector), detector_(std::move(detector)), messenger_(messenger) {
23
24     // Allow multithreading of the simulation. Only enabled if this module is thread-safe. See manual for more details.
25     // allow_multithreading();
26
27     // Set a default for a configuration parameter, this will be used if no user configuration is provided:
28     config_.setDefault<int>("setting", 13);
29
30     // Parsing of the parameter "setting" into a member variable for later use:
31     setting_ = config_.get<int>("setting");
32
33     // Messages: register this module with the central messenger to request a certain type of input messages:
34     messenger_>bindSingle<DepositedChargeMessage>(this, MsgFlags::REQUIRED);
35 }
36
37 void TutorialExampleModule::initialize() {
38
39     // In this simple case we just print the name of this detector:
40     LOG(DEBUG) << "Detector with name " << detector_>getName();
41 }
42
43 void TutorialExampleModule::run(Event* event) {
44
45     // Messages: Fetch the (previously registered) messages for this event from the messenger:
46     auto message = messenger_>fetchMessage<DepositedChargeMessage>(this, event);
```

Initialise variables/
histograms etc.



Main code, executed
each event

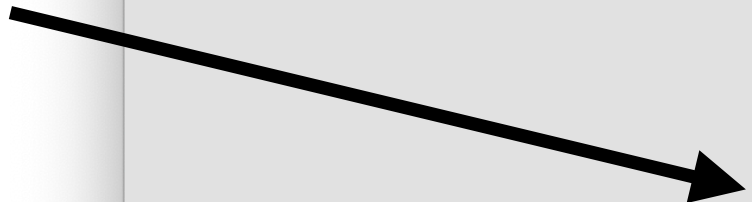

Compiling and including your module

CMake set up to compile all modules in the corresponding directory

- Just need to rerun cmake from the build directory and compile

Module can then be added in the simulation configuration file in the same way as any other module

```
$ cd ../../build/  
$ cmake ..  
$ make install -j 4
```

```
$ cd ../examples/  
../../bin/allpix -c tutorial-simulation.conf
```

...

[TutorialExample]

...

A few other features - MC history

All objects contain information about where they come from

- Direct link to the preceding object
- All objects link back to original MC particle

Messages templated in the code, so adding a new object is straightforward

- Define the object, must inherit from Object
- Add a definition for the message

```
/**  
 * @brief Typedef for message carrying propagated charges  
 */  
using PropagatedChargeMessage = Message<PropagatedCharge>;
```

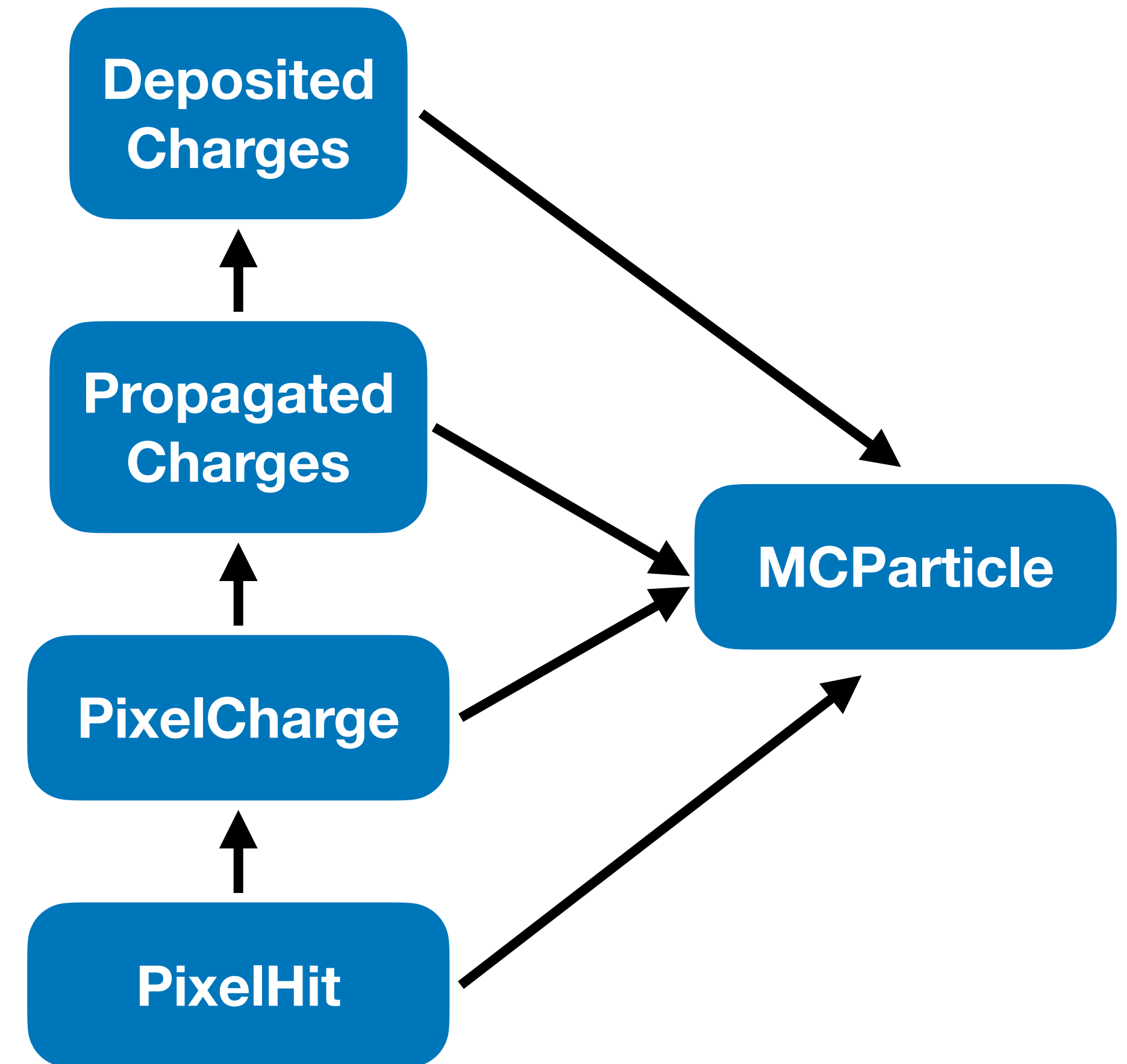

A few other features - output writing

Several output formats are already supported

- LCIO - format used in linear collider community
- RCE - ATLAS pixel group data format
- Corryvreckan - reconstruction framework developed in EP-LCD
- Text files - simple human-readable format
- RootObjects - allpix-squared data

This last class writes out native allpix-squared objects, such that they can be read in again by the framework

- Allows intermediate file-writing to avoid repeating CPU-intensive parts of the simulation
- eg. Write out propagated charge objects so that tuning of the digitisation parameters does not require re-running Geant4 and propagation code

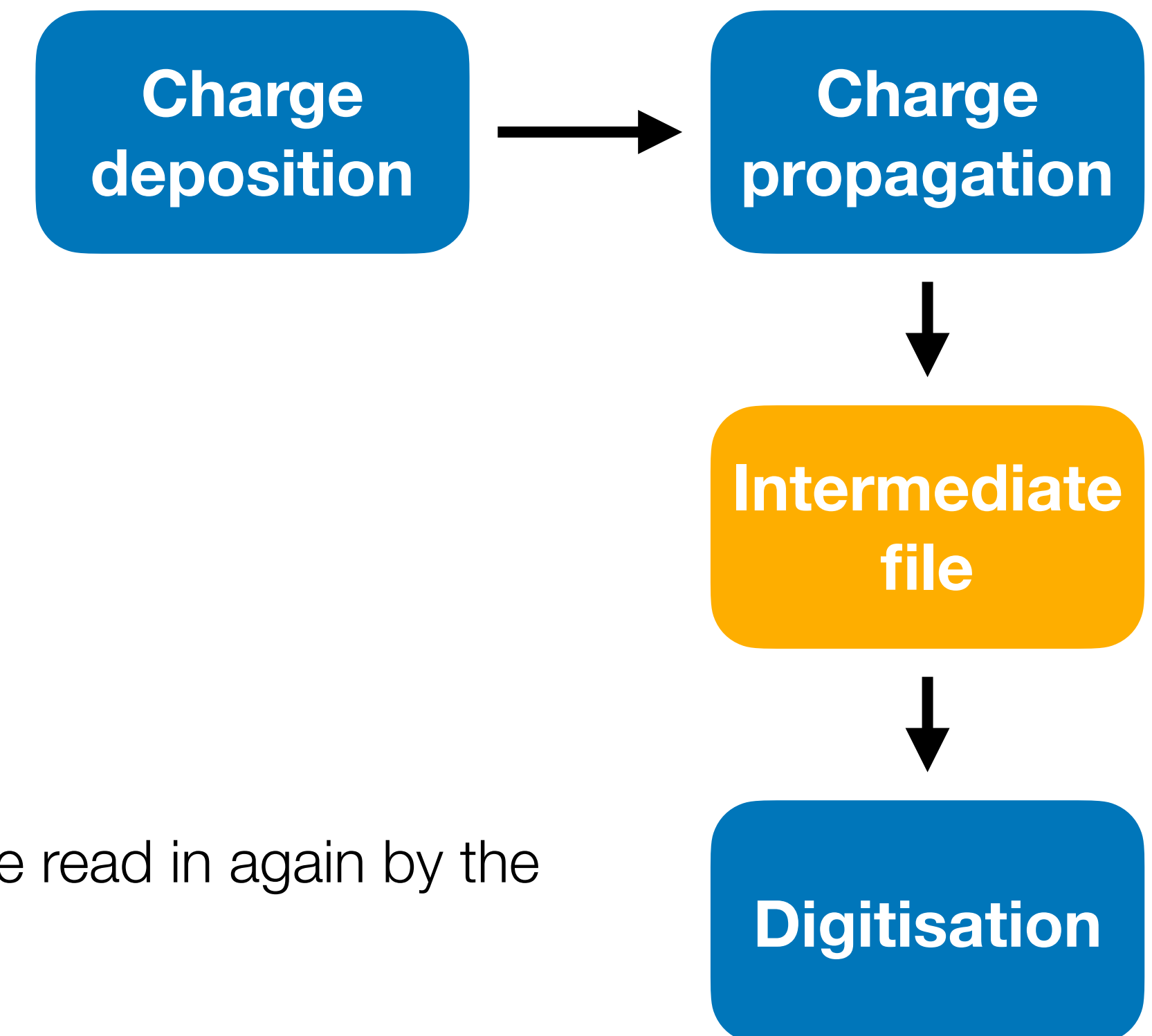

A few other features - geometry

Currently-implemented geometries are for hybrid and monolithic detectors

- Monolithic can be used for strip detectors, with 1 by n “pixels” of appropriate size

Geometry can be configured with cut-outs in the PCB, support materials (windows/physical supports), bump dimensions, etc.

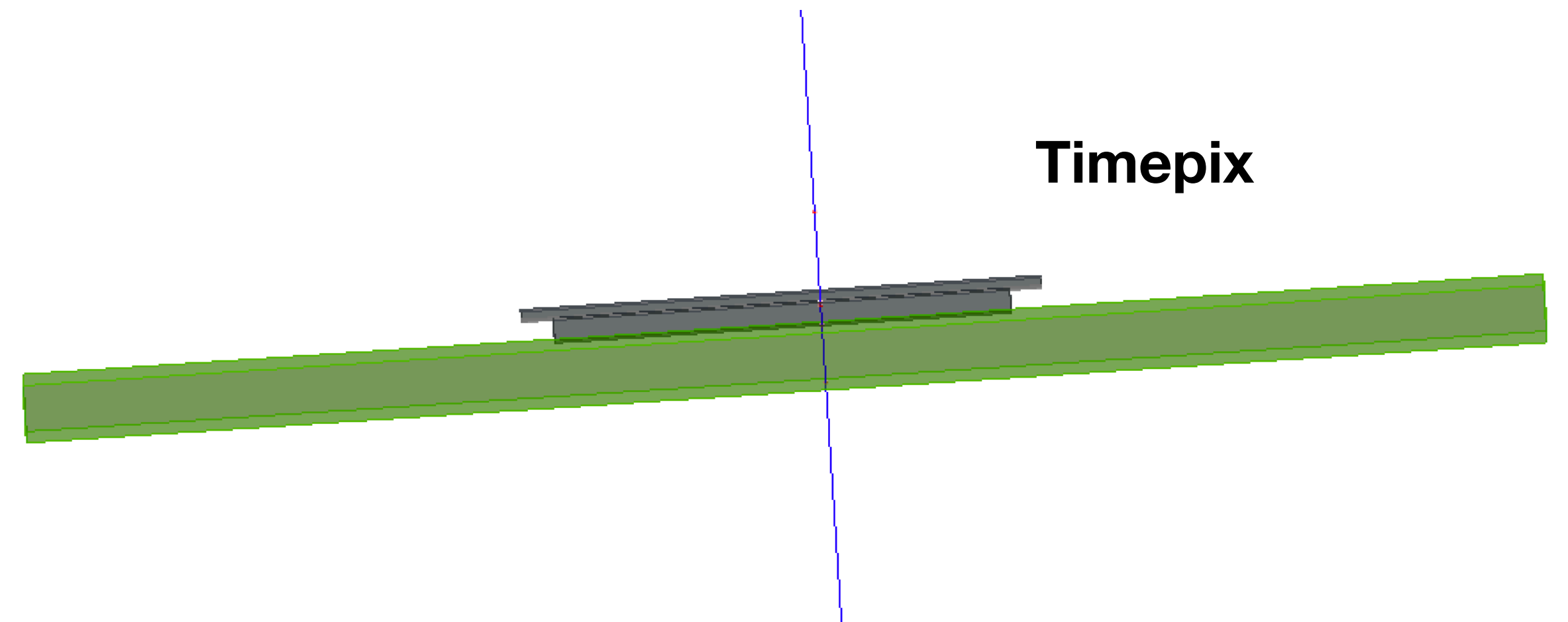
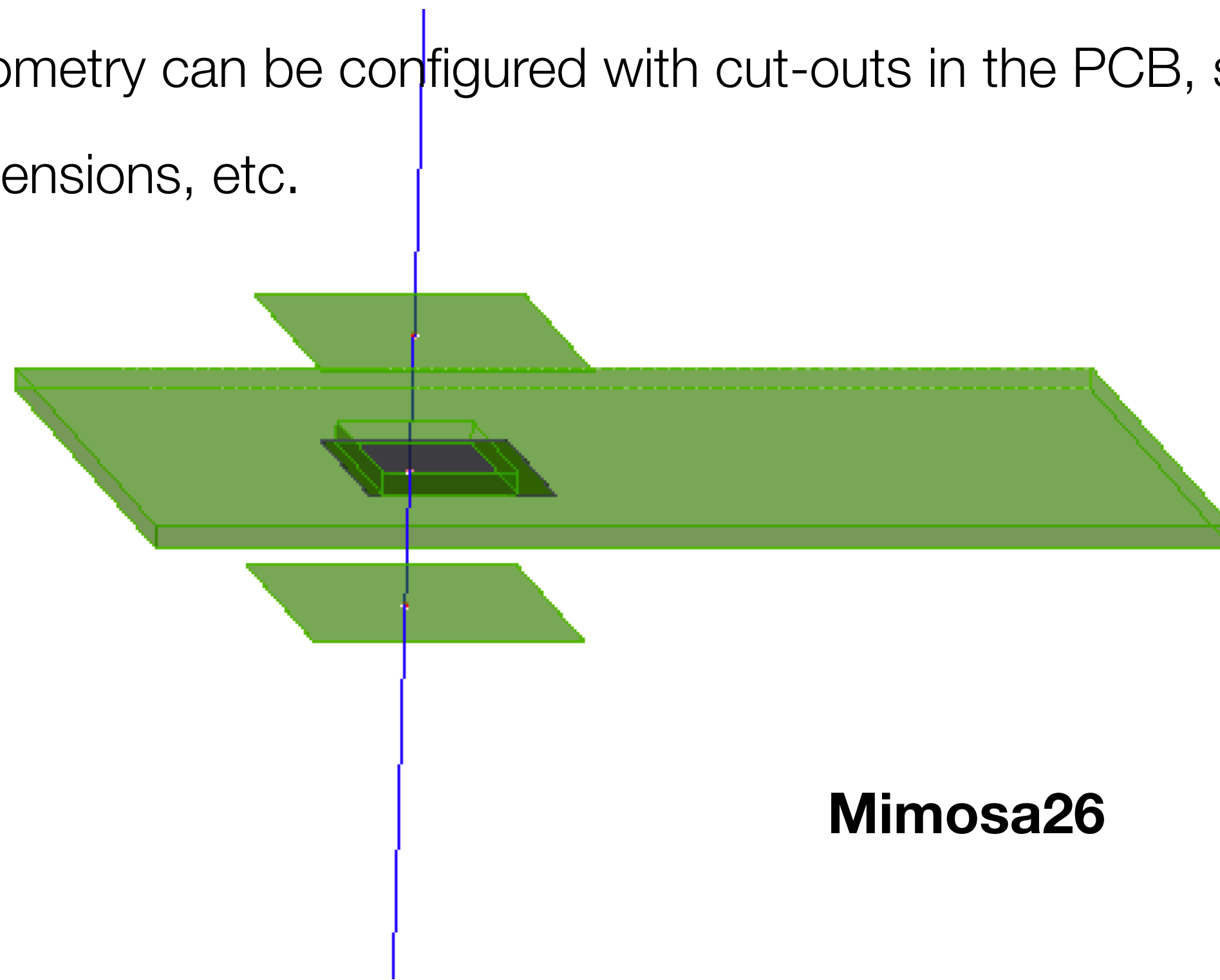

A few highlights of what is currently there

Electric and weighting field import from TCAD - 1

S.Spannagel et al, NIMA 964 (2020) 163784

TCAD field input is essential for more complex electric field configurations - particularly monolithic detectors

- Complicated field shape around the collection implants
- Undepleted bulk gives rise to carrier recombination

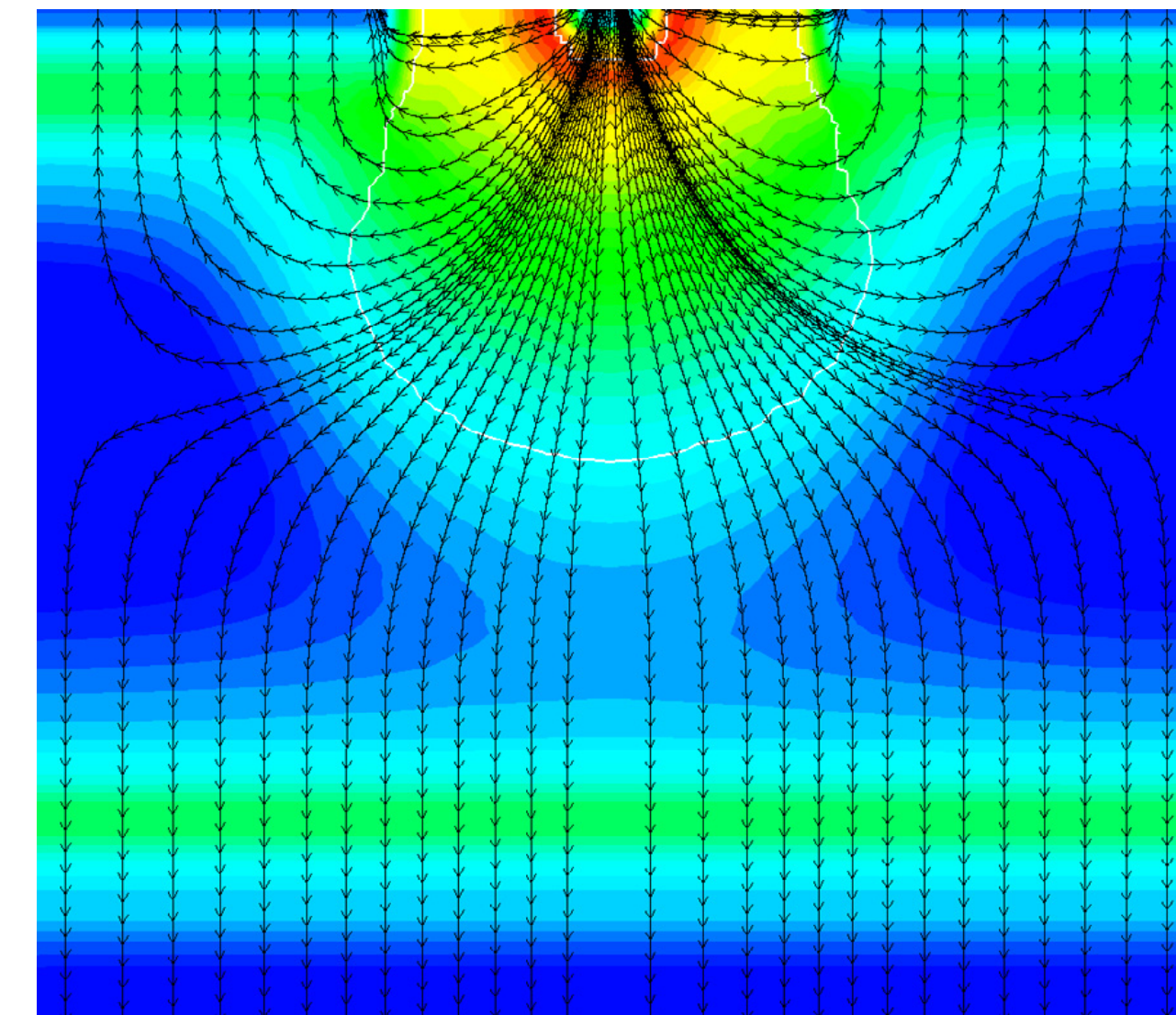
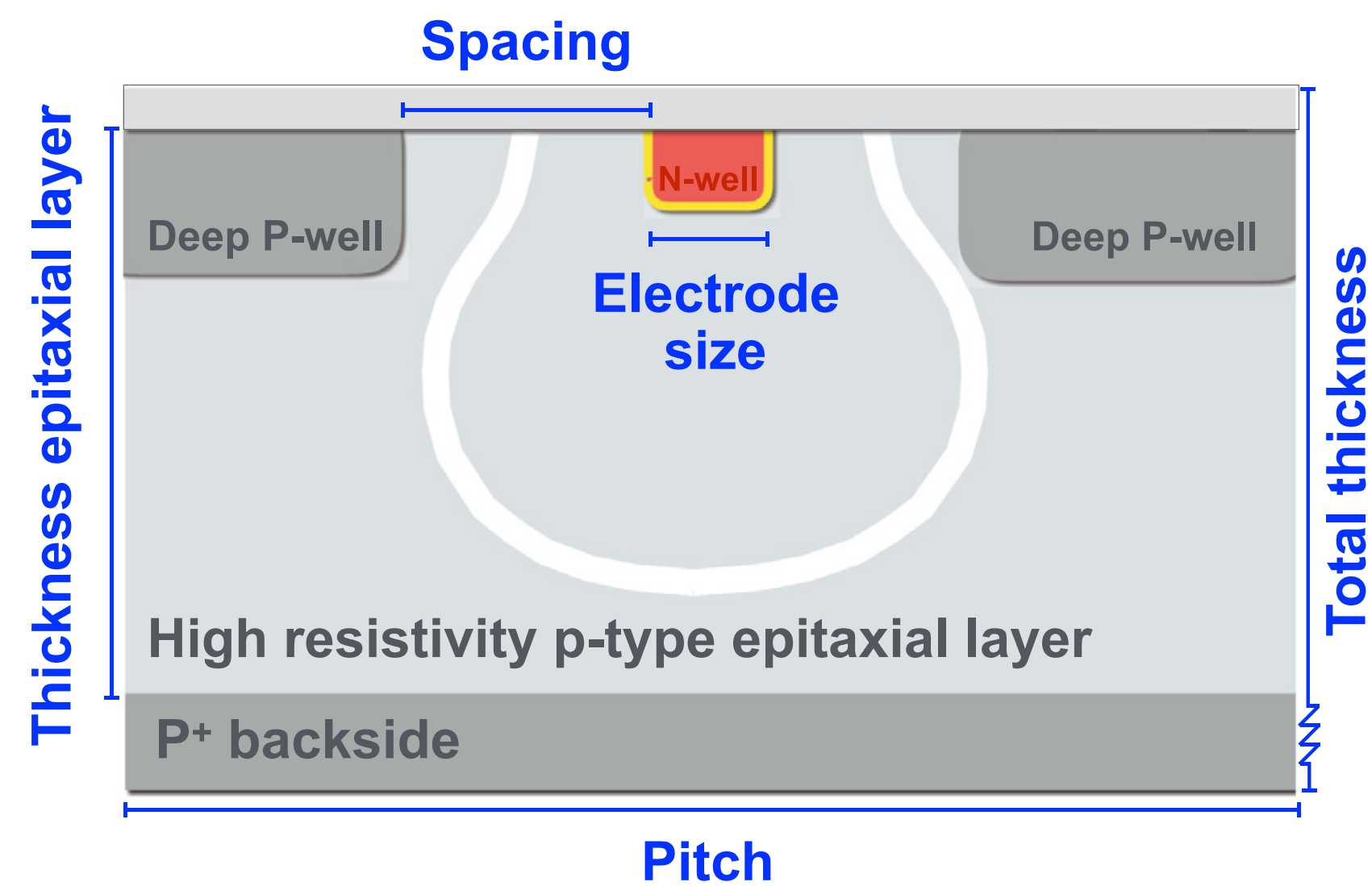

Currently implemented features - weighting field import from TCAD

TCAD field input is essential for more complex electric field configurations - particularly monolithic detectors

- Complicated field shape around the collection implants
- Undepleted bulk gives rise to carrier recombination

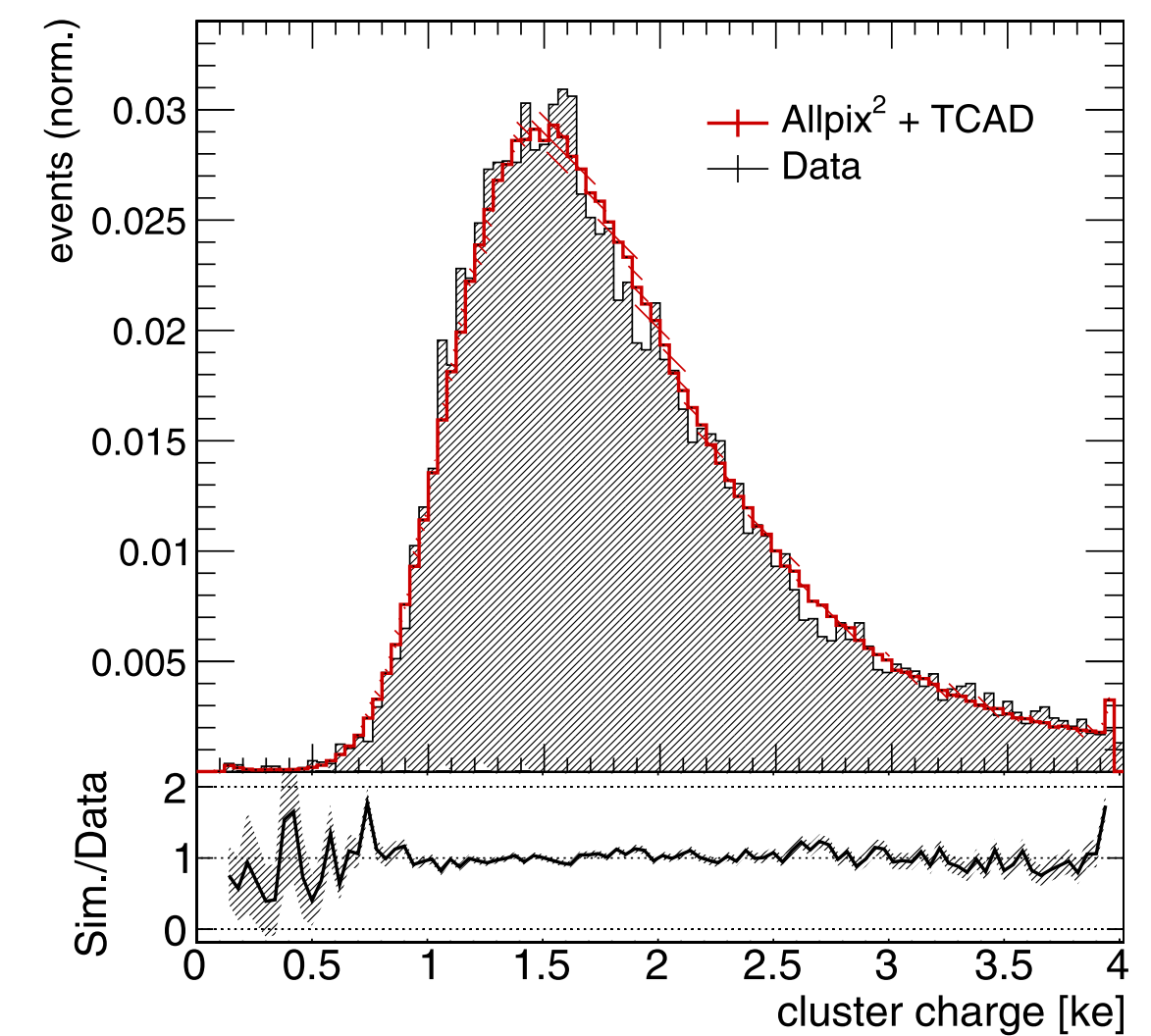
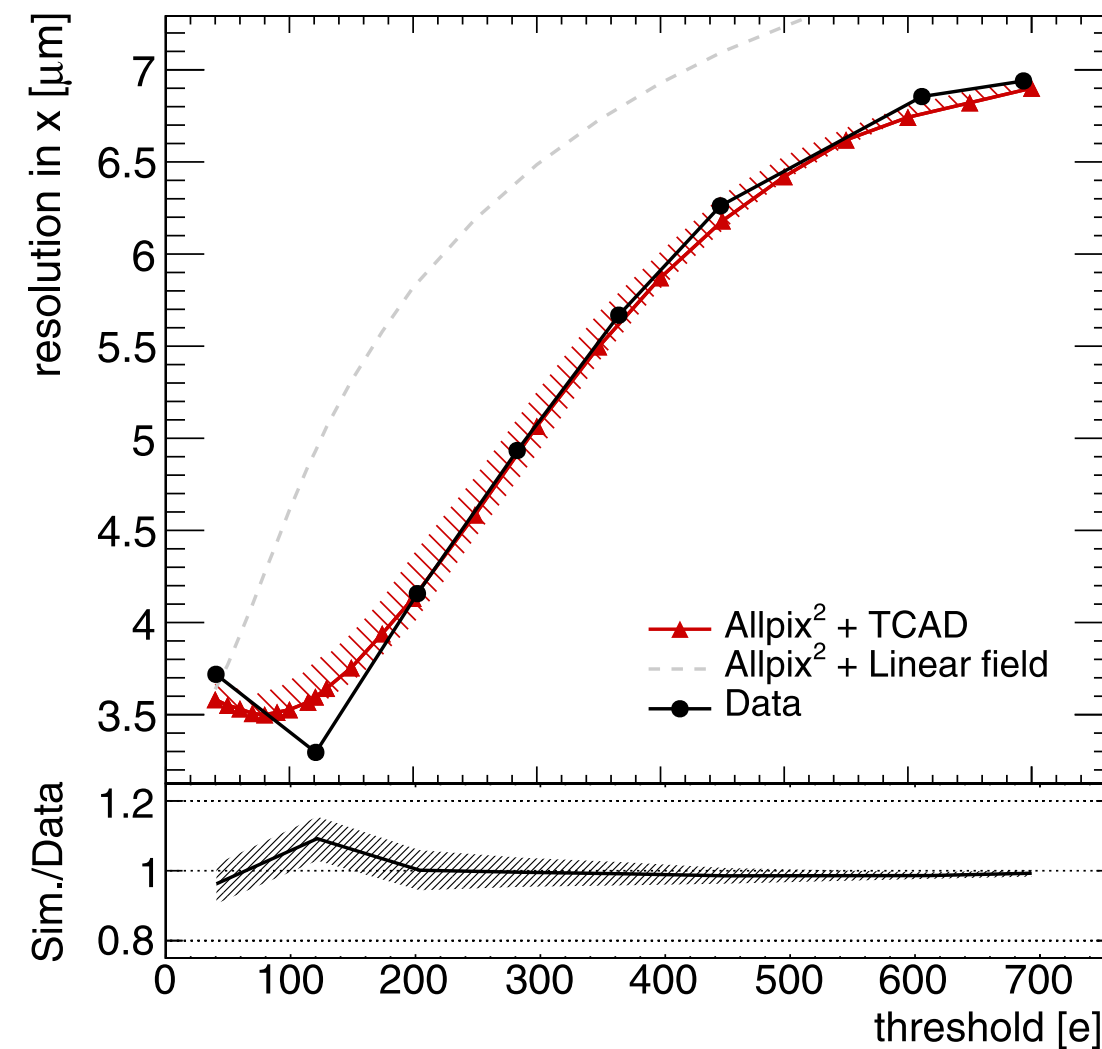
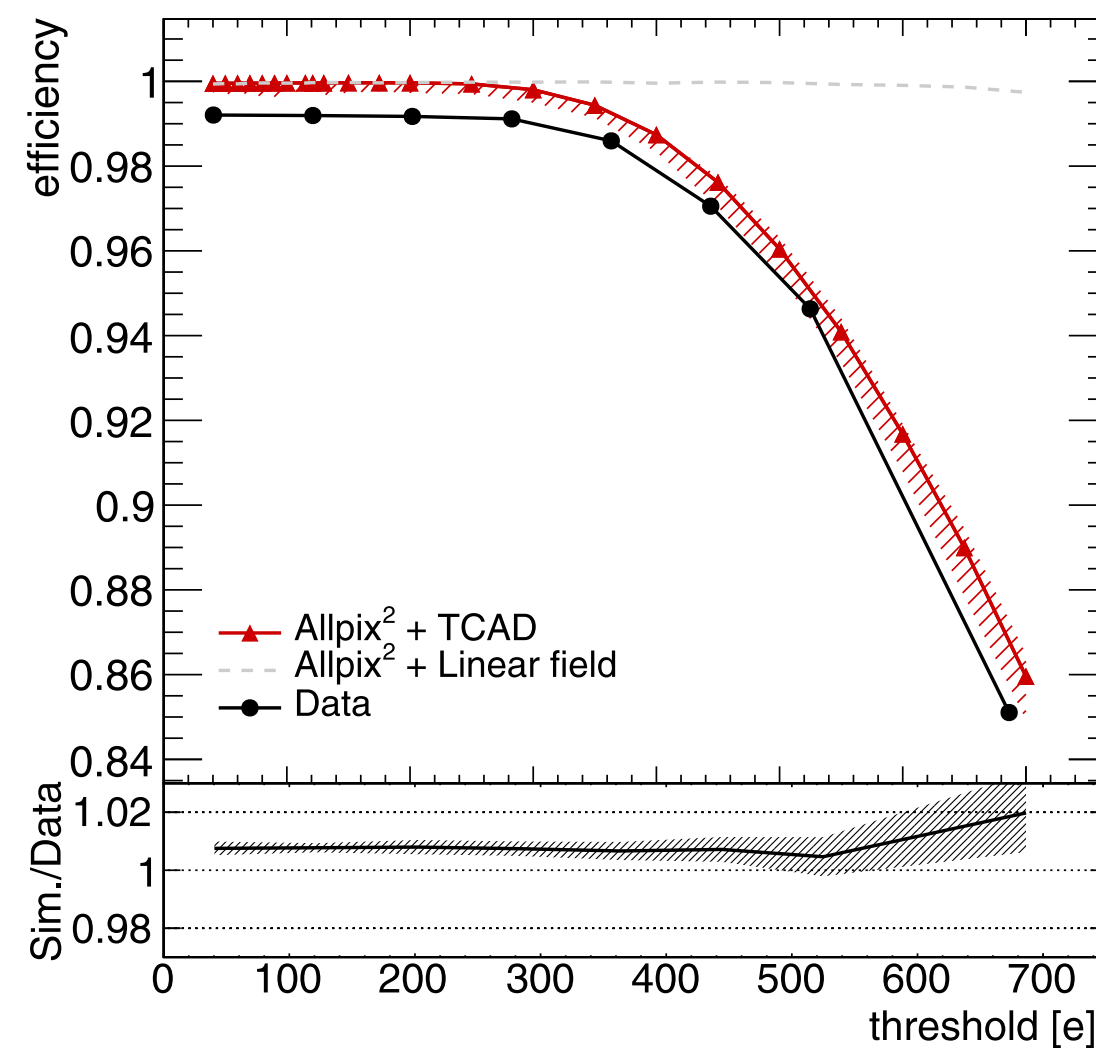

Currently implemented features - weighting field import from TCAD

TCAD field input is essential for more complex electric field configurations - particularly monolithic detectors

- Complicated field shape around the collection implants
- Undepleted bulk gives rise to carrier recombination

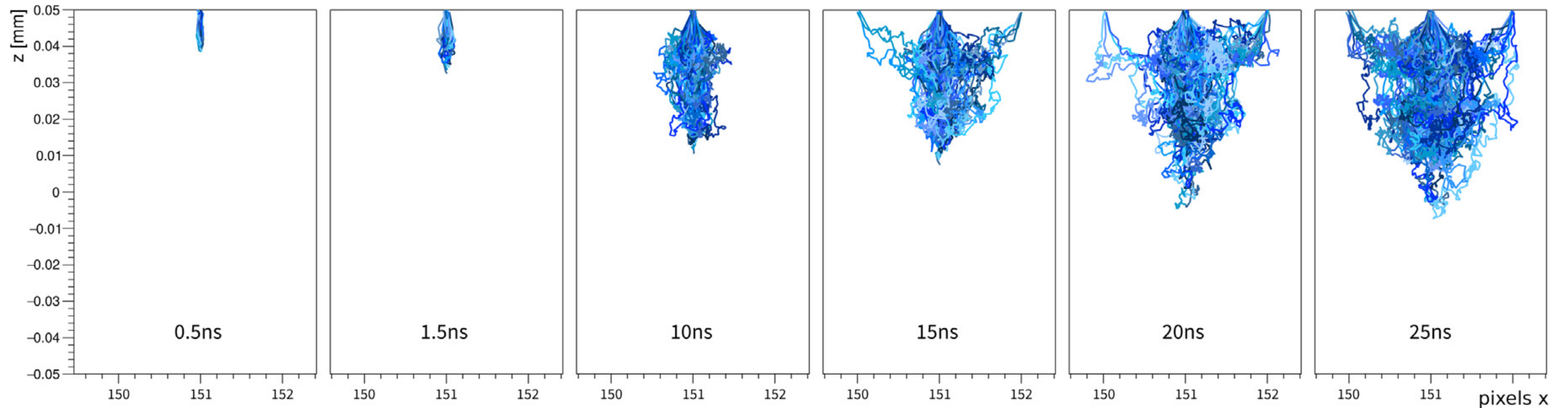

Similar ongoing activities for 65 nm monolithic CMOS developments

- Closely tied to ALICE developments for ITS3
- Similarly complex device where TCAD is combined with Monte Carlo in allpix²

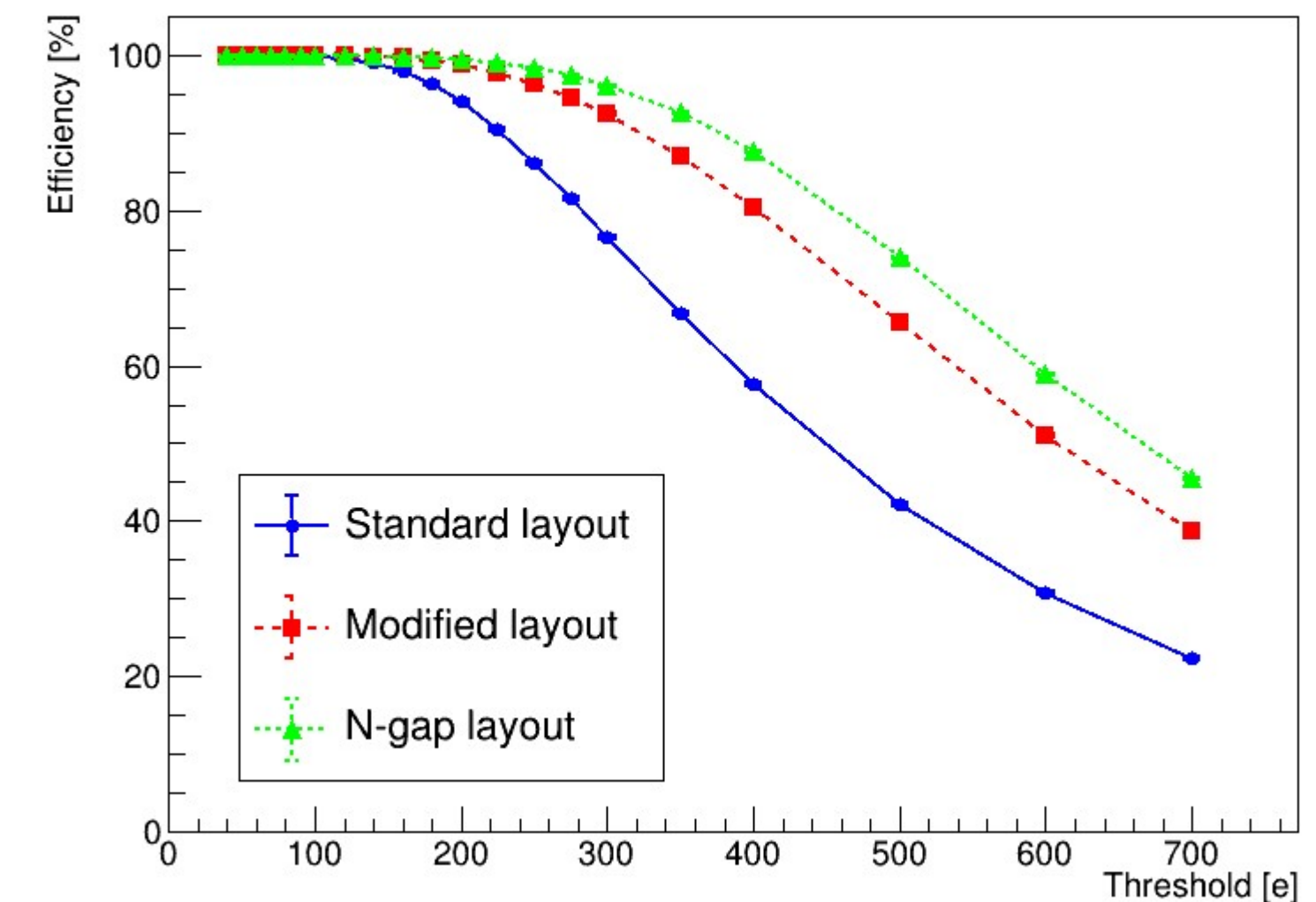
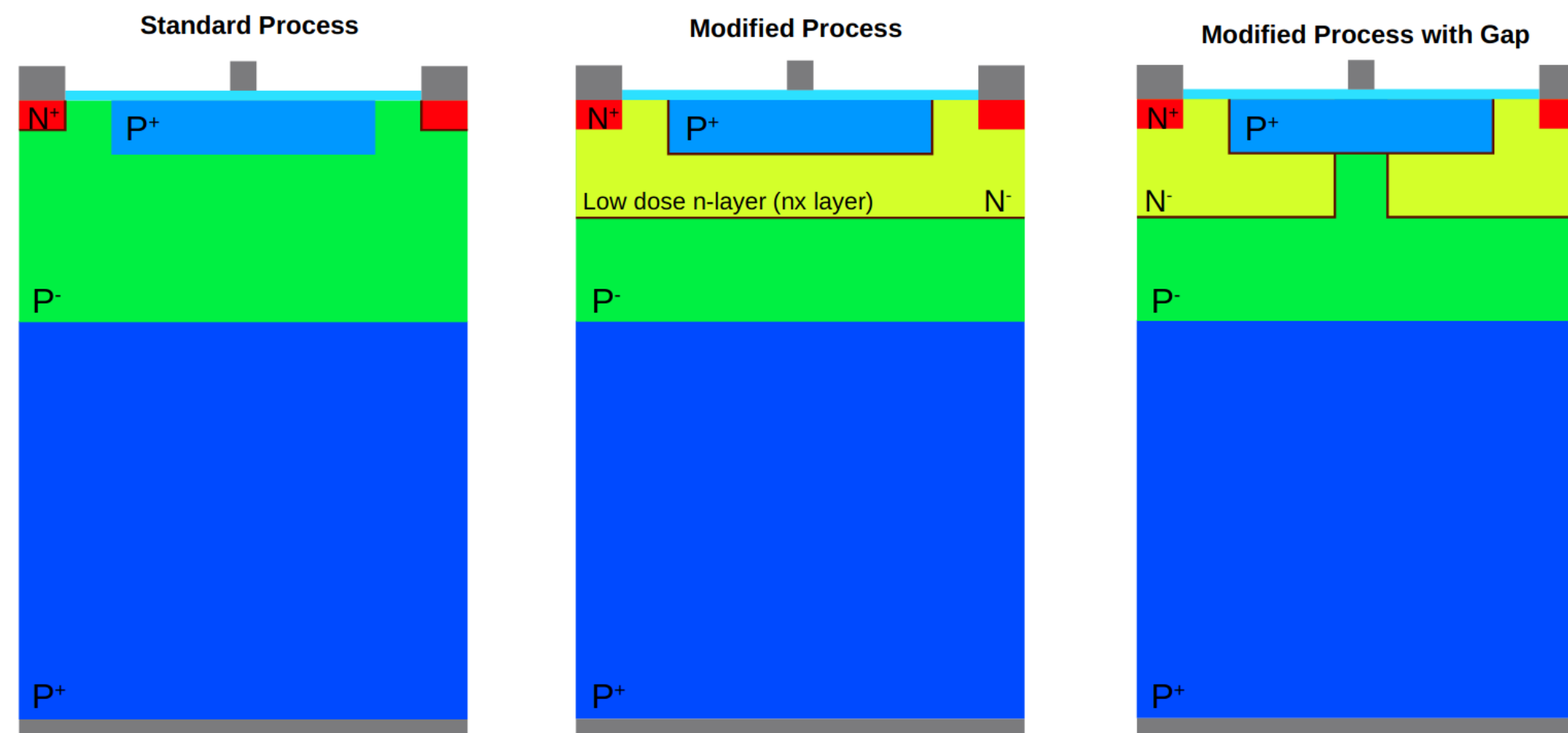

Propagation models

Masetti-Canali

$$\mu(E, N) = \frac{\mu_m(N)}{(1 + (\mu_m(N) \cdot E/v_m)^\beta)^{1/\beta}}$$

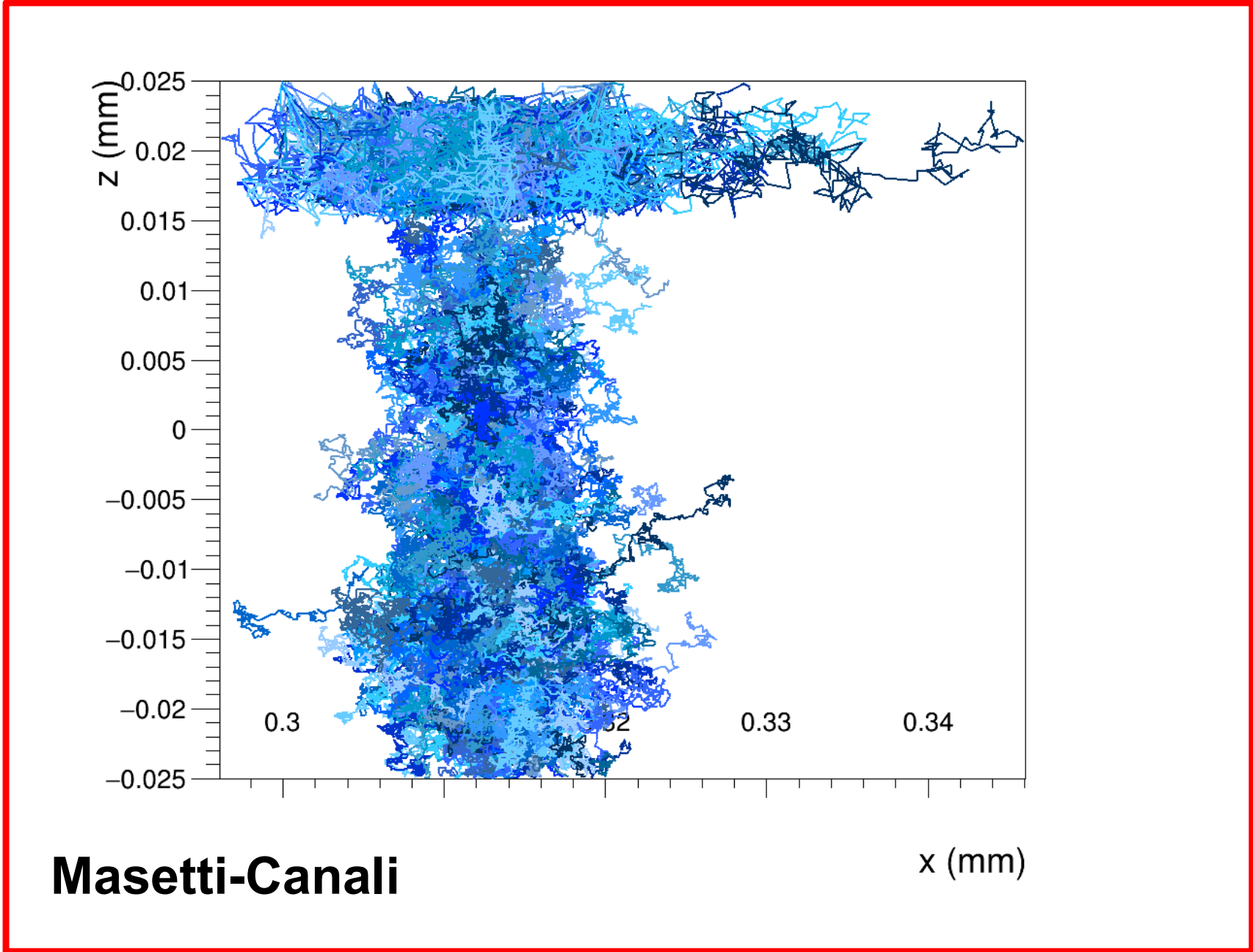

Jacoboni-Canali

$$\mu(E) = \frac{v_m}{E_c} \frac{1}{(1 + (E/E_c)^\beta)^{1/\beta}}$$

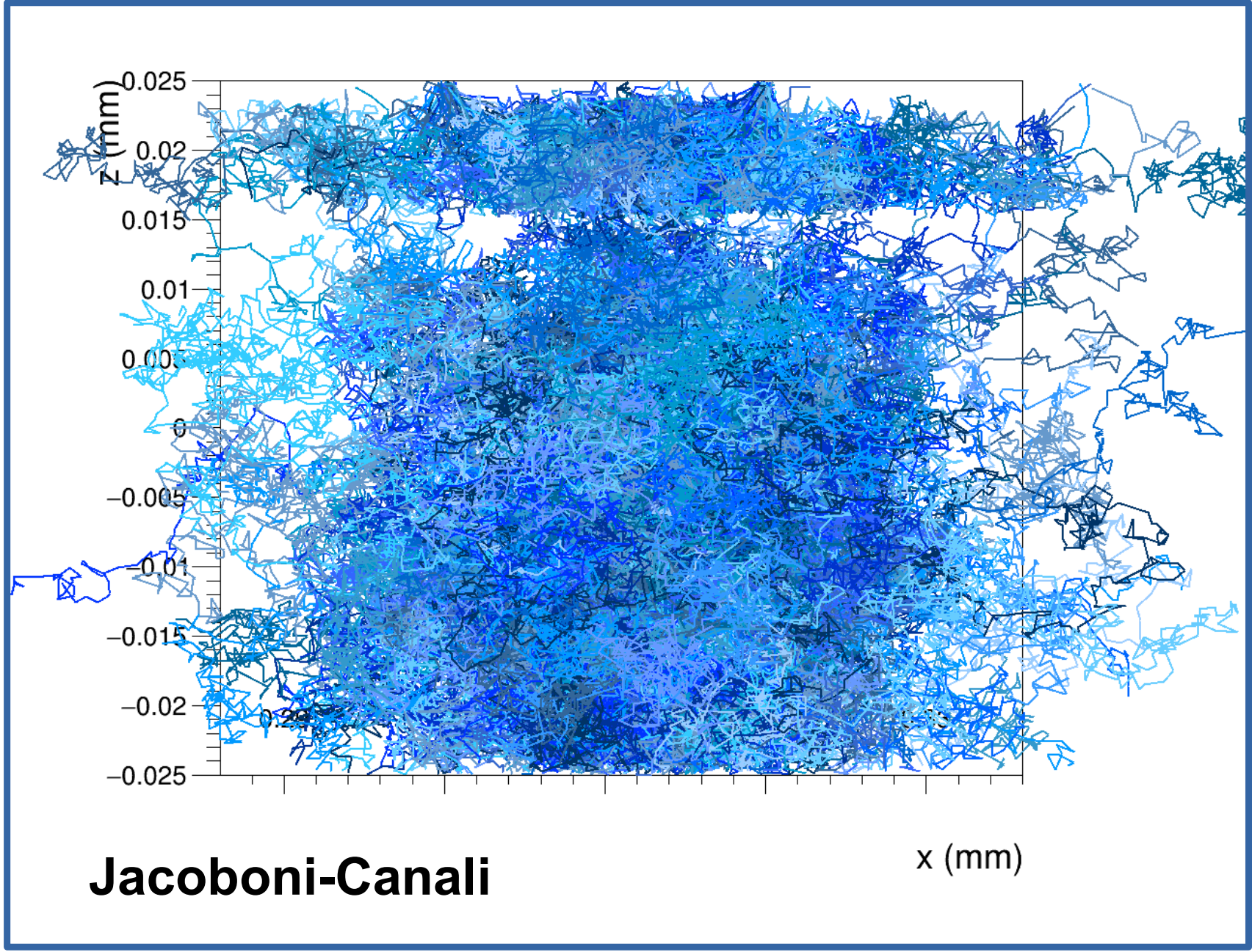

```

mobility_model = "custom"
mobility_function_electrons = "[0]/[1]/pow(1.0+pow(x/[1],[2]),1.0/[2])"
mobility_parameters_electrons = 1.0927393e7cm/s, 6729.24V/cm, 1.0916
mobility_function_holes = "[0]/[1]/pow(1.0+pow(x/[1],[2]),1.0/[2])"
mobility_parameters_holes = 8.447804e6cm/s, 17288.57V/cm, 1.2081
    
```

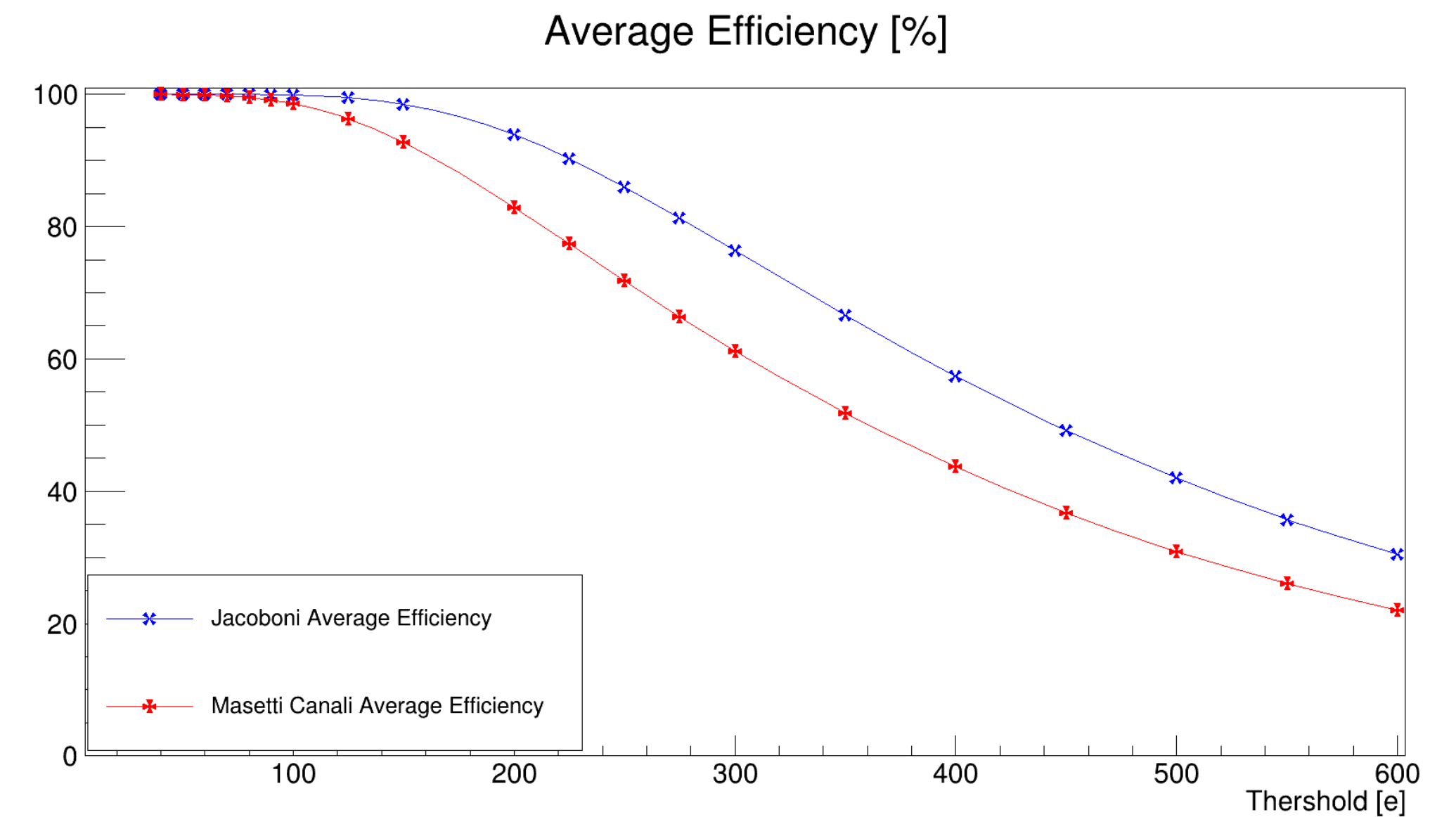
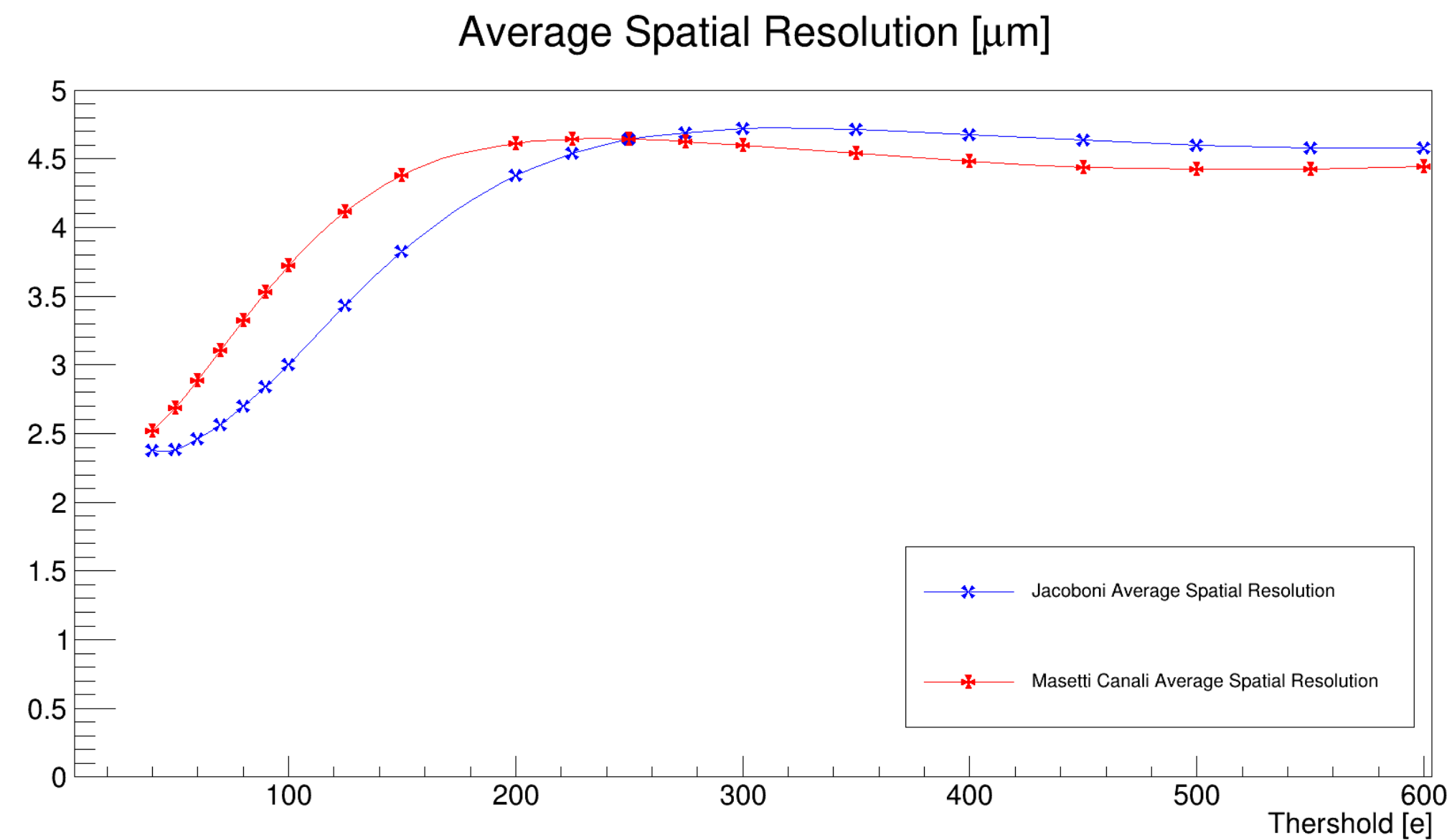

Allpix squared was not originally designed to work with passive materials

- everything was linked to detector models and geometry

- MSc project a few years ago to extend the geometry description and give (easy) access to full Geant4 shape list

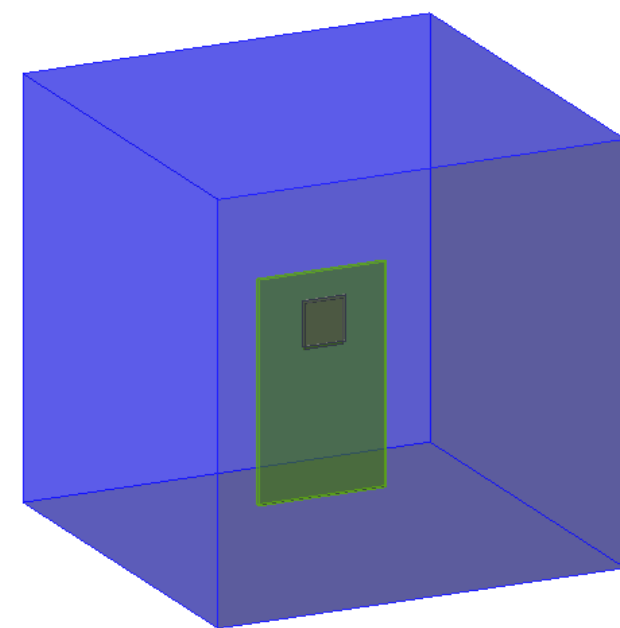

(a) Detector inside a passive material

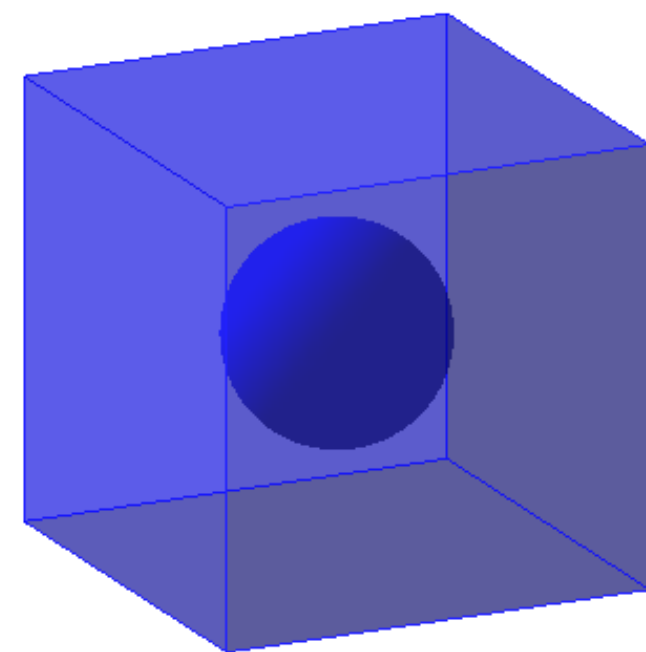

(b) Passive material inside another passive material

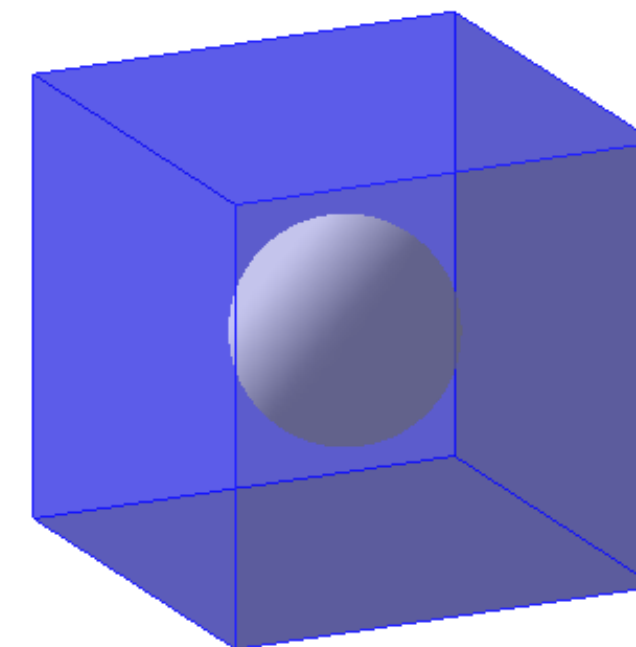

(c) 4.4b with a sphere of World material

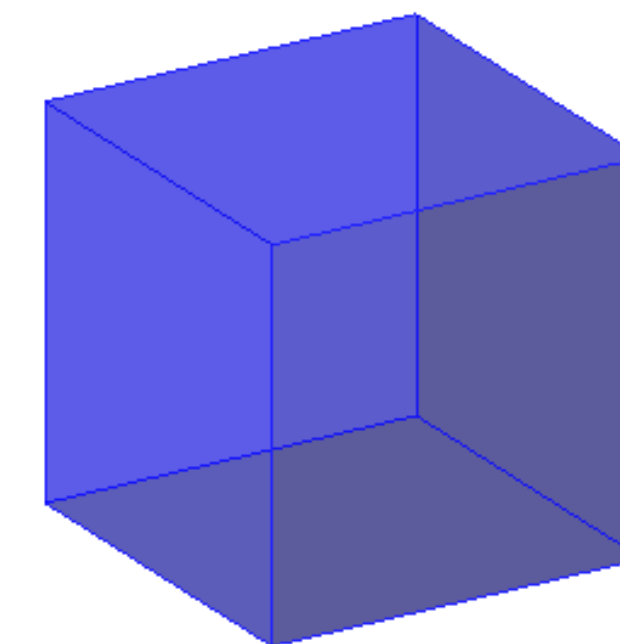

(d) 4.4b with a sphere of the same material as the cube

Passive materials

K.Van Den Brandt, Master Thesis, 2017

Allpix squared was not originally designed to work with passive materials

- everything was linked to detector models and geometry

- MSc project a few years ago to extend the geometry description and give (easy) access to full Geant4 shape list
- Use cases wildly outside of what we envisaged...

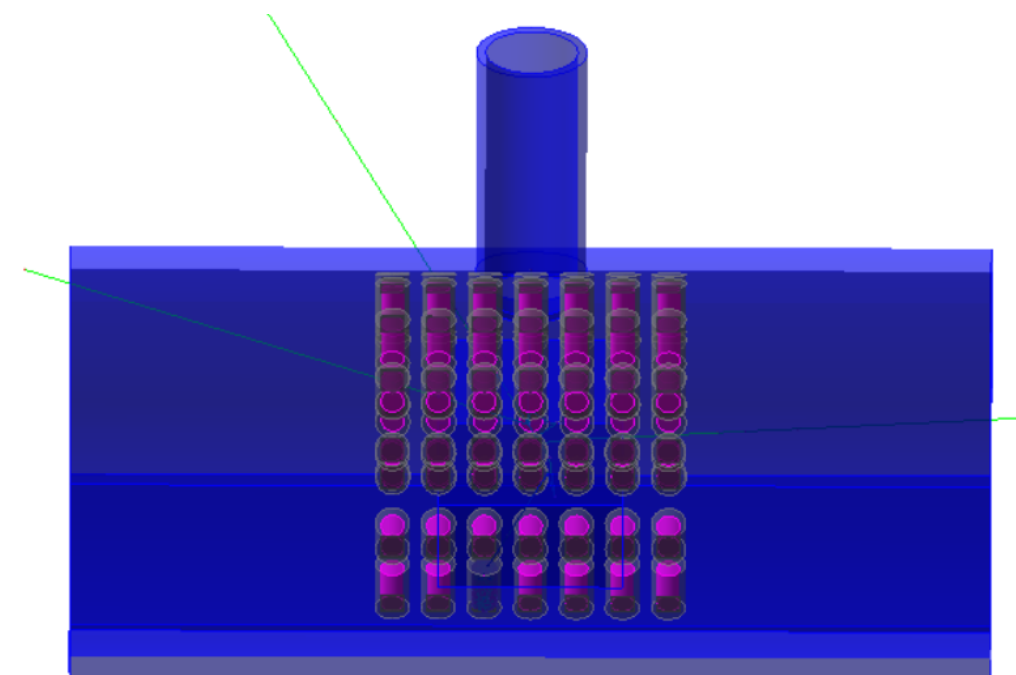
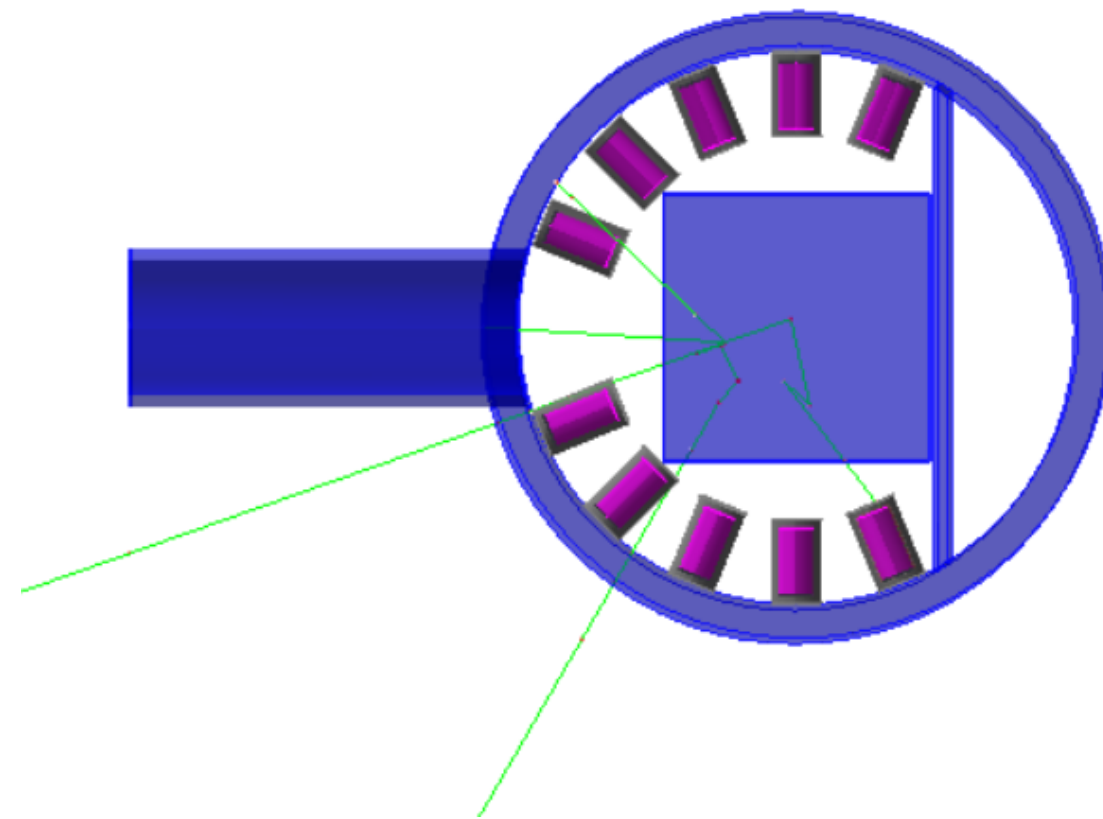

Neutron scanner simulation

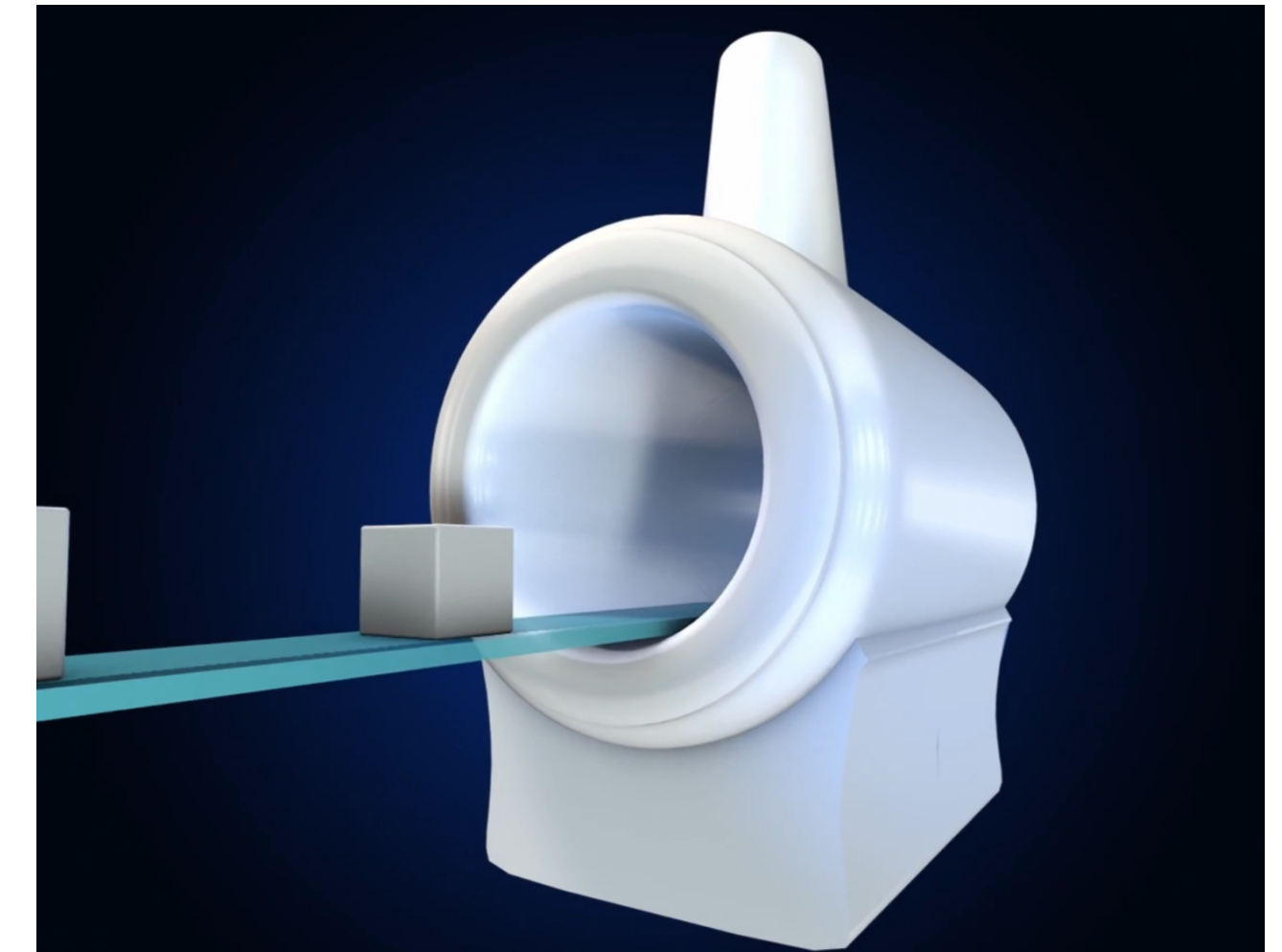

Again, another area where we did not originally imagine going was outside of silicon as the sensor material

- Lots of interest from photon science community for additional materials - GaAs, CdTe, etc.
- Required some re-writing of the core to nicely abstract away the differences and allow relevant properties to be set: Geant4 material, mobility models, electric field calculations...

Table 6.1: List of default sensor material properties implemented in Allpix²

Material	Charge Creation Energy [eV]	Fano factor	Sources
Silicon	3.64	0.115	[25], [26]
Gallium Arsenide	4.2	0.14	[27]
Cadmium Telluride	4.43	0.24	[28], [29]
Cadmium Zinc Telluride $\text{Cd}_{0.8}\text{Zn}_{0.2}\text{Te}$	4.6	0.14	[30], [31]
Diamond	13.1	0.382	[32], [32]
Silicon Carbide (4H-SiC)	7.6	0.1	[33], [34]

Non-silicon materials: GaAs

```

type = "hybrid"
number_of_pixels = 256 256
pixel_size = 55um 55um

sensor_thickness = 500um
sensor_excess = 1mm
sensor_material = "GaAs"

bump_sphere_radius = 9.0um
bump_cylinder_radius = 7.0um
bump_height = 20.0um
chip_thickness = 300um
chip_excess_left = 15um
chip_excess_right = 15um
chip_excess_bottom = 2040um

[support]
thickness = 1.76mm
size = 47mm 79mm
offset = 0 -22.25mm
    
```

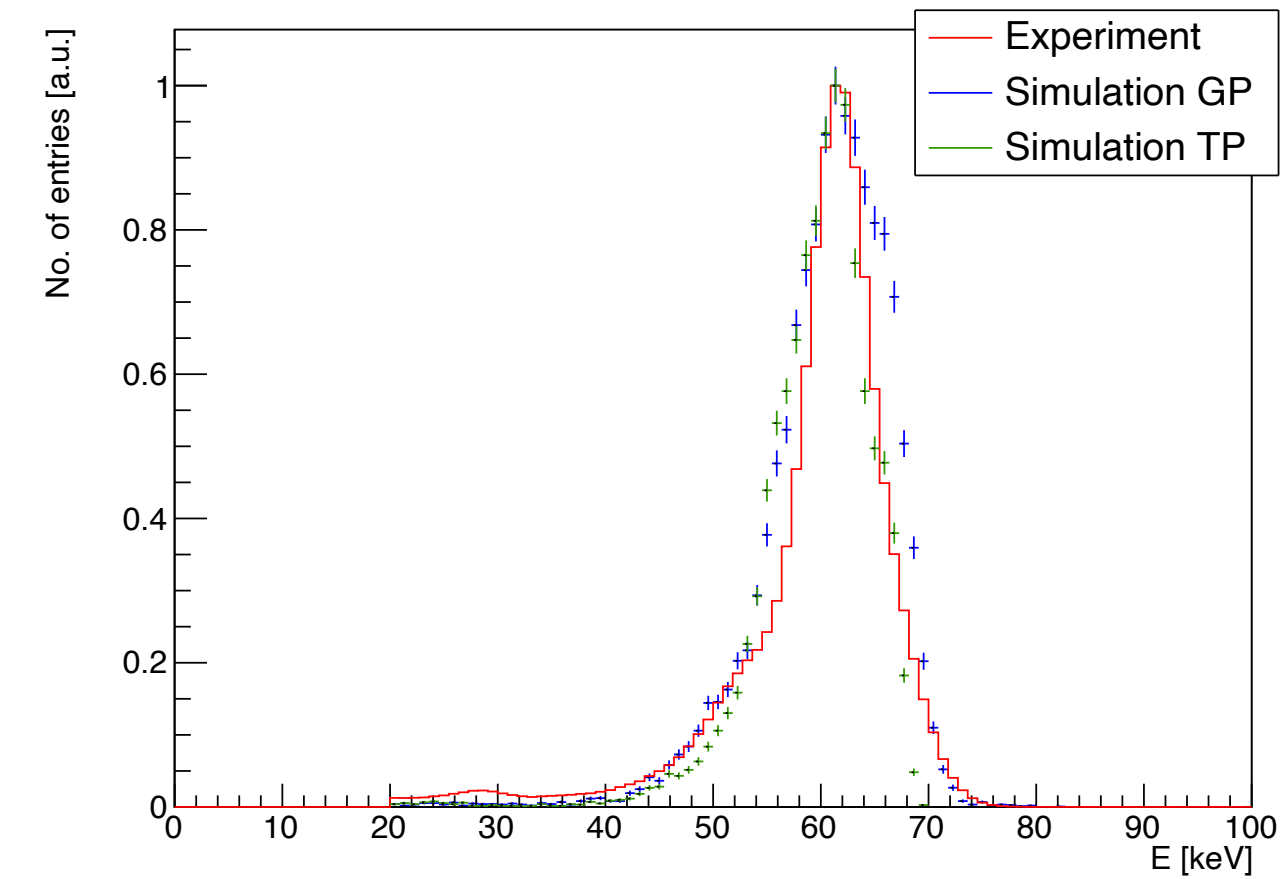
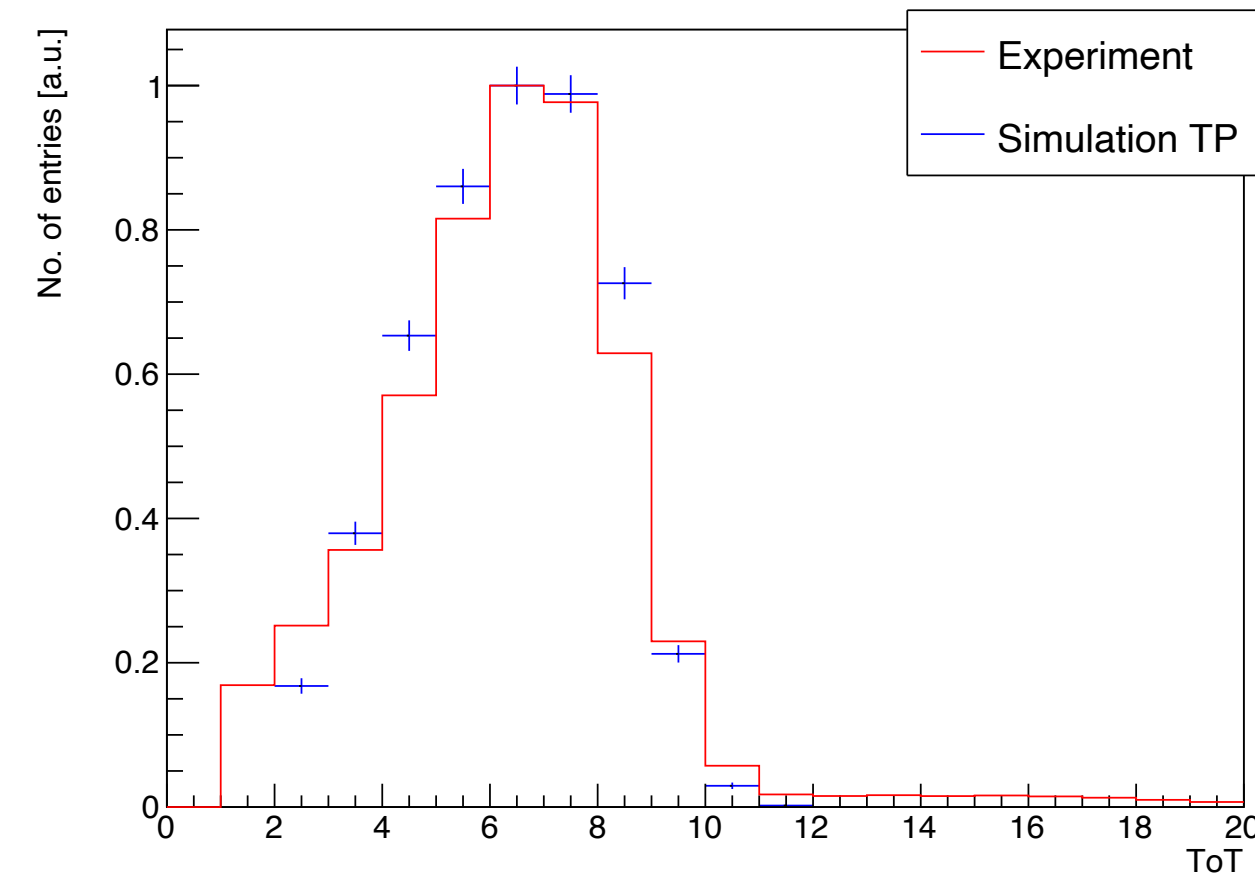
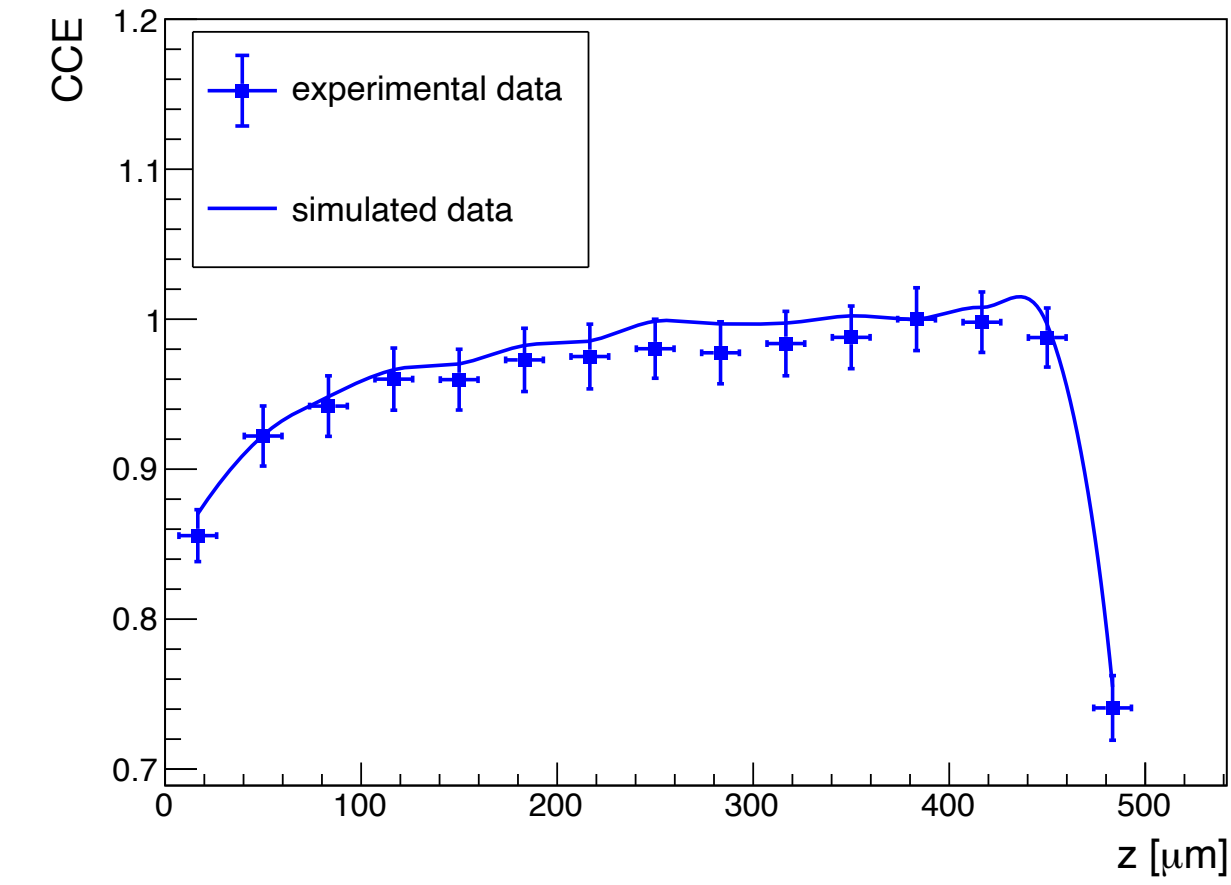
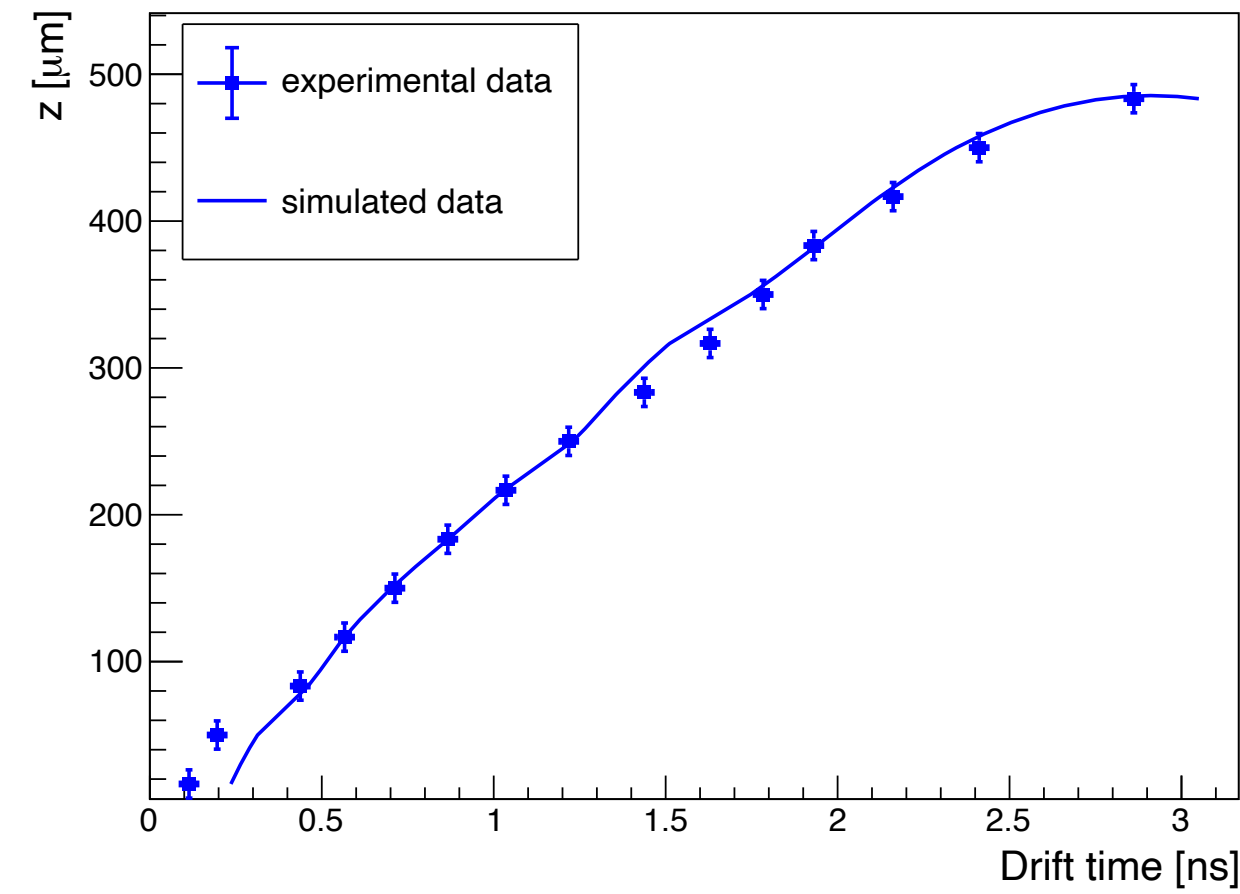
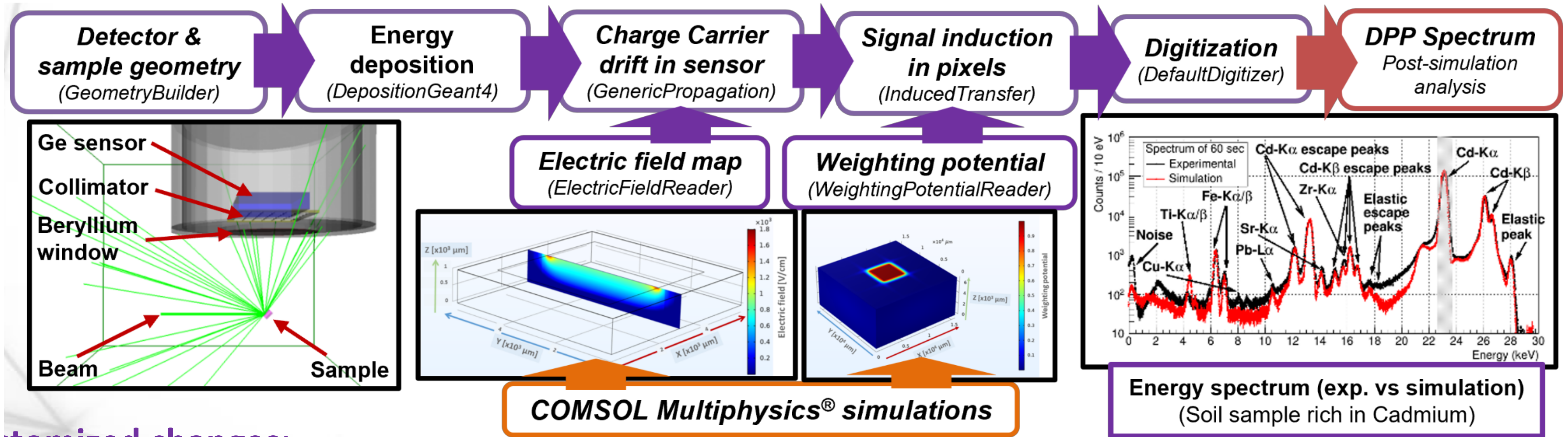

Figure: 8 keV photons spectra.

Figure: of ²⁴¹Am source spectra.



- ✓ The Caughey–Thomas approximation for the low-field carrier mobilities of 4H-SiC was implemented in the Allpix²

$$\mu_{n,p} = \mu_{n,p}^{min} + \frac{\mu_{n,p}^{max} - \mu_{n,p}^{min}}{1 + \left(\frac{N_i}{N_{n,p}^{crit}}\right)^{\delta_{n,p}}}$$

considering the temperature dependence of the parameters, the equation becomes

$$\mu_{n,p} = \mu_{n,p}^{min,0} \left(\frac{T}{300K}\right)^{\alpha_{n,p}} + \frac{\mu_{n,p}^{max,0} \left(\frac{T}{300K}\right)^{\alpha_{n,p}} - \mu_{n,p}^{min,0} \left(\frac{T}{300K}\right)^{\beta_{n,p}}}{1 + \left(\frac{T}{300K}\right)^{\gamma_{n,p}} \left(\frac{N_i}{N_{n,p}^{crit,0}}\right)^{\delta_{n,p}}}$$

Table 1. Caughey–Thomas fit parameters for carrier mobilities in 4H-SiC

Carrier type	$\mu^{min,0}$ cm ² V ⁻¹ s ⁻¹	$\mu^{max,0}$ cm ² V ⁻¹ s ⁻¹	$N^{crit,0}$ cm ⁻³	α	β	γ	δ	Reference
Electrons	40	950	2×10^{17}	-0.5	-2.4	-0.76	0.76	[3]
Holes	15.9	124	1.76×10^{19}	0	-1.8	0.00	0.34	[4]

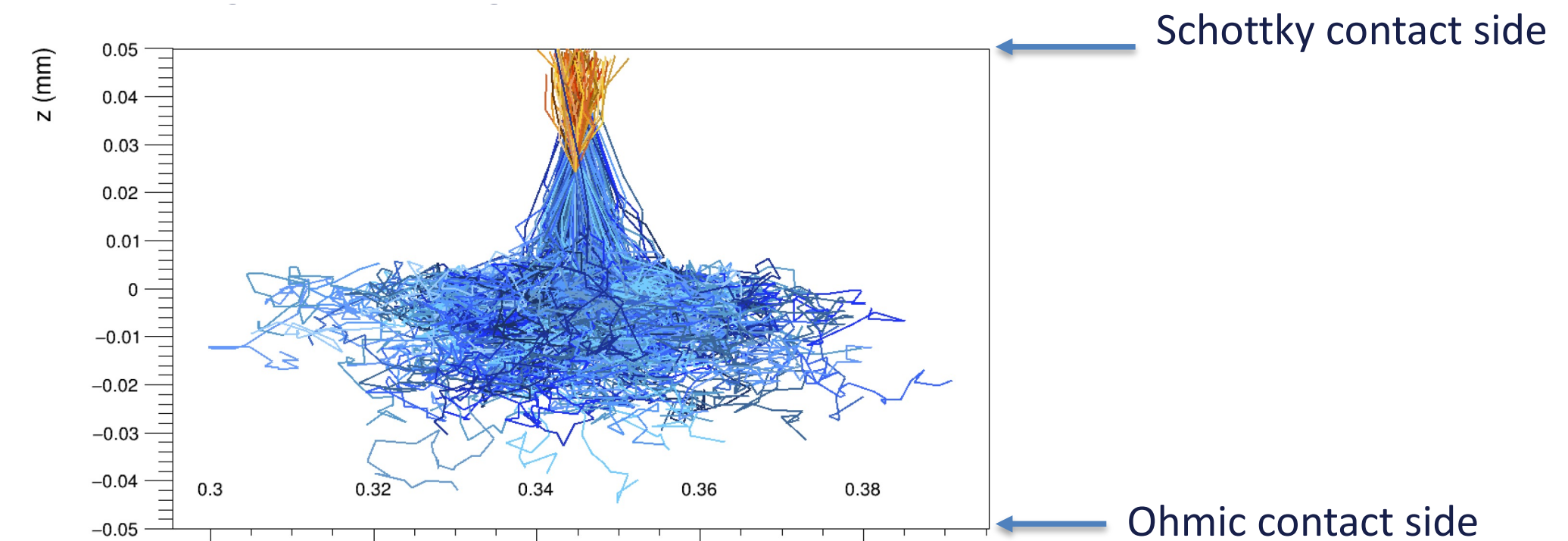
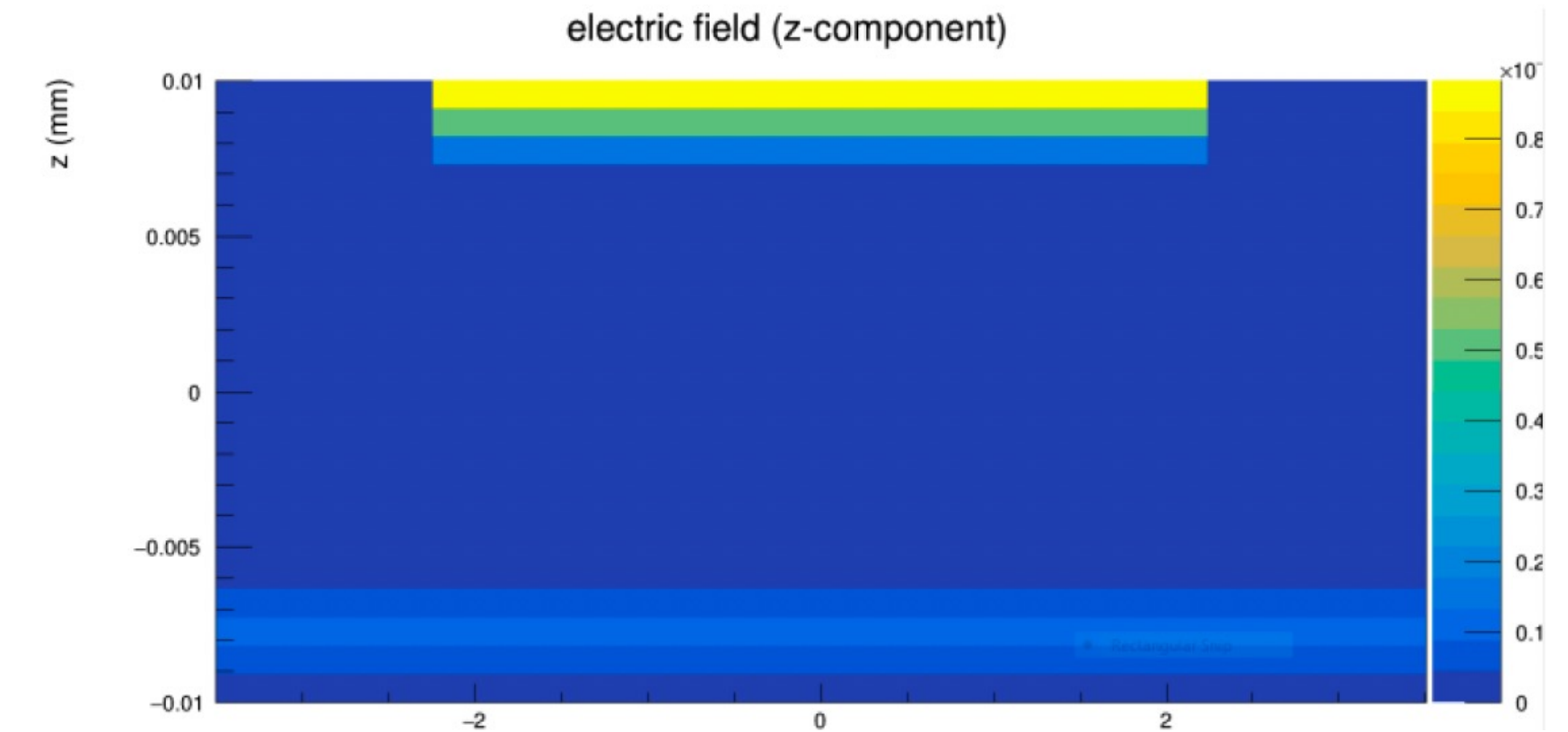

Weird detector geometries

Requirements from different groups have again led to changes in the core to make it flexible enough to cope with different sensor geometries

- This can be in the trivial sense of how the sensor is mapped onto the channel

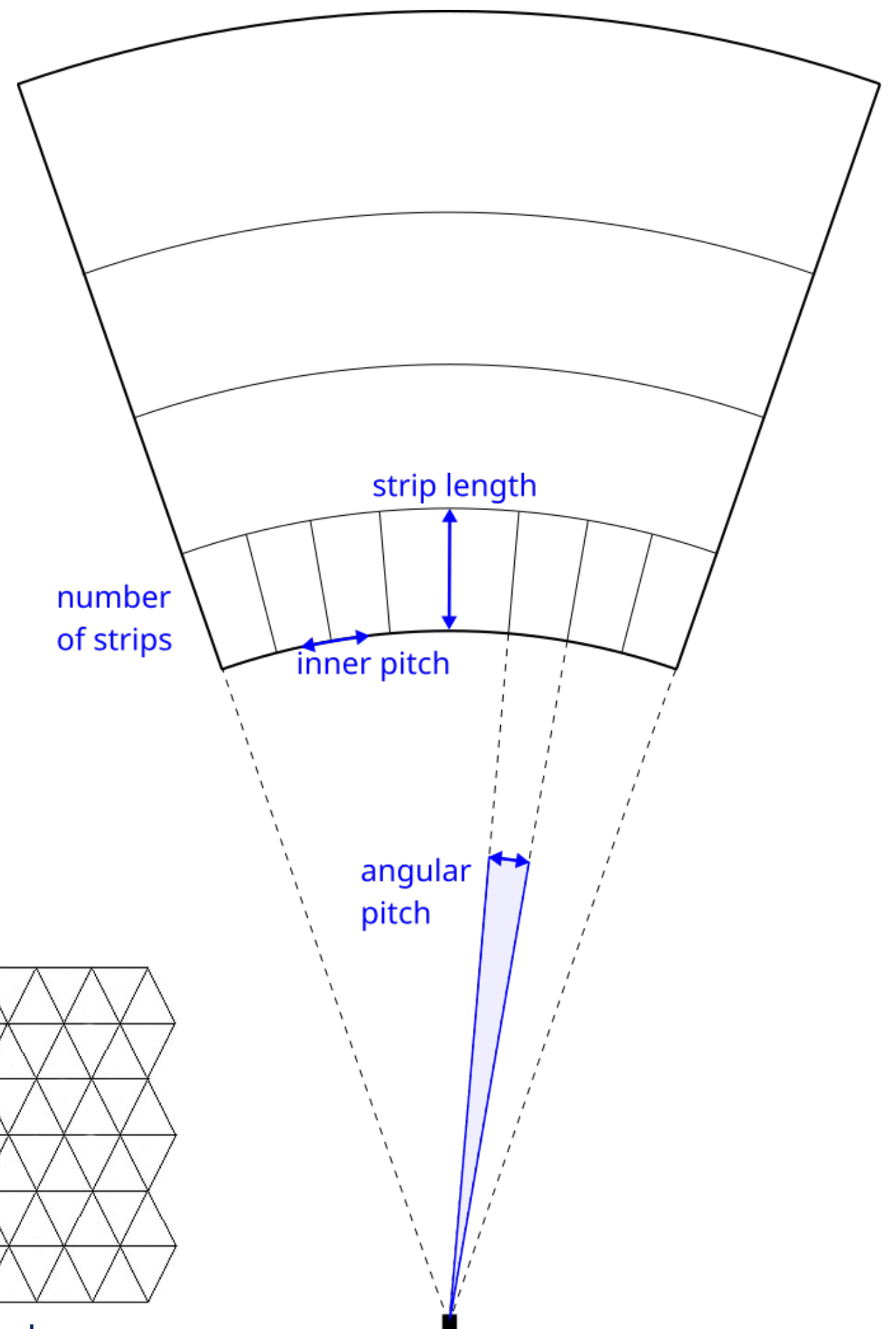
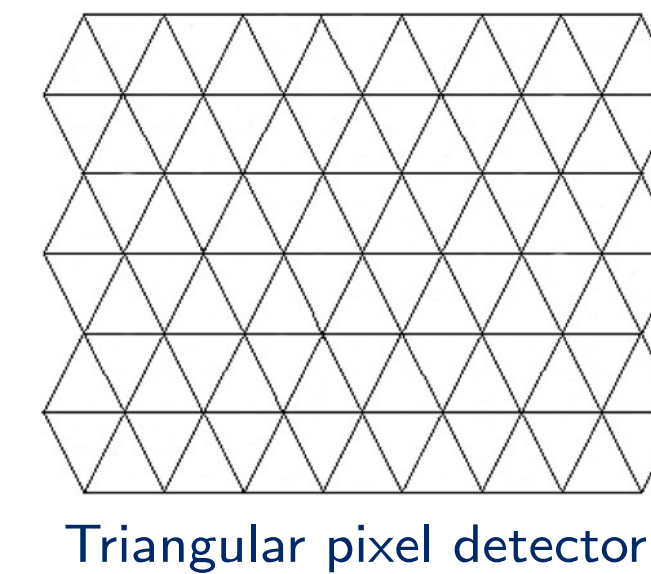
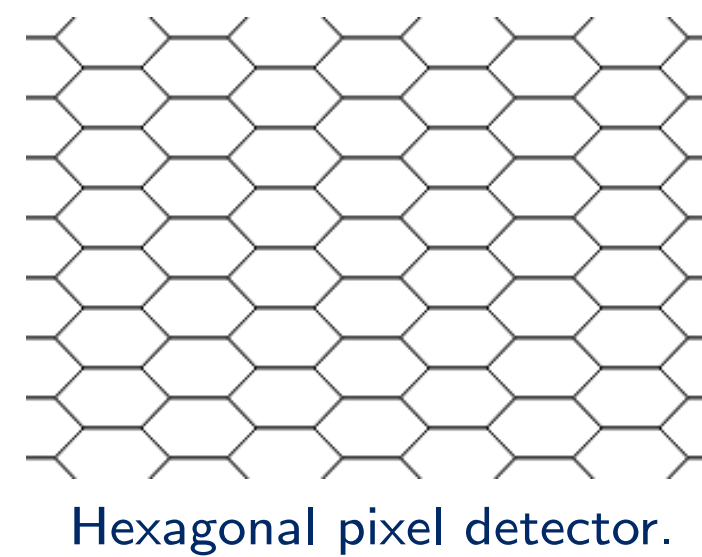
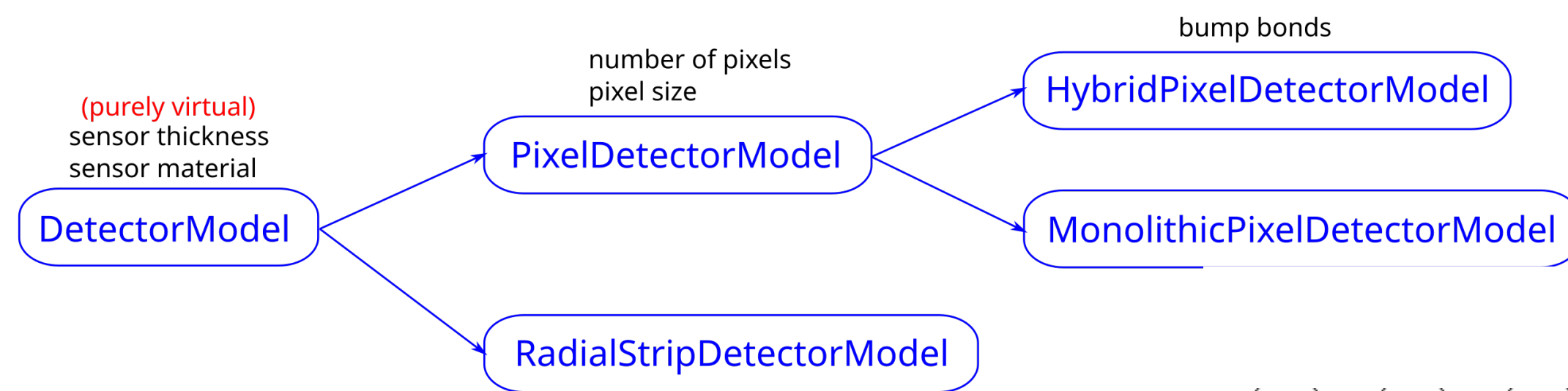

Weird detector geometries

Requirements from different groups have again led to changes in the core to make it flexible enough to cope with different sensor geometries

- This can be in the trivial sense of how the sensor is mapped onto the channel
- Or more complicated implant shapes - cf. 3D!

Carriers drifting

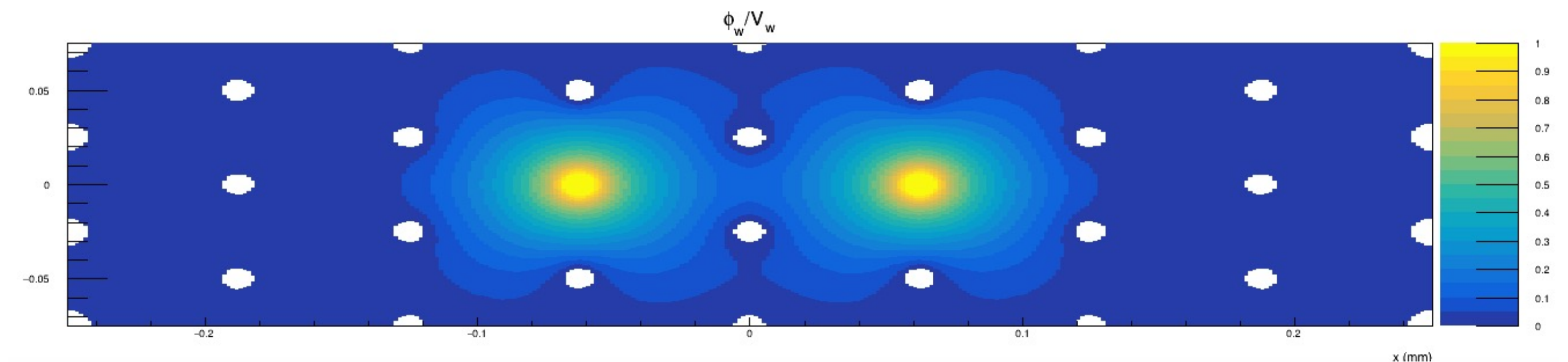
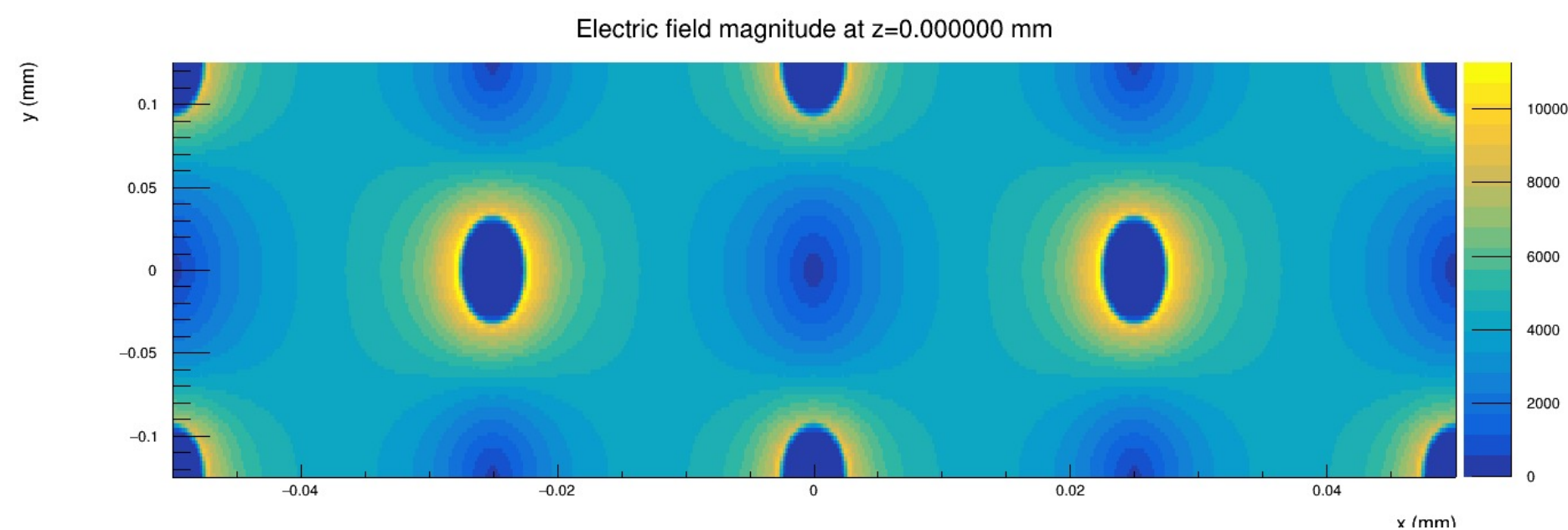
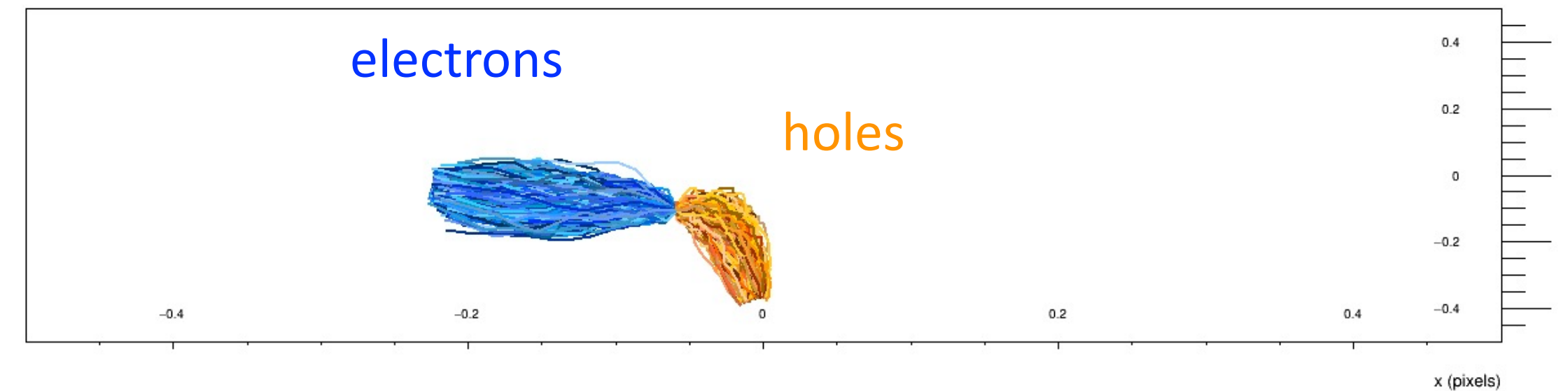

Avalanches in silicon

Ongoing work in addressing one of the popular topics in detector development at the moment: charge multiplication

- Multiple models have been implemented and validation is underway

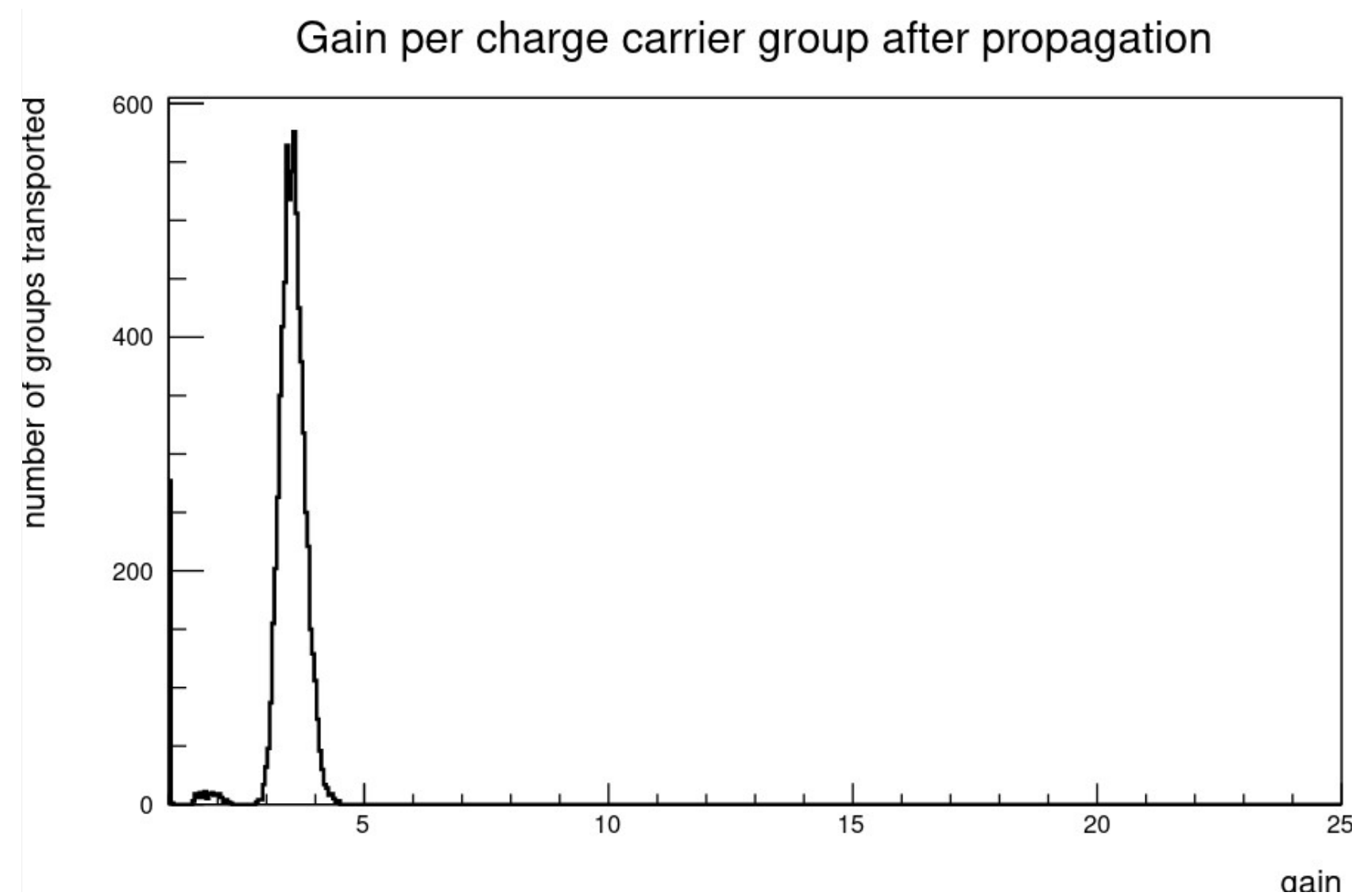

```
[GenericPropagation]
temperature = 293K
multiplication_model = "massey"
multiplication_threshold = 100kV/cm
```

Implementation of charge multiplication through impact ionization underway

- Multiple models available, selection via configuration file:
 - Massey
 - van Overstraeten-de Man
 - Okuto-Crowell
 - Bologna
- Fully documented in user manual
- **Implementation in Allpix² completed**, undergoing testing, Comparison with Weightfield2 & TCAD simulations

Similarly, implementation of radiation damage is required to study devices for hadron collider experiments

- Clearly contains two components:
 - Modified TCAD electric field profile (proper modelling of space charge effects)
 - Charge trapping implementation in allpix²

2016 JINST 11 P04023

Table 1. The key parameter values used in the Synopsys device simulation. These include: donor and acceptor concentrations, N_D and N_A , and their electron and hole capture cross sections, $\sigma_{D,A}^{e,h}$, for silicon sensors after irradiation with 23 GeV protons (top rows) [11], and for sensors after irradiation with 23 MeV protons (bottom rows) [8].

ϕ_{neq} [10^{14} neq/cm ²]	N_A [10^{14} cm ⁻³]	N_D [10^{14} cm ⁻³]	σ_A^e [10^{-15} cm ²]	σ_D^e [10^{-15} cm ²]	σ_A^h [10^{-15} cm ²]	σ_D^h [10^{-15} cm ²]
2 (23 GeV) [11]	6.8	10	6.6	6.6	1.65	6.6
6 (23 GeV) [11]	16	40	6.6	6.6	1.65	1.65
12 (23 GeV) [11, 18] ⁴	30	69	3.8	3.8	0.94	0.94
24 (23 GeV) [11, 18] ⁴	61	138	3.8	3.8	0.94	0.94
5 (23 MeV) [8]	4.2	15	10	10	10	10
10 (23 MeV) [8]	12.5	52	10	10	10	10

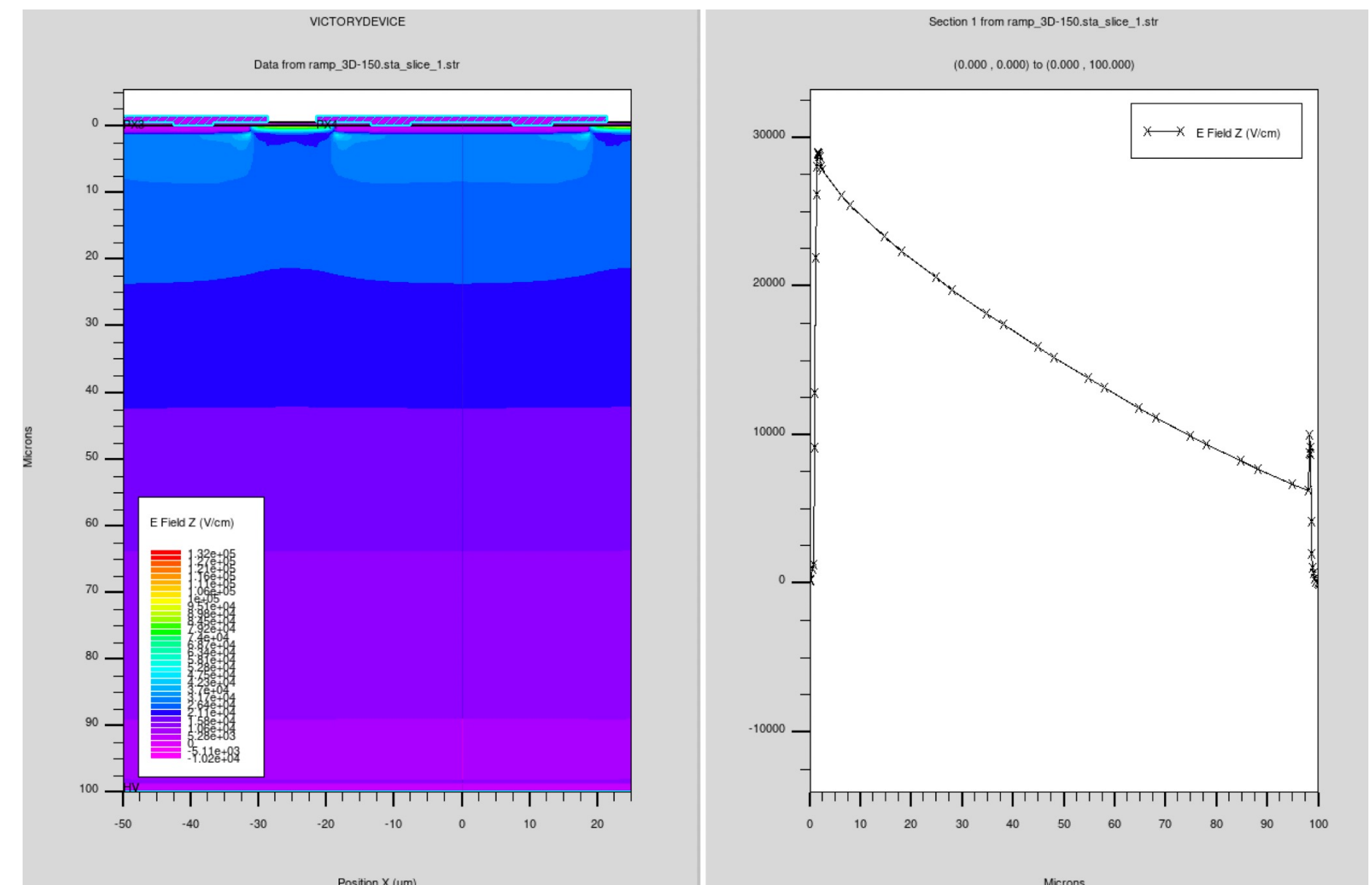

Similarly, implementation of radiation damage is required to study devices for hadron collider experiments

- Clearly contains two components:
 - Modified TCAD electric field profile (proper modelling of space charge effects)
 - Charge trapping implementation in allpix²

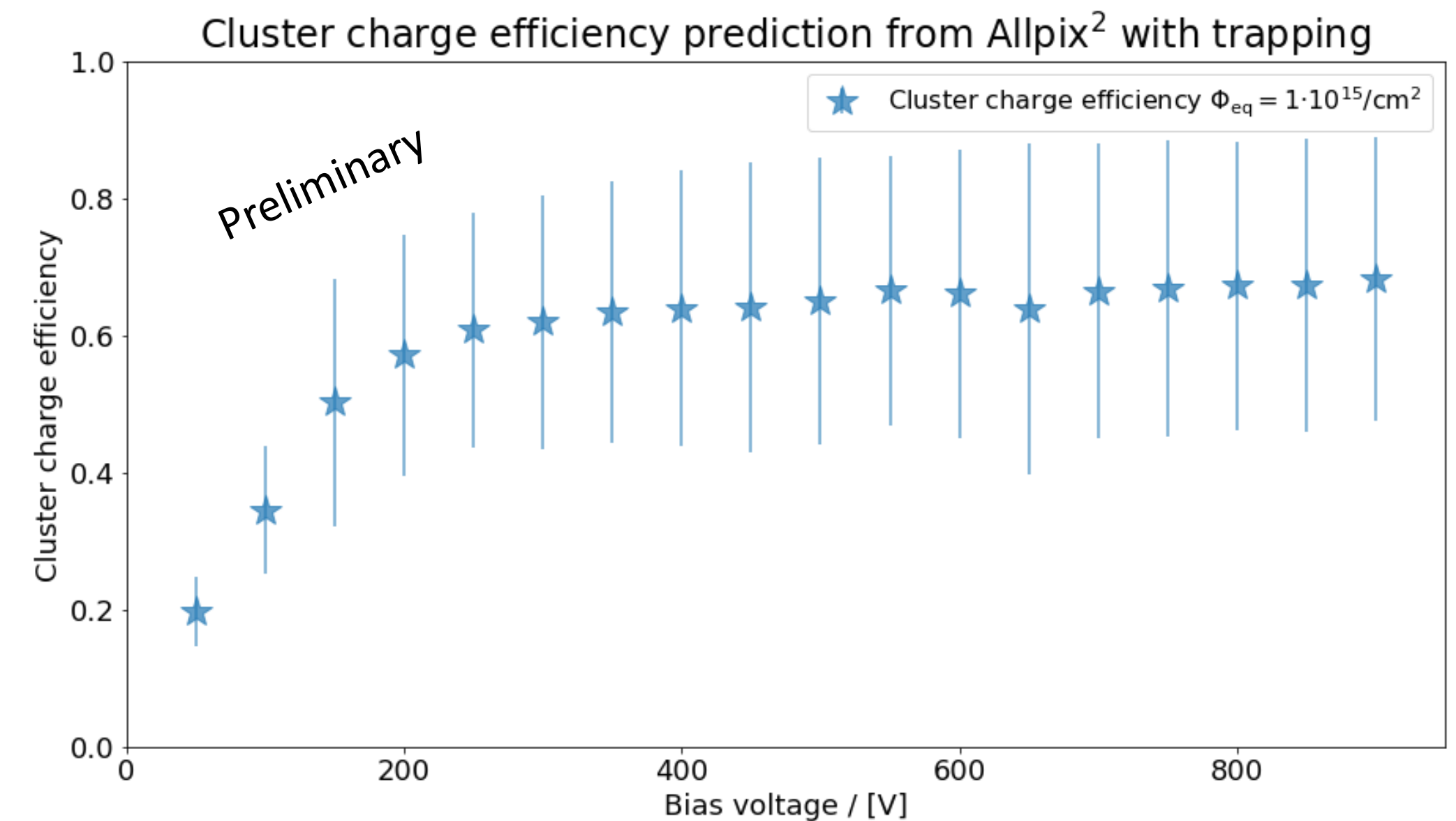
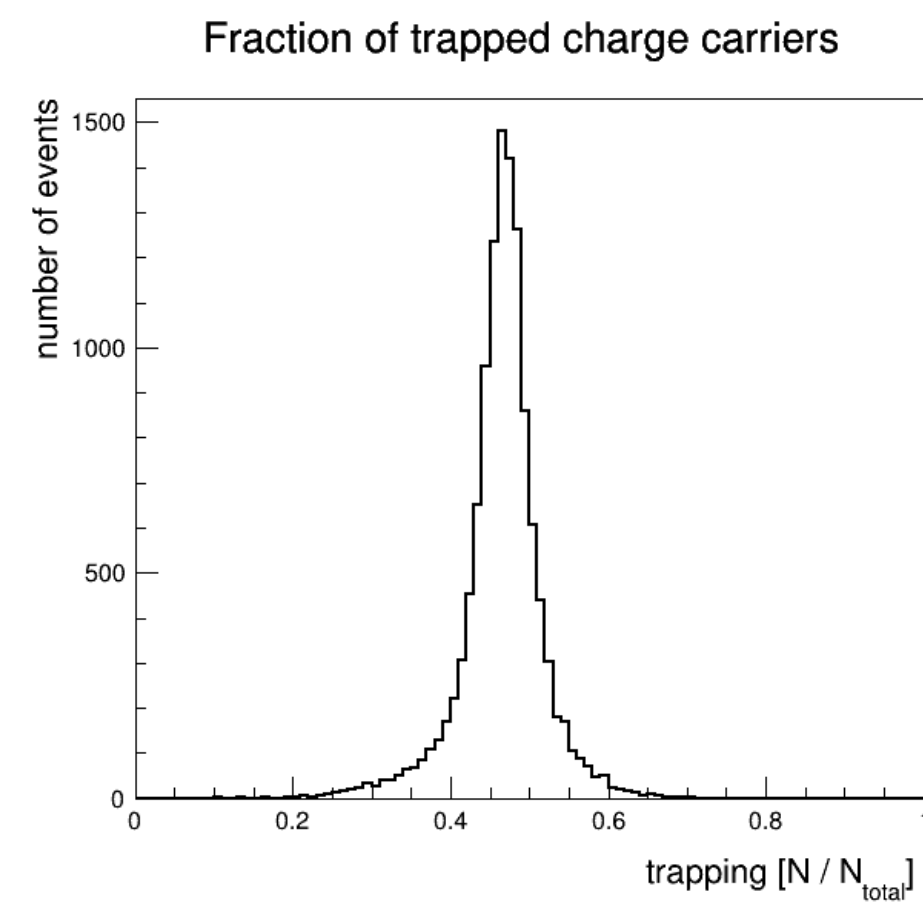
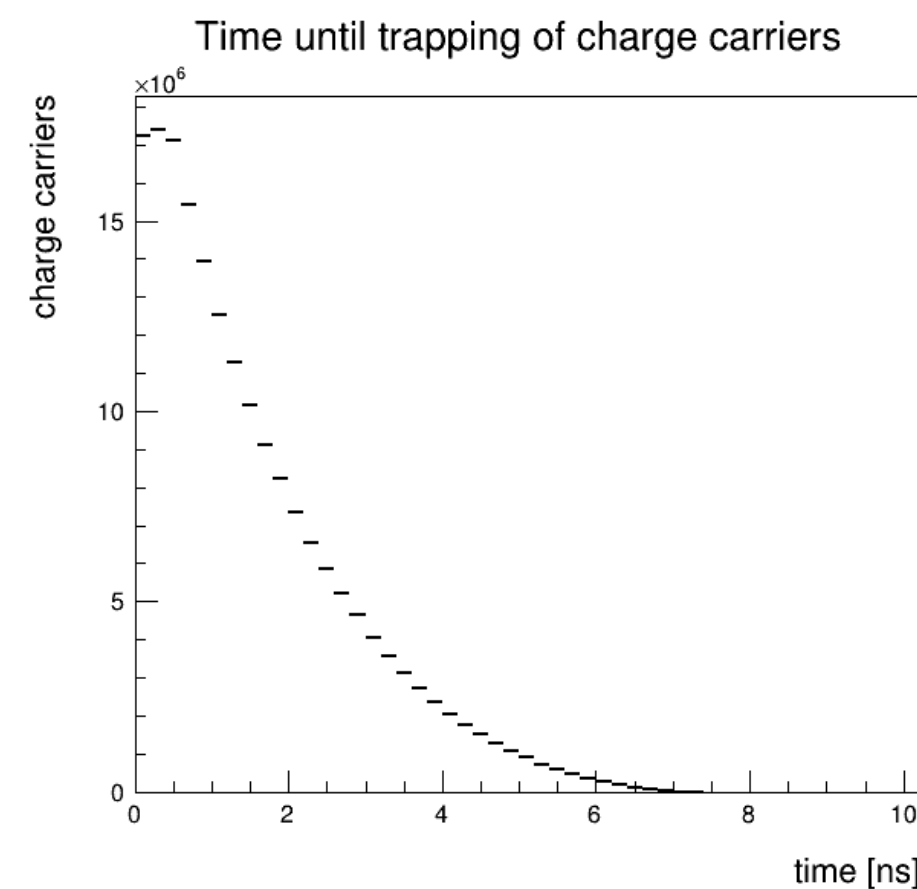

A whole lot more

	Registration		
	Seminar room 4, DESY, Hamburg, Germany		12:30 - 13:00
13:00	Welcome from the workshop organisers	Håkan Wennlöf	13:00 - 13:10
	Seminar room 4, DESY, Hamburg, Germany		
	Overview: Allpix Squared 2.x Releases	Simon Spannagel	13:10 - 13:35
	Seminar room 4, DESY, Hamburg, Germany		
	The 100µPET project: Simulation of the next generation PET scanner with monolithic silicon pixel sensors	Jihad Saidi	13:35 - 14:00
	Seminar room 4, DESY, Hamburg, Germany		
14:00	Development and simulation of a new preshower detector for the FASER experiment at the LHC	Rafaella Eleni Kotitsa	14:00 - 14:25
	Seminar room 4, DESY, Hamburg, Germany		
	Deconvolution of Spectra of High-Flux Mixed Radiation Fields with Dosepix	Mr Florian Beißer	14:25 - 14:50
	Seminar room 4, DESY, Hamburg, Germany		
15:00	Simulation of sapphire micro-strip detectors with Allpix Squared for the LUXE's Gamma Beam Profiler detector	Pietro Grutta	
	Seminar room 4, DESY, Hamburg, Germany		
	Coffee break		15:15 - 15:45
	Seminar room 4, DESY, Hamburg, Germany		
16:00	Simulation of laser-TCT experiments with Allpix²	Daniil Rastorguev	15:45 - 16:10
	Seminar room 4, DESY, Hamburg, Germany		
	Test beam simulations of the ATLAS ITk Strip End-Cap detectors	Radek Privara	16:10 - 16:35
	Seminar room 4, DESY, Hamburg, Germany		
	Simulation of Radial Strips for Comic Ray Studies	Maximilian Caspar	16:35 - 17:00
	Seminar room 4, DESY, Hamburg, Germany		
17:00	Deep learning for sub-micron UCN position resolution using CMOS sensor	Shanny Lin	17:00 - 17:25
	Seminar room 4, DESY, Hamburg, Germany		

	Morning coffee		09:40 - 10:00
	Seminar room 4, DESY, Hamburg, Germany		
10:00	Simulation of hybrid pixels using precise TCAD simulations	Keerthi Nakkalil	10:00 - 10:25
	Seminar room 4, DESY, Hamburg, Germany		
	Simulating monolithic active pixel sensors using generic doping profiles	Adriana Simancas	10:25 - 10:50
	Seminar room 4, DESY, Hamburg, Germany		
11:00	Transient Simulations: Weighting Potentials through Technology Computer-Aided Design	Manuel Alejandro Del Rio Viera	
	Seminar room 4, DESY, Hamburg, Germany		
	Beam Telescope Simulations in Allpix Squared	Sara Ruiz Daza	11:15 - 11:40
	Seminar room 4, DESY, Hamburg, Germany		
	Hexagonal silicon pixel simulations	Håkan Wennlöf	11:40 - 12:05
	Seminar room 4, DESY, Hamburg, Germany		
12:00	Lunch		12:05 - 13:00
	Seminar room 4, DESY, Hamburg, Germany		
13:00	A Timepix3 front-end simulator plugin for Allpix2	Pinelopi Christodoulou	13:00 - 13:25
	Seminar room 4, DESY, Hamburg, Germany		
	Assessing the Impact of Miscalibrating the RD53B-CMS Front End for the HL-LHC CMS Inner Tracker	Andreas Mastronikolis	
	Seminar room 4, DESY, Hamburg, Germany		
14:00	Reconstruction of high track density beams in beam tests	Christopher Krause	13:50 - 14:15
	Seminar room 4, DESY, Hamburg, Germany		
	Time Resolution Simulations for 4H-SiC PiN Detectors	Andreas Gsponer	14:15 - 14:40
	Seminar room 4, DESY, Hamburg, Germany		
	A look to Charge carrier properties in single-crystal diamonds using the Allpix-squared simulation framework	Mr Faiz Ishaqzai	
	Seminar room 4, DESY, Hamburg, Germany		
15:00	Coffee break		15:05 - 15:30
	Seminar room 4, DESY, Hamburg, Germany		
	Allpix Squared Website & Documentation	Stephan Lachnit et al.	15:30 - 15:50
	Seminar room 4, DESY, Hamburg, Germany		
	New features in Allpix Squared 3.0	Paul Schütze	15:50 - 16:15
	Seminar room 4, DESY, Hamburg, Germany		
16:00	Upcoming features and current developments	Paul Schütze et al.	16:15 - 16:35
	Seminar room 4, DESY, Hamburg, Germany		
17:00	Discussion and open questions		16:35 - 18:00
	Seminar room 4, DESY, Hamburg, Germany		
18:00			

4th Allpix² User Workshop

22-23 May 2023
DESY, Hamburg, Germany

New Features
User applications & studies
Software Developments

Organisers:
Håkan Wennlöf
Paul Schütze
Sara Ruiz Daza
Simon Spannagel
Stephan Lachnit

Abstract deadline: **31 March 2023**
Registration deadline: **14 April 2023**

For more information, please scan the QR code or go to: <https://indico.cern.ch/e/apsqws4>

Contact: allpix-squared-workshop@cern.ch

Summary

A lot of functionality has been implemented in allpix², after the initial work to set it up as a platform for semiconductor detector simulations

- A modern and self-contained framework that allows developers to work on solid-state physics

It is straightforward to get up-and-running on cvmfs or with a local installation for development work. The first port of call is always the (extensive) user manual:

- <https://allpix-squared.docs.cern.ch>

Support available via email on the dedicated mailing list, on Mattermost and on the dedicated forum:

- allpix-squared-users@cern.ch
- <https://mattermost.web.cern.ch/allpix2>
- <https://cern.ch/allpix-squared-forum/>

Come and join in person for the allpix squared workshop in 2024 - to be held at the University of Oxford!

