

UK Advanced Instrumentation Training

Circuit Design 3 & 4
Simulation LTspice 1 & 2

Dr Weida Zhang
@physics.ox.ac.uk
2022 Apr 19



Circuit Design, Noise, Grounding

- Workflow
 - Analyze -> Block Diagram, Specs
 - Schematic -> Circuit topology, Constraints
 - Layout -> GERBER, BOM, Assembly-files
 - Manufacturing (fabrication, population, assembly)
 - Debug, Characterization -> Reports
 - (Revision)
- Simulation

Circuit Design, Noise, Grounding

- Workflow
 - Analyze -> Block Diagram, Specs

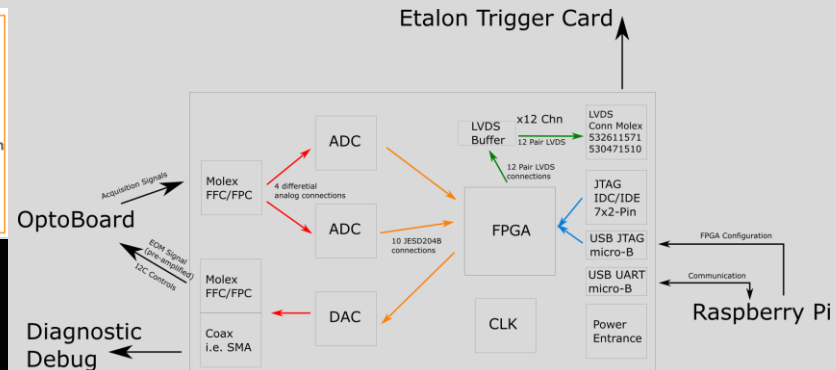
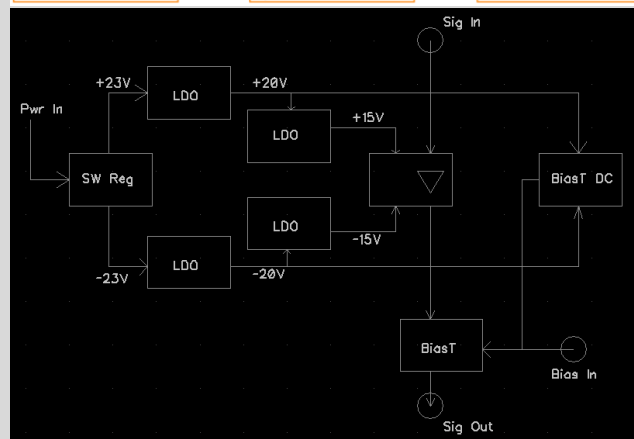
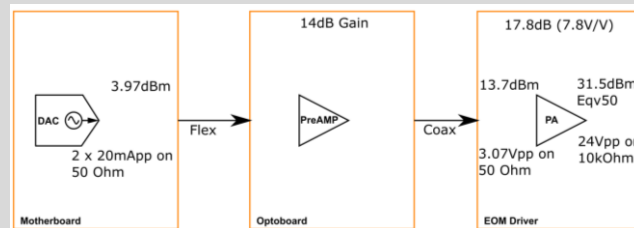

Recalculated Power Consumption at 3.8.9.2:

	Layer	Power Supply Net Name	Voltage (V)	Consumer	Current Input (mA)
ADP2384	1	VDD3V8	3.8	DAC + CLK	454
				Total	454
MAX15301	1	VDD3V3	3.3	LVDS + USB	155
				FPGA Fabric	TBD (Max725)
				DAC + CLK	5.7
				ADC	801
				Total	1686.7
MAX15301	1	VDD1V8	1.8	DAC + CLK	767
				2 ADCs	1572
				FPGA MGT	2983
				FPGA Fabric	2938
				Total	8260
MAX15301	1	VCCINT	0.95	FPGA Fabric	10262
				Total	10262

Circuit Design, Noise, Grounding

- Workflow
 - Schematic -> Circuit topology, Constraints

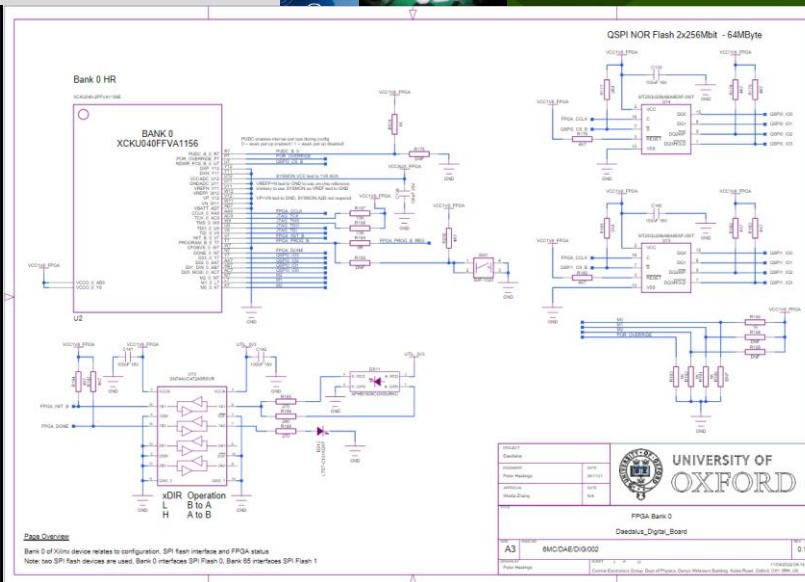
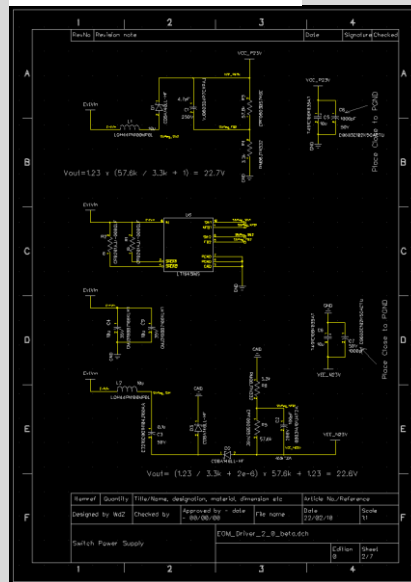
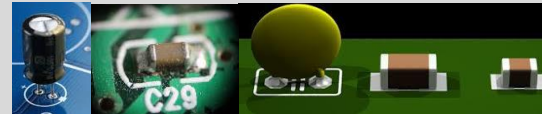
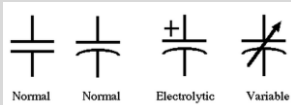

UNIVERSITY OF
OXFORD

FPGA Bank 0
Dedicated_Digital_Base

Part No:	6MCCAE10/002	Rev:	0.1
Part Name:		Issue:	
Part Desc:		Date:	
Part Cat:		Author:	
Part Loc:		Checked:	

Drawn by: [Name]

Circuit Design, Noise, Grounding

- Workflow
 - Layout -> GERBER, BOM, Assembly-files

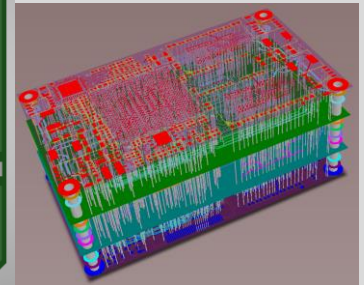
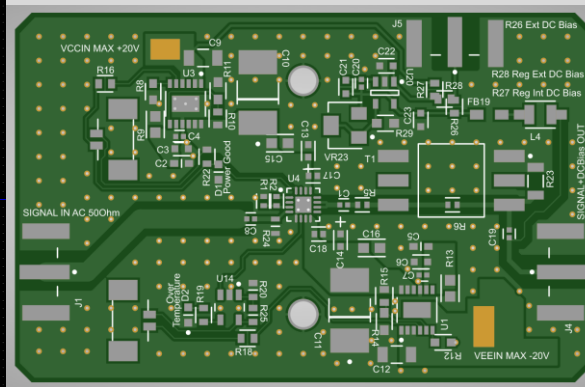
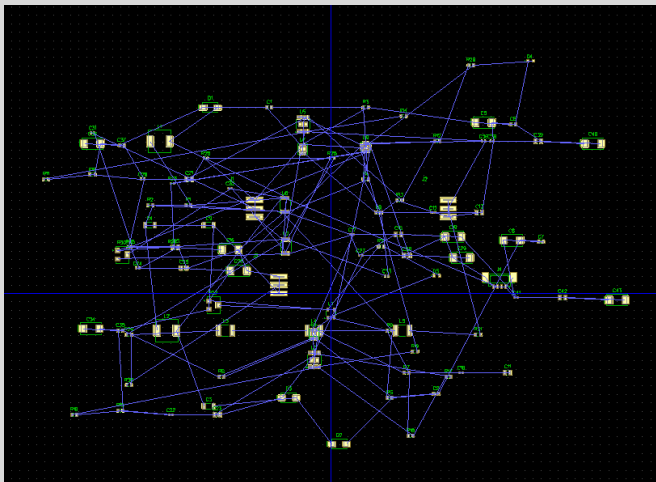

Circuit Design, Noise, Grounding

- Workflow
 - Manufacturing (fabrication, population, assembly)

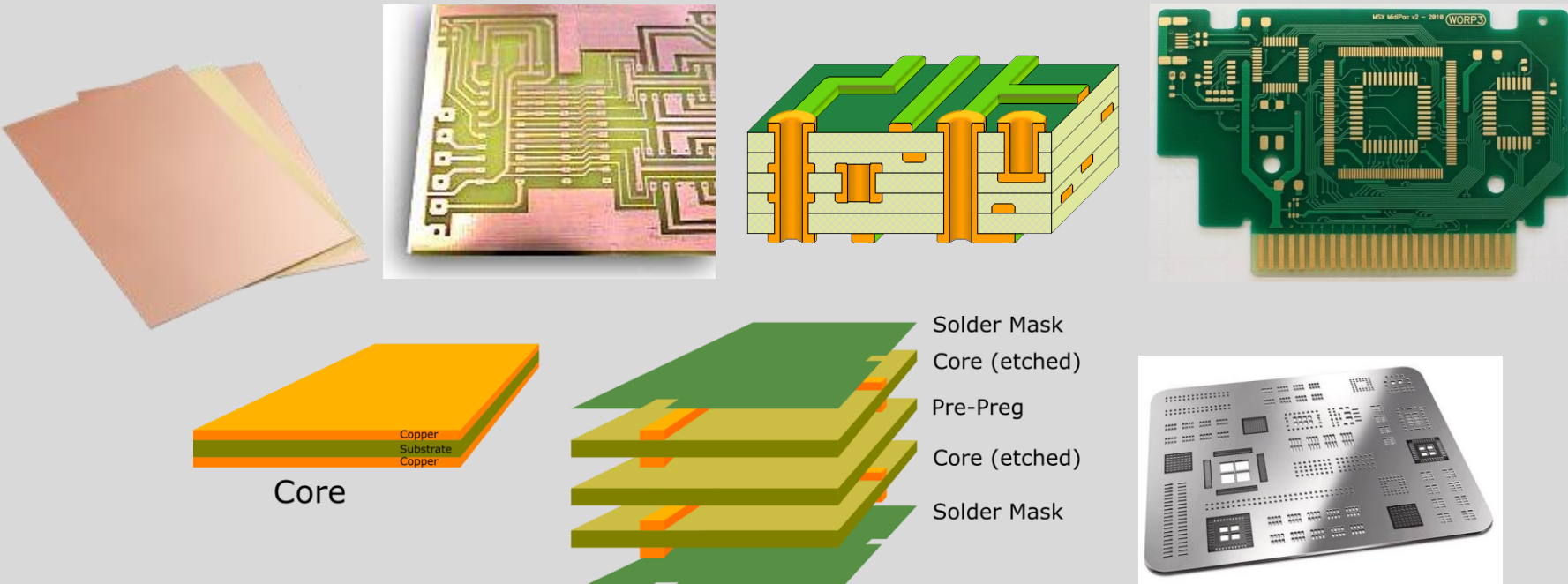

Circuit Design, Noise, Grounding

- Noise
 - Thermal \sim quasi-white, Gaussian, $4kTR$; Conductor
 - Shot \sim white, Gaussian, $2e|I|$; Semiconductor
 - $1/f$, flicker $\sim f$ -depend; Anything
 - Burst ~ 2 -value, f -depend; Semiconductor

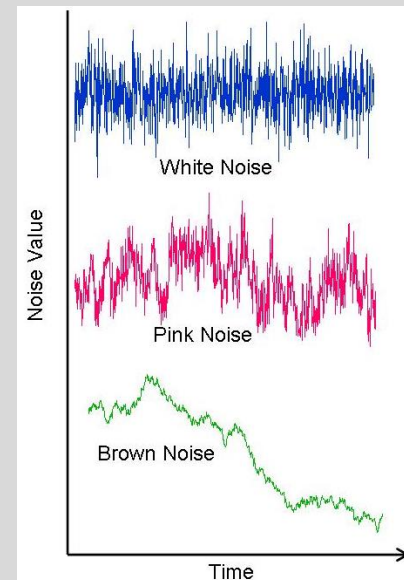
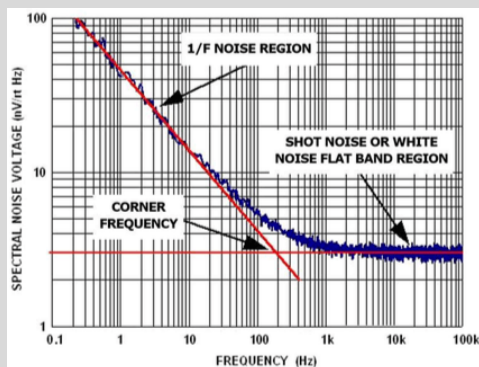

Circuit Design, Noise, Grounding

- Interference/Crosstalk
 - Data/Clock dependent \sim non-stationary, f -depend
- Systematic
 - Harmonics, Spurs $\sim f$ -depend; Amp-linearity, ADC, DAC
 - Quantization Noise \sim quasi-white, uniform; ADC
 - Aliasing/Mirror Noise \sim Signal x Sinc, uniform; ADC, DAC
 - Clock Phase Noise $\sim 1/f^\alpha$; resonant, quartz, PLL

Circuit Design, Noise, Grounding

Harmonics

Spurs/Crosstalk

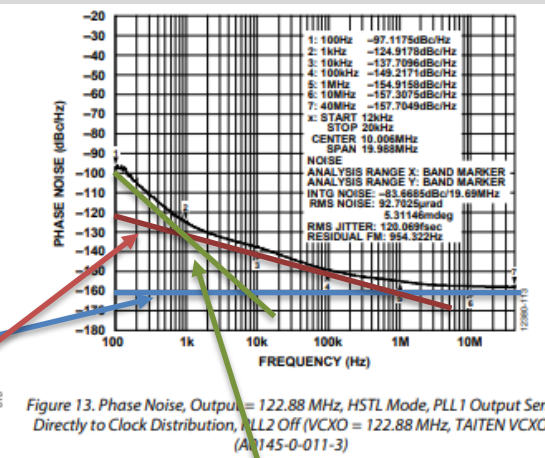
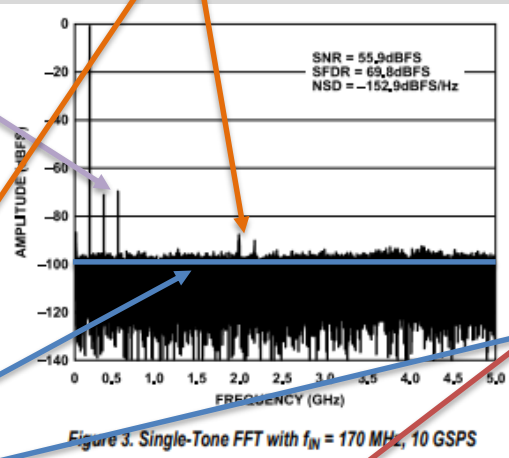
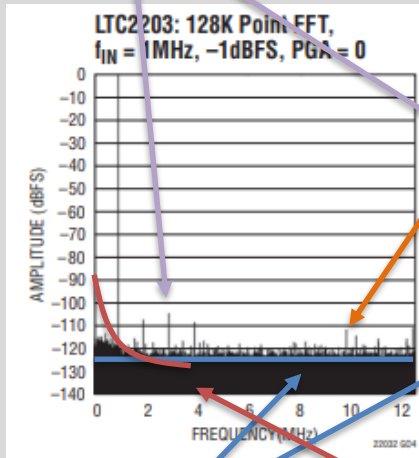

Thermal + Shot + Quantization

$1/f + (\text{Burst})$

$1/f^\alpha$

Circuit Design, Noise, Grounding

- Noise

- Units PSD vs PSD

$$\bar{P} = \lim_{T \rightarrow \infty} \frac{1}{T} \int_{-T/2}^{T/2} \frac{x^2(t)}{R} dt$$

x is the random variable of noise, with the unit of voltage
 Resistivity R is sometimes ignored to 1, \bar{P} is average power

$$\bar{P} = \int_0^B S_x(f) df$$

B is the bandwidth, S_x is the power spectrum density,
 with the unit of Power per Bandwidth, i.e. dBm/Hz

$$x_{\text{RMS}} = \sqrt{\bar{P}R}$$

x_{RMS} is the root-mean-square of the noise, with the unit
 of voltage

$$v_n(f) = \sqrt{S_x(f)R} = \sqrt{\frac{\bar{x}^2}{RB}}$$

This is only in white noise, $v_n(f)$ is the voltage
 spectrum density, with the unit of $V/\sqrt{\text{Hz}}$

Circuit Design, Noise, Grounding

- Noise

- Conversion

- $0\text{dBm} = 0.632V_{\text{PP}} = 0.233 V_{\text{RMS}}$

- Quantify and Comparison

$$x_{\text{RMS}} = \sqrt{\bar{P}R}$$

$$v_n(f) = \sqrt{S_x(f)R} = \sqrt{\frac{\bar{x}^2}{RB}}$$

ADA4099-1/ADA4099-2

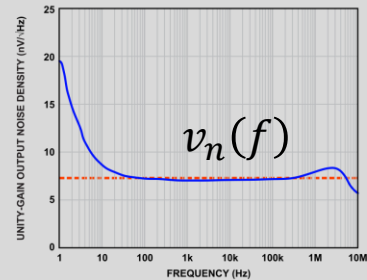

Figure 42. Unity-Gain Output Noise Density vs. Frequency

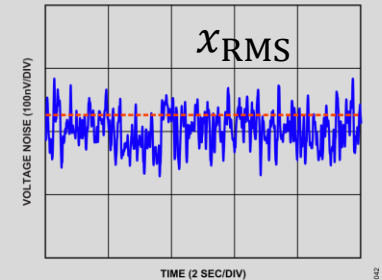

Figure 43. 0.1 Hz to 10 Hz Noise

analog.com

- v_n as a number gives floor
- x_{RMS} at low frequency tells flicker

NOISE PERFORMANCE				
Input Voltage Noise	f = 0.1 Hz to 10 Hz	150	150	nV p-p
	1/f noise corner	6	6	Hz
Over-The-Top	f = 100 Hz	7	7	nV/√Hz
	f = 100 Hz, $V_{\text{CM}} > +V_S$	8	8	nV/√Hz
Input Current Noise	f = 100 Hz	0.5	0.5	pA/√Hz
	Over-The-Top	f = 100 Hz, $V_{\text{CM}} > +V_S$	5	5

Circuit Design, Noise, Grounding

- Noise
 - Paths
 - Signal Input
 - Resistive Components
 - Semiconductor Devices
 - Non-Linear (not LTI)
 - Power Supplies
 - Indirect Coupling

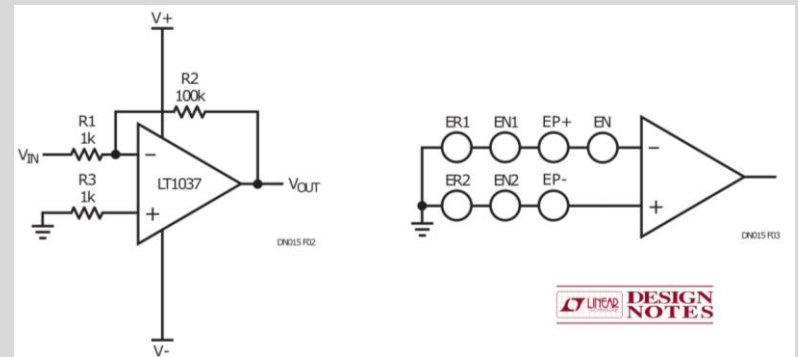

Circuit Design, Noise, Grounding

- Noise

- Paths

- Signal Input

- Antenna, transducer

-> matching network

- Previous Stage of Amps

-> termination

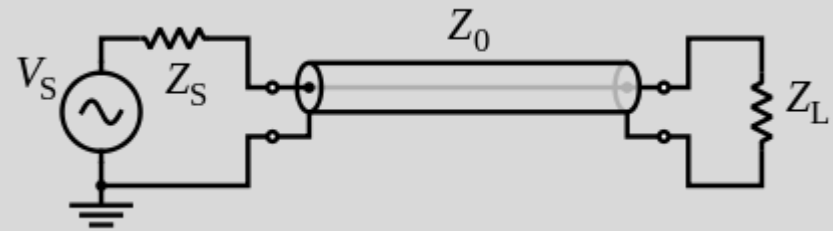

Source: Texas Instruments

$$F_n = F_1 + \frac{F_2 - 1}{G_1} + \frac{F_3 - 1}{G_1 G_2} + \dots$$

Circuit Design, Noise, Grounding

- Noise
 - Paths
 - Signal Input
 - ADC
 - Quantization ENOB
 - Aliasing

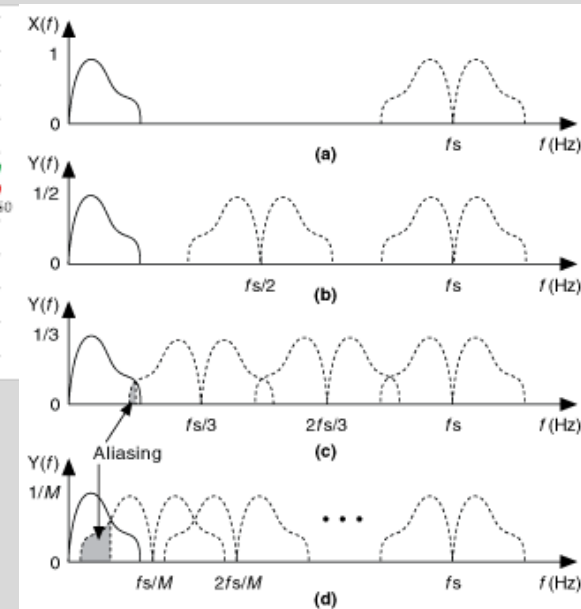
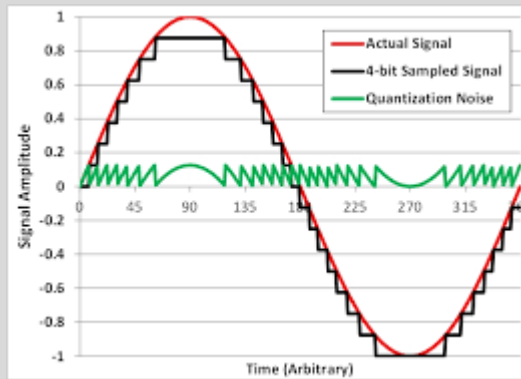

$$x[n] = \sum_n \int s(t) \delta(t - nT_s) dt$$

Circuit Design, Noise, Grounding

- Noise
 - Paths
 - Signal Input
 - DAC
 - Quantization ENOB
 - Mirror/Image

$$s(t) = \sum_n x[n] * \text{rect}\left(\frac{t}{T_S}\right)$$

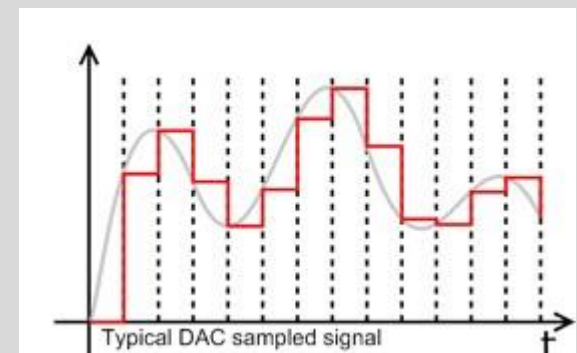
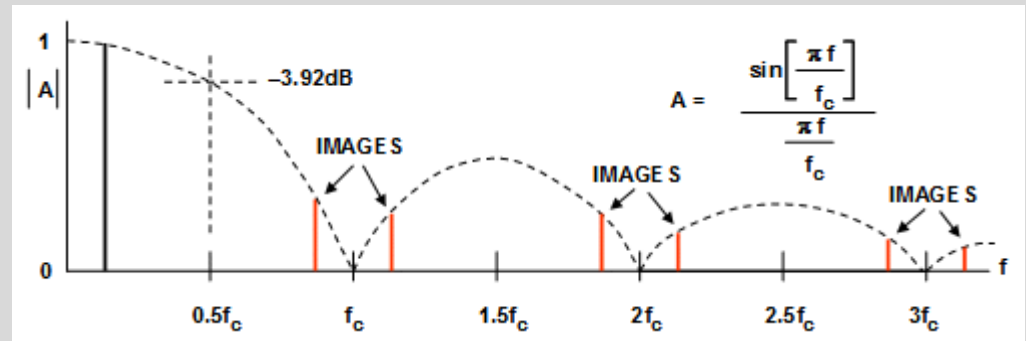

Circuit Design, Noise, Grounding

- Noise
 - Paths
 - Resistive Components
 - Semiconductor Devices

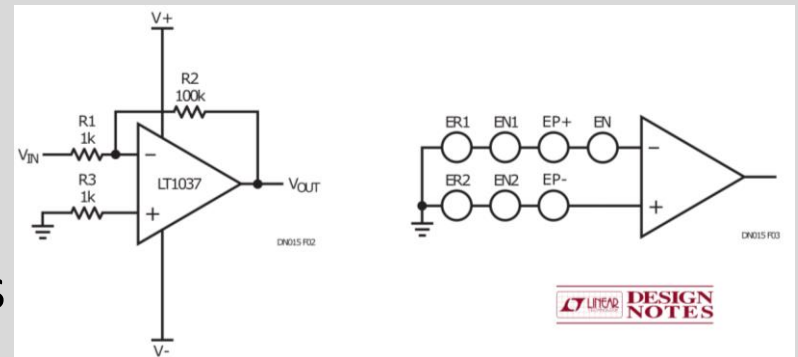

Circuit Design, Noise, Grounding

- Noise
 - Paths
 - Non-Linear (not LTI)

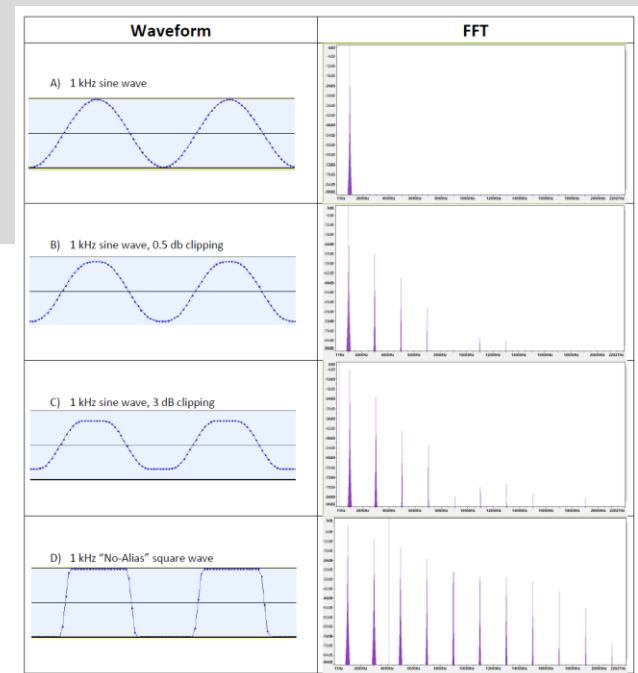
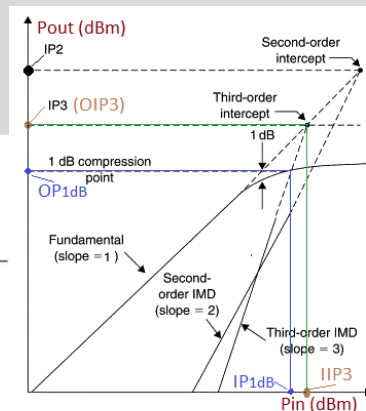
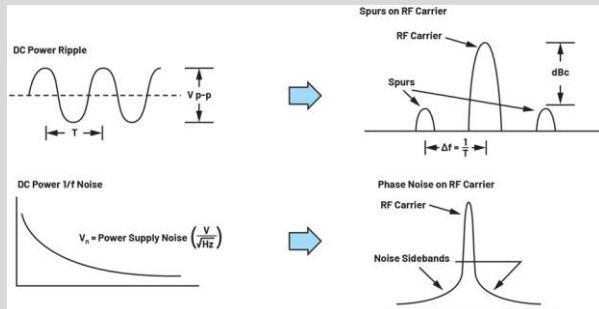

Circuit Design, Noise, Grounding

- Noise
 - Paths
 - Power Supplies
 - Indirect Coupling
 - Power integrity

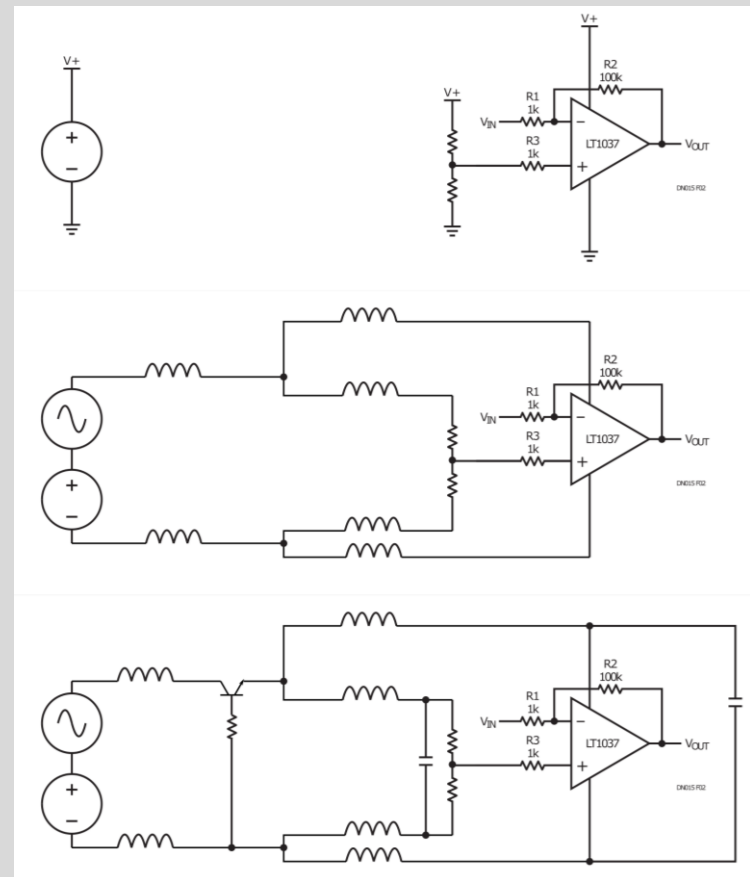

Circuit Design, Noise, Grounding

- Noise
 - Paths
 - Power Supplies
 - Indirect Coupling

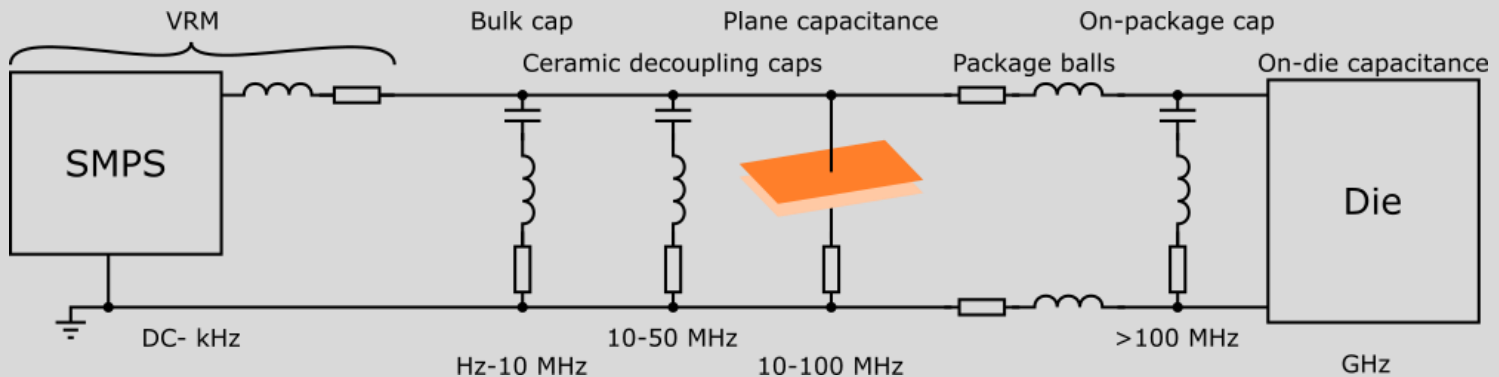
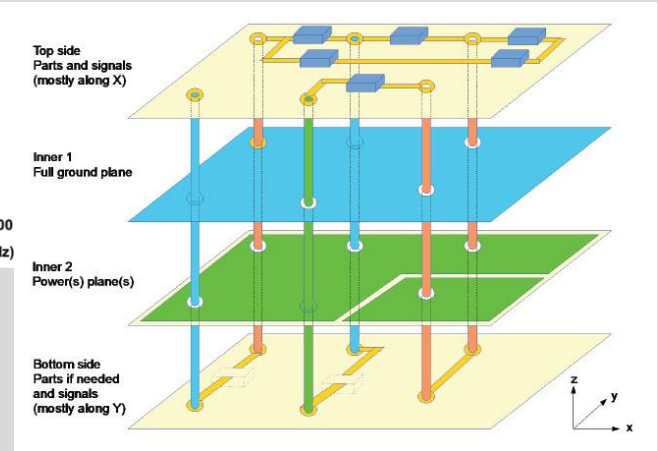
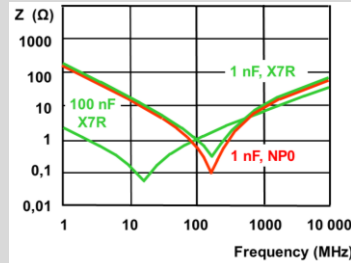

Circuit Design, Noise, Grounding

- Grounding

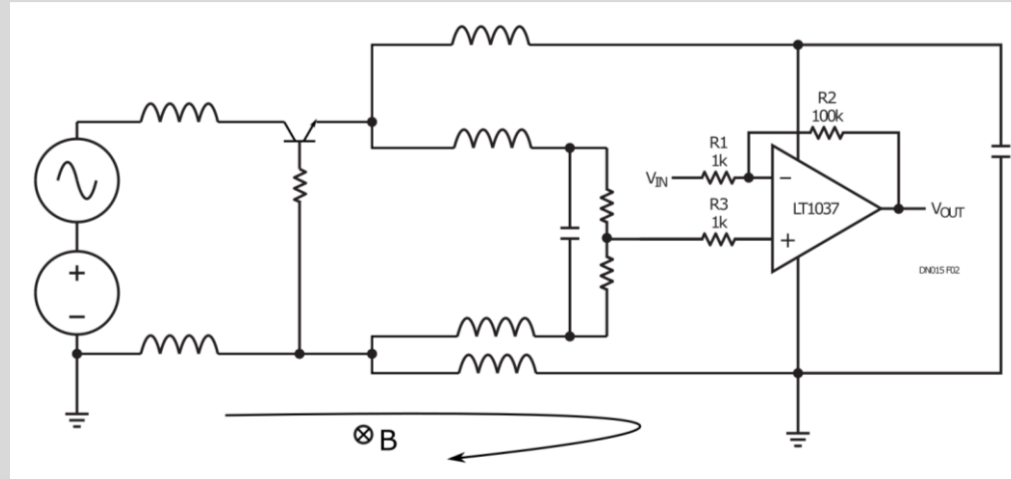

Circuit Design, Amplifier, Clock

- Transmission Line Theory

$$v(z,t) = L\Delta z \frac{\partial i(z,t)}{\partial t} + v(z + \Delta z,t)$$

$$i(z,t) = C\Delta z \frac{\partial v(z + \Delta z,t)}{\partial t} + i(z + \Delta z,t)$$

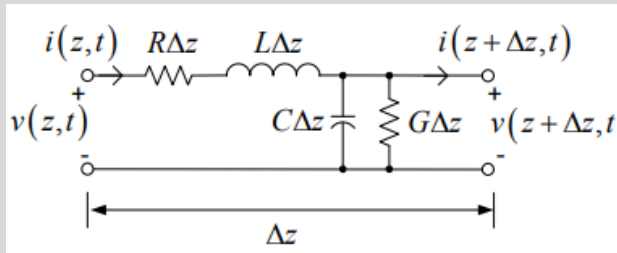

$$\frac{\partial v(z,t)}{\partial z} = -L \frac{\partial i(z,t)}{\partial t}$$

$$\frac{\partial i(z,t)}{\partial z} = -C \frac{\partial v(z,t)}{\partial t}$$

$$\frac{\partial^2 V}{\partial t^2} - u^2 \frac{\partial^2 V}{\partial x^2} = 0$$

$$\frac{\partial^2 I}{\partial t^2} - u^2 \frac{\partial^2 I}{\partial x^2} = 0$$

$$u = \frac{1}{\sqrt{LC}}$$

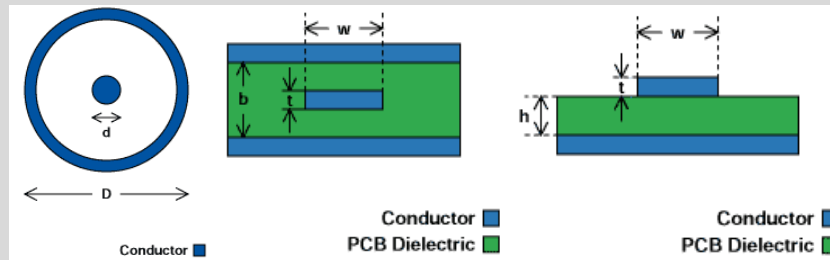

$$V(x) = V_1 e^{-jkx} + V_2 e^{+jkx}$$

$$I(x) = \frac{V_1}{Z_0} e^{-jkx} - \frac{V_2}{Z_0} e^{+jkx}$$

$$Z_0 = \sqrt{\frac{L}{C}}$$

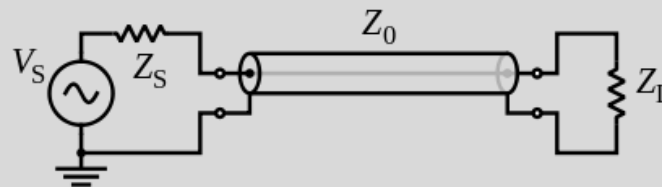

Circuit Design, Amplifier, Clock

- Signal Integrity
 - Designing and Maintaining Trace Structure
 - Termination

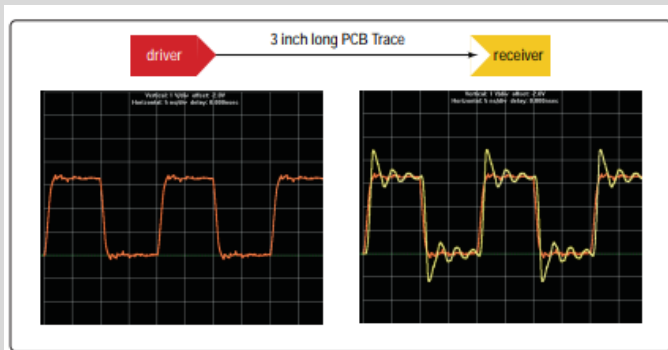
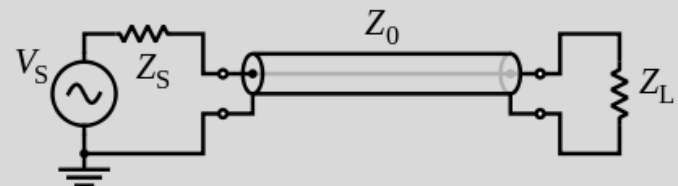
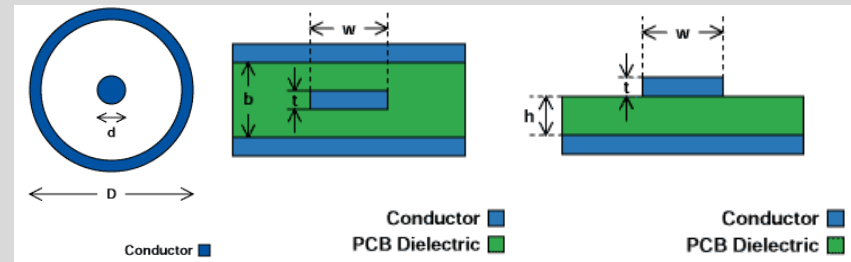

Figure 1. A signal as it emerges from the driver chip (left) is distorted by multiple reflections from impedance discontinuities at both ends (right).

Source: Keysight



Circuit Design, Amplifier, Clock

- Scattering Parameter (S-Parameter)



$$\begin{pmatrix} b_1 \\ b_2 \end{pmatrix} = \begin{pmatrix} S_{11} & S_{12} \\ S_{21} & S_{22} \end{pmatrix} \begin{pmatrix} a_1 \\ a_2 \end{pmatrix}$$

S_{11} is the input port voltage reflection coefficient
 S_{12} is the reverse voltage gain
 S_{21} is the forward voltage gain
 S_{22} is the output port voltage reflection coefficient.

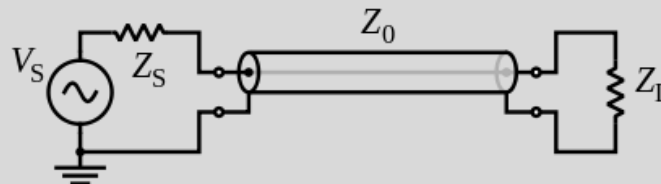

Circuit Design, Amplifier, Clock

- Scattering Parameter (S-Parameter)

CMA-81+
SMT Gain Block, DC - 6000 MHz, 50Ω



Generic photo used for illustration purposes only

- Ceramic, hermetically sealed nitrogen filled
- Low profile case, 0.045" height
- High IP3, +38 dBm

RoHS 

Data, Drawings & Downloads

- DATASHEET
- View Data
- View Graphs
- S-PARAMETERS

```

1 |Mini-Circuits Laboratory
2 |Date: 11/3/2015 at 1:45:13 PM
3 |S2P DATA File Format
4 |Type: MMIC Amplifier
5 |Model: CMA-81+
6 |S/N: Unit 1
7 |Fixture: TB-829-81+ NO PORT EXTENSION.
8 |PIN OUT: PORT 1 - PIN 2, PORT 2 - PIN 7, GROUND - 1,3,4,5,6,8,Bottom Center Paddle
9 |TEST CONDITIONS: Temp= +85 (Deg C) RF Power= +25.00 (dBm) V limit=5(V) I limit=250(mA) Z=50 OHM
10 |WAFER/LOT#: n/a DATE CODE: 1448
11 |Network Analyzer: PNA-X N5242A S/N 71484 CAL DUE: 12/11/2015
12 |P.Supply/Multimeter: HP E3632A S/N 63249 CAL DUE: 12/11/2015
13 |
14 # Hz S dB R 50
15 |Frequency S11 dB S11 Deg S21 dB S21 Deg S12 dB S12 Deg S22 dB S22 Deg
16 10000000 -44.3357200 -166.7859000 10.5643500 179.1727000 -20.4733800 -0.4232950 -20.3147700 0.1972064
17 15000000 -38.1764500 -83.7452500 10.5889700 179.9357000 -20.4535600 0.2922311 -19.5530300 -5.7504110
18 20000000 -42.6544600 167.7492000 10.5664400 178.6488000 -20.4699600 -0.9079536 -20.3498200 -0.6635373
19 25000000 -39.2277800 159.5075000 10.5462600 178.0562000 -20.5083920 -1.2963140 -20.7143700 0.4261140
20 30000000 -43.5065400 178.5663000 10.5655900 177.9172000 -20.4823700 -1.2938770 -20.4270900 -1.7378030
21 35000000 -45.7234300 -162.4352000 10.5566000 177.6096000 -20.5957600 -1.3303600 -20.3532100 -2.6354570
22 40000000 -42.7495200 -168.8238000 10.5670200 177.2186000 -20.4884000 -1.6336710 -20.4072700 -2.9222600
23 45000000 -41.7412000 -172.4569000 10.5645000 176.8549000 -20.4867100 -1.8795270 -20.5594500 -3.3060280
24 50000000 -41.7112100 -172.0631000 10.5706900 176.5308000 -20.4854800 -2.0976540 -20.5895600 -3.8508110
25 55000000 -40.9887200 -171.4034000 10.5617000 176.2349000 -20.4676900 -2.6154540 -20.5889600 -5.0186350
26 60000000 -40.5970600 -173.2739000 10.5600300 175.9174000 -20.4700600 -2.8611950 -20.6548000 -5.5687010
27 65000000 -40.4775000 -173.6170000 10.5591500 175.5924000 -20.4693900 -3.0714600 -20.7066200 -5.9090000
28 70000000 -39.8875100 -168.1615000 10.5574100 175.2423000 -20.4658900 -3.3031110 -20.7705300 -6.6780670
29 75000000 -39.6015700 -166.5091000 10.5573000 174.9256000 -20.4715600 -3.5408440 -20.8229700 -7.4156110
    
```

HMC1049LP5E

Global pHEMT MMIC Low Noise Amplifier, 0.3 - 20 GHz

Overview Evaluation Kits Documentation Tools & Simulations Reference Materials Design Resources

View All Data Sheets (2)

Data Sheet Rev. 8

S-Parameters

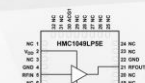

```

1 |Agilent Technologies, E8361A, UC43140893, A.06.04.32
2 |
3 |Date: Wednesday, November 18, 2012 13:50:33
4 |Correction: S11(Full 2 Port(1,2)) S21(Full 2 Port(1,2)) S12(Full 2 Port(1,2)) S22(Full 2 Port(1,2))
5 |S2P File: Measurements: S11, S21, S12, S22:
6 # GHz S dB R 50
7 0.01 -2.404 -11.185 19.791 170.825 -39.68 70.612 -12.811 177.269
8 0.10998 -9.163 -64.832 17.03 156.889 -28.235 13.797 -7.916 172.448
9 0.20996 -13.177 -62.163 16.620 148.303 -27.393 -9.018 -7.766 155.6
10 0.30994 -15.535 -93.74 16.519 137.192 -27.165 -25.482 -7.761 141.733
11 0.40992 -16.953 -105.416 16.465 125.605 -27.073 -39.5 -7.745 128.004
12 0.5099 -18.051 -119.821 16.497 113.637 -26.972 -52.631 -7.773 114.765
13 0.60988 -18.887 -128.091 16.337 100.94 -27.044 -65.903 -7.571 102.589
14 0.70986 -18.973 -143.089 16.306 89.493 -27.005 -77.713 -7.52 89.117
15 0.80984 -19.327 -158.168 16.297 77.6 -26.937 -89.845 -7.5 76.342
16 0.90982 -19.671 -174.056 16.298 65.561 -26.856 -101.935 -7.501 63.655
17 1.0098 -19.878 169.391 16.314 53.504 -26.791 -114.001 -7.489 51.036
18 1.10978 -20.069 153.053 16.356 41.451 -26.714 -126.062 -7.486 38.615
19 1.20976 -20.33 136.8 16.407 29.389 -26.636 -138.179 -7.538 26.456
20 1.30974 -20.619 121.384 16.457 17.241 -26.558 -150.476 -7.538 14.6
21 1.40972 -20.975 106.042 16.538 4.789 -26.486 -162.915 -7.631 2.946
22 1.5097 -21.196 92.108 16.639 -8.001 -26.44 -175.463 -7.745 -8.515
23 1.60968 -21.502 79.294 16.714 -20.955 -26.413 171.873 -7.848 -19.713
24 1.70966 -21.715 69.223 16.751 -35.999 -26.443 159.341 -7.921 -30.536
25 1.80962 -21.544 60.676 16.727 -47.11 -26.508 147.074 -7.946 -41.117
26 1.90962 -20.897 51.647 16.659 -60.31 -26.576 135.068 -7.924 -51.671
27 2.0096 -19.986 40.849 16.587 -73.361 -26.624 123.303 -7.899 -62.406
28 2.10958 -19.116 29.105 16.508 -86.045 -26.645 111.609 -7.877 -73.466
29 2.20956 -18.243 16.012 16.408 -98.481 -26.617 100.072 -7.851 -84.998
    
```

Circuit Design, Amplifier, Clock

- Matching Network

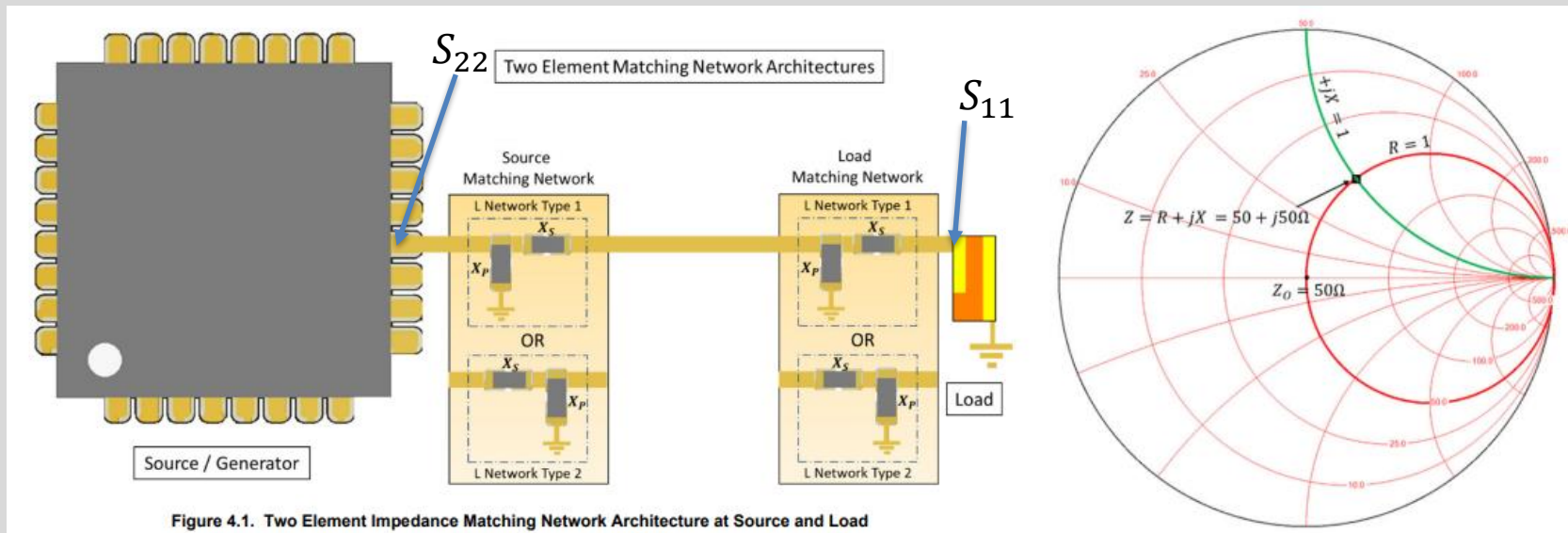

Source: SiLabs

Circuit Design, Amplifier, Clock

- Simulation of Amplifier Design

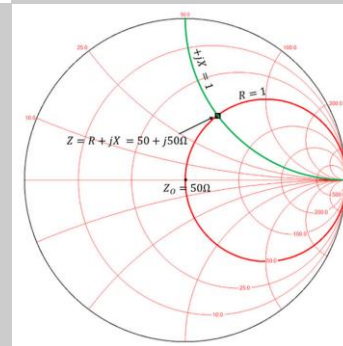
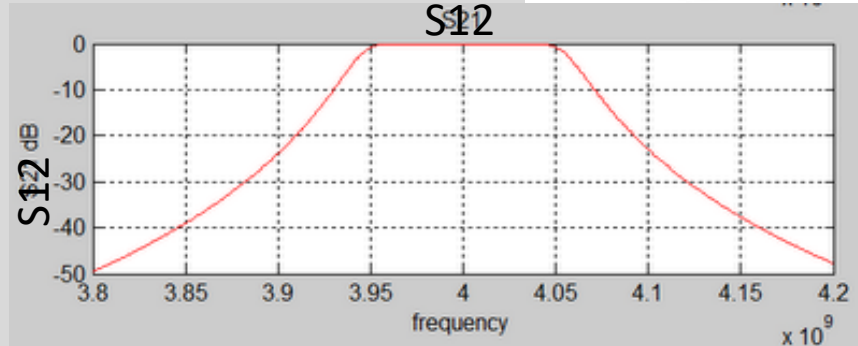
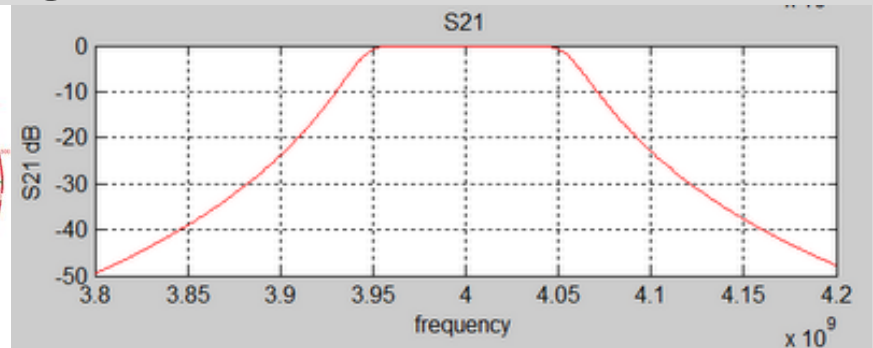
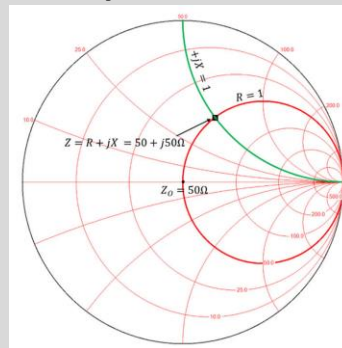

Circuit Design, Amplifier, Clock

- Clock Jitter/Phase noise in Digital System/Comms

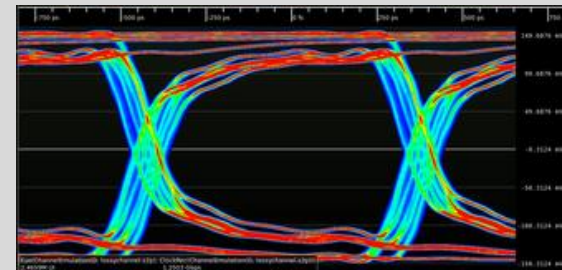
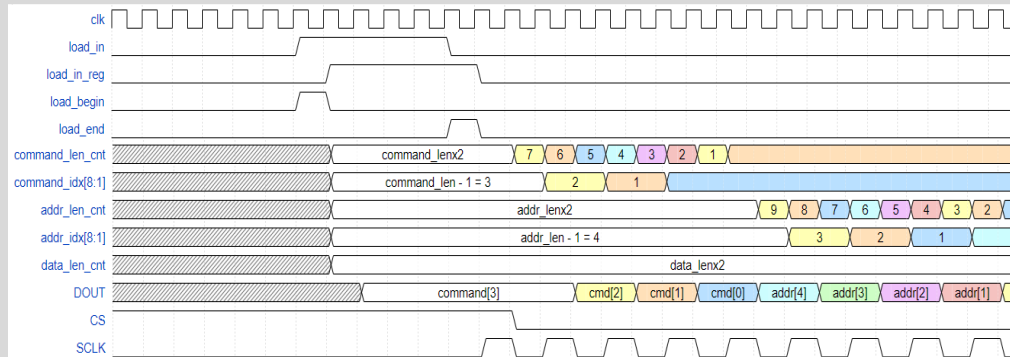

Circuit Design, Amplifier, Clock

- Clock Jitter/Phase noise in DAQ

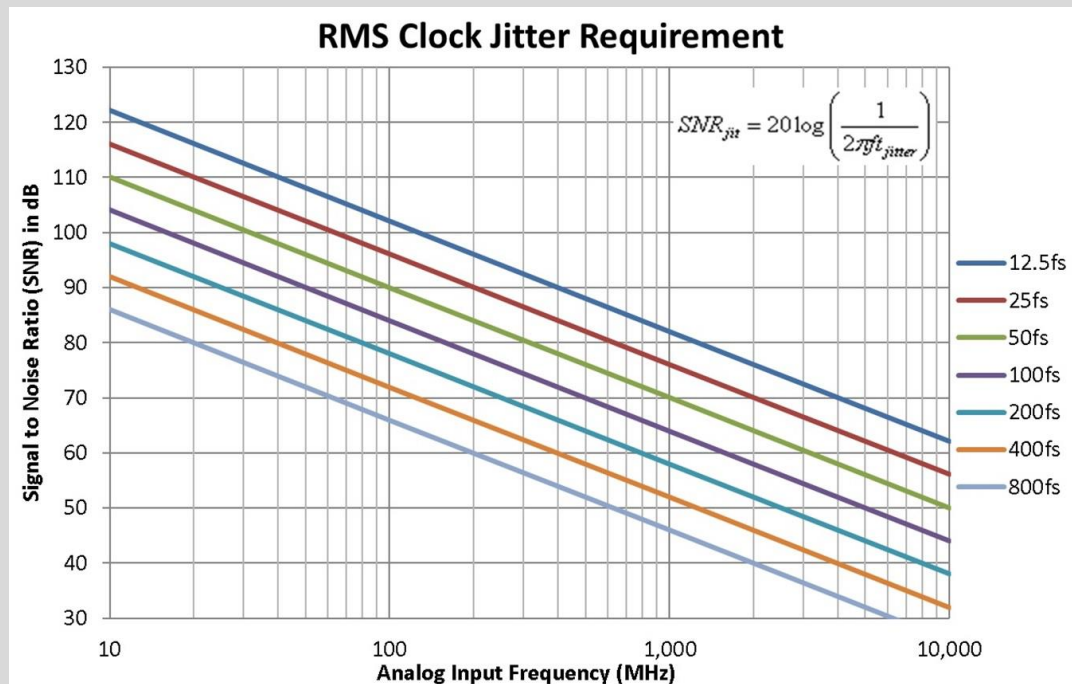

Circuit Design, Amplifier, Clock

- Clock Jitter/Phase noise

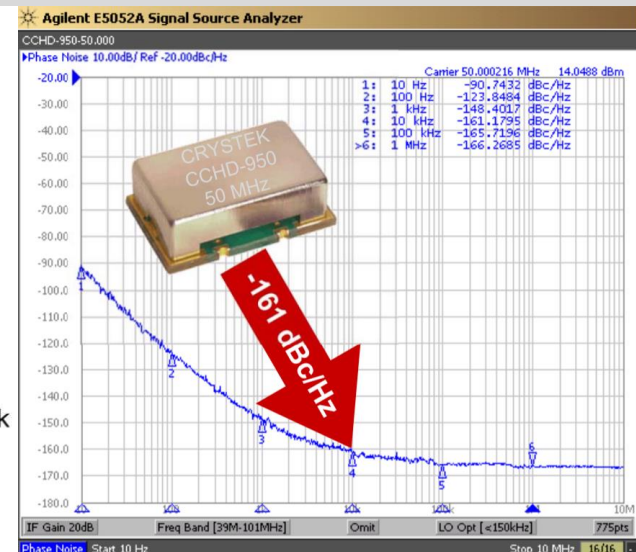
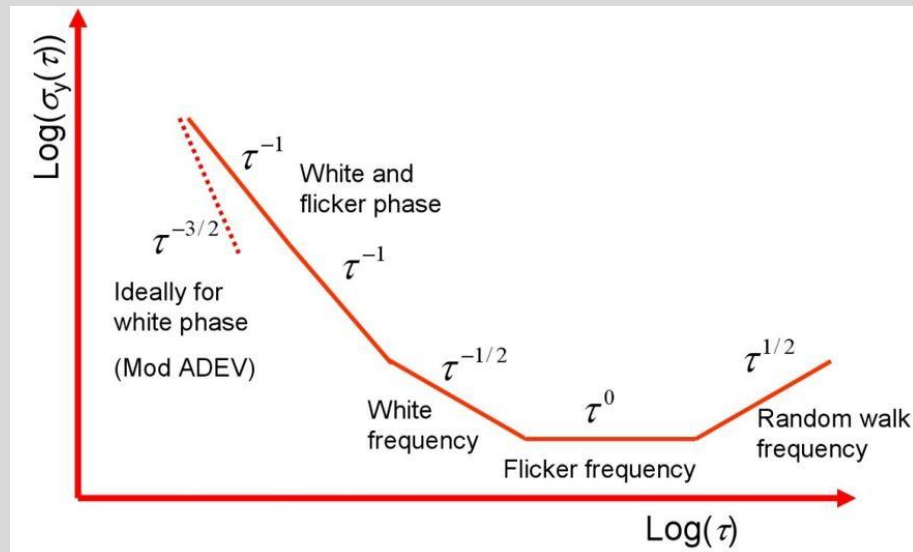

Source: NIST

Circuit Design, Amplifier, Clock

- Phase Locked Loop

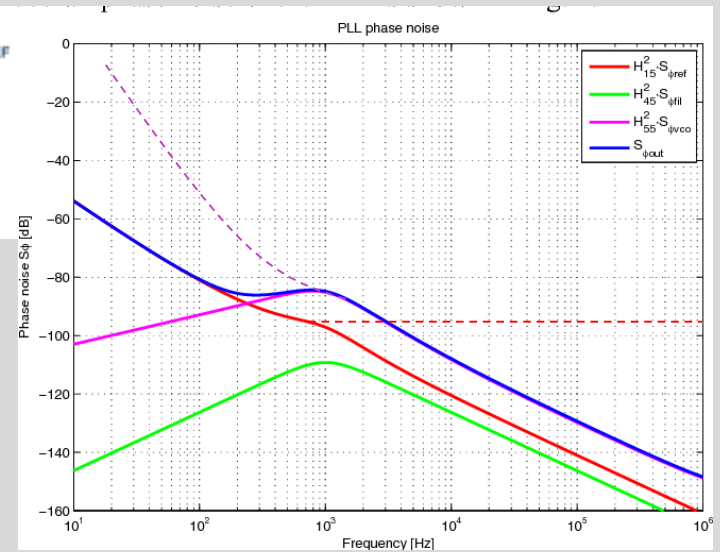
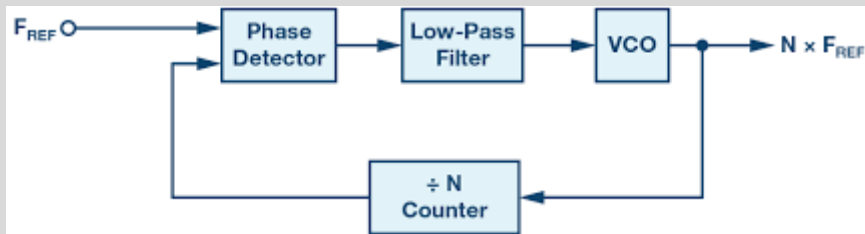

Circuit Design, Amplifier, Clock

• How to read datasheet

HMC1049LP5E

FEATURES

- Low noise figure: 1.8 dB
- P1dB output power: 14.5 dBm
- P_{SAT} output power: 17.5 dBm
- High gain: 15 dB
- Output IP3: 29 dBm
- Supply voltage: $V_{DD} = 7$ V at 70 mA
- 50 Ω matched input/output (I/O)
- 32-lead, 5 mm \times 5 mm LFCSP package: 25 mm²

APPLICATIONS

- Test instrumentation
- High linearity microwave radios
- VSAT and SATCOM
- Military and space

GENERAL DESCRIPTION

The HMC1049LP5E is a GaAs MMIC low noise amplifier (LNA) that operates between 0.3 GHz and 20 GHz. This LNA provides 15 dB of small signal gain, 1.8 dB noise figure, and an IP3 output of 29 dBm, yet requires only 70 mA from a 7 V supply. The P1dB output power of 14.5 dBm enables the LNA to function as a local oscillator (LO) driver for balanced, I/Q, or image rejection mixers. V_{DD} can also be applied to Pin 21, although Pin 21 requires a bias tee with $V_{DD} = 4$ V. The HMC1049LP5E amplifier I/Os are internally matched to 50 Ω , and the device is supplied in a compact, leadless 5 mm \times 5 mm LFCSP package.

Figure 1.

HMC1049LP5E

SPECIFICATIONS

$T_A = 25^\circ\text{C}$, $V_{DD} = 7$ V, $I_{DD} = 70$ mA¹.

Table 1.

Parameter	Min	Typ	Max	Min	Typ	Max	Min	Typ	Max	Unit
FREQUENCY RANGE	0.3			1			14		20	GHz
GAIN	13.5	16.5		12	15		10	13		dB
Gain Variation Over Temperature		0.006			0.019			0.017		dB/°C
NOISE FIGURE		2.5	3.5		1.8	2.5		2.7	4.0	dB
RETURN LOSS										
Input		15			13			14		dB
Output					15			13		dB
OUTPUT										
Output Power for 1 dB Compression (P1dB)		15			14.5			13		dBm
Saturated (P_{SAT})		18			17.5			16		dBm
Output Third-Order Intercept (IP3) ²		31			29			26		dBm
TOTAL SUPPLY CURRENT		70			70			70		mA

¹ Adjust V_{DD} between -2 V to 0 V to achieve $I_{DD} = 70$ mA typical.
² Measurement taken at P_{1dB} to $I_{DD} = 8$ dBm.

HMC1049LP5E Data Sheet

ABSOLUTE MAXIMUM RATINGS

Table 2.

Parameter	Rating
Drain Bias Voltage (V_{DD})	10 V
Drain Bias Voltage (RF Out/ V_{DD})	7 V
RF Input Power	18 dBm
Gate Bias Voltage, V_{GG}	-2 V to +0.2 V
Channel Temperature	175°C
Continuous P_{DSS} ($T = 85^\circ\text{C}$) (Derate 37.1 mW/°C Above 85°C)	3.34 W
Thermal Resistance (Channel to Ground Paddle)	26.9°C/W
Temperature	
Storage Temperature	-65°C to +150°C
Operating Temperature	-40°C to +85°C
ESD Sensitivity (HBM)	Class 1A

Table 3. Typical Supply Current vs. V_{DD}

V_{DD} (V)	I_{DD} ¹ (mA)
5	70
6	70
7	70

¹ Adjust V_{DD} to achieve $I_{DD} = 70$ mA.

ESD CAUTION

ESD (electrostatic discharge) sensitive device. Charged devices and circuit boards can discharge without detection. Although this product features patented or proprietary protection circuitry, damage may occur on devices subjected to high energy ESD. Therefore, proper ESD precautions should be taken to avoid performance degradation or loss of functionality.

Stresses at or above those listed under Absolute Maximum Ratings may cause permanent damage to the product. This is a stress rating only; functional operation of the product at these or any other conditions above those indicated in the operational section of this specification is not implied. Operation beyond the maximum operating conditions for extended periods may affect product reliability.

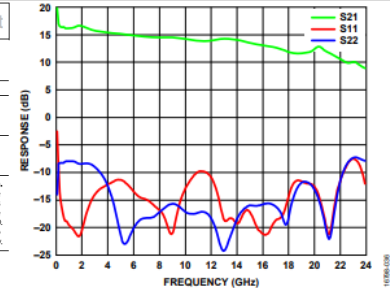

HMC1049LP5E Data Sheet

PIN CONFIGURATION AND FUNCTION DESCRIPTIONS

Table 4. Pin Function Descriptions

Pin No.	Mnemonic	Description ¹
1, 3, 6 to 12, 14, 17 to 20, 23 to 29, 31, 32	NC	No Connect. These pins are not connected internally; however, all data was measured with these pins connected to RF/dc ground externally (see the Typical Performance Characteristics section for data plots).
2	RFIN	RF Input. This pin is dc-coupled and matched to 50 Ω .
5	V_{DD}	Power Supply Voltage for the Amplifier. External bypass capacitors (100 pF and 0.01 μ F) are required.
30	RFOUT/ V_{DD}	Low Frequency Termination. An external bypass capacitor of 100 pF is required.
21	RFOUT/ V_{DD}	RF Output/Alternate Power Supply Voltage for the Amplifier. An external bias tee is required when used as alternative V_{DD} . This pin is dc-coupled and matched to 50 Ω .
15, 16	ACG2, ACG3	Low Frequency Termination. External bypass capacitors of 100 pF are required.
13	V_{GG}	Gate Control for Amplifier. Adjust the voltage to achieve $I_{DD} = 70$ mA. External bypass capacitors of 100 pF, 0.01 μ F, and 4.7 μ F are required.
4, 22	GND	Ground. Connect Pin 4 and Pin 22 to RF/dc ground.
0	EP	Exposed Pad. The exposed ground paddle must be connected to RF/dc ground.

¹ See the Interface Schematics section for pin interfaces.

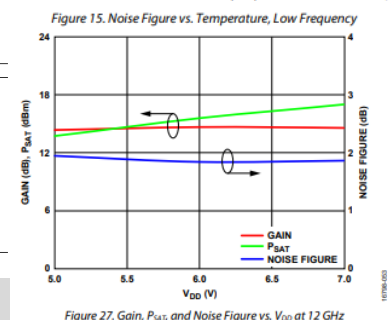
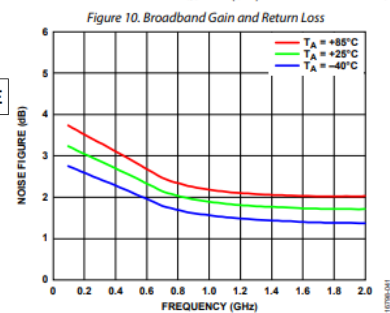

Simulation - LTspice

- Schematic Level
- Layout Level
- Structural model – SPICE
- Behavioral model – IBIS
- Scattering model – S-parameter

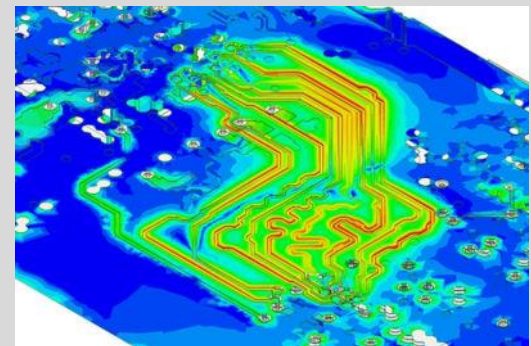

Simulation - LTspice

- ADS by Keysight
- Electronics Desktop by Ansys
- LTspice by Analog Devices
- Qucs (under GPL license)

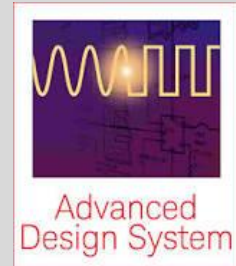

Simulation - LTspice

- Transient
- AC
- DC Sweep
- Noise

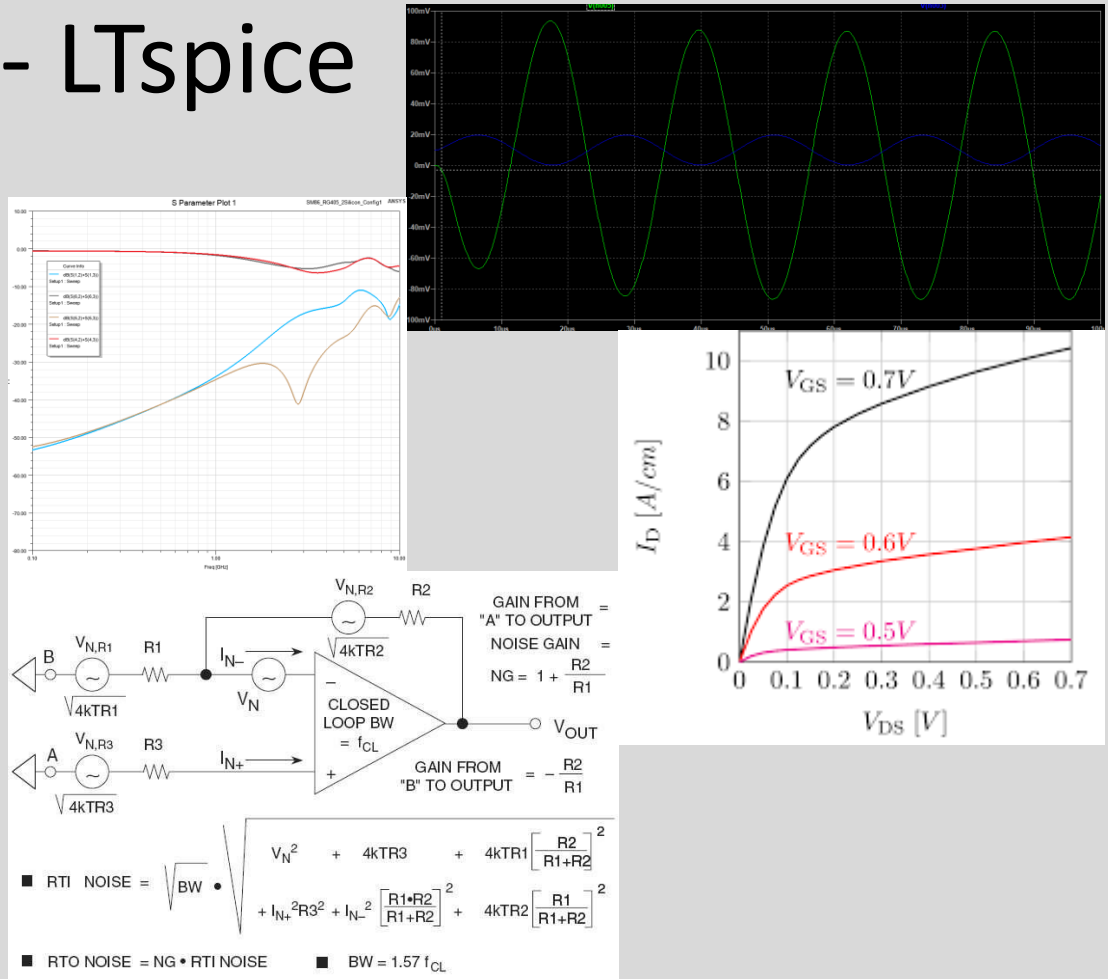

Simulation - LTspice

- Layout Level - SIwave

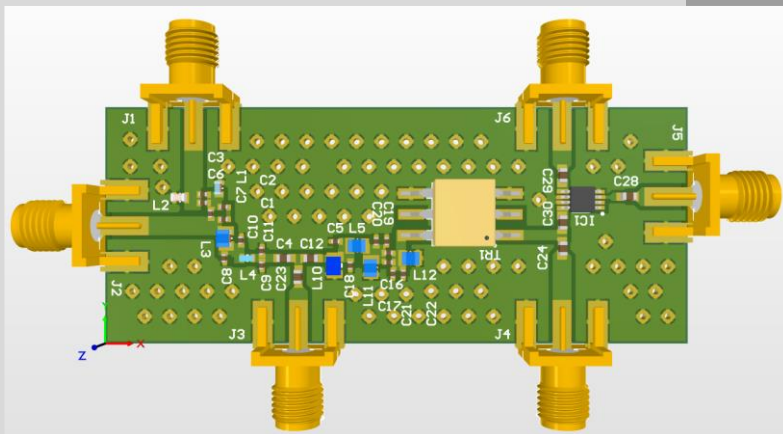
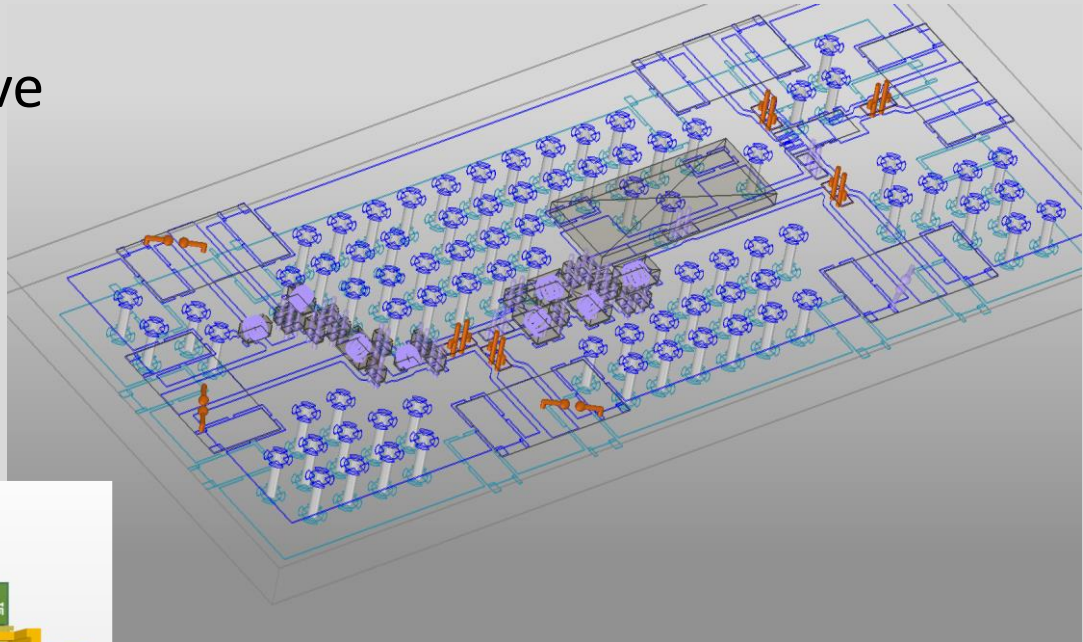

Simulation - LTspice

- Transient
- AC
- Noise

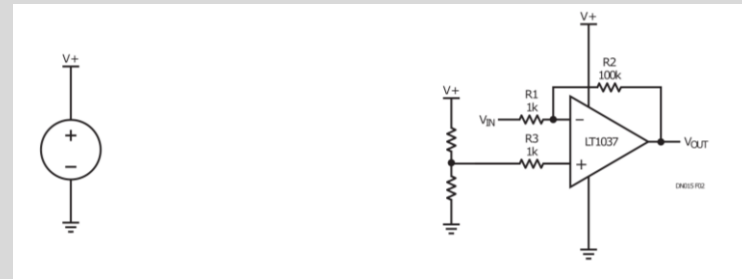

Simulation – Qucs – Match Circuit



**Low Noise Amplifier,
0.01 GHz to 10 GHz**

HMC8411LP2FE

Data Sheet

FEATURES

- Low noise figure: 1.7 dB typical
- Single positive supply (self biased)
- High gain: 15.5 dB typical
- High OIP3: 34 dBm typical
- 6-lead, 2 mm x 2 mm LFCSP

APPLICATIONS

- Test instrumentation
- Military communications

FUNCTIONAL BLOCK DIAGRAM

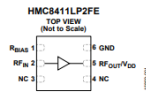

HMC8411LP2FE
TOP VIEW
(Not to Scale)

1 RF_IN 2 RF_OUT 3 GND 4 NC

Figure 1.