

What I will be talking about

- This week: mechanical structures
 - Session 1: Purpose of structures, track-based alignment, requirements for positioning and stability, loads (vibration, thermo-mechanical, etc.)
 - Session 2: 1D oscillator, Miles' equation, vibration studies (base vibration and air flow), structure design examples
- Next week: Thermal management
 - Session 1: Silicon systems cooling requirements, sensor temperature and runaway, prediction methods, thermal path design, thermal conductivities of structural and interface materials, case studies
 - Session 2: Cooling technologies (air, monophasic, evaporative), evaporative cooling systems (emphasis on CO₂), evaporator design (incl. microchannels), prediction methods and performance verification, engineering aspects
- A lot of stuff is from a review article I wrote some time ago:
 - G. Viehhauser 2015 JINST 10 P09001, doi:10.1088/1748-0221/10/09/P09001
 - Also has lots of references

Mechanical structures

Georg Viehhauser

Purpose of structures

- Silicon detectors are typically segmented into modules
 - The size of these modules is defined by wafer and/or chip sizes
- Typically, a silicon detector system will consist of a few ten to several 1000 modules
- Large coverage will usually require the spreading of these modules over a large volume
- They need to be held in space by support structures
- Tracking will usually require linking measured positions from several modules, which can be metres away from each other
 - The relative positioning of these modules is called alignment
- The support should not degrade the module-internal measurement accuracy
 - This is typically at the level of μm
- The support structure should achieve this with minimal material
- Additional tasks:
 - Support services (cables, fibres, cooling pipes, etc.)
 - Sometimes part of the thermal management (conductive heat paths) – more on this next week
 - Sometimes part of the grounding & shielding system – not part of this course

Material

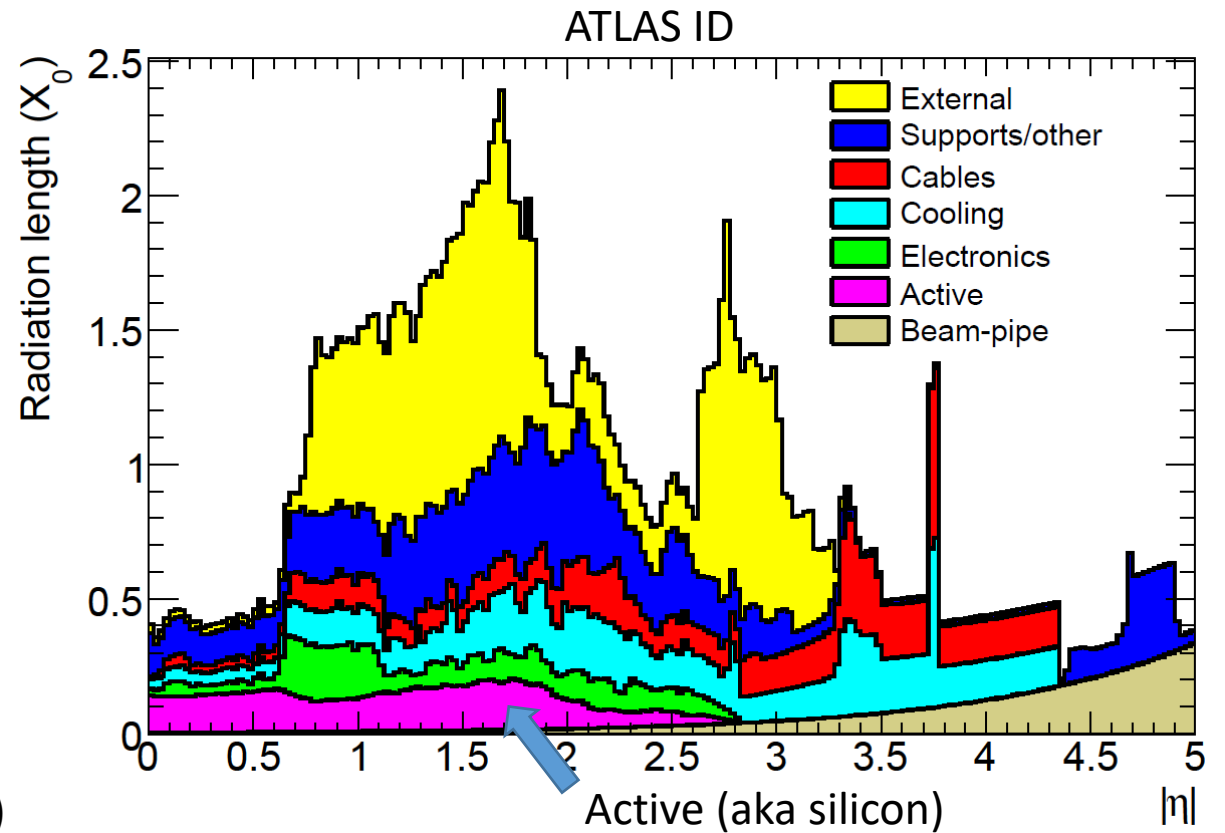
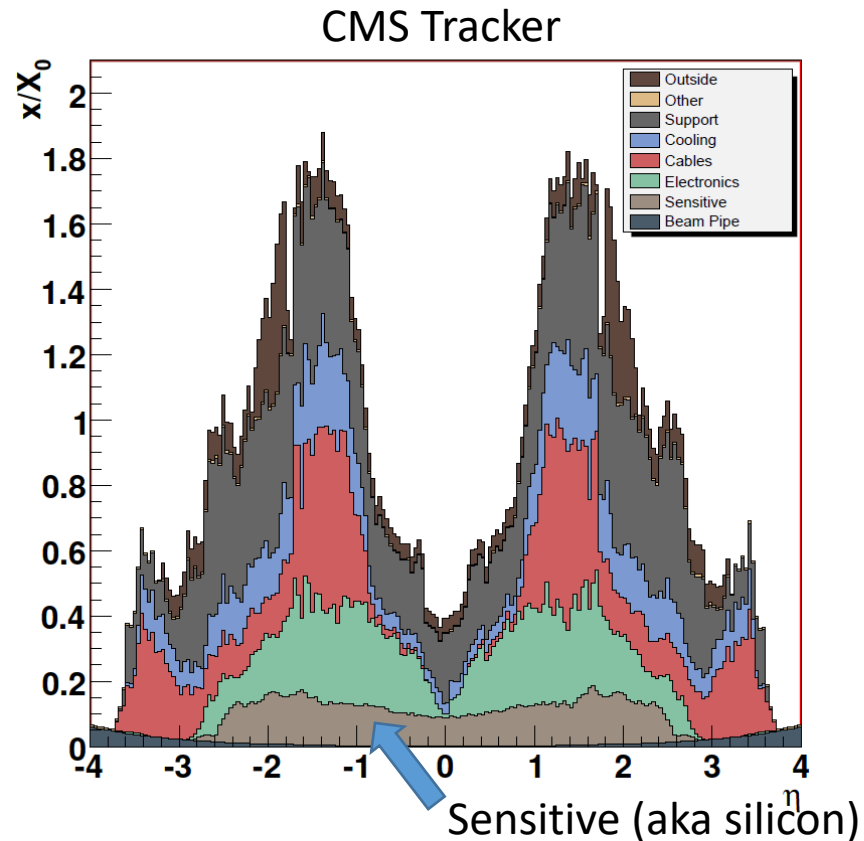

- Tracker material dominated by non-sensor material
- Material in cylindrical geometries grows with $\sin^{-1}\theta$
- In particular material is a problem in front of endcaps (barrel services cross on the way out)

Alignment strategies

- To be able to reconstruct a track in a several metre tracking system, the positions of the modules must be known
 - This is known as alignment
- Several strategies are conceivable
 1. Position modules accurately
 - μm positioning accuracy on this scale is extremely challenging (aka impossible)
 - In particular, because structures are deforming under static and dynamic loads
 2. Build system and survey after build
 - Still suffers from deformations under dynamic loads
 3. Hardware alignment systems
 - A system that measures in real-time the dimensions of the system, independent of the primary particle tracking function
 - Examples for this later, but key difficulty here is that fiducial positions for such a system are usually weakly connected to module positions – extrapolation of module positions is challenging
 4. Track-based alignment (TBA) – aka software alignment
 - Selected real tracks are used to find module positions
 - This is nowadays the most powerful approach
 - Even if this sounds like it does rely on data/software only, that's not true. The support structure needs to support TBA to make it work

Track-based alignment

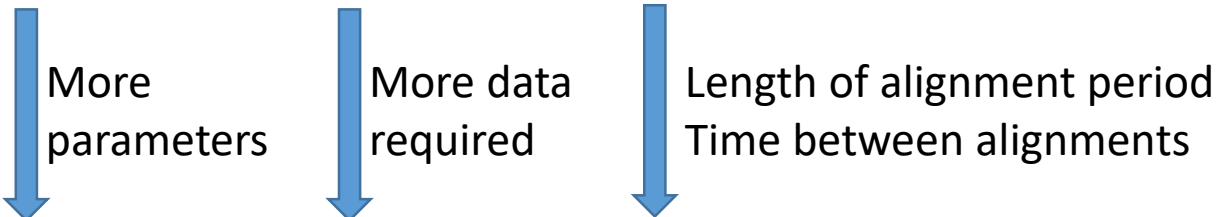
- For TBA a subset of real data is used
 - Typically well-constructed tracks with high momentum
 - To get enough statistics need to accumulate data for finite alignment periods
 - The length of these periods depend on the granularity of the alignment, and the rate of events (luminosity)
 - Then create a huge X^2 with all the tracks and as parameters the positions/orientations of the substructures
 - This is typically done in granularity hierarchies
 - Sub-detectors (barrel, endcap, etc.)
 - Large structures (cylinders, disks, etc.)
 - Local supports (staves/ladders, petals, etc.)
 - Individual modules
 - At the highest level TBA can be done at ATLAS/CMS daily (few hours at SLHC)
 - Deformations below the level of individual modules can also be reconstructed
 - Example: CMS barrel pixels – calibration of module bows
 - To keep parameters manageable requires realistic deformation models/parametrizations
 - Number of parameters can be reduced if positions of subgroups of modules can be mechanically constrained
 - Either build with high accuracy, or survey after construction – must not deform under dynamic loads
 - Developed for reconstruction of ATLAS & CMS – now used for all particle physics silicon systems
- 
- More parameters More data required Length of alignment period
Time between alignments

Challenges for TBA

1. Weak modes

- These are certain classes of deformations with coherent degrees of freedom
- Not constrained by the global X^2 fit – the results for these parameters are arbitrary
 - That means that even if the system is perfectly positioned an arbitrary deformation will be introduced
- Solutions:
 - Cosmics
 - Higher level physics analysis (reconstruct mass peaks and see that they are correct for all directions)

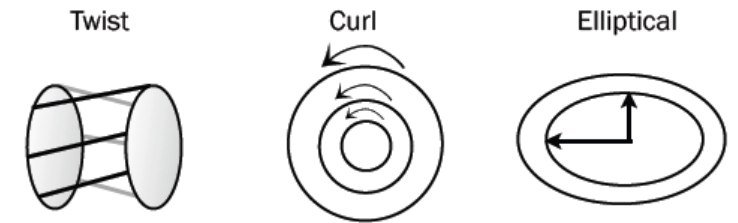

	$\Delta f(r)$	$\Delta f(\varphi)$	$\Delta f(z)$
Δr	radial expansion	elliptical	bowing
$\Delta \varphi$	curl	clamshell	twist
Δz	telescope	skew	z expansion

2. Position perpendicular to detector plane

- High-momentum tracks typically cross detector planes perpendicularly – low sensitivity to perpendicular plane displacement
- While this will have a small effect for the high-momentum tracks used for the alignment, this can be an issue for low-momentum tracks
- Solutions:
 - Cosmics
 - This is an example where other (mechanical) means of position control or knowledge can be helpful (at the level of $<100 \mu\text{m}$)

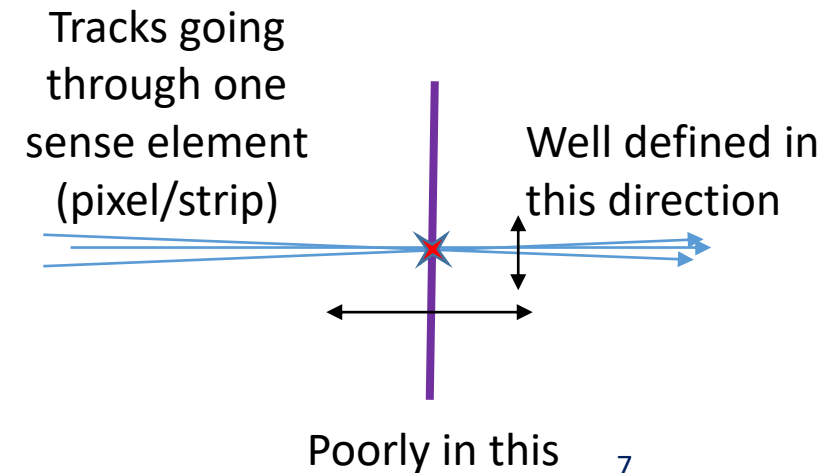

Hardware alignment

- During planning for LHC experiments not full confidence that TBA will work
 - Fall-back solution: hardware alignment system
 - Based on light beams (represent infinite momentum tracks)

ATLAS

- Frequency Scanning Interferometry (FSI)
- Interferometric system for absolute length measurement with sub- μm precision
- System consists of a beam splitter quill and a retroreflector per beam
- These were mounted in a geodetic grid throughout the strip system
- Installed, but not read out

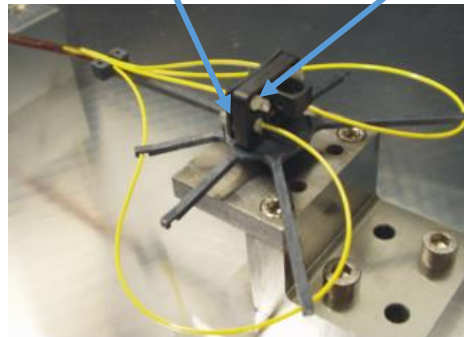
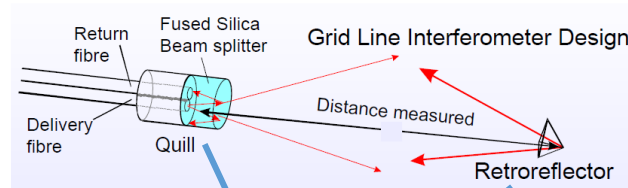
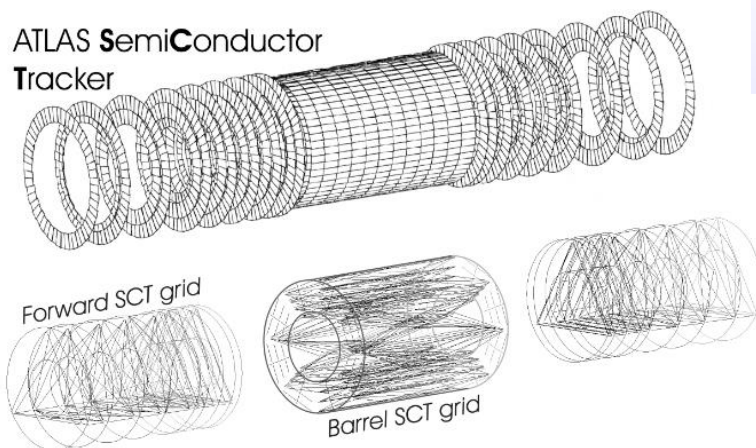

CMS

- Silicon is semi-transparent to infrared, but CMS modules have opaque Al backplane
- A small number of standard tracker sensors have been made with a hole in metallization
- Laser beams are shone through this areas
- Advantage is that you get position of modules (but only a small number)
- Read out, but only used to identify seismic shocks to the system

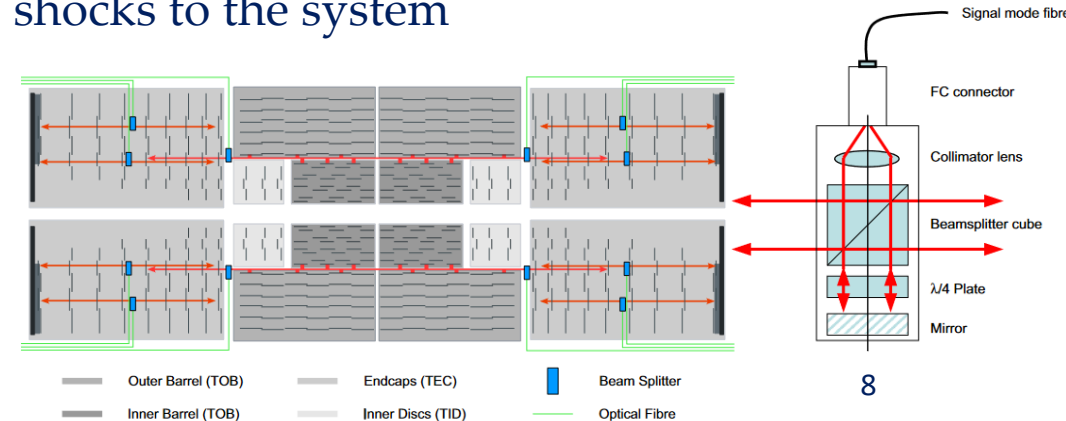

Requirements for structures

- #1 requirement is stability of the module positions over the duration of an alignment period
 - This does require identification of the loads that are relevant, and their time scales (will discuss later)
 - Typically, stability must be comparable to module precision ($\sim 1 \mu\text{m}$)
- Module placement is secondary
 - Everything needs to fit together
 - Clearances (for installation or HV) need to be maintained
 - Overlaps needed for tracking hermeticity and TBA must maintained
 - All these are typically a very few $100 \mu\text{m}$
- A sociological observation: The TBA community and the mechanical community are very different
 - Communication is very difficult – we are using different languages and there is a reluctance to engage with the tools of the other community
 - But it can be extremely fruitful and is worth the effort
 - In particular, necessary to understand the requirements for structures

Stiffness and strength

- In structural mechanics there are two different properties – stiffness and strength
 - Stiffness means small deformation under (limited) loads
 - Strength is ability to maintain structural integrity under (high) loads
- At low loads the two are somewhat correlated
- However, in the high performance regime they become complementary
 - A strong structure must be able to deform to absorb the energy imparted by the load
 - Simple example (for a static load): A rope stretched between two points sags under gravity. To get it straight you would need to put on infinite tension – the rope would snap
- In typical engineering applications the primary requirement is strength
 - For example aircraft wings can take enormous forces, but deform by metres
- Typical particle physics experiments (apart from space-based) are static and loads are tiny
 - Our application is therefore (as often the case) non-mainstream, and this has implications for designs and materials
 - Strength is usually only required to the level that it allows for handling during the construction of the experiment

Composite structures

- The most efficient structural materials are carbon fibre reinforced plastics (CFRPs)
 - Efficiency here means stiffness/material
 - CFRPs consist of a matrix of carbon fibre, embedded in a polymer
 - The polymer is typically cured in an autoclave at elevated temperature (for polymerization) and pressure (for compaction) from a resin (which is tacky at room T)
 - Typical cure temperatures are below 100°C (low T cure), around 125°C (medium cure T), or 170-200°C (high T cure) – dependent on resin
 - The higher the T, the bigger the thermal stress is locked in; the lower it is the shorter the shelf life of the material is, and the lower the glass transition T
 - Pressure is usually a few bar
- Typical resin material is epoxy or cyanate ester
 - We like the latter because it is very radiation hard and has a low CME (coefficient of moisture expansion)
 - These can be procured already soaked into a prepreg, or on its own if needed as a glue or for wet lay-ups (where dry prepreg is used and the user infuses the resin)
- Alternative fibre materials are glass fibre or synthetic fibres like Kevlar (Aramid)
 - These usually have lower modulus, and are thus less useful for high stiffness applications (better for high strength)

Carbon fibre - manufacture

- Carbon fibres are fibres of about 5 to 10 μm diameter (1/10 of human hair)
- Several 1000s of fibres (filaments) are spun into a tow
 - Filament number (tow size) depends on brand
- Start with a polymer such as polyacrylonitrile (PAN), rayon, or petroleum pitch
- Then heated to drive off non-carbon atoms (carbonization)
- The final production step is a coating to protect them from damage during winding or weaving
 - This is called sizing - process and material is proprietary
- The carbon fibres are then often prepared in woven or uni-directional pre-preg and impregnated with resin

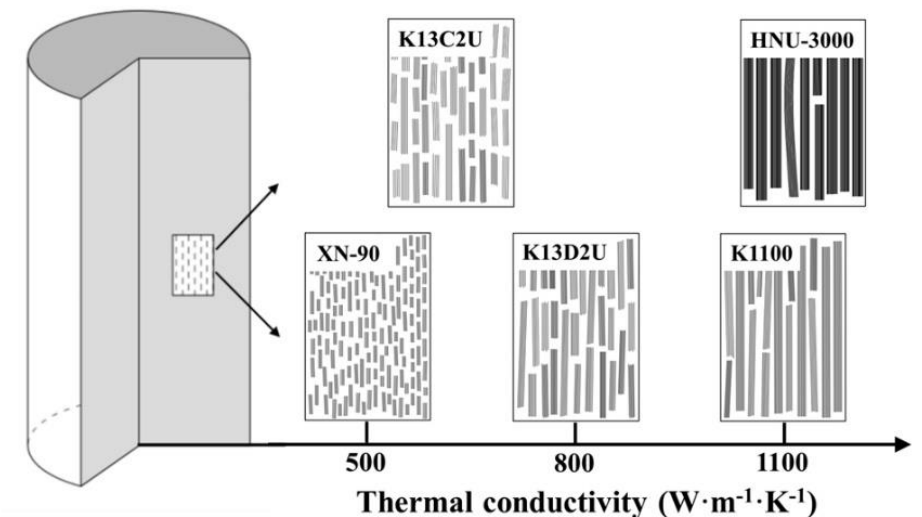
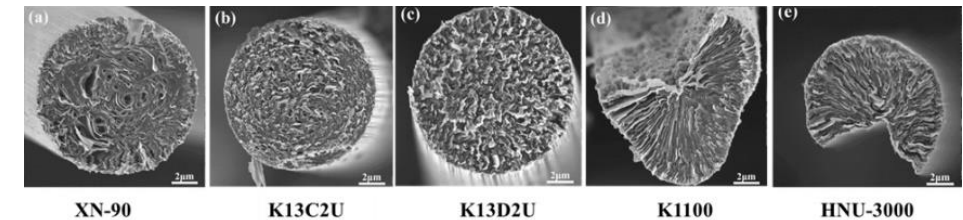

Composites design

- Carbon fibre design is fundamentally different from machining metal
- Design for metal structures involves removal of material (subtractive machining), and then usually connection by bolts
 - Metal designs therefore often involve straight and square geometries
 - Manufacture requires placement of the piece into a machine for the material removal
 - This becomes more difficult and precision harder to achieve the larger the piece is
 - Recently, additive metal manufacturing is changing this paradigm
- Composites on the other hand comprise often sheets, which are appropriately shaped
 - Structural performance is often achieved by shaping, and the design optimizes the shape according to the loads, which typically results in non-square forms
 - Composites are anisotropic, so design is significantly more complex
 - Shaping of composite structures in principle gives a lot of freedom for geometries
 - In particle physics we are often not exploiting these possibilities (even if work with CF)
 - we tend to design in cylinders or disks
 - Apart from being structurally inferior, this also is suboptimal in reducing tracker material
- Joints are usually bonded
 - Bolted connections are actually difficult and require inserts and local reinforcements
 - Because carbon fibre is so structurally powerful, it often is actually the bonds, which limit the structural performance
- Structural dimensional precision is best not achieved by machining of precision interfaces, but by gluing parts held in place by precision jigs



What we have now:

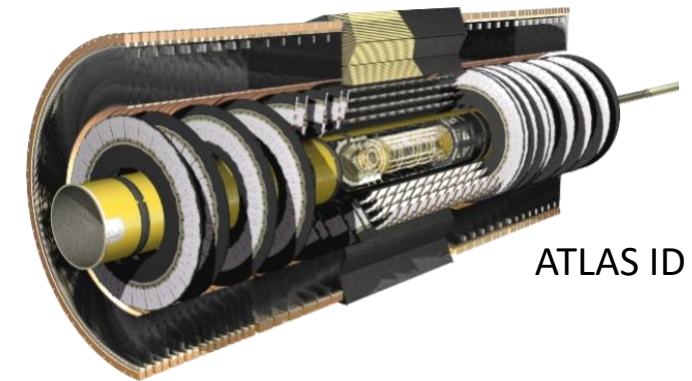

The most efficient tracker geometry:

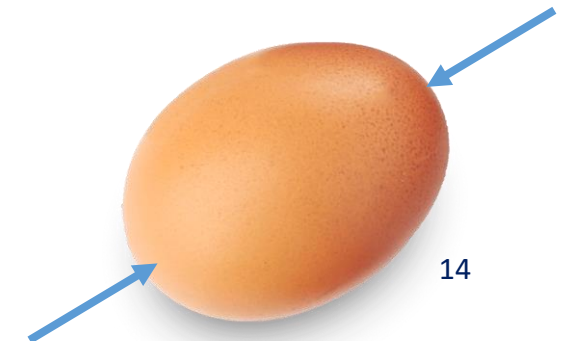

Type of loads

- In order of increasing time scales (relevant to correlate with duration of stability required)
 - Vibrations (timescale seconds)
 - External (seismic and/or from other parts of experiment) or internal (typically flow of coolant)
 - Thermo-mechanical (seconds to hours)
 - Structures and modules contain elements with different CTE, so temperature changes over time will lead to load changes
 - This can also be due to changes in power consumption, because of thermal impedance of thermal path from heat source to local heat sink (coolant)
 - Seismic shocks (days to months)
 - Significant perturbations or change of state, usually brief, but with significant times of stability between
 - Examples are magnet ramp/quench, power or cooling system stoppage (planned and unplanned)
 - Long-term effects of static loads (months to years)
 - For example creep or relaxation effects
 - Humidity effects
 - No defined time of change, but over long time scales
-
- Relevant within TBA periods
- Sets boundaries of TBA periods
- Tracked by TBA

How to minimize thermo-mechanical effects

- Large silicon detector systems are a complex mixture of different materials
 - Generally, they will have different CTEs (coefficients of thermal expansion)
 - Hence the structures will encounter temperature-dependent deformations (like a bi-metallic strip)
 - These can also be power-dependent, because of temperature gradients along thermally resistive conduction paths from the heat source to the local heat sink (typically coolant)
 - Often, but not only, this is due to trigger rate variations within a fill
- What strategy?
 1. Equalize temperatures and power consumption (good number: $\pm 0.5\text{-}1^\circ\text{C}$)
 - This is an important requirement that needs to be made clear to the cooling and the electronics people in your collaboration from early on
 2. Design symmetric structures
 - Thermal strains balance – minimize deformations
- Example of what can go wrong: ATLAS IBL
 - Electrical cable bonded to one side of local support only
 - Does require temperature control at the level of 0.2 K and regular alignment correction in the offline reconstruction

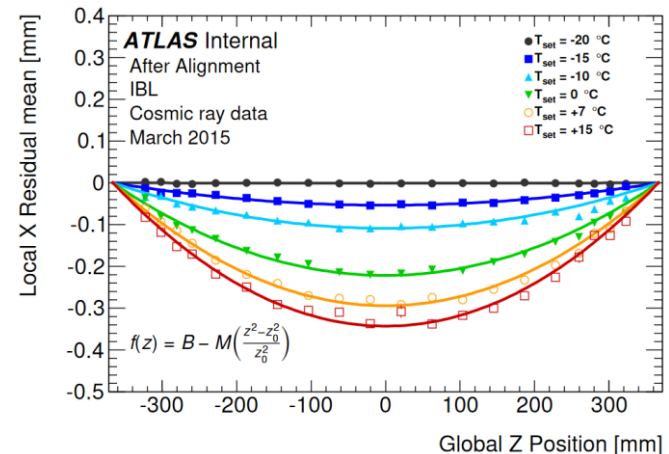
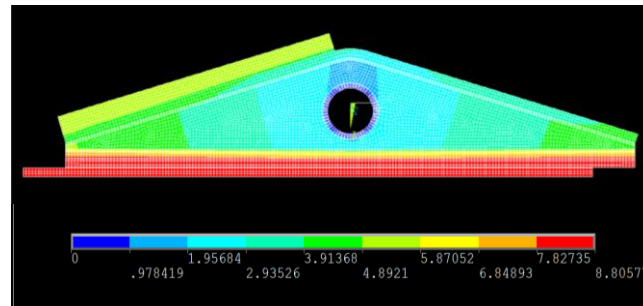
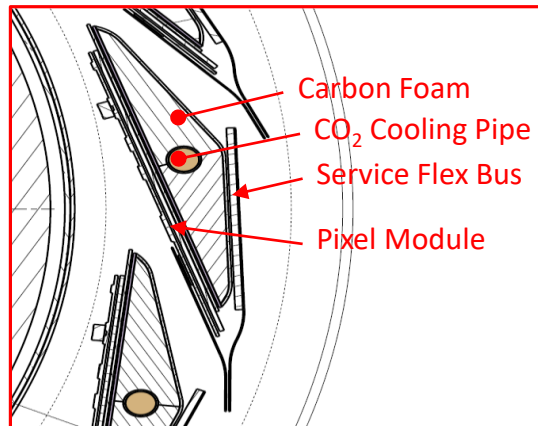

External vibrations

- External vibrations are most usefully described by a vibration spectrum
 - These are usually shown as power spectra
- Two versions:
 - Acceleration spectral density (ASD) – often in g^2/Hz : More useful for load spectrum
 - Displacement spectral density (DSD) – in something like $\mu\text{m}^2/\text{Hz}$: More useful for response spectrum
 - Connection is $DSD = \frac{ASD}{(2\pi f)^4}$
- For a given external vibration spectrum the displacements of the structures will have a spectrum $DSD_{structure}(f) = H(f)ASD_{ext}(f)$, where $H(f)$ is the response function of the structure
 - $H(f)$ can be obtained from FEA or measurements
- Typically, external vibration spectra in static particle physics experiments are low
 - A common misconception is that they have some special feature at line frequency
- The external vibration spectrum depends on your location and environment
 - Ideally, they need to be measured for your specific experiment, but this is not always possible in advance
 - I have seen spectra for a range of experiments, with one exception, they have all been (well) below $10^{-7} g^2/\text{Hz}$
- As we will discuss more quantitatively in the next lecture, these vibration levels are very low, and displacements due to external vibrations easy to be controlled
 - In fact, I have the suspicion that most silicon detector supports are over-designed

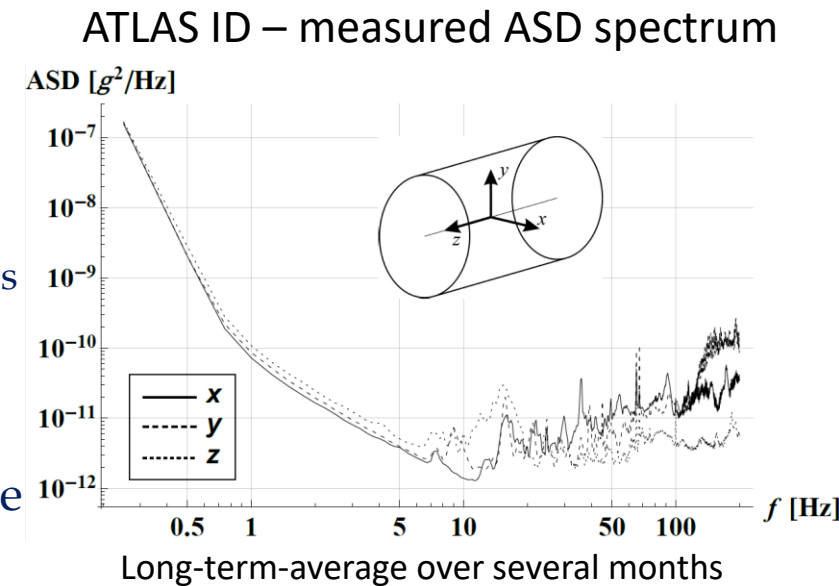

Summary

- The most powerful method to align detector modules is track-based alignment
- The mechanical design must enable, facilitate and support this
- The prime requirement for the mechanical design is stability at $O(1\mu\text{m})$
 - For a definition of stability the specification of loads is required
 - This also requires a specification of time scales
- Typically, the relevant loads are
 - Temperature variations
 - Vibrations (internal and external)
- Placement requirements are usually much more relaxed $O(100\mu\text{m})$
- The most capable material are carbon fibre composites
 - Because our requirement is for stiffness, we typically use UHM carbon fibre, which not your standard CF
 - Carbon fibre design relies on shapes – lots of opportunities to optimize structures and layouts

Mechanical structures II

Georg Viehhauser

1D oscillator – Miles' equation

- To understand the response of a periodically excited object we start with a very simple model, a 1-D damped oscillator ($m\ddot{x} + c\dot{x} + kx = F_{ext}(t)$)

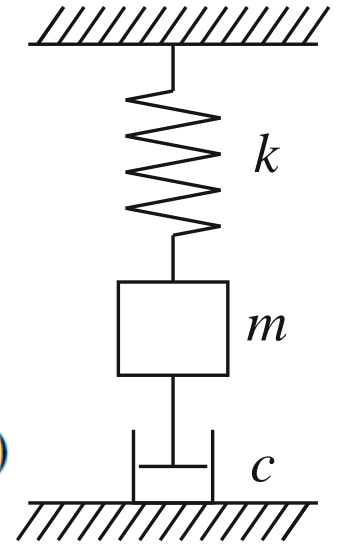

$$\frac{x(f)}{F(f)} = \frac{1}{k} \frac{f_0^2}{f_0^2 - f^2 + 2i\zeta f f_0} = \frac{1}{(2\pi)^2 m} \frac{1}{f_0^2 - f^2 + 2i\zeta f f_0} \quad \text{with} \quad \begin{aligned} f_0 &= 1/(2\pi)\sqrt{k/m}, \\ \zeta &= c/(4\pi m f_0) \\ Q &= \sqrt{km}/c = 1/(2\zeta) \end{aligned}$$

- Integrate over all frequencies

$$a_{\text{RMS}} = \sqrt{\int_0^{\infty} \frac{ASD \cdot f_0^4}{(f_0^2 - f^2)^2 + 4\zeta^2 f^2 f_0^2} df} = \sqrt{\frac{\pi}{2} \cdot ASD \cdot f_0 \cdot Q}$$

$$\delta_{\text{RMS}} = \frac{a_{\text{RMS}}}{(2\pi f_0)^2} = \sqrt{\frac{ASD \cdot Q}{32\pi^3 f_0^3}}$$

Miles' equation: a good estimator of the dynamic response of a mechanical system

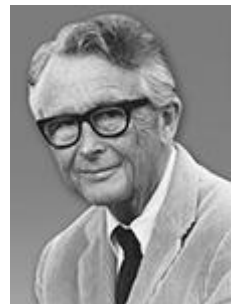

John W. Miles

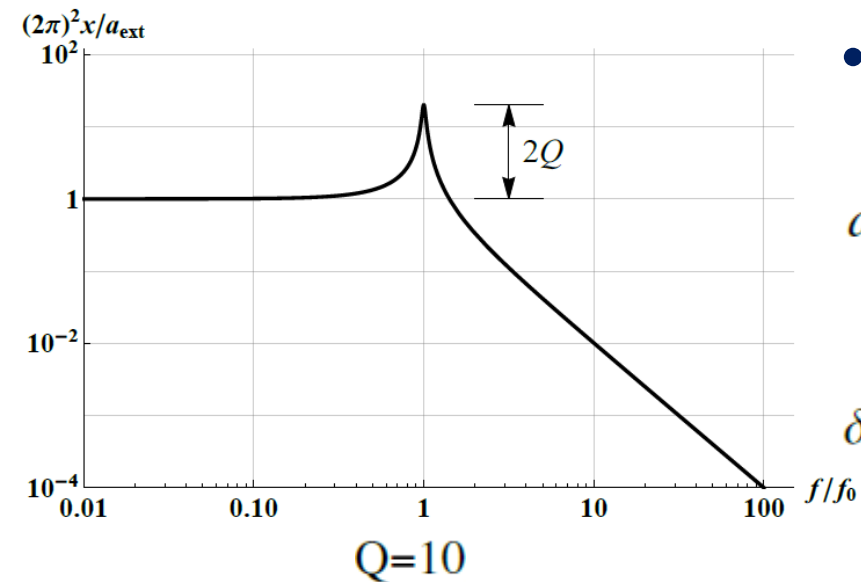

Milking Miles' equation

- If oscillator is loaded by external static force mg (gravity), f_0 can be expressed through the static deflection (sag) δ_g

$$f_0 = \frac{1}{2\pi} \sqrt{\frac{g}{\delta_g}} \quad \text{and} \quad \delta_{\text{RMS}} = \frac{\sqrt{\text{ASD} \cdot Q}}{2} \left(\frac{\delta_g}{g} \right)^{3/4}$$

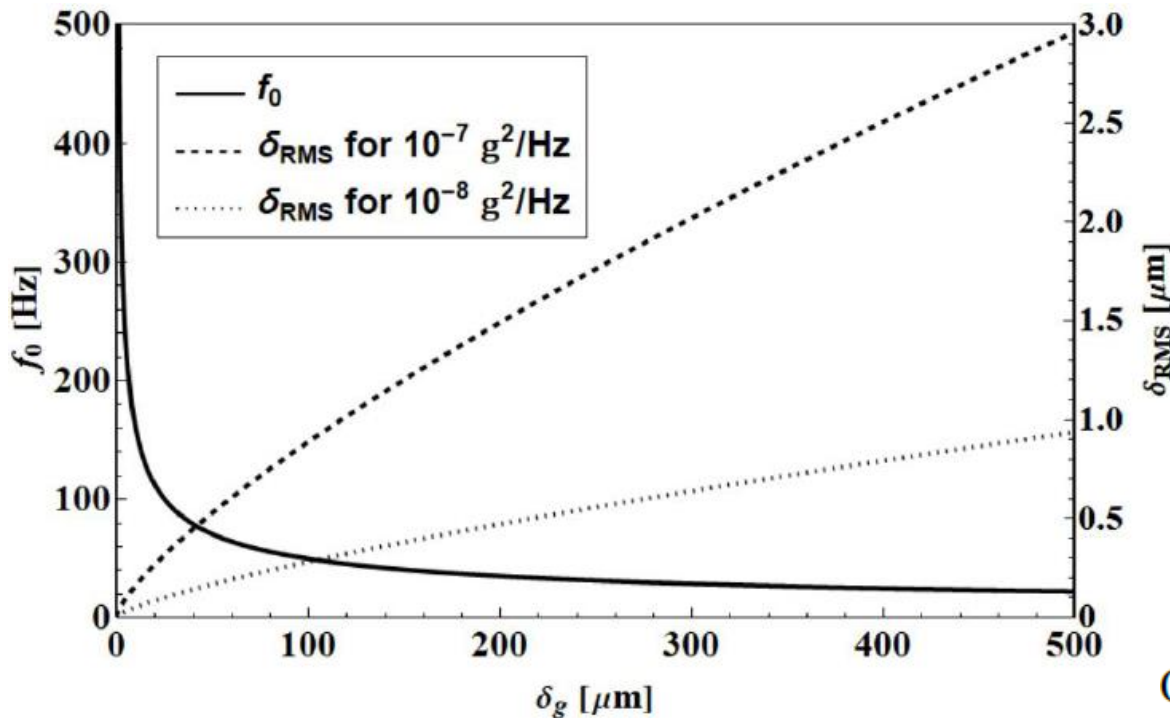

$Q=10$

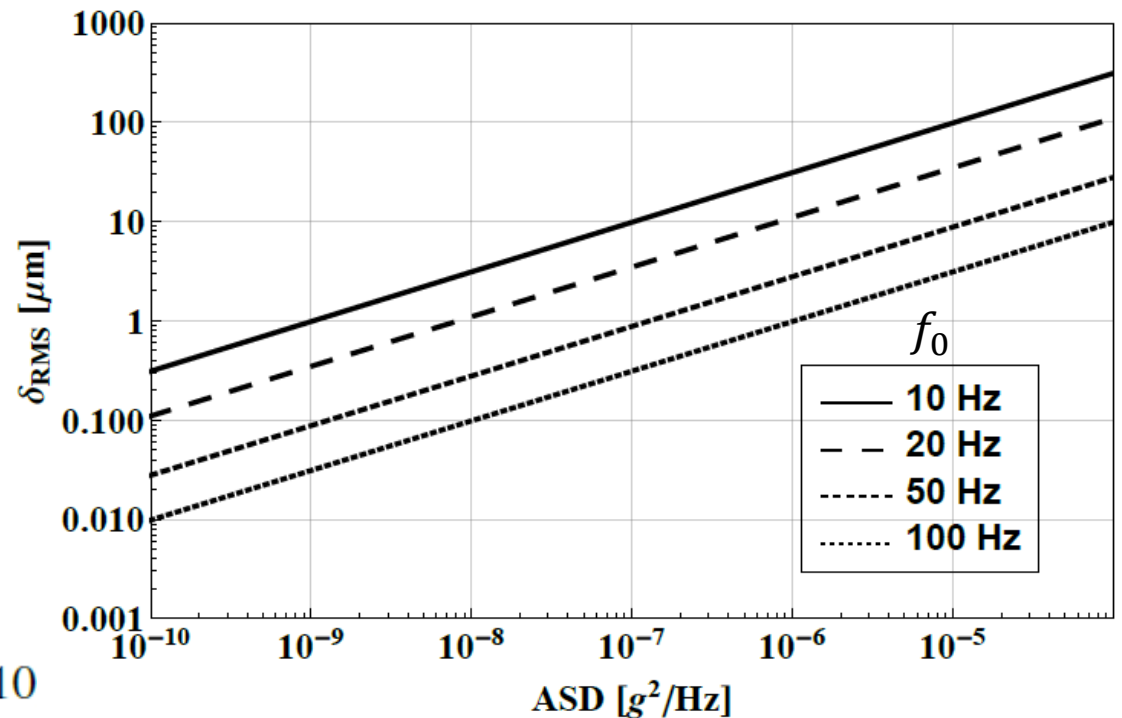

Simple beam theory

- But structures are complex 3D-objects: they have a much richer resonance structure
- Next level up: Bernoulli beam (essentially a 2D beam, with $d \ll l$)
 - Characterized by bending stiffness EI , with E the Young's modulus (material property), and I the (area) moment of inertia (beam geometry)

$$\lambda \frac{\partial^2 y}{\partial t^2} + c \frac{\partial y}{\partial t} + EI \frac{\partial^4 y}{\partial x^4} = \phi(x, t)$$

- After separation and boundary conditions

- Resonance frequencies: $f_n = \frac{1}{2\pi} \omega_n = \frac{\kappa_n^2}{2\pi} \sqrt{\frac{EI}{\lambda}}$, with $\begin{cases} \cos(\kappa_n l) \cosh(\kappa_n l) = 1, & \text{fixed - fixed} \\ \sin(\kappa_n l) = 0, & \text{simply supported} \\ \cos(\kappa_n l) \cosh(\kappa_n l) = -1, & \text{fixed - free} \end{cases}$
- Spatial part: $EI \frac{\partial^4 X_n}{\partial x^4} = \omega_n^2 \lambda X_n$

- Combined frequency response $y(x, f) = \frac{\phi(f)}{(2\pi)^2 \lambda} \sum_{n=1}^{\infty} \frac{\Gamma_n X_n(x)}{f^2 - f_n^2 + 2i\zeta f f_n}$ Superposition of 1-D oscillator frequency responses

- Weighted with modal participation factors $\Gamma_n = \int_0^l \lambda X_n(x) dx$

- which relate to modal mass $m_n = \Gamma_n^2$ with $m = \lambda l = \sum_{n=1}^{\infty} m_n$

Bernoulli beam example

- Beam length 1.08 m, $EI = 32.92 \text{ kgm}^3/\text{s}^2$, mass density 0.31 kg/m, $\zeta = 0.017$

Mode	Fixed-fixed			Simply supported			Fixed-free		
	$\kappa_n l$	f_n [Hz]	m_n/m	$\kappa_n l$	f_n [Hz]	m_n/m	$\kappa_n l$	f_n [Hz]	m_n/m
1	4.730	31.6	69.0%	13.9	81.1%	1.875	5.0	61.3%	
2	7.853	87.0	0	55.7	0	4.694	31.1	18.8%	
3	10.996	170.6	13.3%	125.4	9.0%	7.855	87.1	6.5%	
4	14.137	282.1	0	$n\pi$	222.9	0	10.996	170.6	3.3%
5		421.4	5.4%		348.2	3.2%	14.137	282.1	2.0%
6	$\approx \frac{(2n+1)\pi}{2}$	588.5	0		501.5	0	$\approx \frac{(2n-1)\pi}{2}$	421.4	1.3%
7		783.5	2.9%		682.6	1.7%		588.5	1.0%
Maximum gravitational sag	$\delta_g = \frac{\lambda g l^4}{384 EI}$ 325 μm ($x = 0.5l$)			$\delta_g = \frac{5\lambda g l^4}{384 EI}$ 1624 μm ($x = 0.5l$)			$\delta_g = \frac{\lambda g l^4}{8 EI}$ 15588 μm ($x = l$)		

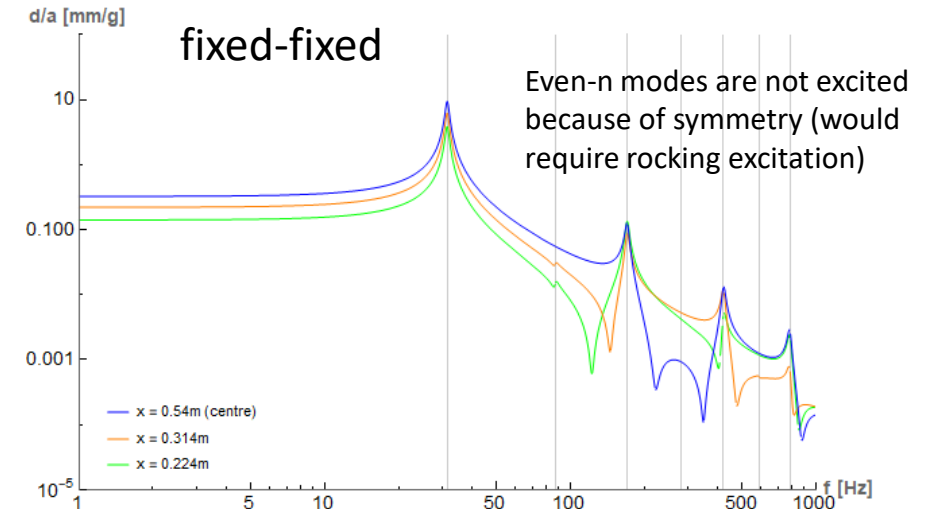

Comparison to 1D oscillator (use f1 as resonance frequency)	1 st mode max		2 nd mode max		3 rd mode max		Longitudinal RMS
	x/l	δ/δ_{1D}	x/l	δ/δ_{1D}	x/l	δ/δ_{1D}	
Fixed-fixed	0.5	132.0%	0.71	87.5%	0.79	54.7%	83.1%
Both ends simply supported	0.5	127.3%	0.75	90.0%	0.83	63.7%	90.0%
Fixed-free	1	156.6%	0.47	48.1%	0.69	91.0%	78.3%

- Note that higher modes do not contribute that much, because their resonance peak is already in the damping tail of the 1st mode \rightarrow Miles' equation is still a good predictor

Vibration response – external vibrations

- As usual, theoretical understanding needs to be backed up by experimental data
- To systematically study the frequency response use a shaker table
- Shaker tables are widely used in structural engineering (for example in space instrumentation)
 - However, usually these are for high loads ($> 1 g$) – much more than typical for (non-space) particle physics experiments
 - At Oxford we have built a low-acceleration shaker table (typically $1 mg$)
 - Challenge is that the displacement response is very small (a few nm at 500 Hz)
 - Interesting instrumentation

Setup with ATLAS stave core prototype

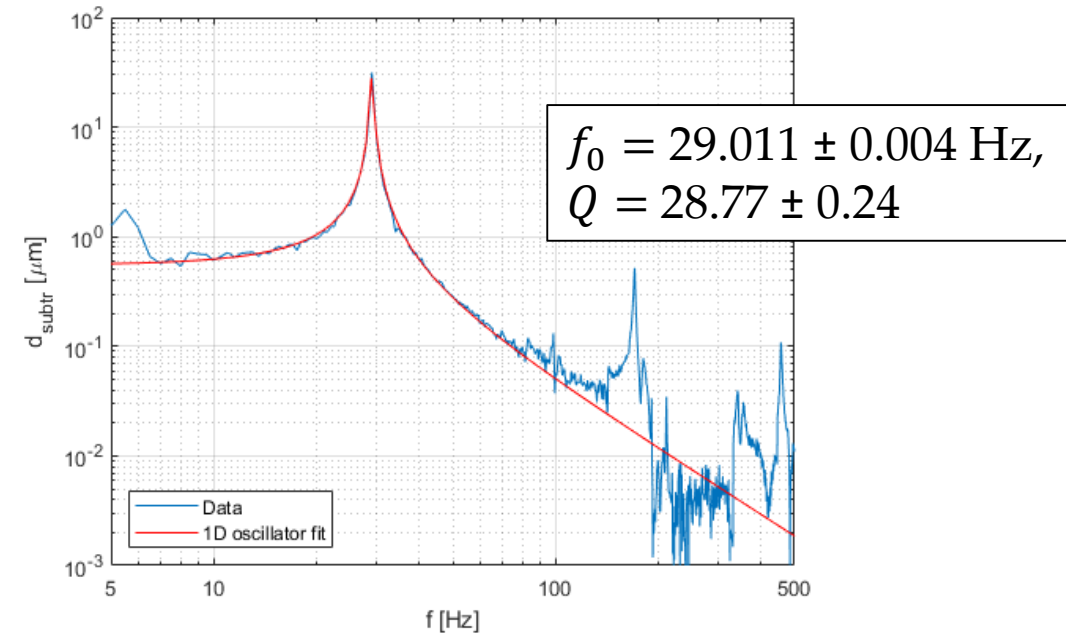
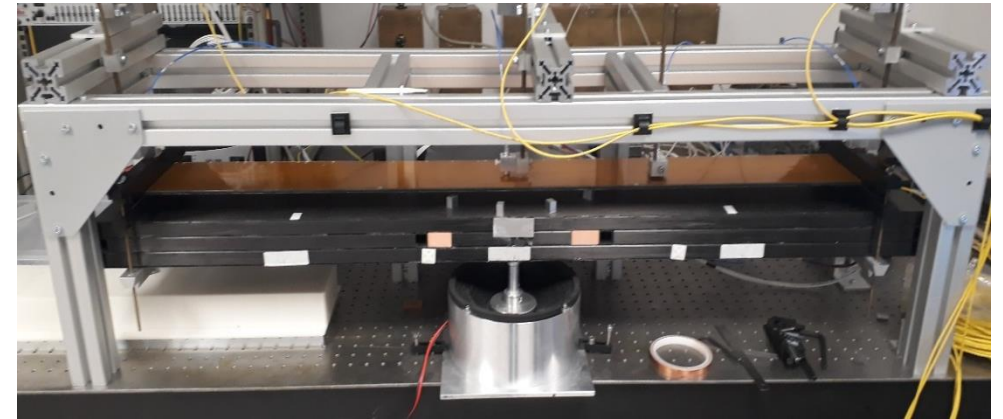

Bending stiffness

- We have seen with the Bernoulli beam that $f_1 \propto \sqrt{EI/\lambda}$, and from Miles' equation $\delta_{RMS} \propto f_0^{-3/2}$, so $\delta_{RMS} \tilde{\propto} (EI/\lambda)^{-3/4}$
- The relevant property of the structure (for a given mass density) is the bending stiffness EI
- E is the modulus of the beam material – material property
 - In our case that's dominated by the fibre
 - We have seen that it's already common to use UHM fibre – not much room for improvement
- $I = \int z^2 dzdy$, (area) moment of inertia, aka second moment of area – geometrical property
 - z is the distance from the neutral fibre, in symmetric cross-sections the neutral fibres is the centroid of the cross-section
 - The neutral fibre is the axis in the cross section along which there are no longitudinal stresses or strains
 - (if the cross-section is not up-down symmetric there is a non-zero product moment of area $I = \int yzdzdy$ and the beam will deflect sideways and downwards)

Example: square beam

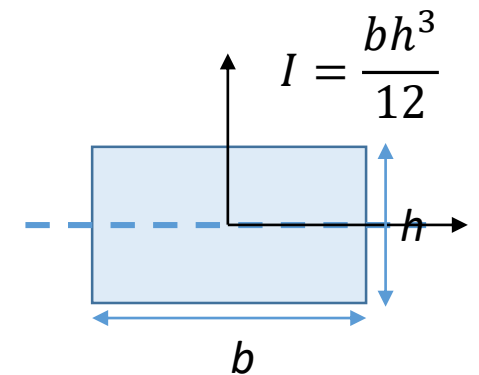

Buckling

- How do we improve stiffness (for a given amount of material)?
- Separate high-modulus layers ('skins')



- However, now we run into a new problem: buckling stiffness
 - Buckling theory is a little more advanced, but to give a feel:
 - A long, slender, ideal column will buckle if the axial load exceeds $F = \frac{\pi EI}{(KL)^2}$ (Euler 1757)
 - We know EI (this corresponds now to the bending stiffness of an individual skin)
 - KL is the effective length of the column (product of K , which is a support constraint factor, and L , the unsupported length)
 - Usually we are worried about plate buckling, for which similar expressions exist
- There are several ways to deal with buckling:
 - Fill the space between the two skins with (light) material, which is bonded to the skins throughout (e.g. foam, honeycombs...) – increases EI
 - Bond ribs to the skins - decreases KL
 - Add profile to the skin (grooves) – if these are in different directions, they will again decrease KL



... and the mysterious Q factor...

- The quality factor is a result of the damping of the system
- I do not know of a simple way to predict this factor, yet it contributes as much to the displacement response as the ASD
- In the study of a number of structures we have done it appears that bare mechanical structures have typically a Q value of a few 10
- However, structures equipped with sensors (or sensor dummies) and services (or service dummies) tend to have lower Q values
 - Which is what you would expect
- I would be very interested if anybody has an idea to predict this...

Vibration response – internal vibrations

- The most important source of internal vibrations is the flow of coolant through the system
- This is particularly a concern for air flow cooling, which is considered for future lepton colliders
- The exact prediction of displacement response is difficult, as it does depend on the coupling of the flow to the structure, which is a 3D problem
 - In particular if flow is turbulent
- However, because of the large modal mass, the structure will be dominantly excited in the first mode
- Again, we have built an experimental setup for this at Oxford

Example: Study of Plume ladders (supplied by Bristol)

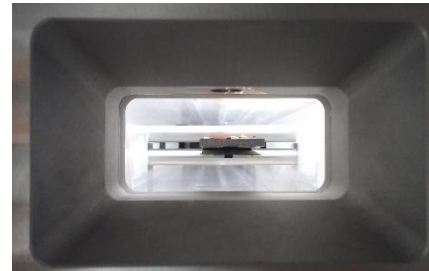
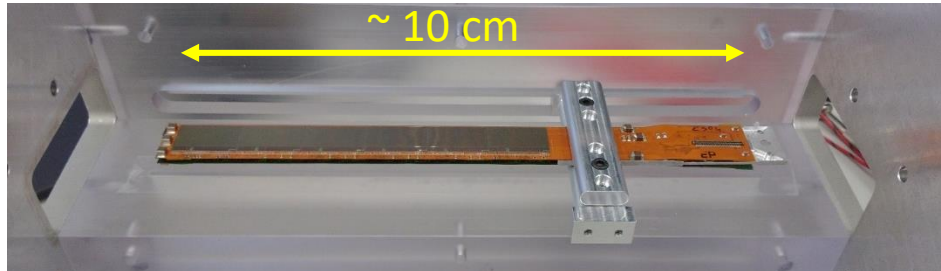

Unfortunately no visualization of flow...

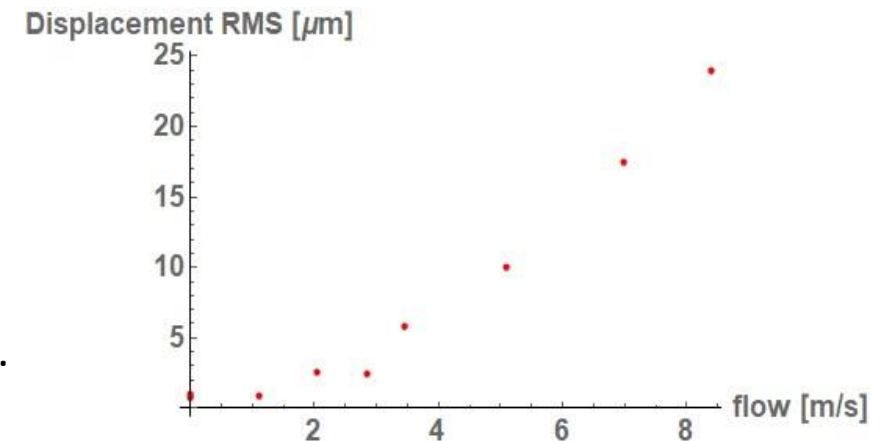
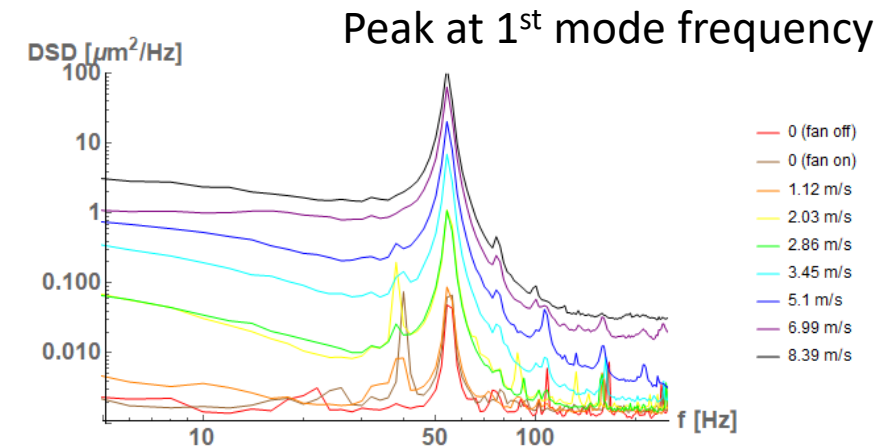

Service integration - electrical

- A secondary function of the support structures is to provide support for services
 - A simple approach is to provide support by clips or service channels
 - A more aggressive approach is to bond the services to the/into the structures
 - The key issue here is the management of coupling of forces (in particular thermo-mechanical) inside the services and the structure (see ATLAS IBL before)
- Electrical
 - Co-curing of Kapton/Cu or Kapton/Al flex circuits (for example ATLAS strips)
- Optical
 - No attempts known to me
 - However, an interesting topic in structural engineering is strain and integrity monitoring using Fibre-Bragg interferometry in embedded optical fibres (used for example in monitoring concrete structures) – this might be useable as a hardware deformation tracking system?...



Service integration - cooling

- In fluid forced flow cooling system standard is to use metal pipes
- Additional benefit from bonding is that it provides a good conductive path for heat from the heat sources to the cooling pipe
- Bonding these to the composite structures is challenging (CTE of metals and CF are significantly different)
- Cooling pipes from carbon fibre have been studied, but two major issues
 - CF cooling pipes are very stiff – need to be manufactured precisely to the right shape (metal pipe shapes can usually be adjusted in situ)
 - CF cooling pipes are not leak tight for CO₂ (CO₂ is a good solvent, and attacks the resin)
- A good compromise is to use a weak tube to co-cure with CF - Example: ALICE using Kapton tubes
- Another idea is to run the cooling in channels inside the silicon itself – more on this next week

ALICE IB



Pipe burst pressure @ 51bar
Leak-less water cooling

Transversal section:

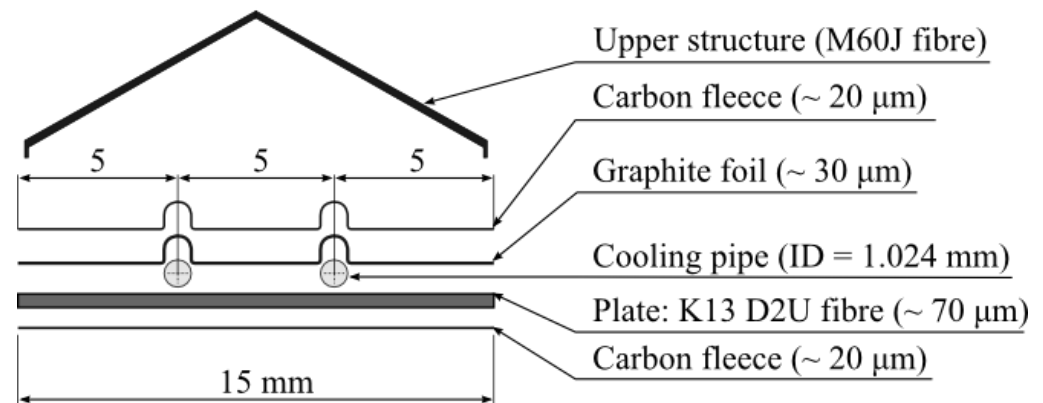

Case study: Plank structure (ATLAS barrel strip stave)

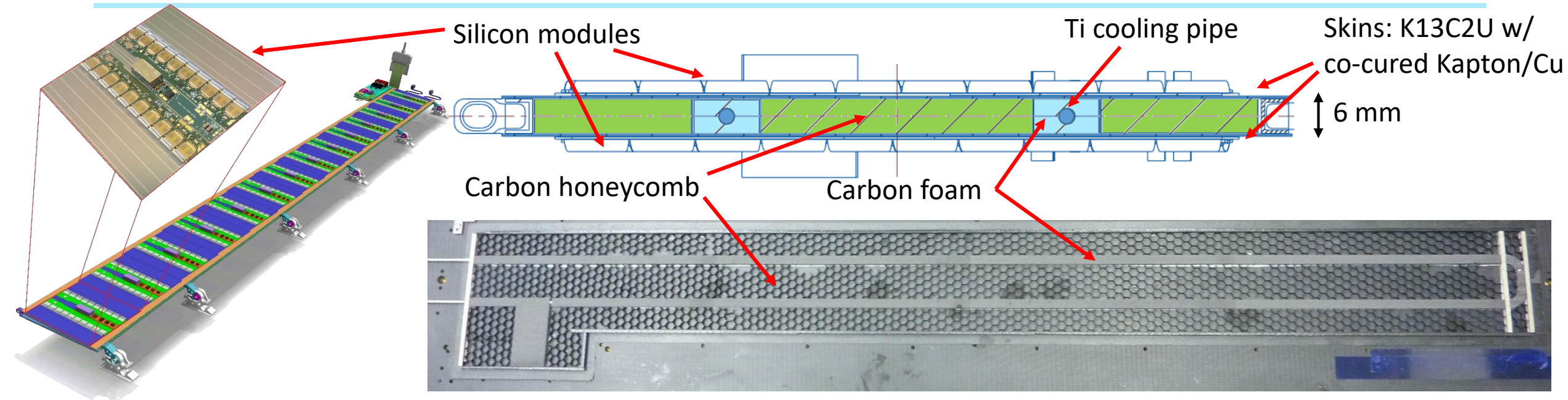

- Good thermal connection from silicon to cooling pipe (embedded in carbon foam with high thermal conductivity) – short thermal path
- High degree of symmetry to reduce thermo-mechanical deformation
- High buckling stiffness
- But stiffness-to-mass ratio not overwhelming (area moment of inertia limited)
- Interesting detail: Ti cooling pipe is bonded into foam. Despite FEA predicting that foam should break during thermal cycling, this was never observed in built stave
 - Shows the shortcomings of FEA, when modelling complex geometries

Case study: Truss structure (ALICE et al.)

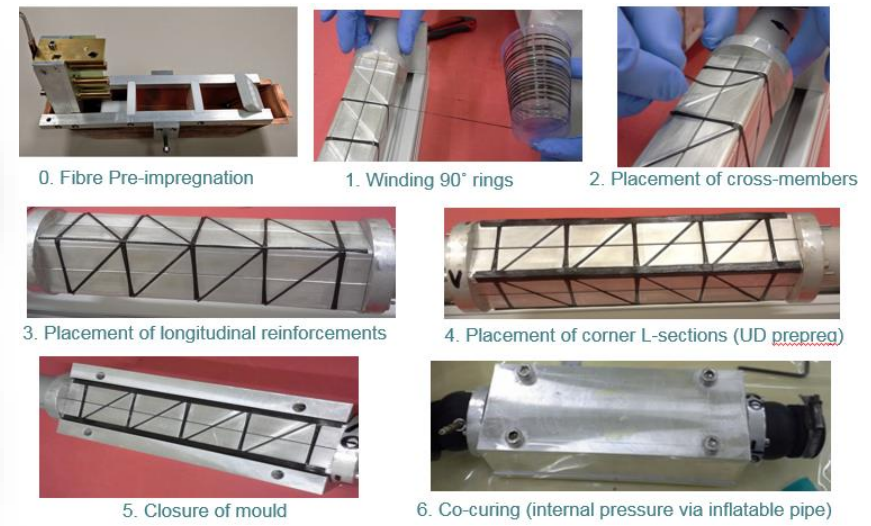
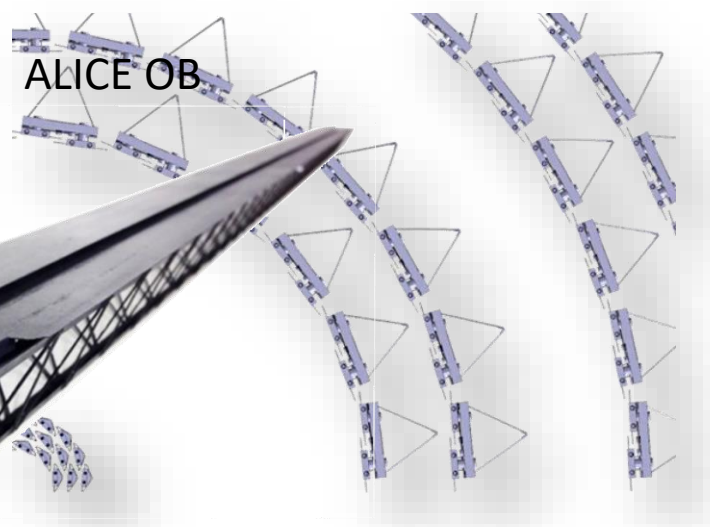
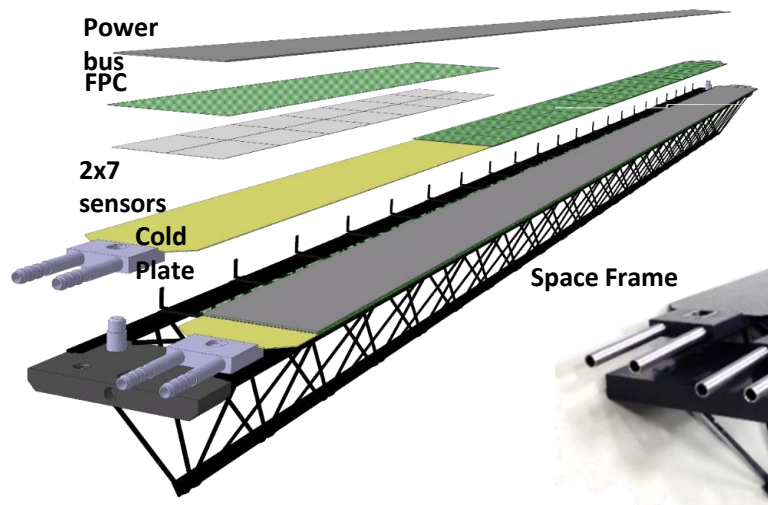

- Truss structures from filaments, which get soaked in resin, and then wound on a template
- Very high stiffness to mass ratio
- Performance difficult to predict (buckling, joint-driven) and complex mode spectrum (not only bending modes, but also torsional modes)

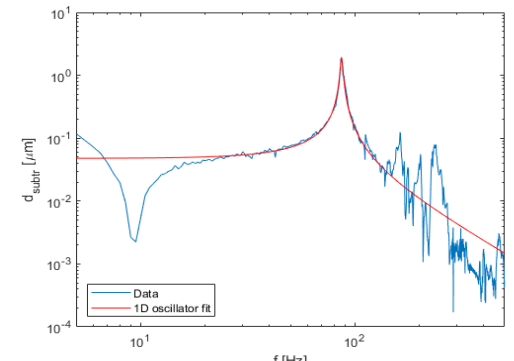
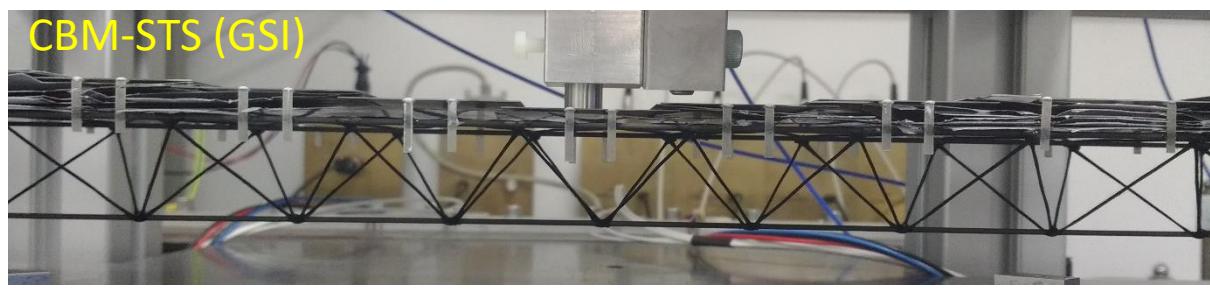

Case study: Box channel (STAR PXL)

- $0.4\%X_0/\text{layer}$
- Mechanics optimized for quick installation/de-installation
 - Structure consists of cantilevered sector tubes
- Air flow cooling through sector tube (9 m/s)
 - Sector first mode: 230 Hz (measured)
 - Sensor vibration at full flow: $5\ \mu\text{m}$ RMS
 - Sensor displacement at full flow: 25-30 μm
- No TBA assumed for design
 - All sensor positions surveyed on a half-detector
 - But TBA was used in the analysis

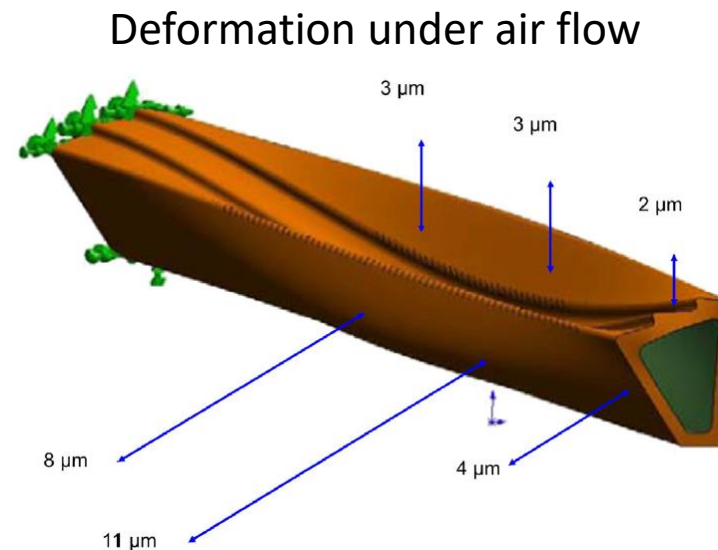
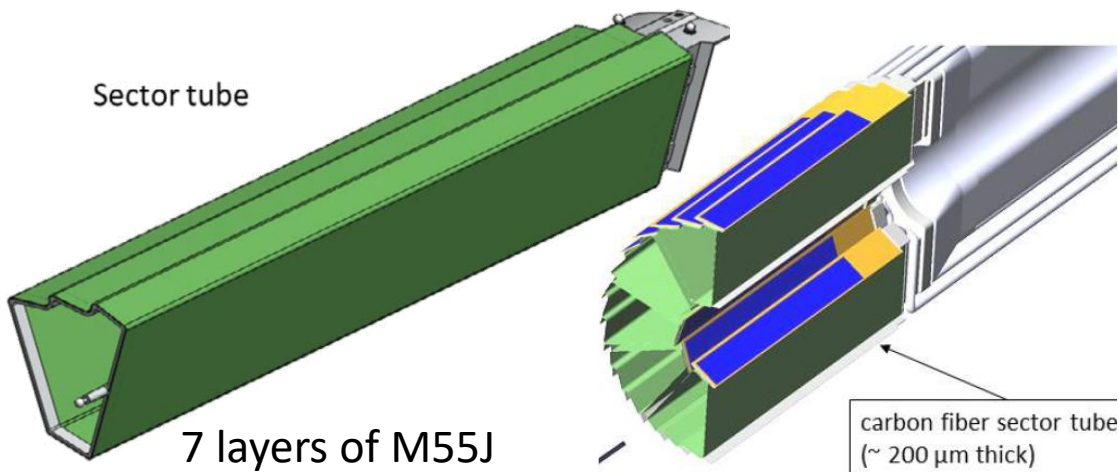
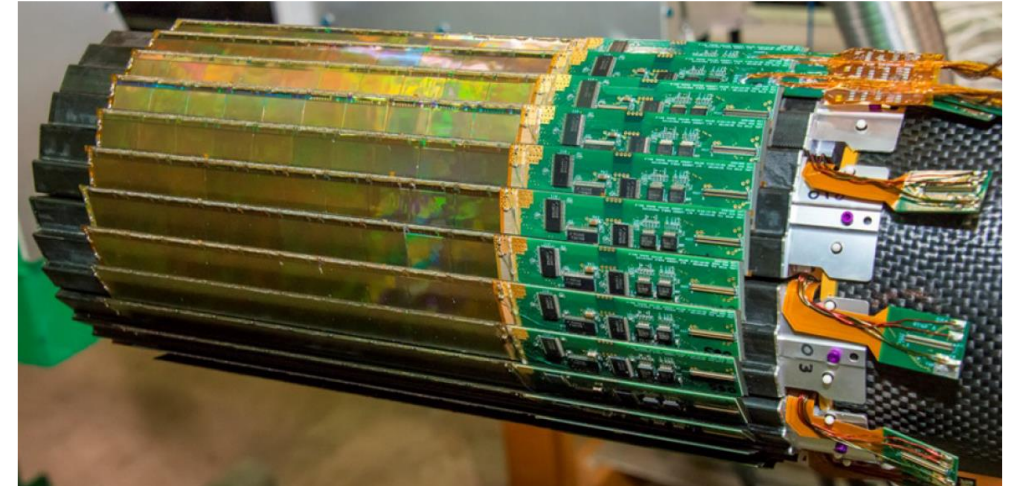

Sensor survey

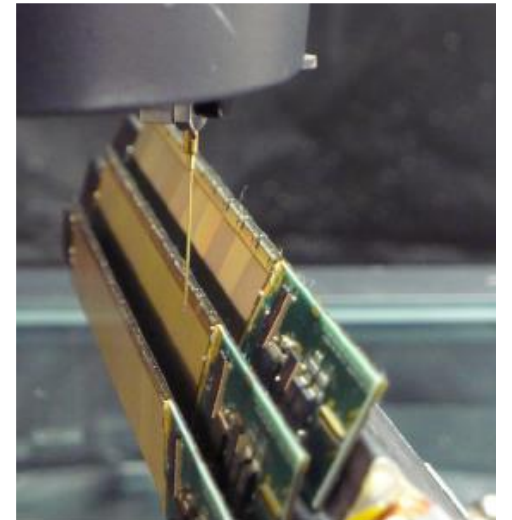

Case study: extremely low mass – Mu3e

- Ultra-low mass ($0.1\%X_0/\text{layer}$)
- Support structure made from folded Kapton
 - Structural stiffness achieved by linking adjacent ladders to modules, which increases area moment of inertia
- Electrical connection: Kapton/Al High Density Interconnect with tab bonding
- He gas flow cooling

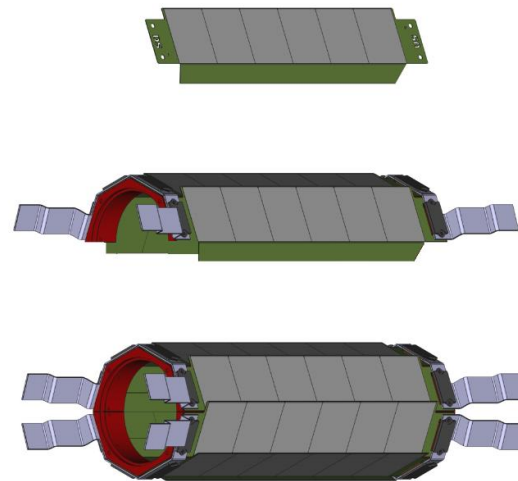
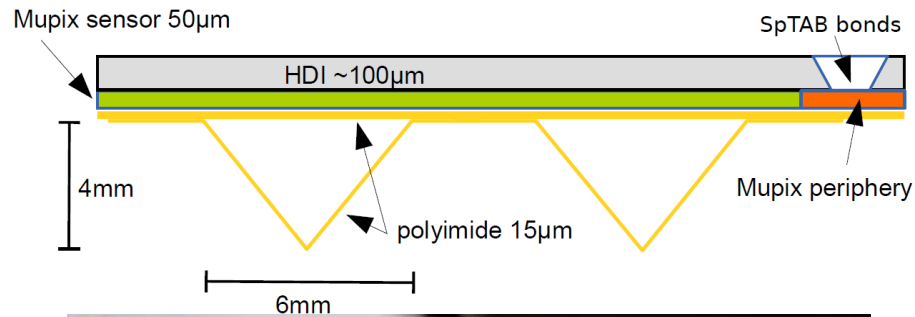

Ladder

Module

Layer

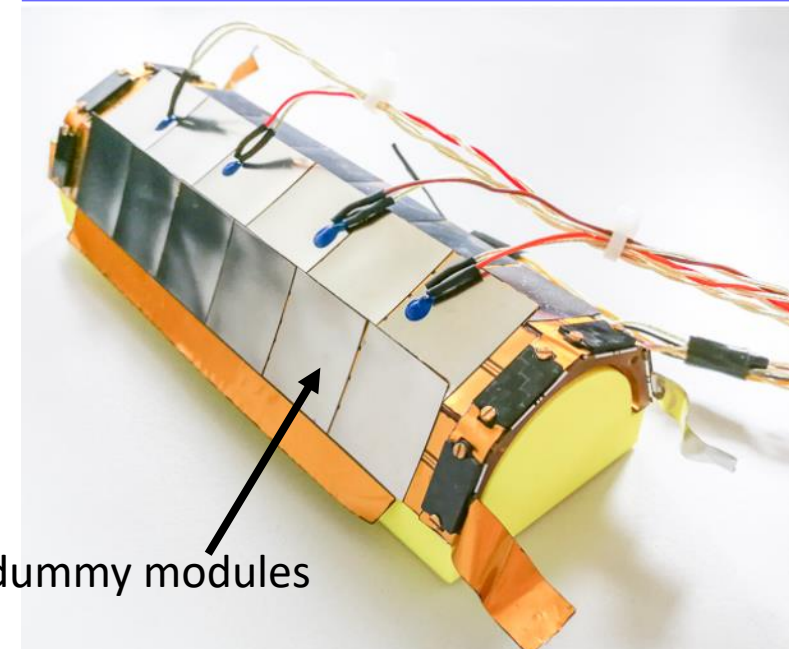
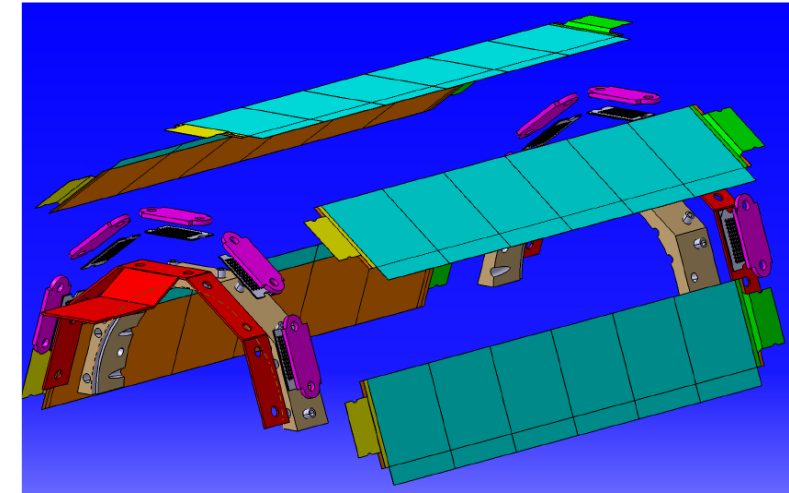

Steel dummy modules

Summary

- The displacement response to external vibration can be described reasonably well with a 1D oscillator with the same resonance frequency as the structure's 1st mode
 - This is because higher modes are usually in the damping tail of the first mode
 - Numerically, this allows for the use of Miles' equation to make a quick prediction
 - This needs to be verified experimentally to capture the performance of joints and more complex mode structures due to the true 3D geometry
- The critical parameter is the bending stiffness EI
 - E is the modulus of the load-bearing elements (material property)
 - I the area moment of inertia (geometry)
- To increase the latter structure should open up
 - Need to watch buckling stiffness
- Modern structures integrate services for material-efficient systems
 - Integration introduces thermo-mechanical challenges

Final thoughts – why we are often bad engineers

- Courtesy Steve McMahon: Physicists are problem-solvers, not problem-avoiders
 - We much rather get all excited when something does not work, and try to find a solution, than spend time in advance to make sure that the problem never shows up
 - When a problem shows up during commissioning suddenly an army of headless chickens will have opinions and run around to find a solution – the same people would have done a much better job early on if they would have prepared properly
- We get intoxicated by cool ideas
 - Often we start with a cool solution, and use that to retro-actively justify the requirements
- We do not like to follow boring procedural schemas
 - Should be: requirements → specifications → design → verification (hardware & software) → build → quality control
 - Our sequence is: design → some prototyping (cool) → wait a minute: we should write down requirements & specs (mix them, it's too late anyway) → build (boring) - no time for quality control, because we are late
- We intimidate our trained engineers and technicians
 - They still believe we are smarter and know things they don't know, and do not dare to tell us we are wrong (although privately they are appalled)
- We don't know the physics
 - Engineering is nothing but applying basic physics (Mechanics, thermal physics, E&M), but we are too lazy/have forgotten too much/have never learned to apply what we learned in our first years at Uni
- Mechanics is not considered sexy
 - Too few are working on this – but we have tons of people working on sensors...