

Development of the BCM' system for beam abort and luminosity monitoring in ATLAS based on a segmented polycrystalline CVD diamond system and dedicated front-end ASIC

Presented by: **Miha Mali**, Jožef Stefan Institute, on behalf of the BCM' group (miha.mali@ijs.si)

ATLAS, LHC and ITk [1] will receive major upgrades in the coming years which will allow:

- Up to 200 p-p interactions per bunch crossing.
- Increased $\sqrt{s} = 14$ TeV.
- Even harsher radiation environment.

Beam Conditions Monitoring Prime detector for beam abort and luminosity measurements:

- Part of the new ATLAS ITk, similar in operating principle to BCM [2].
- Two detector rings mounted symmetrically at ± 1.9 m from interaction point.
- Four detector stations on each ring with a 3D pCVD diamond detector, two planar pCVD diamond detectors and one silicon detector for luminosity measurements per station. Each detector station will also have a single planar pCVD diamond detector for abort functionality.
- Background events selected based on Time-Of-Flight measurement.

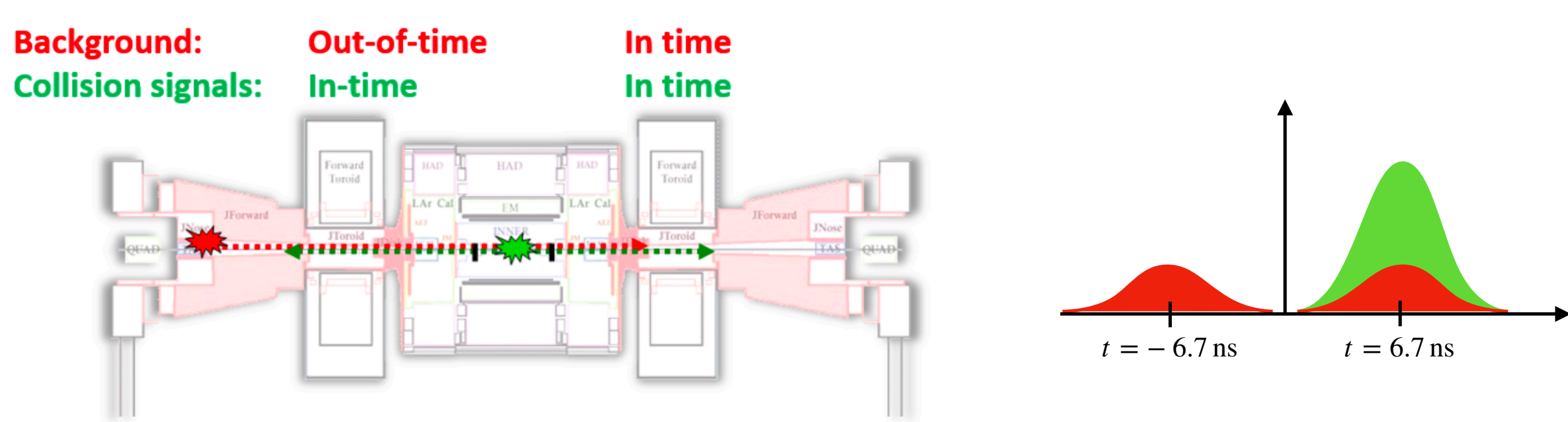

Out-of-time events indicate possible beam instabilities. Abort conditions are met if 3 out of 4 detector stations on each ring trigger in two consecutive beam orbits.

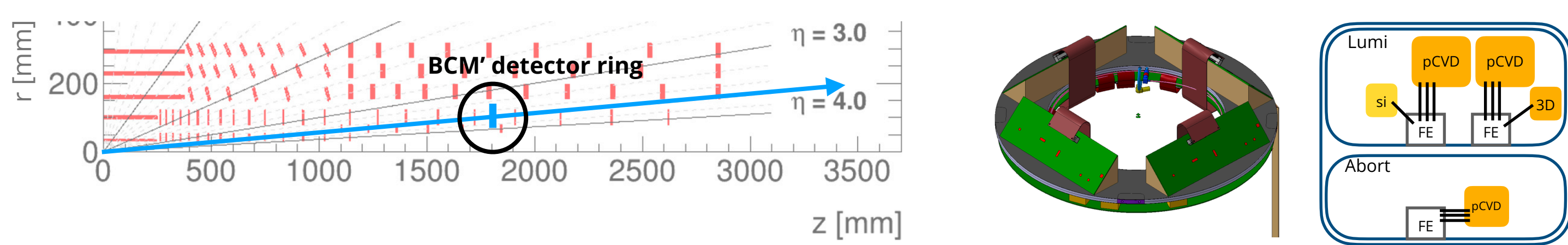

Location of the BCM' ring close to the beam pipe will result in high particle flux up to 230 MHz/cm² and total ionising dose of 3 MGy over the course of operation.

Current design of the BCM' ring with supports for four inclined detector stations and a sketch of sensors on the detector station.

BCM' readout chain:

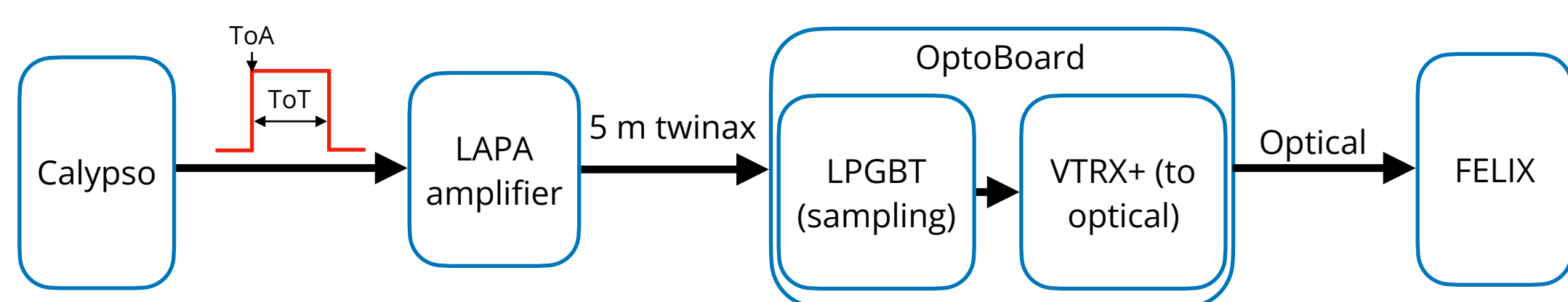

LVDS signals from Calypso are first amplified by LAPA and digitized at 1.28 Gbps by LpGBT. FELIX readout hardware receives optical signal and applies luminosity and abort algorithms and distributes output signal to ATLAS control systems.

CERN SPS H6A test beam setup:

- Detector module boxes used for testing pCVD diamond sensors and Calypso FE ASIC.
- MALTA pixel detectors used for the tracking telescope [3].
- Beam with 120 GeV pions used to simulate minimum ionising particles.
- Keithley K2410 source measure unit used for applying up to ± 1000 V to pCVD diamond sensor.
- Three DRS4 oscilloscopes used to record analog and LVDS outputs from Calypso FE.

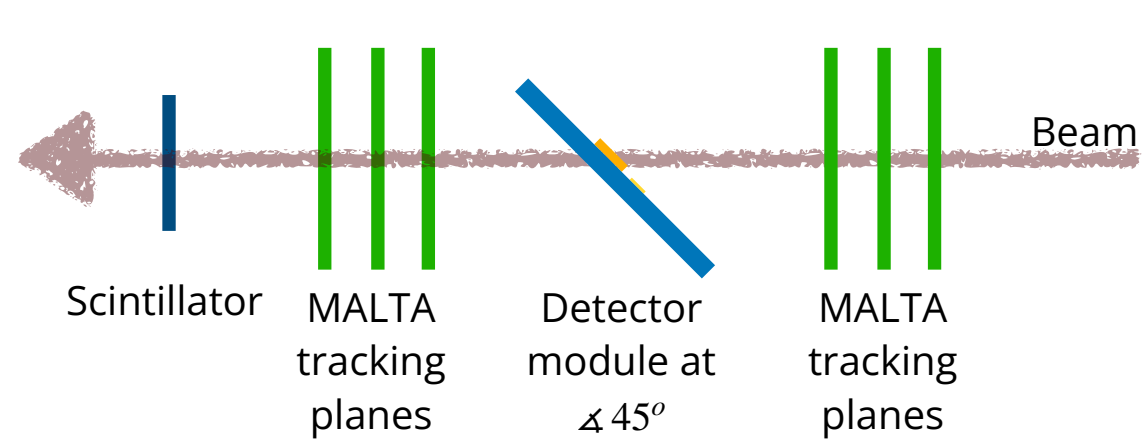

MALTA telescope uses 6 tracking planes which give the reconstructed track spatial resolution of $4.1 \mu\text{m}$ and reconstructed track timing resolution of 2.1 ns.



Detector module box with a $10 \times 10 \text{ mm}^2$ pCVD diamond and Calypso FE ver. C.

Track reconstruction quality cuts:

- Only 1 track in the telescope, fiducial region set within the detector.
- Reconstruction quality cut on track χ^2 score and track slope. A loose timing cut within ± 10 ns on first 3 MALTA planes.
- Tracking cuts discard $\sim 50\%$ of recorded data.

pCVD diamonds selected for main detector material:

- Insulator at room temperature, no cooling required.
- High electric field of up to $2 \text{ V}/\mu\text{m}$ produces fast signals.
- Suitable for high radiation environments [4].

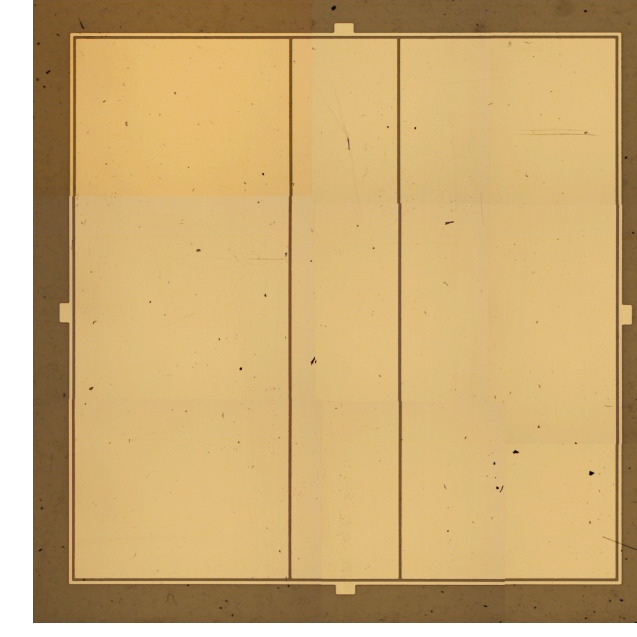

A planar $10 \times 10 \text{ mm}^2$ pCVD diamond segmented into pads with ratios 6:3:6. Two such detectors will be used for luminosity measurements on each detector station. A planar segmented $5 \times 5 \text{ mm}^2$ pCVD diamond on each detector station will be used for abort functionality. Detectors will be $500 \mu\text{m}$ thick and inclined at 45° with respect to the beam to increase particle ionisation path.

Calypso FE ASIC [5] for radiation hard-environment:

- Four channels, each FE amplifier and CFD configurable separately.
- Abort ($8.2 \text{ mV}/\text{fC}$ FE gain) or Lumi ($60 \text{ mV}/\text{fC}$ FE gain) functionality.
- 1 ns rise-time, 100 ps jitter, 200 e⁻ noise for 2 pF detector capacitance.
- Outputs a LVDS signal with ToA and ToT information for each channel.
- Full feature design with increased 256 step of CFD threshold range, internal pulser, I²C addressing and bandgap voltage reference submitted.

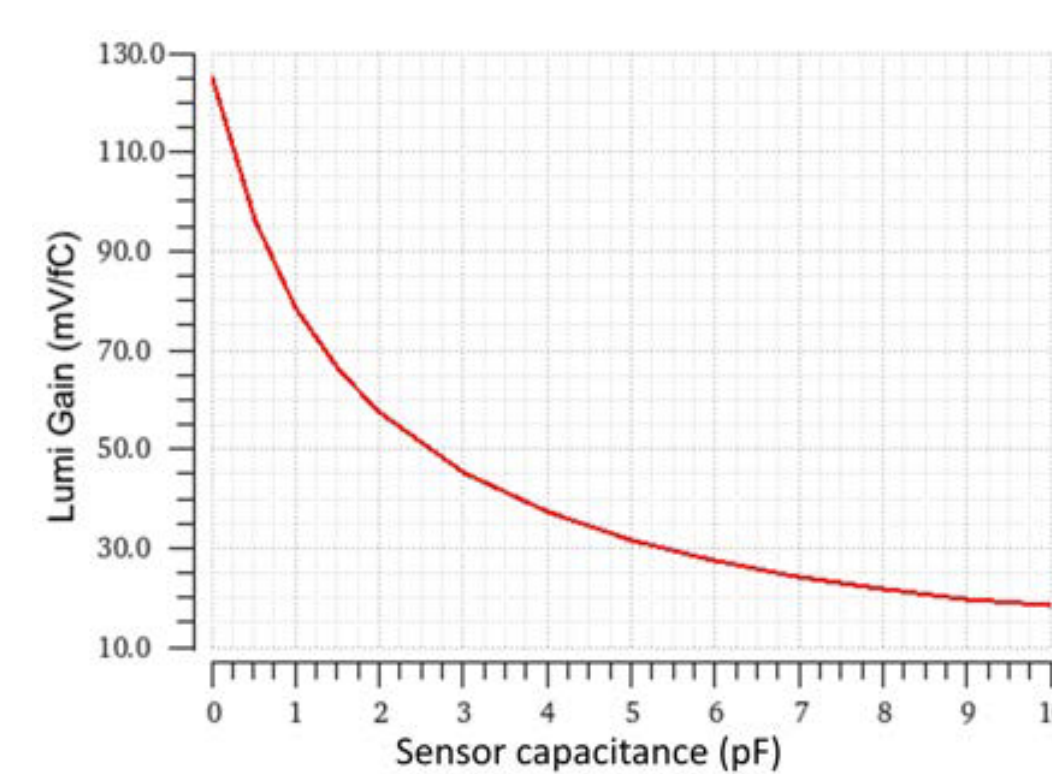

Simulated gain of the Calypso FE amplifier for different sensor capacitances.

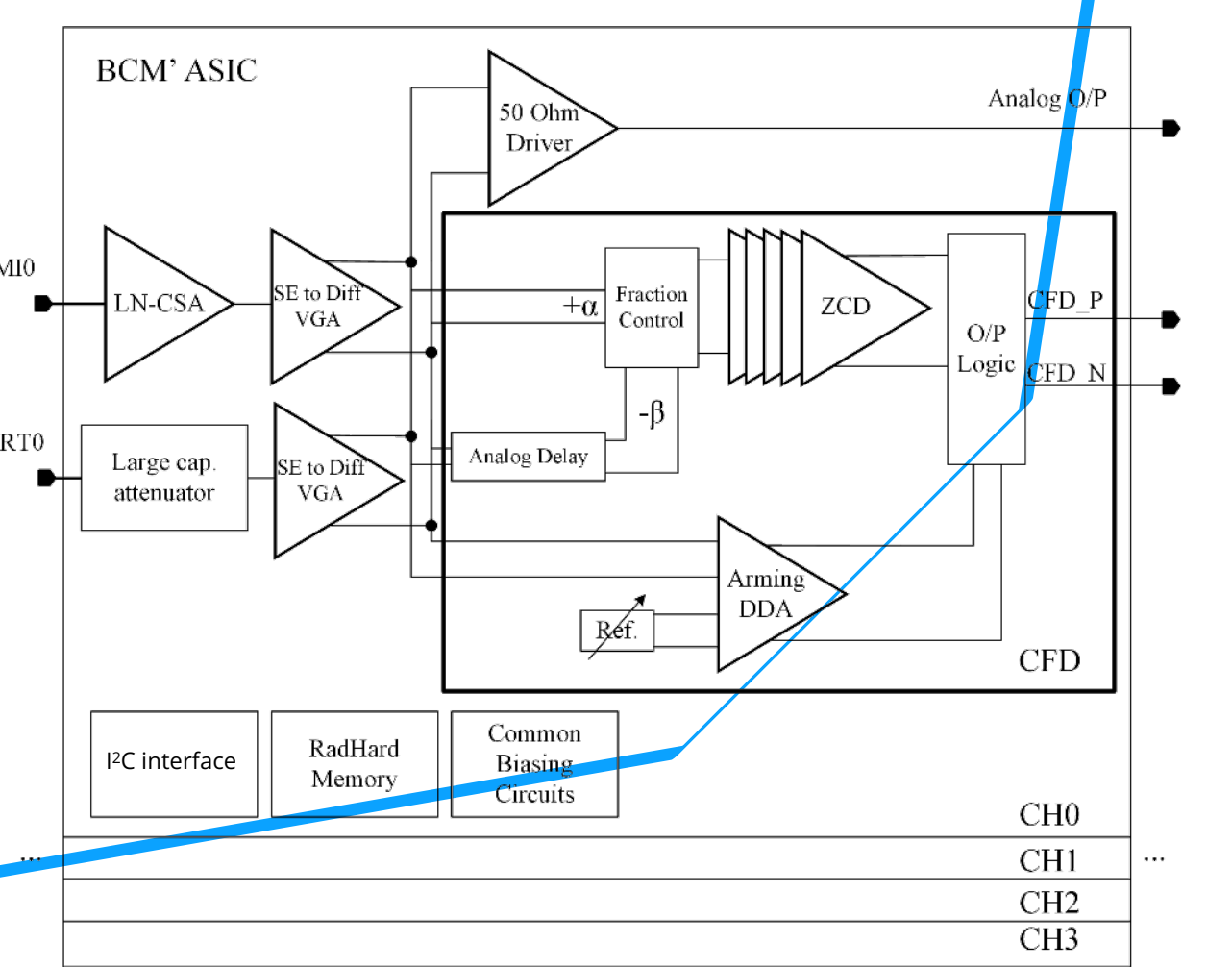

Latest pCVD diamond and Calypso FE test beam results:

- Multiple test beam campaigns in the last 2 years.
- Tested multiple detectors from different wafers with various pad geometry, metalization and different bias voltage polarities [6].

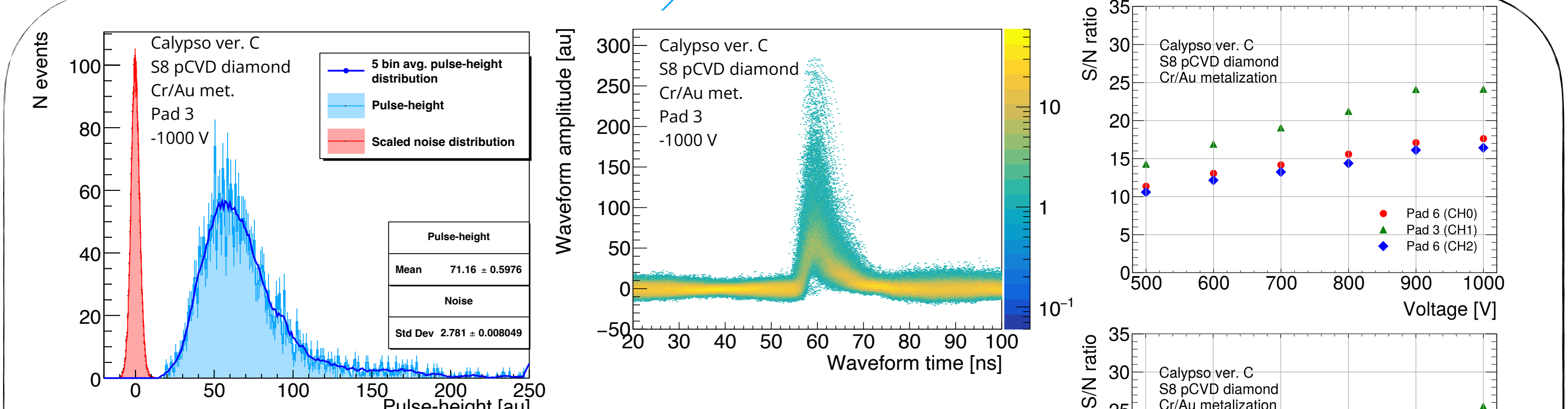

Analog output signal to noise ratio of 25 measured for Pad 3 at bias voltage of ± 1000 V. The system can reliably achieve S/N ratio > 20 at ± 800 V bias voltages.

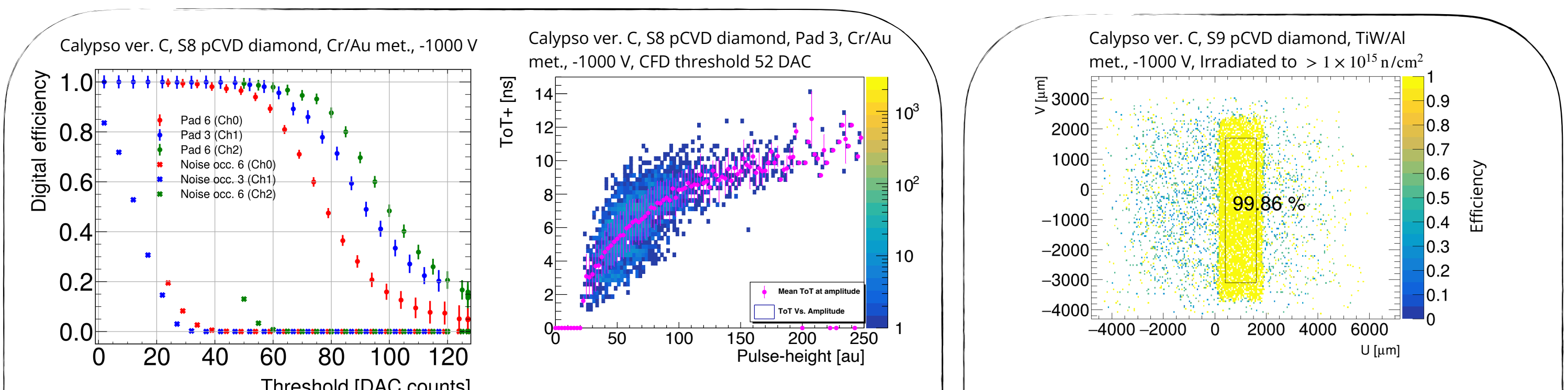

Threshold scan shows Calypso ASIC can be run at variable efficiency and low noise occupancy for all three tested detector channels. The Calypso ASIC ver. C tested here featured a smaller range of 128 CFD threshold steps of ~ 100 e⁻ per step. For each individual threshold setting we measured the expected distribution of ToT vs. pulse-height for events triggered by the CFD.

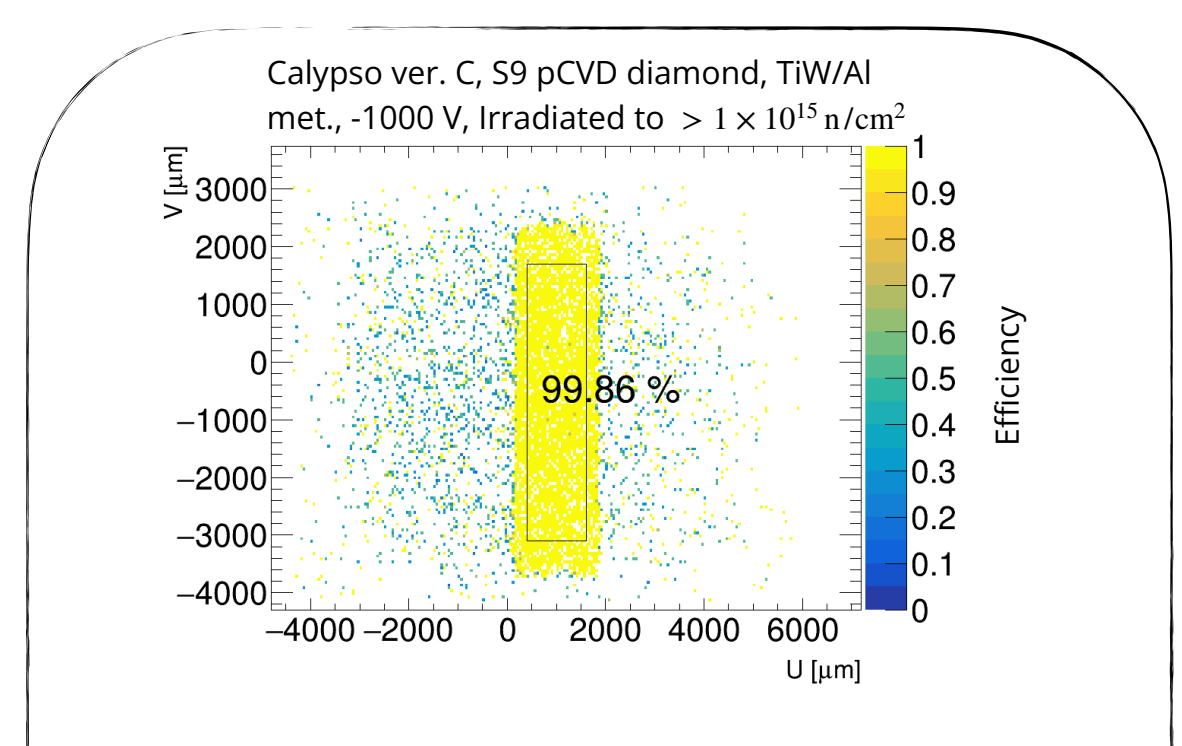

One detector was tested after irradiation at JSI TRIGA reactor. RIE-ICP surface processing and a TiW/Al metalization was done afterwards. Measurements showed a high detection efficiency for MIP particles at 5σ separation.

References:

- [1] Technical Design Report for the ATLAS Inner Tracker Pixel Detector, Tech. Rep. (CERN, Geneva, 2017).
- [2] V. Cindro et al., The ATLAS Beam Conditions Monitor, Journal of Instrumentation **3** (02), P02004.
- [3] M. van Rijnbach et al., Performance of the MALTA telescope, The European Physical Journal C **83**, 10.1140/epjc/s10052-023-11760-z (2023).
- [4] L. Băni et al., Radiation tolerance of diamond detectors, Journal of Physics: Conference Series **2374**, 012172 (2022).
- [5] M. Mansour et al., A Fast, Low-Jitter, and Low-Time-Walk Multi-Channel Front-End IC for Diamond and Silicon Radiation Detectors, IEEE Transactions on Nuclear Science **70**, 1514 (2023).
- [6] A. Gorišek, Development of the BCM' System for Beam Abort and Luminosity Monitoring at the HL-LHC, in Proceedings of 10th International Workshop on Semiconductor Pixel Detectors for Particles and Imaging — PoS(Pixel2022)040 (Sissa Medialab, 2023).