

Large area tiles of Position-Sensitive Silicon Photomultipliers

Fabio Acerbi^a, S. Merzi^a, A. Gola^a

^a Fondazione Bruno Kessler (FBK), Center for Sensors and Devices, Trento, Italy.

acerbi@fbk.eu

Photodetectors → SPAD & Silicon Photomultipliers (SiPM)

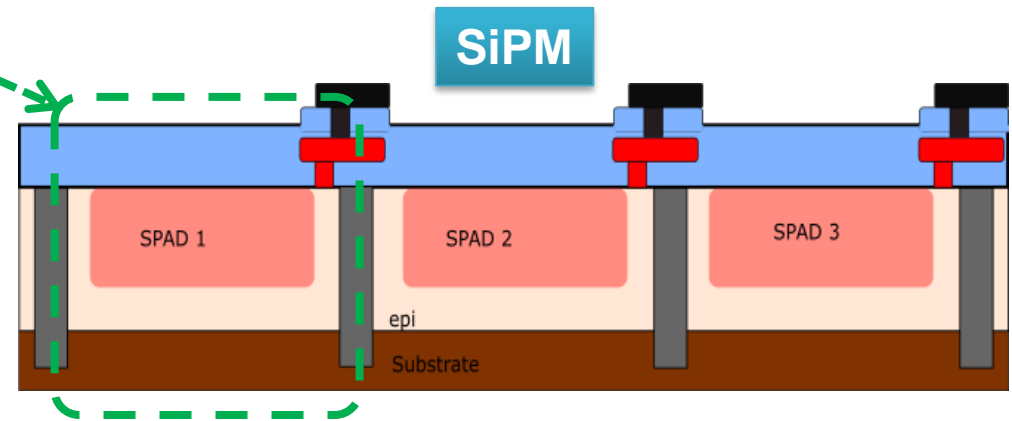
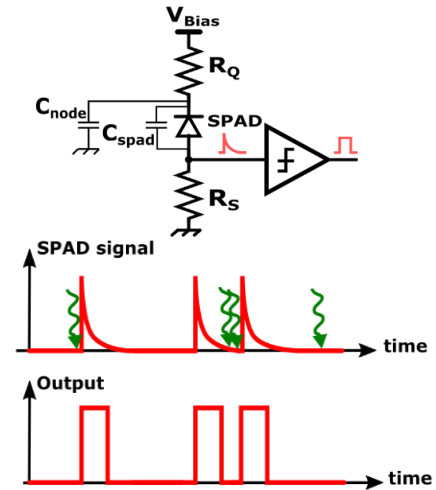
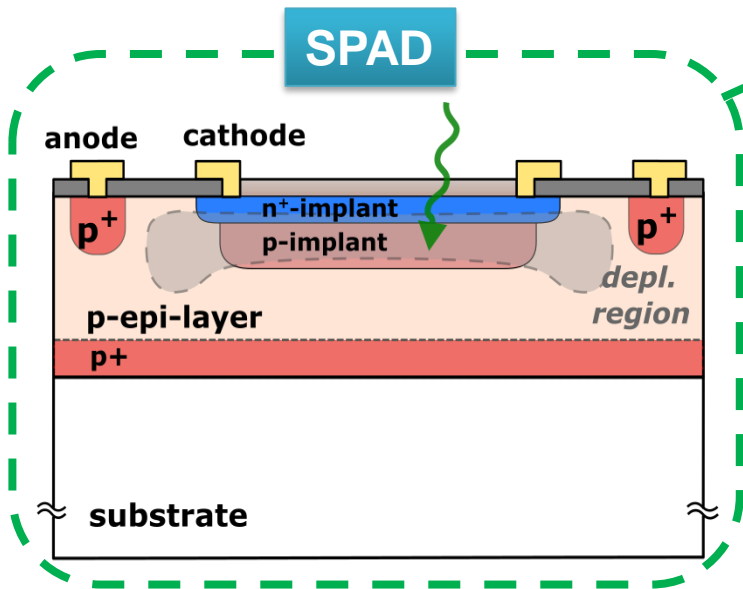
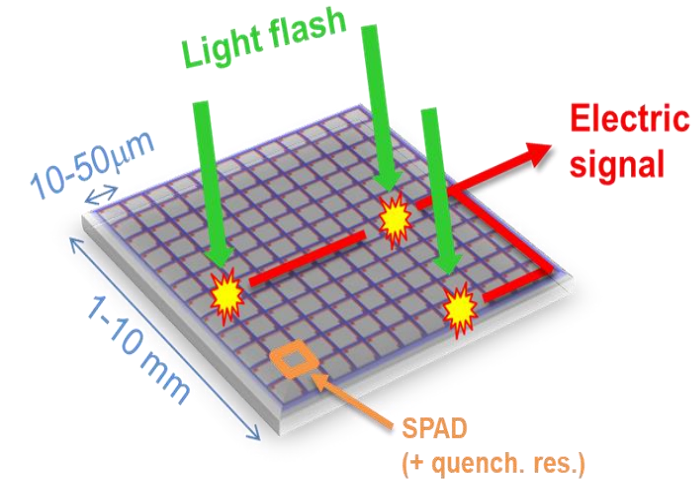
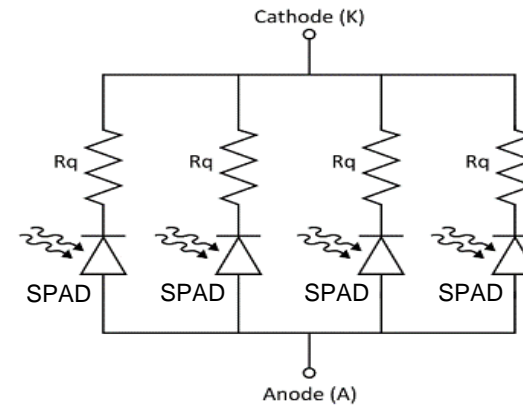
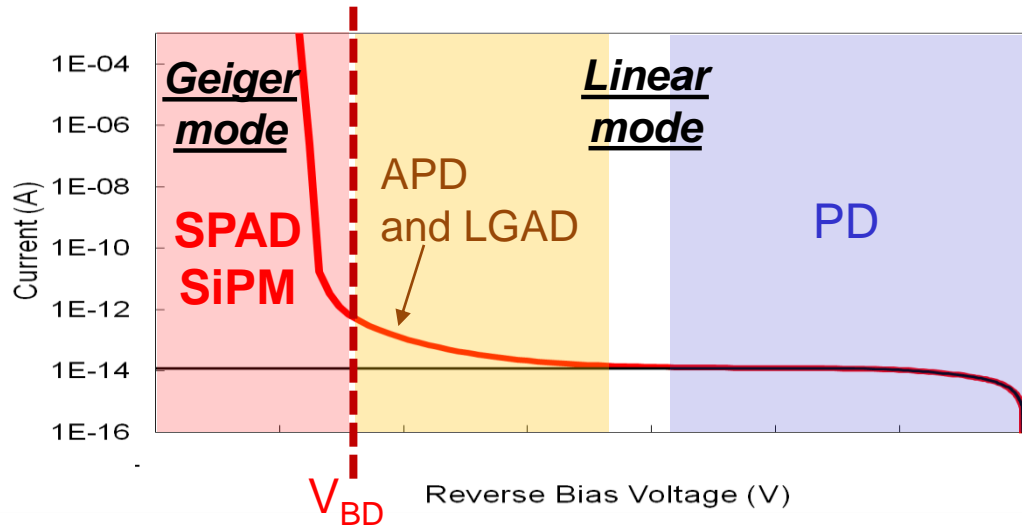

SiPM: (analog) Silicon photomultiplier → thousands of SPADs in parallel

Silicon Photomultipliers (SiPMs)

- Silicon Photomultiplier (SiPM): large-area, solid-state, single-photon sensitive detectors, with ph.-number resolution, and large dynamic range.
- Applications: medical imaging, high-energy physics, biotech, LiDAR, diffuse optics, others.
- Active areas: 1x1 mm² up to 10x10 mm²

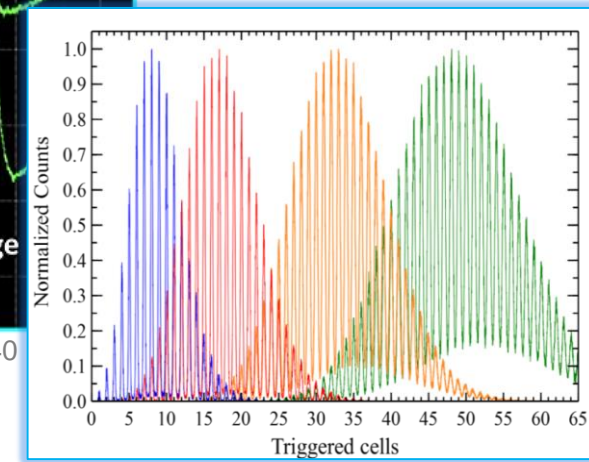
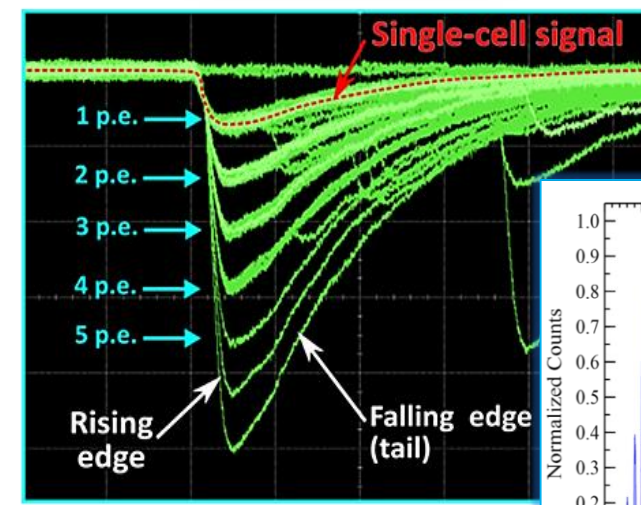
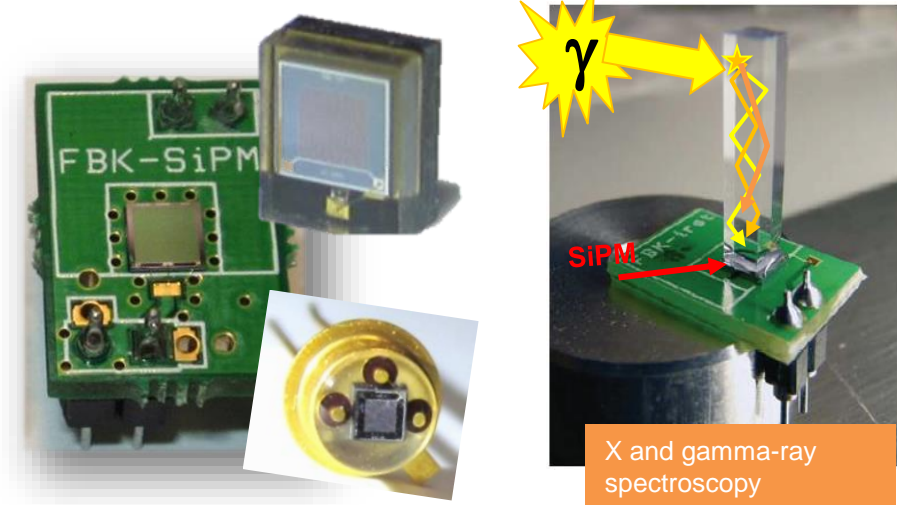

FBK SiPMs technologies

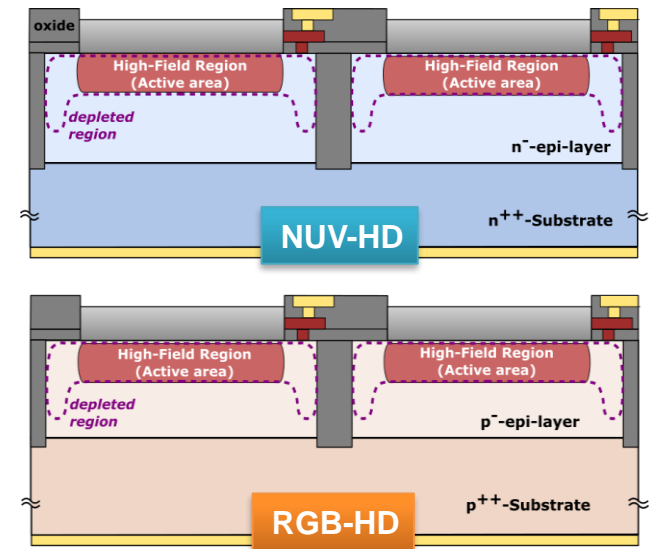
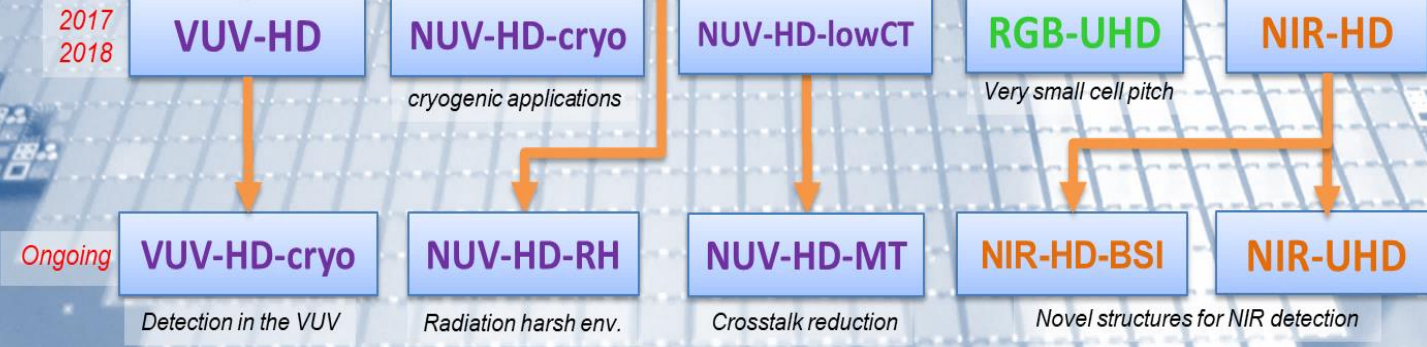
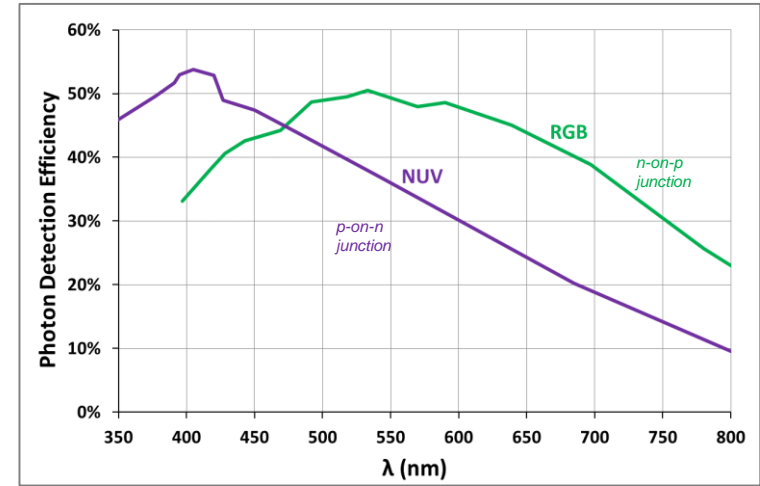
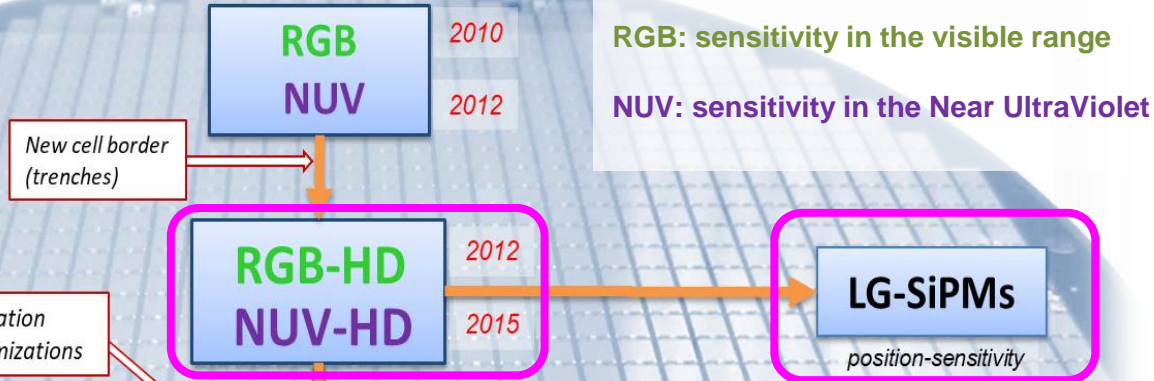

Many different SiPM technologies, tailored for different applications

SiPM: large areas & pos. resolution

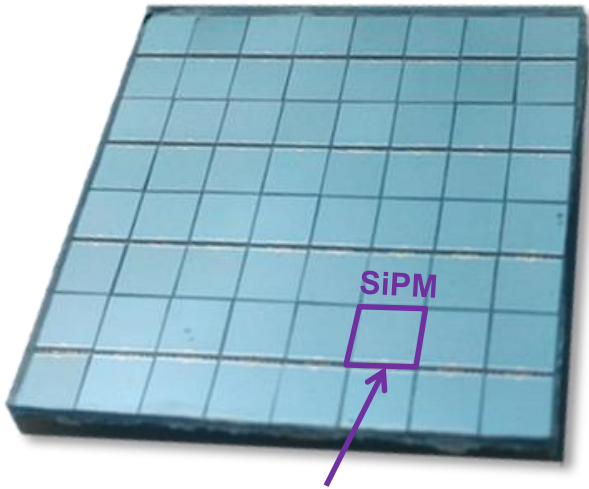

1 SiPM: 1 output
(chip size: 1÷4mm)
(pos. res.: 1÷4mm)

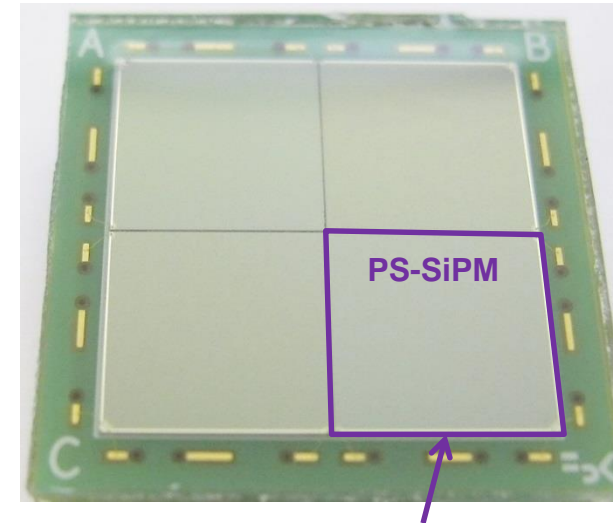
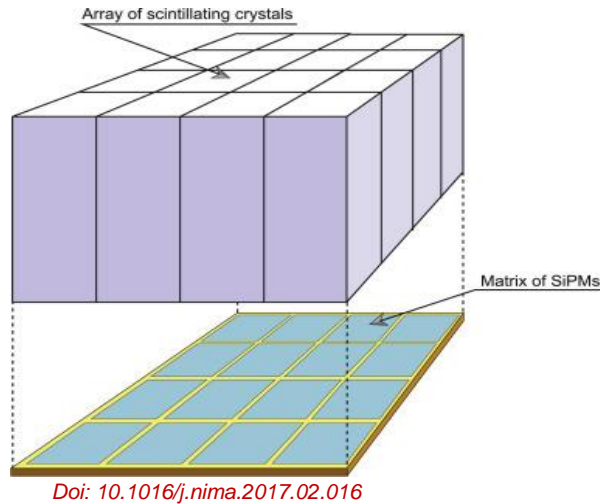

1 SiPM: 4 output
(chip size: 8÷10mm)
(pos. res.: <0.5mm)

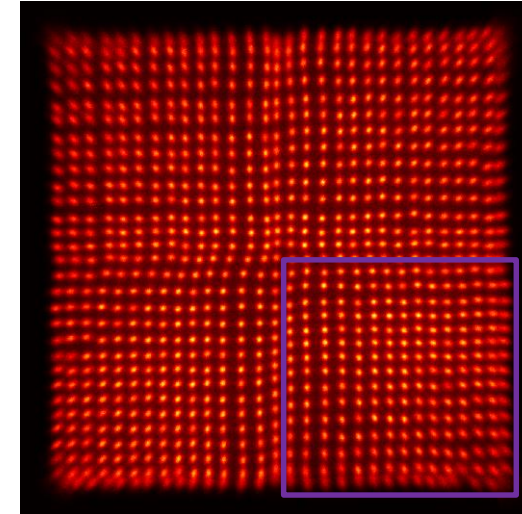

SiPM array

- Small/med. size chips (no pos. resolution)
 - Array position resolution: ~ chip size
- Many output channels (e.g. 8x8)
- Typ. ASIC readout (64 channels)

Position-sensitive (PS) SiPM

- Large area chips with position resolution (<0.5mm)
- Reduced number of channels.
 - Further #channels reduction techniques.
- *Slightly complex production process.*

SiPM: large areas coverage

SiPM array

Application: PET, SPECT, ...

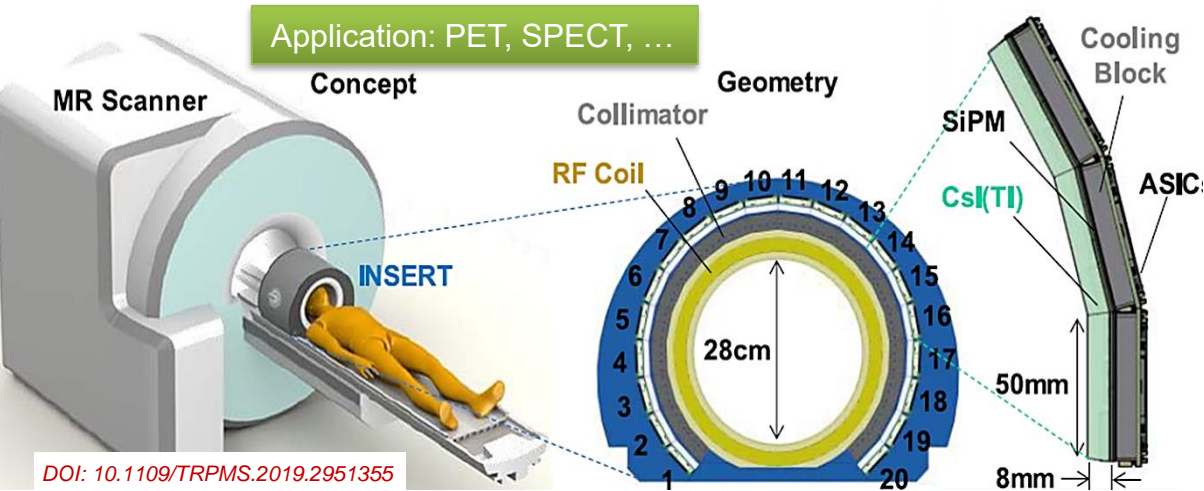

Position-sensitive (PS) SiPM

Application: small-animal PET

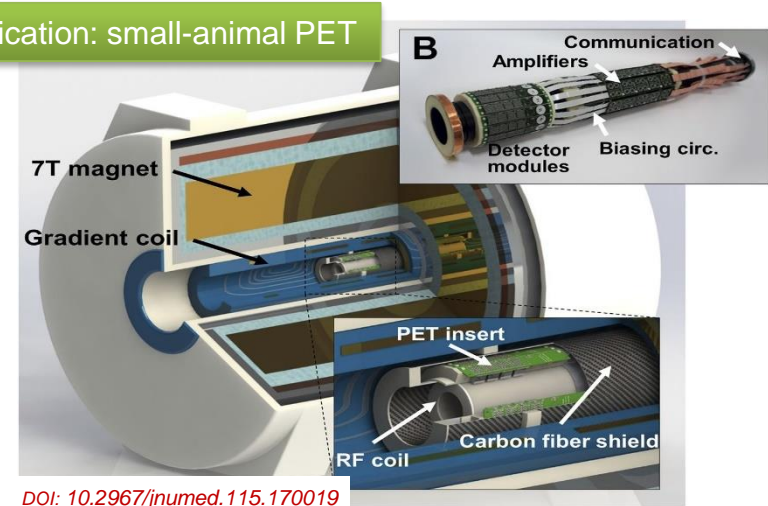

Application: γ -ray det. modules for space experiments

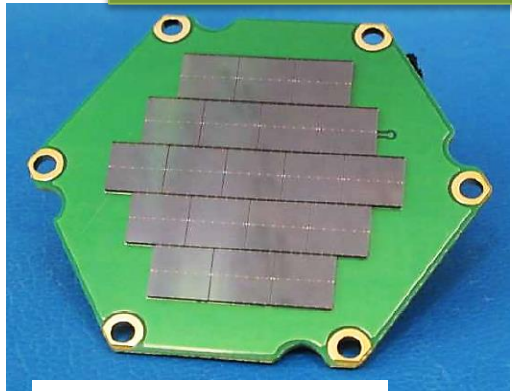

Application: TPC readout

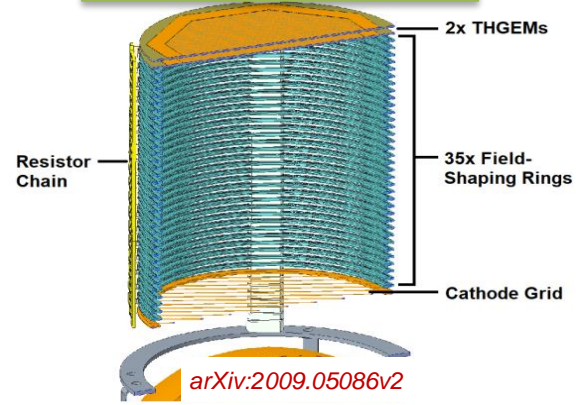

Application: compact γ cameras



Position sensitive SiPM technologies

(1) SeSP

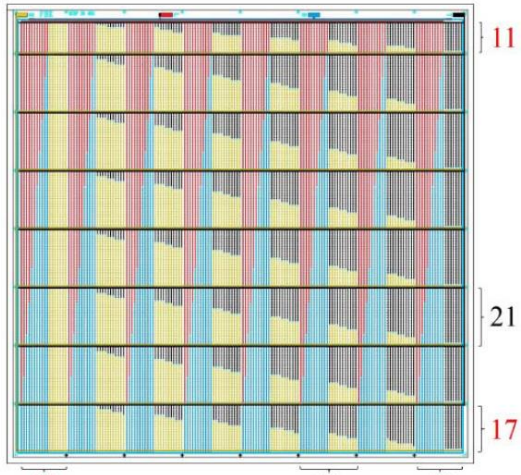

[1] Omidvari, N. and V. Schulz, IEEE Transactions on Nuclear Science, 2015. 62(3): p. 679-687.

- “Sensitivity-encoding” or “interpolating” position-sensitive SiPM
- Based on scintillation light-sharing among micro-cells or SiPM regions
- Scaling: not straightforward

(2) i-SiPM

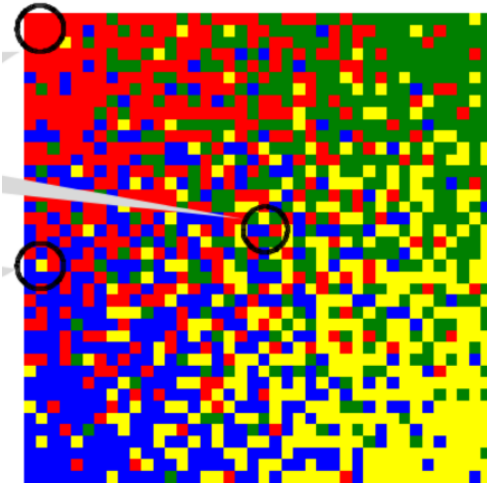

[2] I., S., et al. IEEE SENSORS. 2013.

(3) Resistive-network

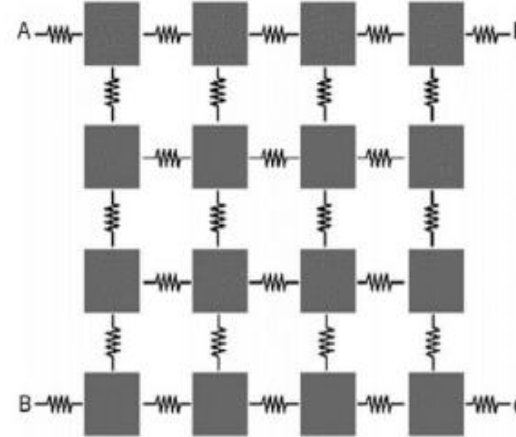

[3] J., P.S., et al., IEEE Transactions on Nuclear Science, 2014. 61(3): p. 1074-1083.

- Based on resistive-network
- Parasitic effects / signal shape might depend on SiPMs size
- Scaling: difficult

(4) EQR Tetra-Lateral PS SiPM

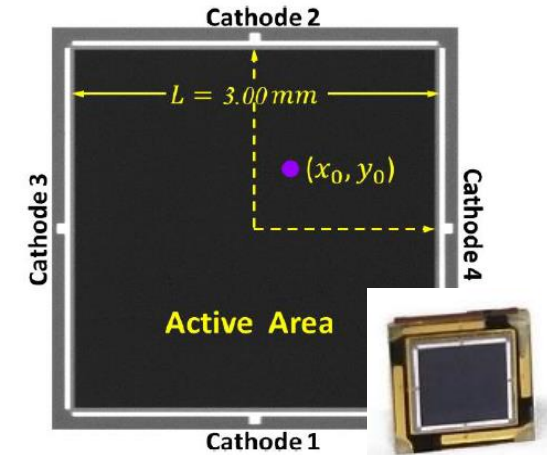

[5] Zhao, T., et al., IEEE Electron Device Letters, 2017. 38(2): p. 228-231.

- Based on common cathode and epitaxial quenching resistor (EQR)
- Limited freedom in cell-pitch and SiPM dimension
- Scaling: not straightforward

FBK approach : Linearly-graded (LG) SiPM

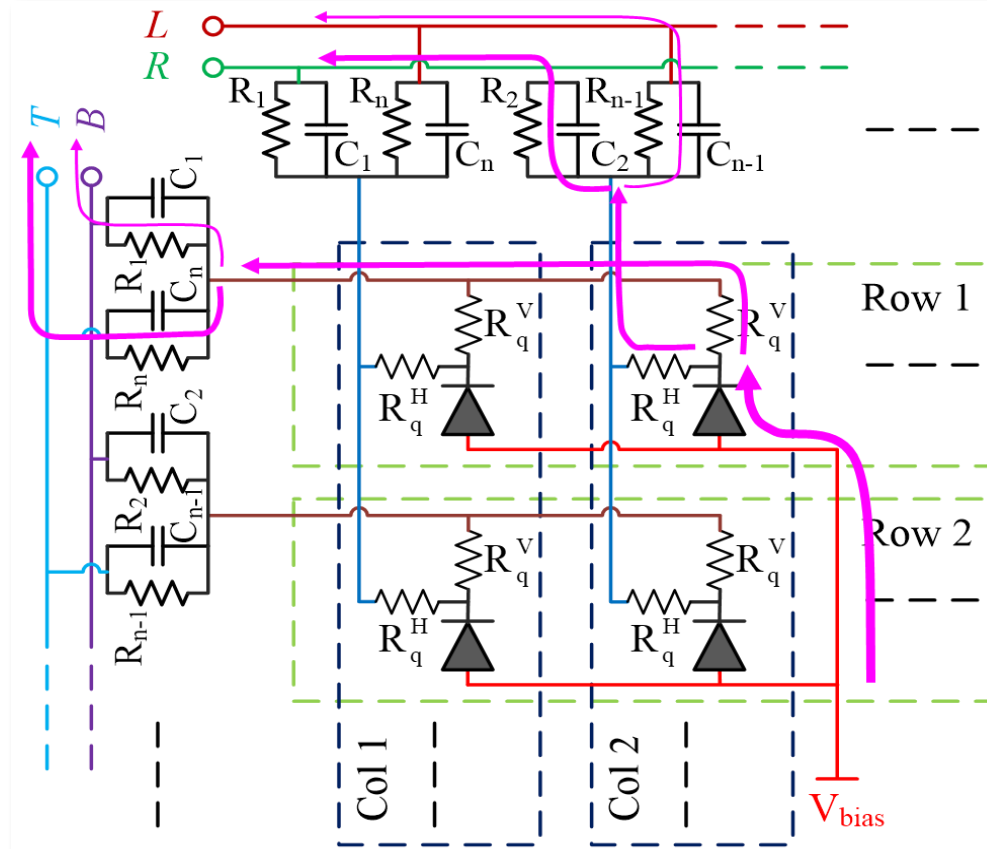
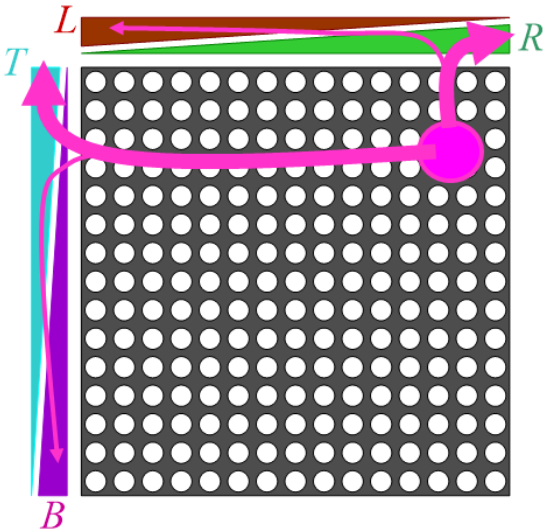
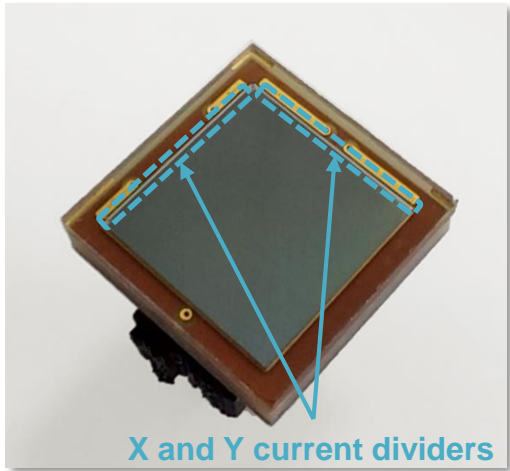

- **Each micro-cell: 2 quenching resistor** connected to **2 current dividers**
- Every column (every row) of cells is connected to the same current divider
- Current split between **2 outputs** for the **vertical** position and **2 outputs** for the **horizontal** position
- Difference between the currents flowing through the two arms (amplitude or total charge) of the divider **changes linearly** with the horizontal and vertical position.

LG-SiPM approach:

- ✓ Based on a charge-sharing method
- ✓ Discretization: almost at the single micro-cell level
- ✓ Highly scalable → large tiles, with very few channels

FBK approach: Linearly-Graded (LG) SiPM

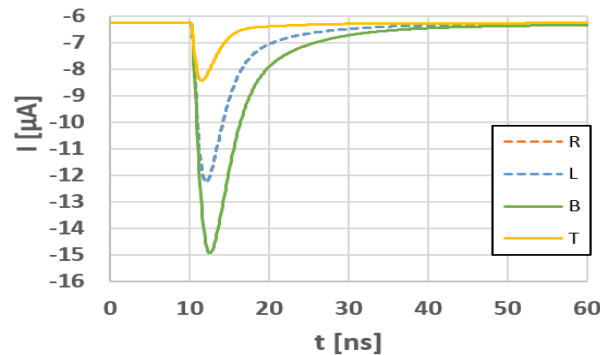
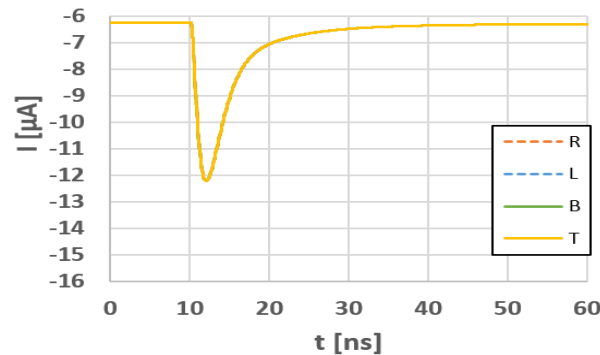
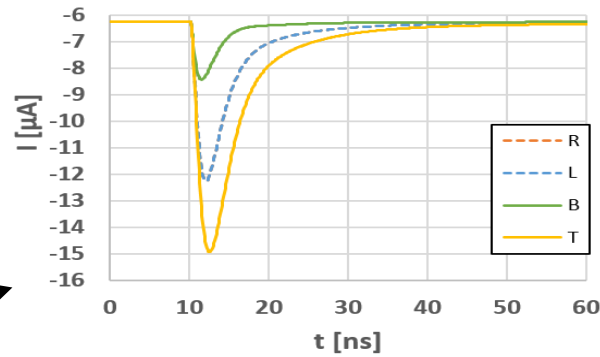
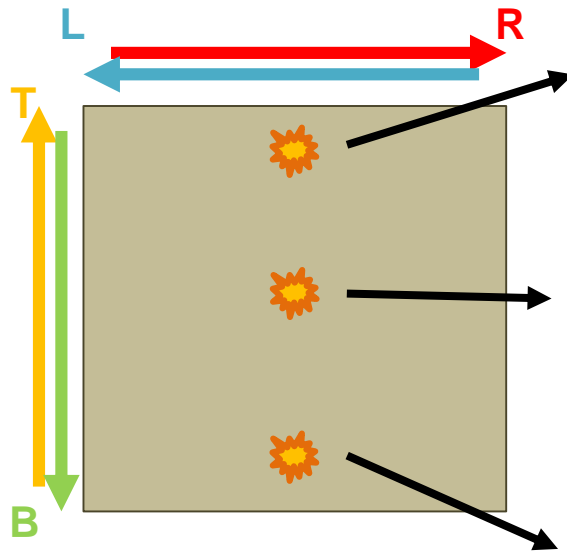

- Single cell signal split into **4 outputs**

$$I_{cell} = I_R + I_L + I_T + I_B$$

- Ratio of the outputs (amplitude and charge) **depend on the position of the triggered cells**

- Event position: reconstructed through **center of mass** calculation:

$$X = \frac{I_R - I_L}{I_R + I_L} \quad Y = \frac{I_T - I_B}{I_T + I_B}$$

- Total event energy: sum of all the signals:

$$E_{event} = E_R + E_L + E_T + E_B$$

Channel reduction configurations

Std SiPM array

20x20 mm²
(pitch 1mm)
Approx. 400 ch.

30x30 mm²
(pitch 1mm)
Approx. 900 ch.

LG-SiPM: Std array readout

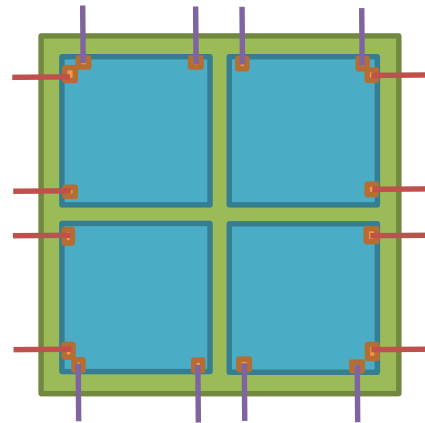

2x2 array

20x20 mm²
16 ch.

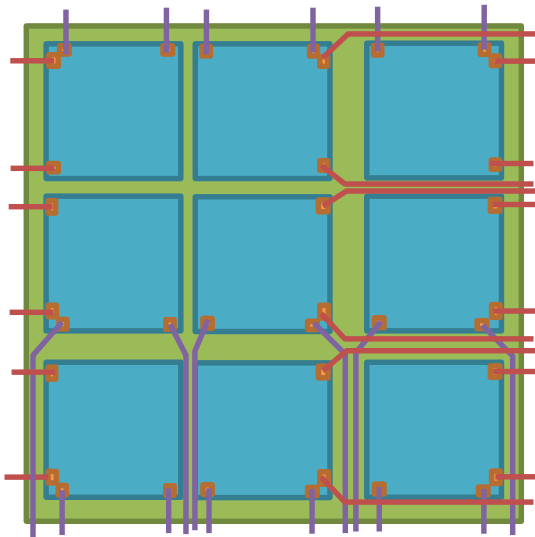

3x3 array

30x30 mm²
36 ch.

LG-SiPM: Advanced #ch-reduction config.

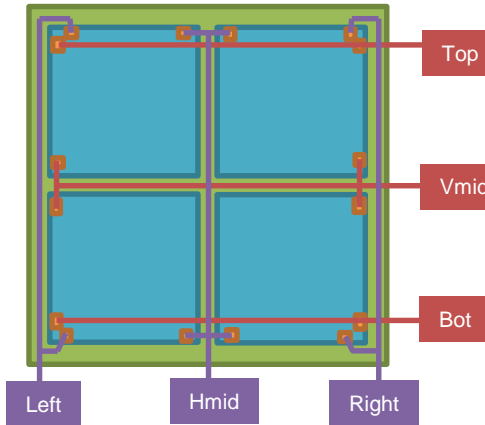

2x2 array

20x20 mm²
6 ch.

*Still with nominal
pos. res. <0.5mm*

$$X = \frac{I_R - I_L}{I_R + I_{Hmid} + I_L}$$

$$Y = \frac{I_T - I_B}{I_T + I_{Vmid} + I_B}$$

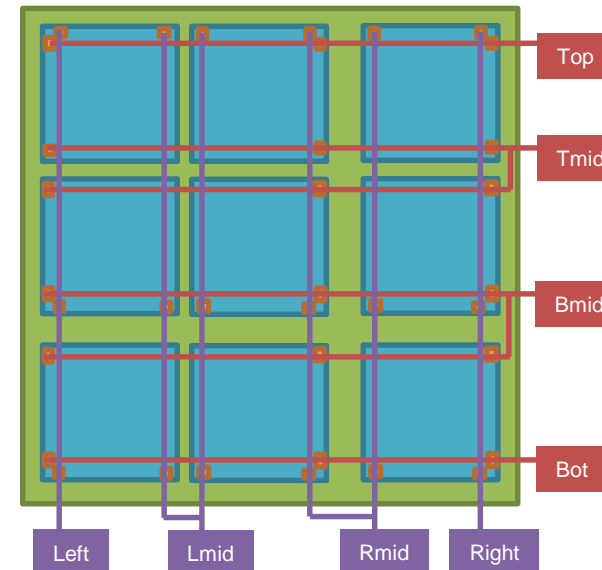

3x3 array

30x30 mm²
8 ch.

*Still with nominal
pos. res. <0.5mm*

$$X = \frac{I_R + 0.33 \cdot I_{Rmid} - 0.33 \cdot I_{Lmid} - I_L}{I_R + I_{Rmid} + I_{Lmid} + I_L}$$

$$Y = \frac{I_T + 0.33 \cdot I_{Tmid} - 0.33 \cdot I_{Bmid} - I_B}{I_T + I_{Tmid} + I_{Bmid} + I_B}$$

FBK approach: Linearly-Graded (LG) SiPM

RGB-HD LG-SiPM

- Chip nom. size: $8 \times 8 \text{ mm}^2$
- Active area: $7.75 \times 7.75 \text{ mm}^2$
- Cell pitch: $20 \mu\text{m}$
- Peak PDE: 550nm
- DCR: $\sim 300 \text{ kcps/mm}^2 @ V_{\text{ex}}=5\text{V}$

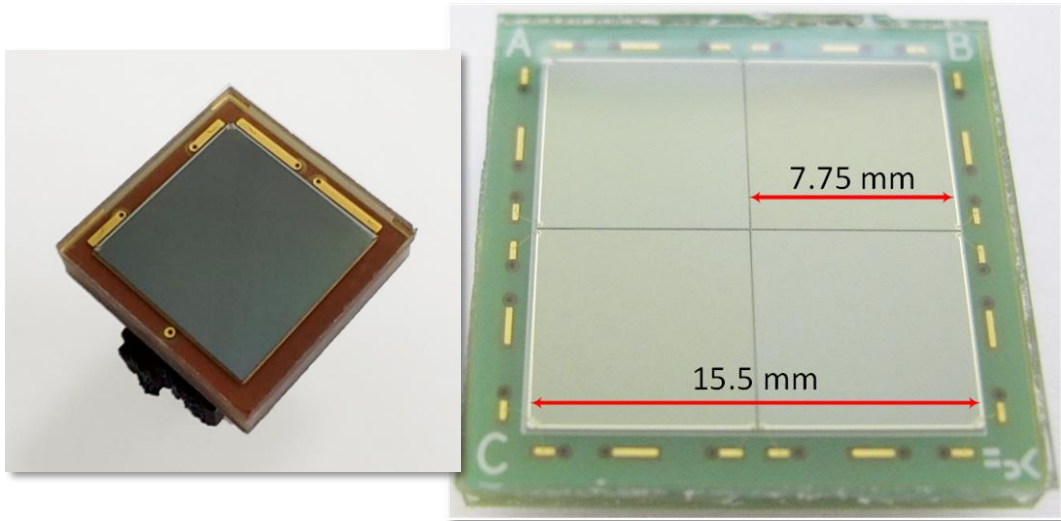

NUV-HD LG-SiPM

- Chip Nom. size: $10 \times 10 \text{ mm}^2$
- Active area: $9.75 \times 9.75 \text{ mm}^2$
- Cell pitch: $25 \mu\text{m}$
- Peak PDE: 420nm
- DCR: $30 \div 60 \text{ kcps/mm}^2 @ V_{\text{ex}}=5\text{V}$

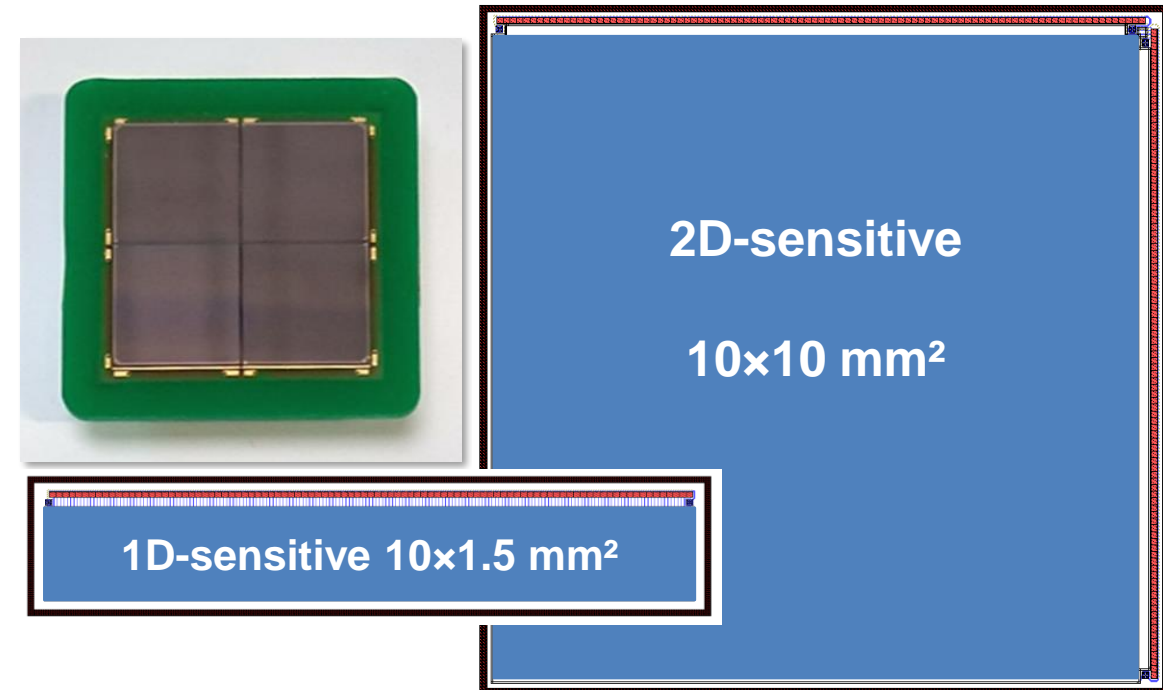

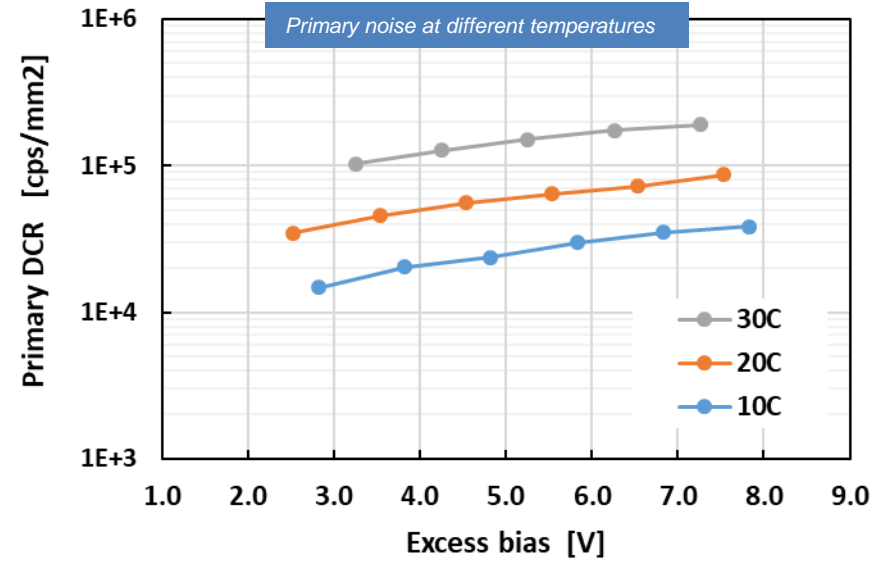
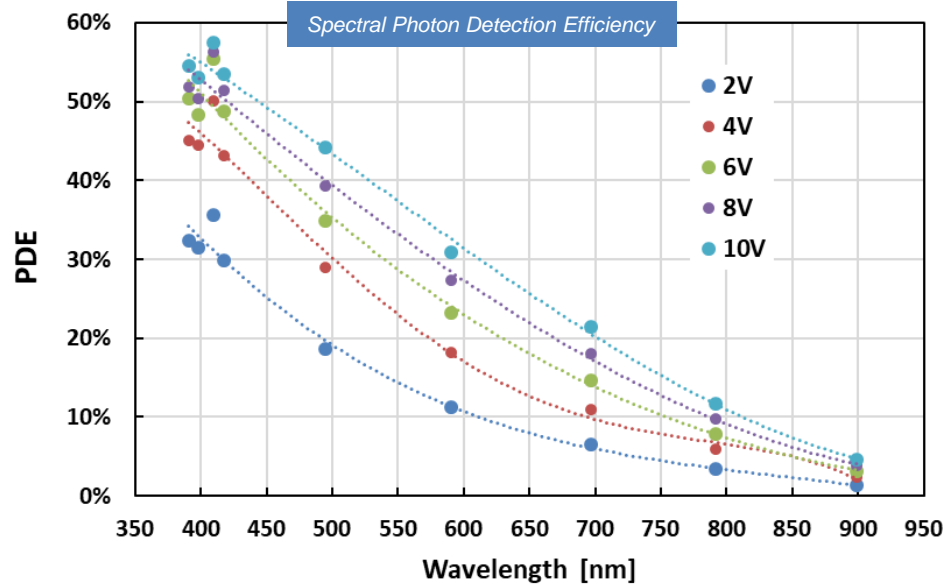

Measured on 1x1mm² SiPMs (at different temperatures) and on LG-SiPM 1D

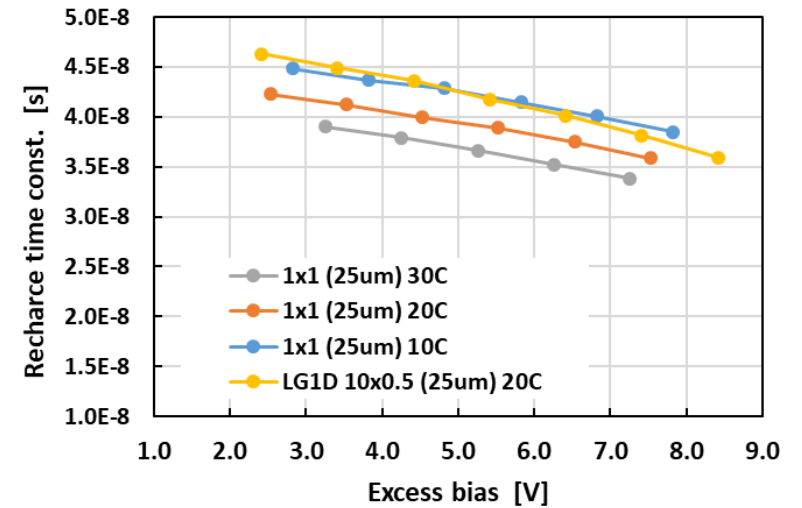
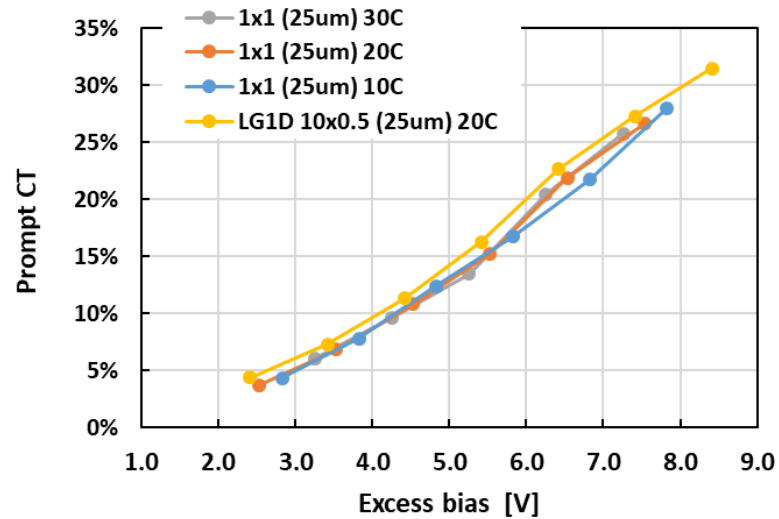
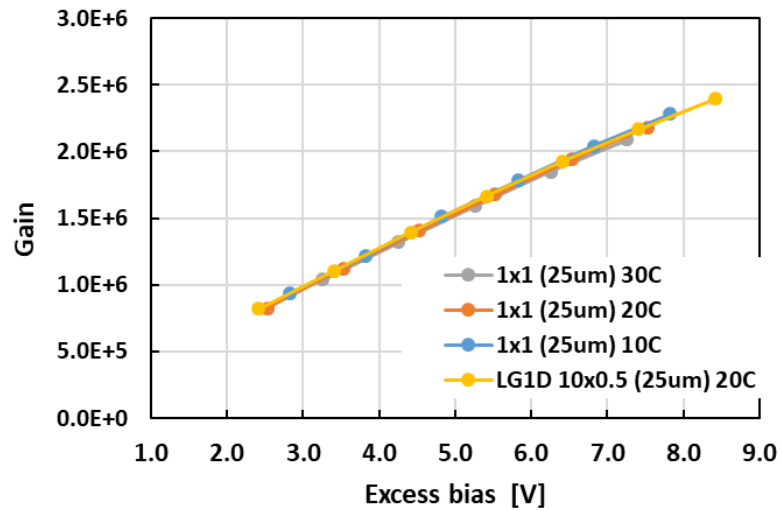

Position resolution tests: setup and devices

Climatic chamber

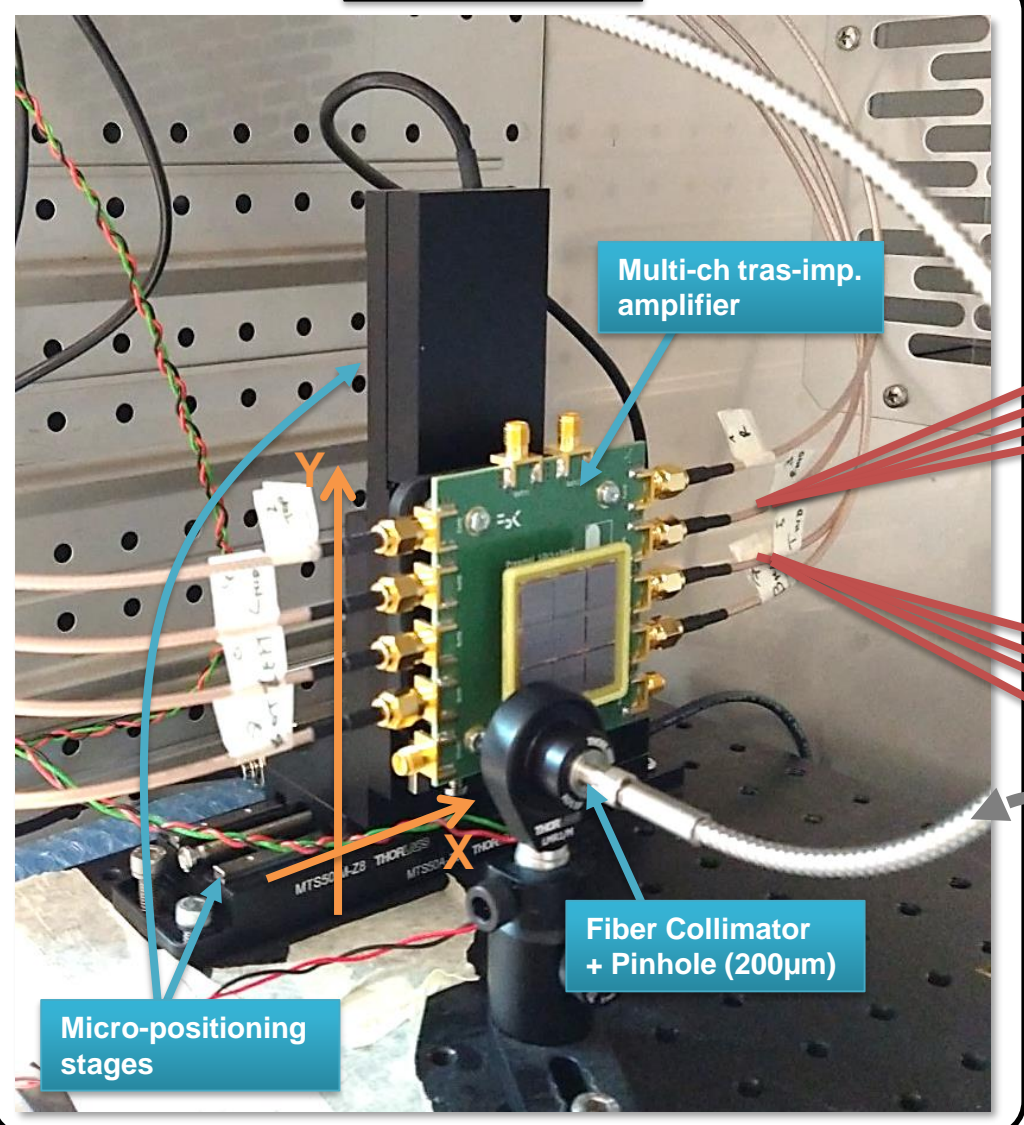

Multi-ch tras-imp. amplifier

Fiber Collimator + Pinhole (200µm)

Micro-positioning stages

#2 Synchronized oscilloscopes



Pulsed LED

sync

1chip (LG-SiPM) 4 ch.

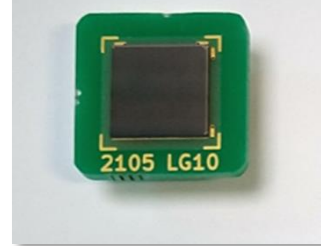

Tile 2x2 (LG-SiPM) 6 ch.

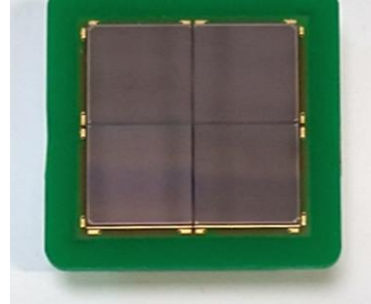

Tile 3x3 (LG-SiPM) 8 ch.

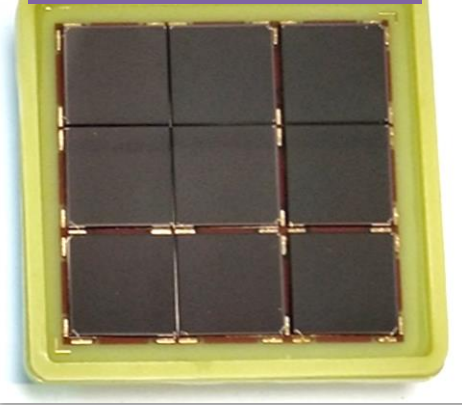

Pos. Res. tests: RGB-HD LG-SiPM

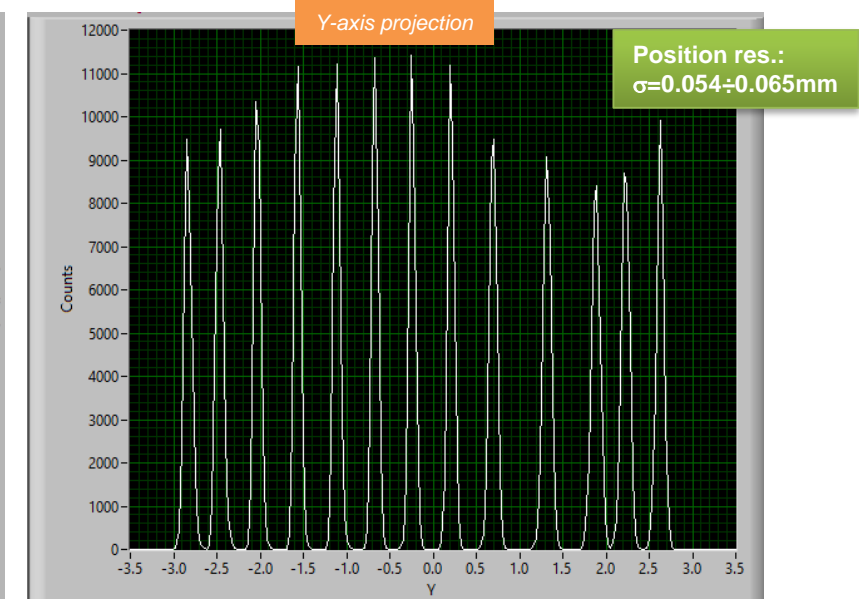
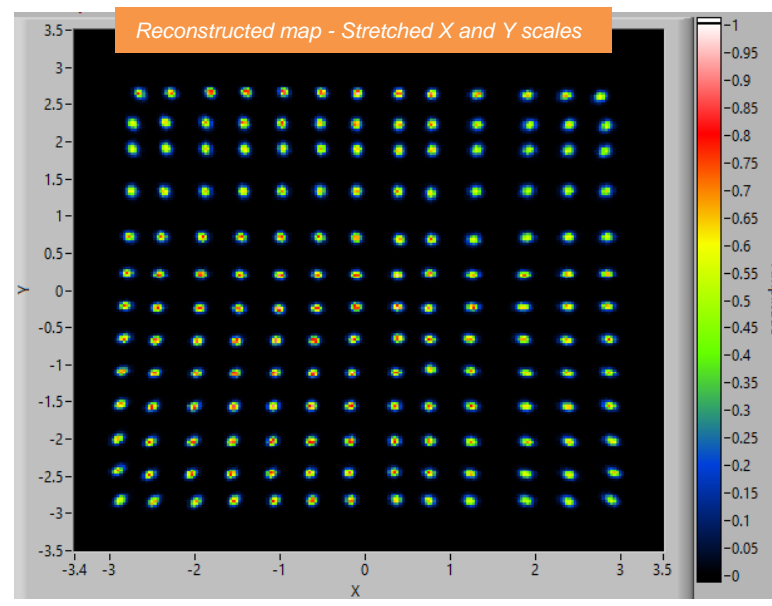
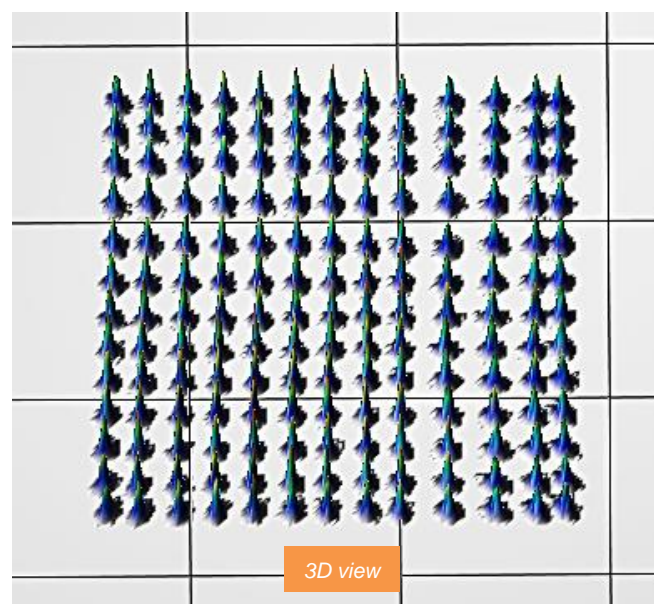
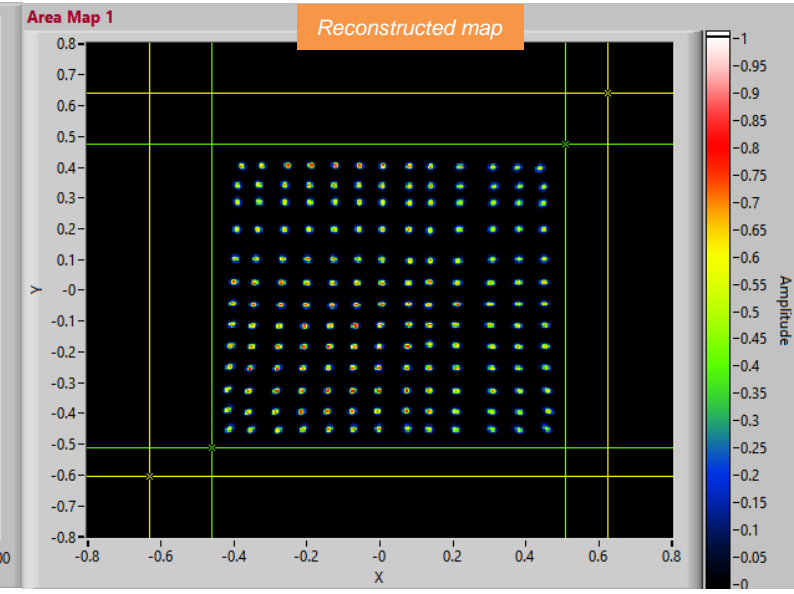
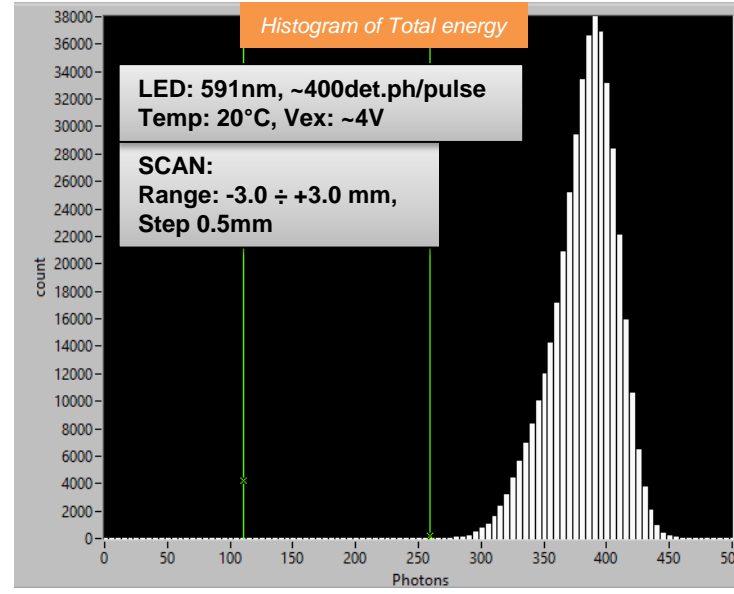
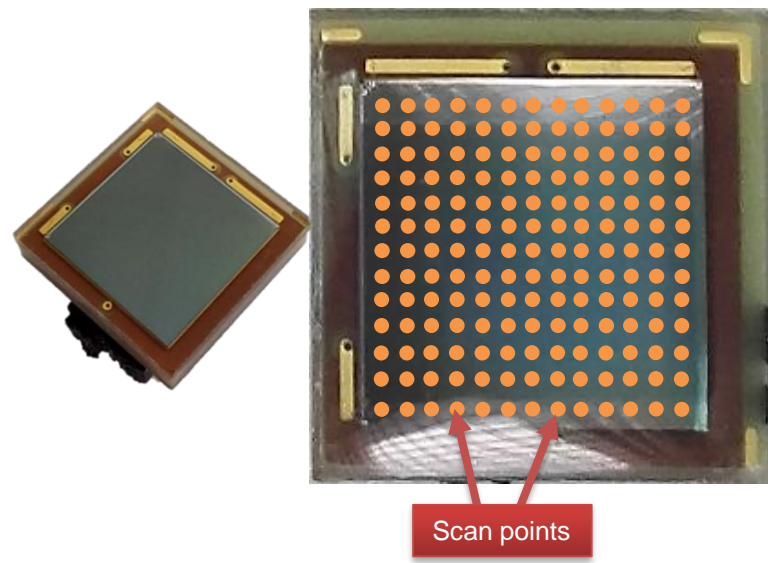

Pos. Res. tests: RGB-HD LG-SiPM TILE 2x2

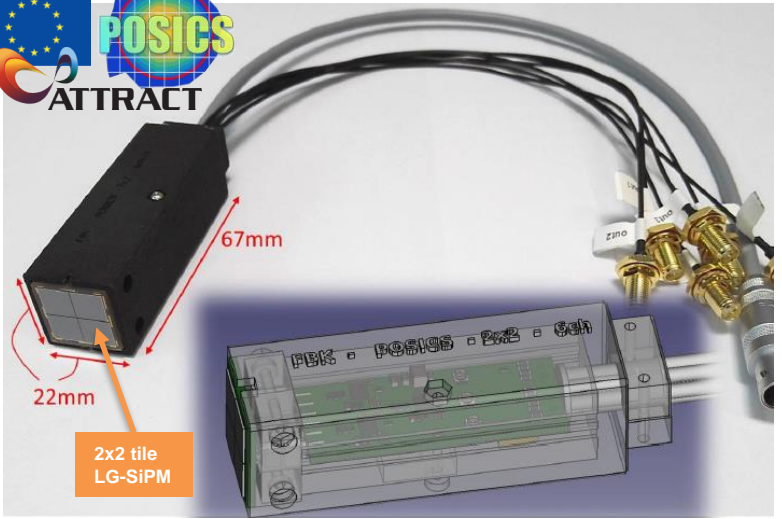

2x2 Tile of LG-SiPM (with only 6 channels), in a compact module

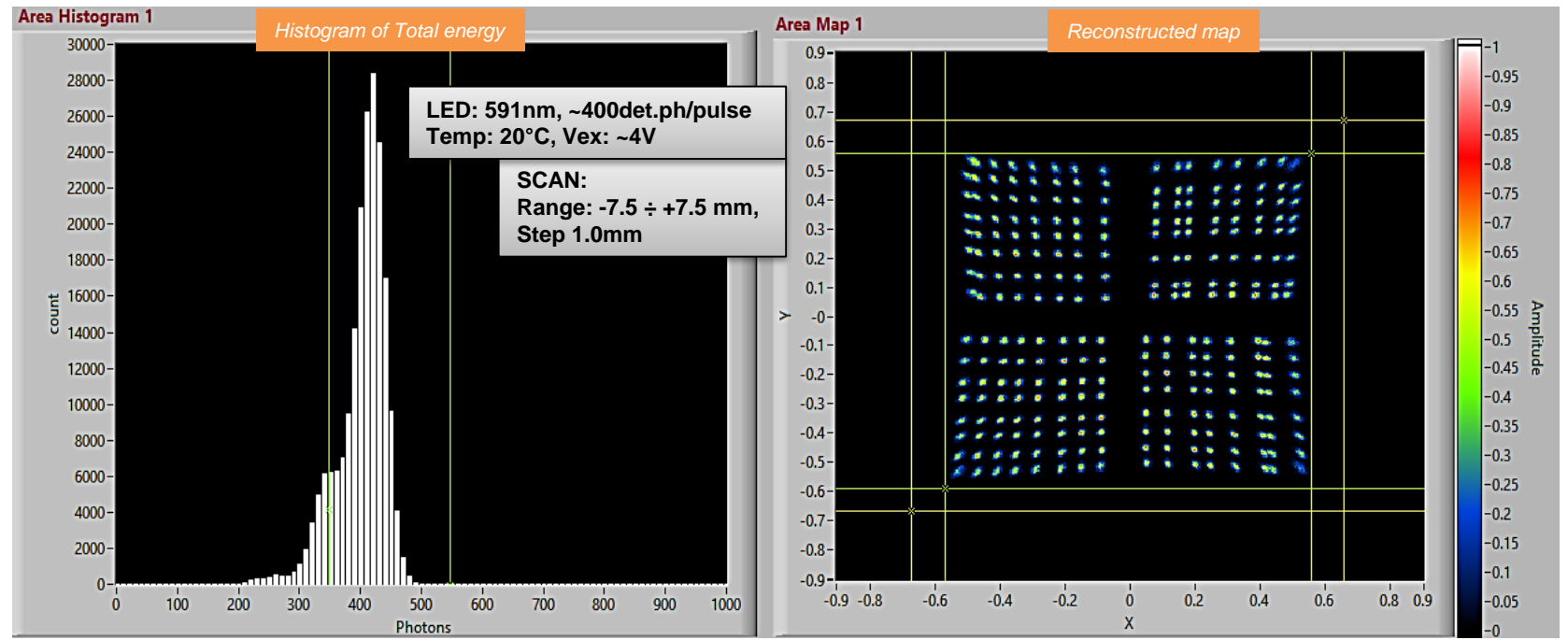

- **Effect of SiPM noise** when increasing temperature: worsening of the position resolution

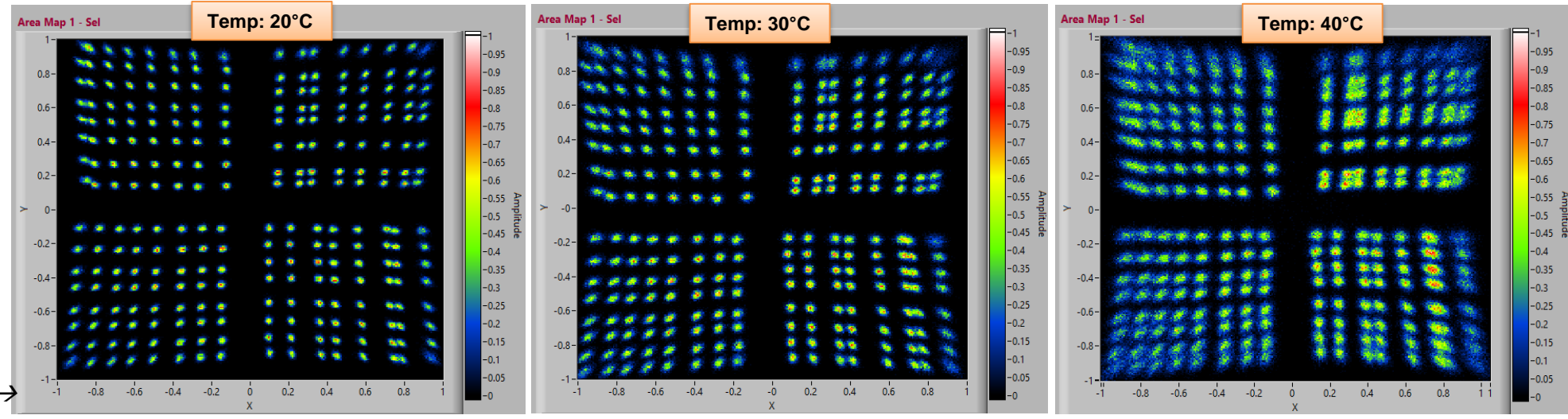

Normalized X and Y scales →

Pos. Res. tests: NUV-HD LG-SiPM

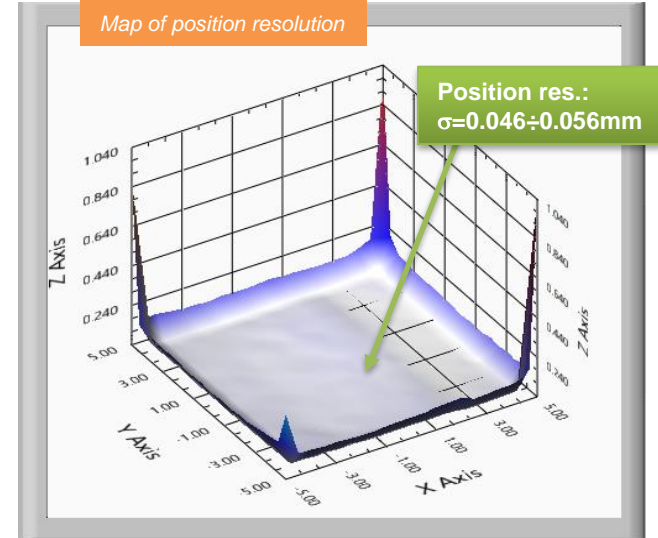
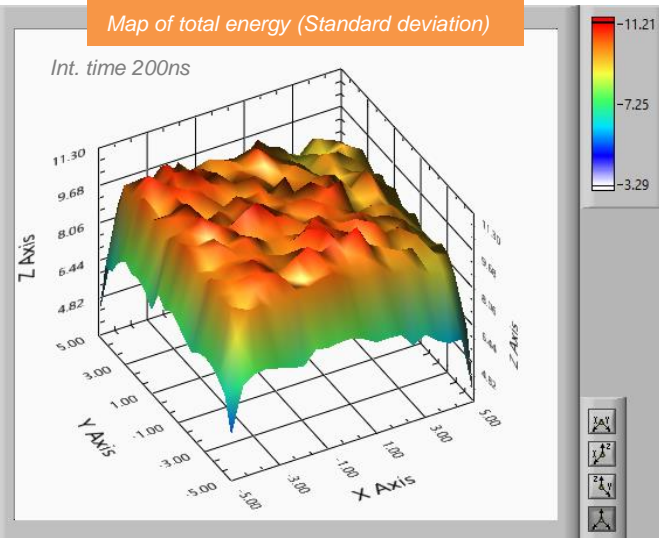
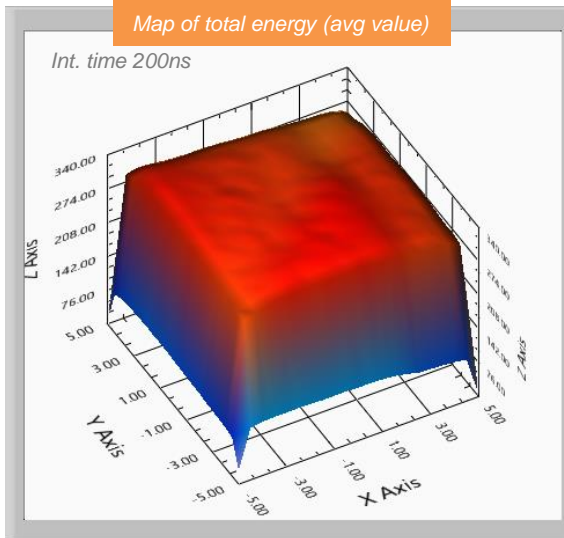
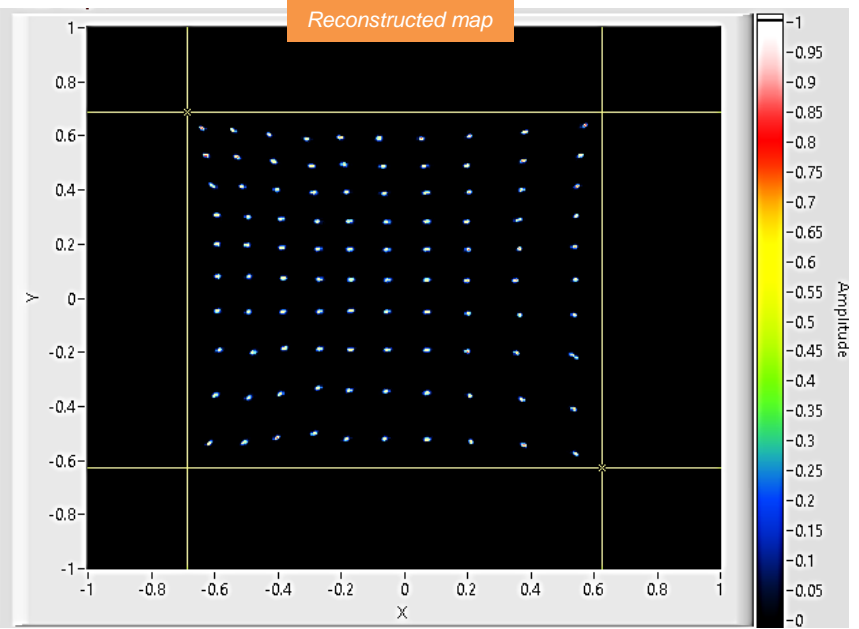
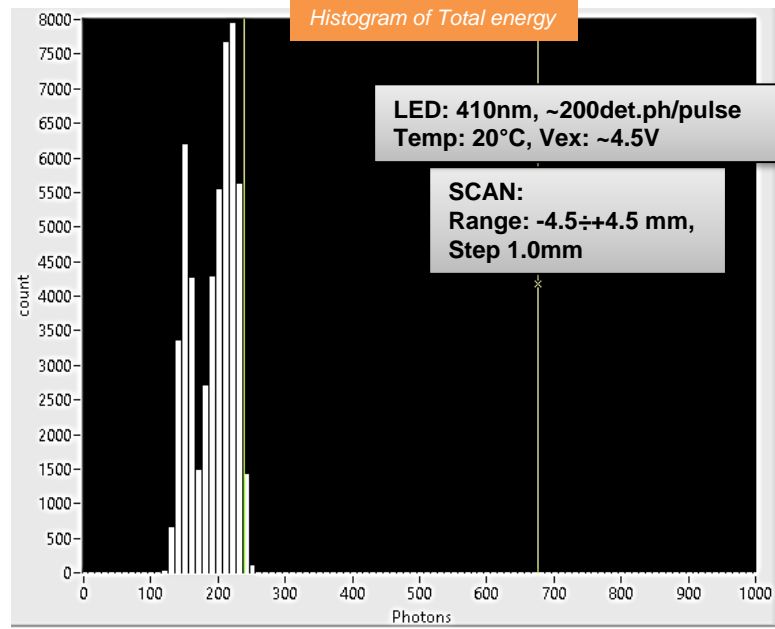
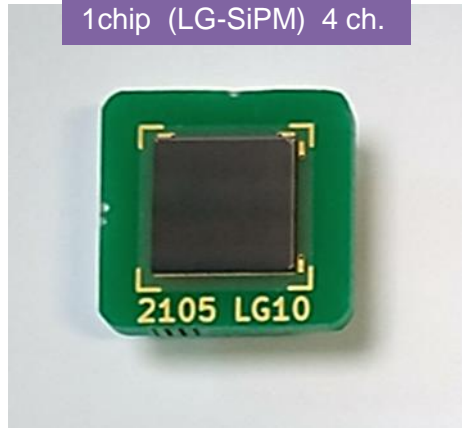

1 chip (LG-SiPM) 4 ch.

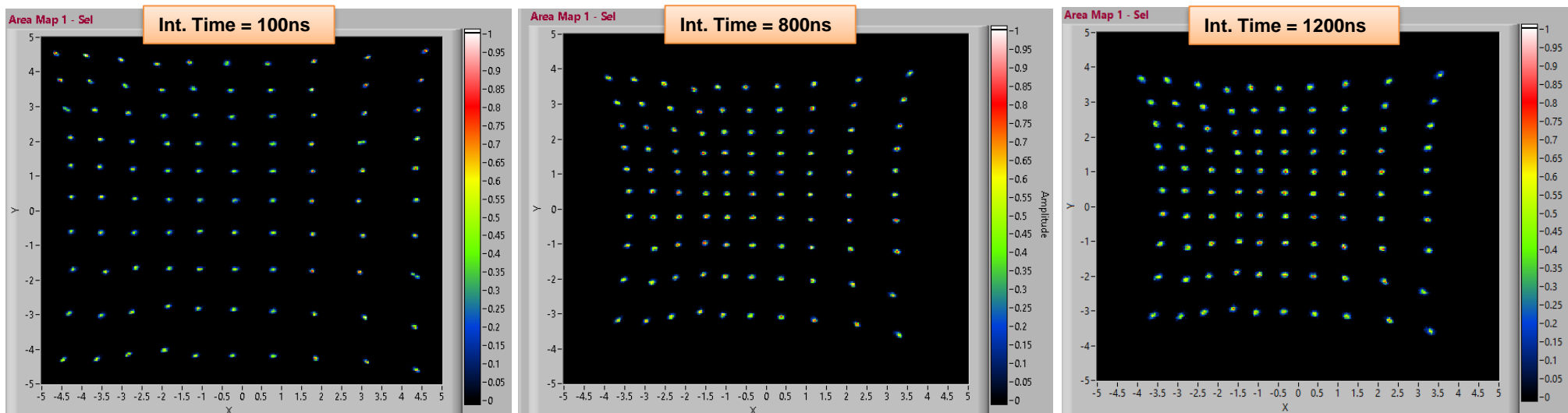

- **Small pincushion effect** on reconstructed map.
- Worse when increasing integration time.
(Note: no corrections in our measurements)
- Might be related to parasitic inductances in the large-area SiPM chips, combined with non-zero input impedance of readout electronics.
- SPICE simulation will be performed to better understand the issue.

Pincushion Distortion Correction in Position-Sensitive Avalanche Photodiodes
DOI: 10.1109/NSSMIC.2005.1596732

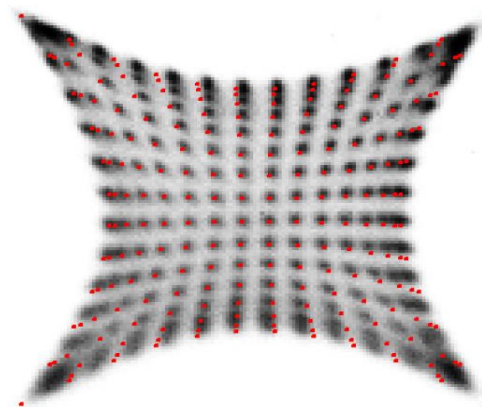
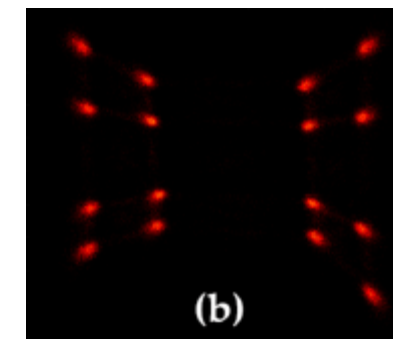

Fig. 3. The raw ^{99m}Tc flood image of the crystal array with superposed dots obtained from simulation (red dots).

Evaluation of Large-Area Silicon Photomultiplier Arrays for Positron Emission Tomography Systems

DOI: 10.3390/electronics10060698

Unideal signal source output impedance and DPC termination impedance are potential sources of the pincushion distortion and resolution degradation at the edges and corners



Pos. Res. tests: NUV-HD LG-SiPM TILE 2x2

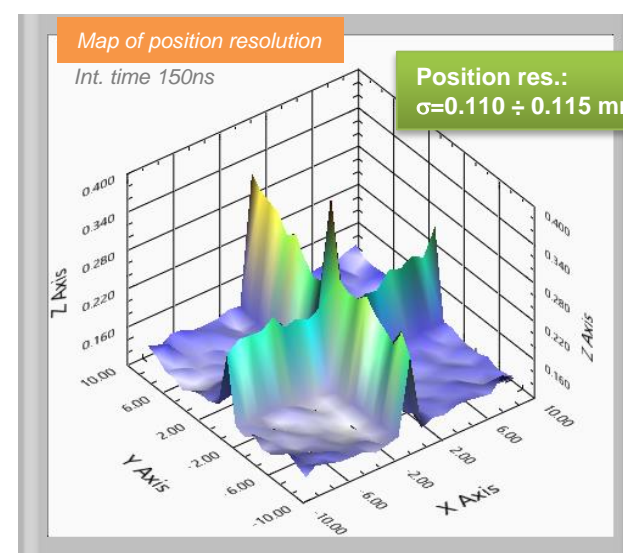
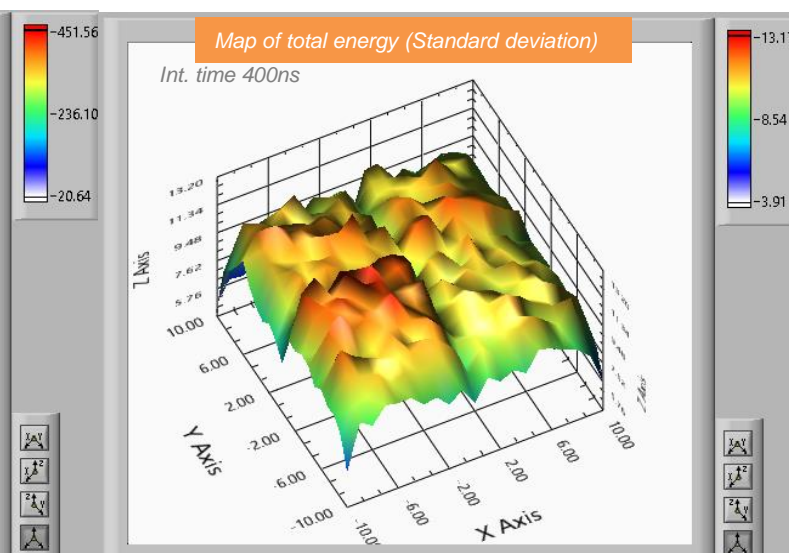
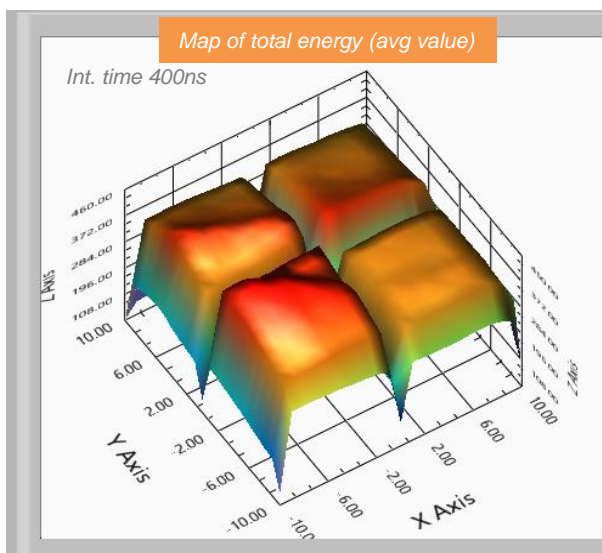
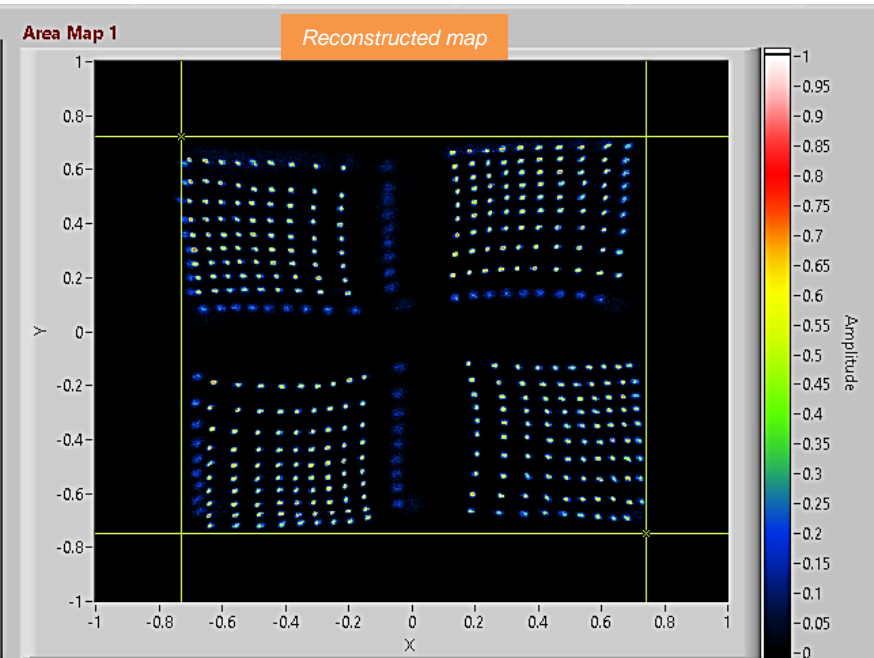
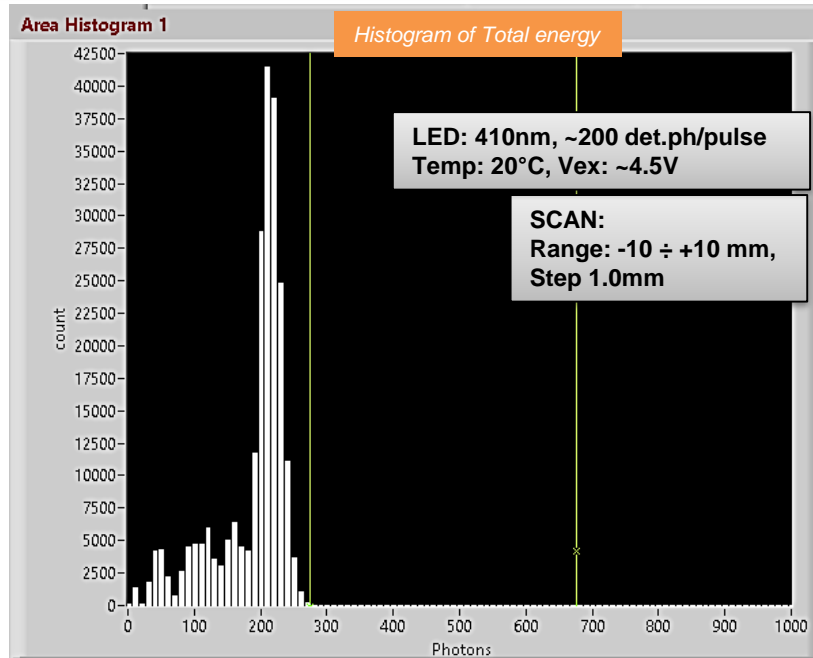
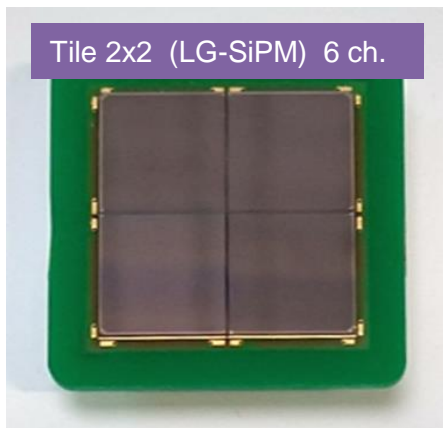

NUV-HD LG-SiPM TILE 3x3 → compact gamma camera



POSICS-2 project

- POSICS aims at realizing a cheap, handle-able, wireless, compact and light gamma camera, for Radio-Guided-Surgery (RGS).
- Based on LG-SiPM 3x3 array
→ reduced #channels
→ low-power consumption
- Breakthrough approach in the intra-operative practice, moving away from the current probe approach.

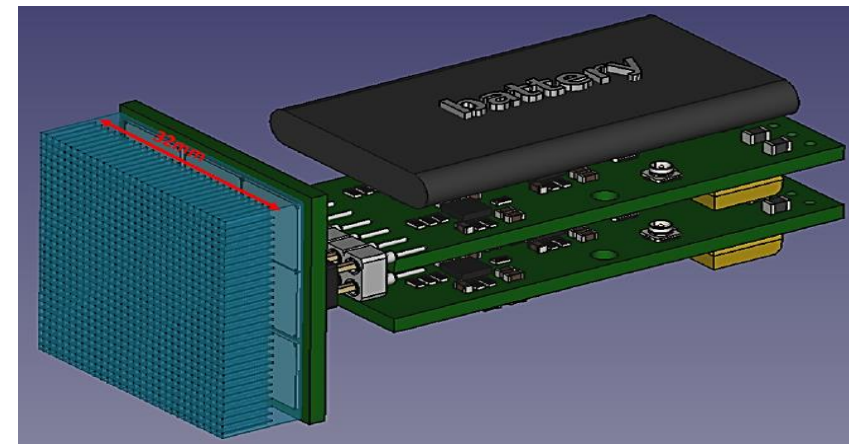

NUV-HD LG-SiPM TILE 3x3 → compact gamma camera



LED: 410nm, ~400 det.ph/pulse
Vex = 4V
SCAN:
Range: -14.25 ÷ +14.25 mm, Step 1.5mm

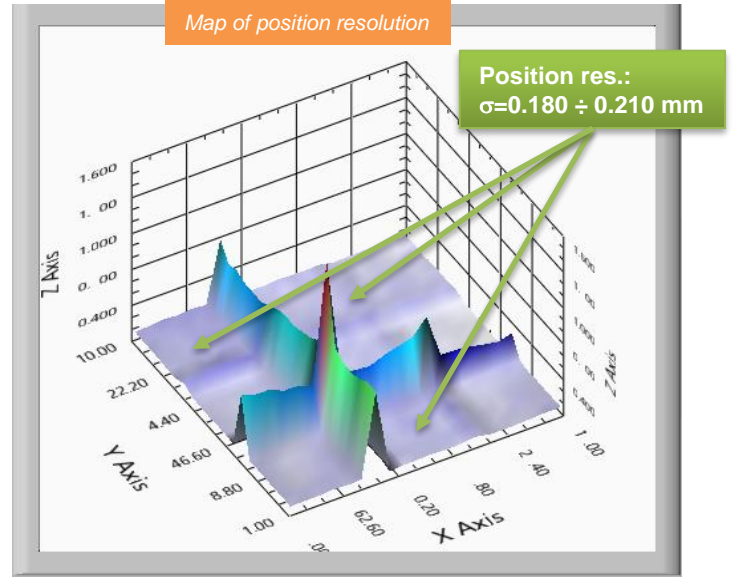
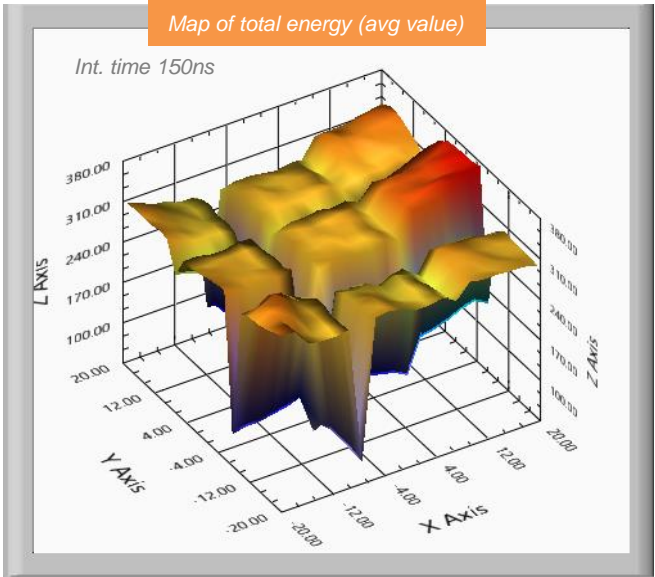
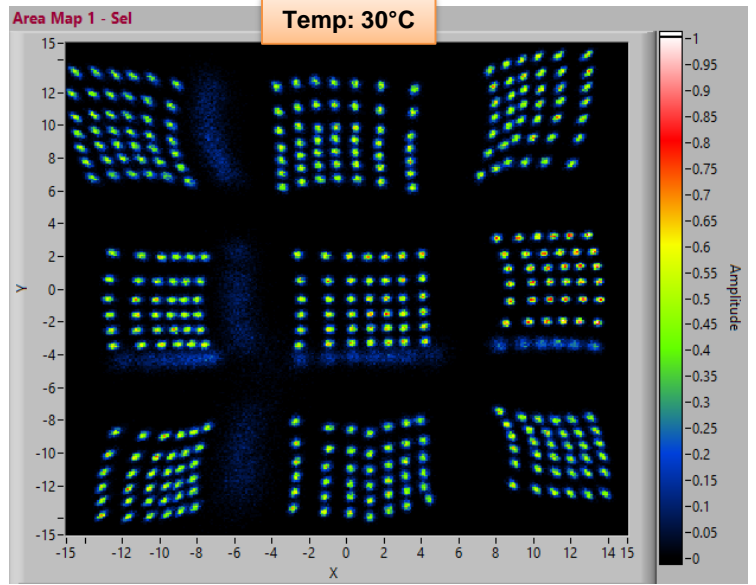
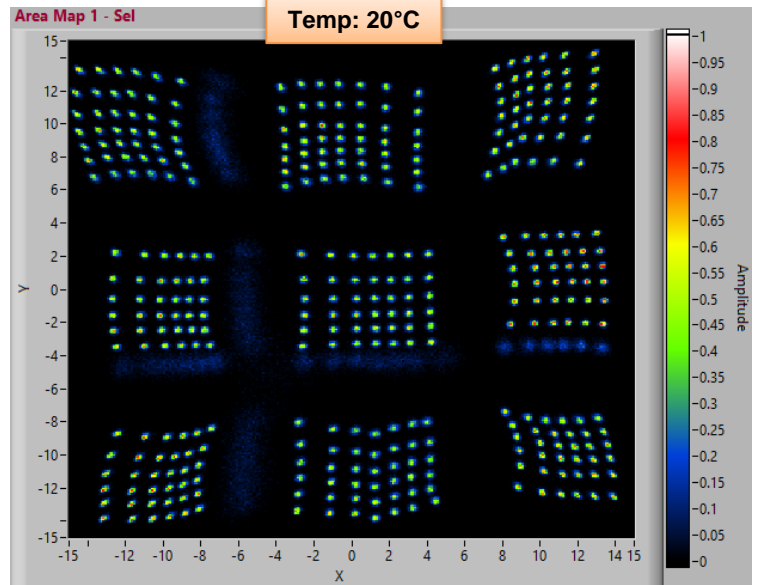
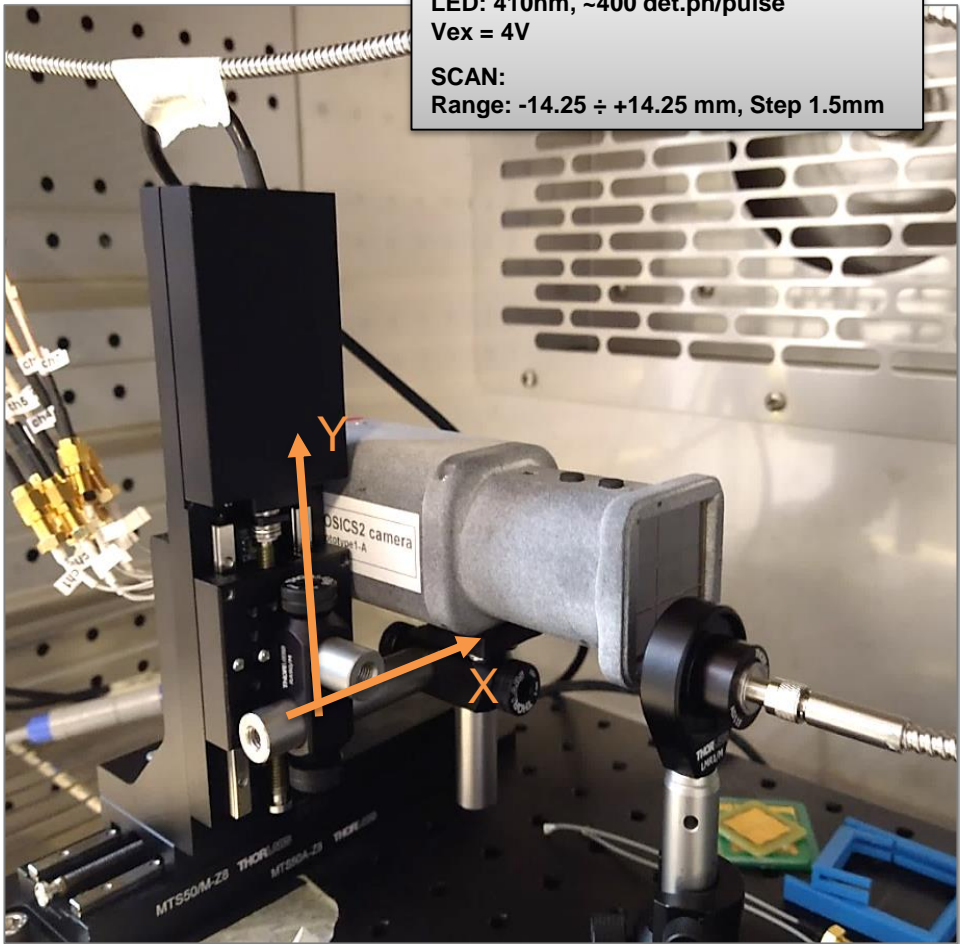

Conclusions

- We developed and improve the FBK LG (position sensitive) SiPM technology
 - **New NUV-sensitive large-area (10x10mm²) devices**
 - 1D and 2D position sensitive version
- Development of **“smart” channel-reduction scheme**
 - Only 6 output channels for 2x2 tiles of SiPMs
 - Only 8 output channels for 3x3 tiles of SiPMs
 - Still preserving <0.5mm position resolution
- Functional characterization:
 - PDE: peaked at 410nm, reaching 45% at 4V, 55% at 8V excess bias.
- **Good position resolution**, also when SiPM chip combined in TILES
 - Position resolution $\sigma = \sim 0.05$ mm for 1 SiPM chip (10x10mm²)
 - Position resolution $\sigma = \sim 0.12$ mm for 2x2 SiPM tile (tot 20x20mm²)
 - Position resolution $\sigma = \sim 0.21$ mm for 3x3 SiPM tile (tot 30x30mm²)
- LG-SiPM used in many applications, e.g. **compact gamma-camera for RGS** (POSICS project)

Large area tiles of Position-Sensitive Silicon Photomultipliers

Fabio Acerbi^a, S. Merzi^a, A. Gola^a

^a Fondazione Bruno Kessler (FBK), Center for Sensors and Devices, Trento, Italy.

acerbi@fbk.eu