

Before discussing my own work,
a review of some of the greatest mysteries in science!

Life, the Universe, and everything — the 42 most fundamental questions

Roland E. Allen and Suzy Lidström

Department of Physics and Astronomy, Texas A&M University

Physica Scripta 92, 012501 (2017), arXiv:1804.08730.

Also talk on youtube.

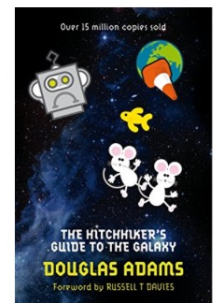
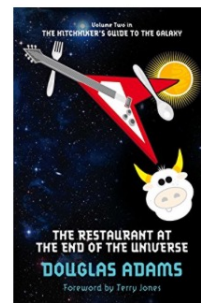
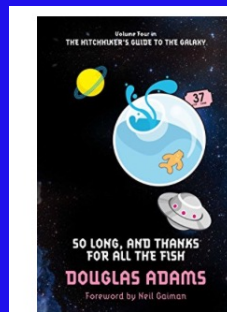
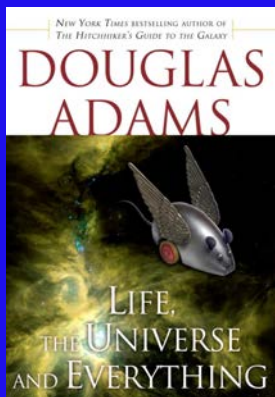

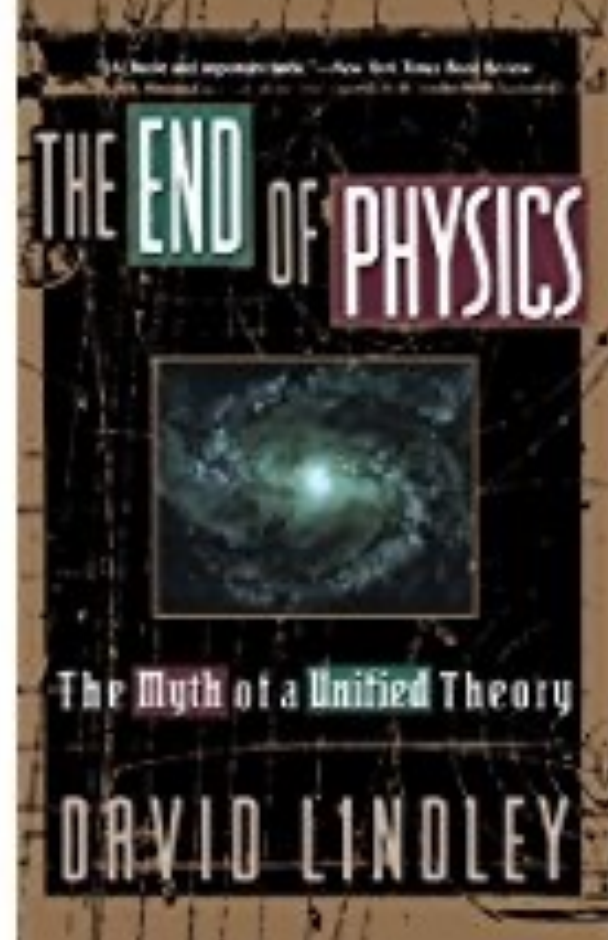
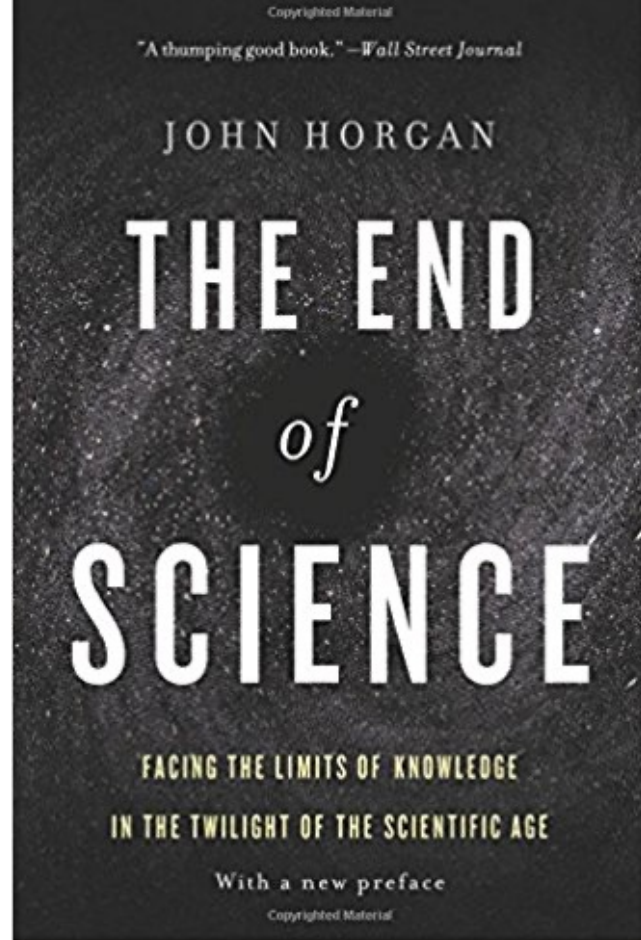

Wrong!

Young (and older) scientists have at least as much opportunity to make major contributions to human understanding as in any previous century.

But it takes hard work!



Marie Curie:

“Sometimes I had to spend a whole day stirring a boiling mass with a heavy iron rod nearly as big as myself. I would be broken with fatigue at day's end.”



Credit: <https://www.howitworksdaily.com/heroes-of-science-marie-curie/>

Jocelyn Bell Burnell:

“By the end of my PhD I could swing a sledgehammer.”

Credit: Jocelyn Bell Burnell

Although there is some glamour!



Kip Thorne and Stephen Hawking with actors David Gyasi, Anne Hathaway, Jessica Chastain, and Michael Caine at the world premiere of *Interstellar*.

Later Nobel Prize winner Kip Thorne introduced wormholes into science fiction, via a novel of Carl Sagan – *Contact* – which was also made into a movie.

42 deep questions

1. Why does conventional physics predict a cosmological constant that is vastly too large?
2. What is the dark energy?
3. How can Einstein gravity be reconciled with quantum mechanics?
4. What is the origin of the entropy and temperature of black holes?
5. Is information lost in a black hole?
6. Did the universe pass through a period of inflation, and if so how and why?
7. Why does matter still exist?
8. What is the dark matter?
9. Why are the particles of ordinary matter copied twice at higher energy?
10. What is the origin of particle masses, and what kind of masses do neutrinos have?
11. Does supersymmetry exist, and why are the energies of observed particles so small compared to the most fundamental (Planck) energy scale?
12. What is the fundamental grand unified theory of forces, and why?
13. Are Einstein relativity and standard field theory always valid?
14. Is our universe stable?

15. Are quarks always confined inside the particles that they compose?
16. What are the complete phase diagrams for systems with nontrivial forces, such as the strong nuclear force?
17. What new particles remain to be discovered?
18. What new astrophysical objects are awaiting discovery?
19. What new forms of superconductivity and superfluidity remain to be discovered?
20. What further properties remain to be discovered in highly correlated electronic materials?
21. What new topological phases remain to be discovered?
22. What other new phases and forms of matter remain to be discovered?
23. What is the future of quantum computing, quantum information, and other applications of entanglement?
24. What is the future of quantum optics and photonics?
25. Are there higher dimensions, and if there is an internal space, what is its geometry?
26. Is there a multiverse?
27. Are there exotic features in the geometry of spacetime, perhaps including those which could permit time travel?
28. How did the universe originate, and what is its fate?

29. What is the origin of spacetime, why is spacetime four-dimensional, and why is time different from space?
30. What explains relativity and Einstein gravity?
31. Why do all forces have the form of gauge theories?
32. Why is Nature described by quantum fields?
33. Is physics mathematically consistent?
34. What is the connection between the formalism of physics and the reality of human experience?
35. What are the ultimate limits to theoretical, computational, experimental, and observational techniques?
36. What are the ultimate limits of chemistry, applied physics, and technology?
37. What is life?
38. How did life on Earth begin -- and how did complex life originate?
39. How abundant is life in the universe, and what is the destiny of life?
40. How does life solve problems of seemingly impossible complexity?
41. Can we understand and cure the diseases that afflict life?
42. What is consciousness?

1. Why does conventional physics predict a cosmological constant that is vastly too large?

As emphasized by **Steven Weinberg**, according to standard physics, the vacuum energy should act as a gravitational source -- effectively an enormous cosmological constant. It should then have an enormous effect on the curvature of spacetime, roughly 120 orders of magnitude larger than is compatible with observation.



3. How can Einstein gravity be reconciled with quantum mechanics?



The theorists shown above are among the major leaders in the long quest for a quantum theory of gravity (and fundamental understanding of other forces and particles).

4. What is the origin of the entropy and temperature of black holes?



Stephen Hawking plays tag with an emu on a Texas ranch.

Credit: Hans Schuessler.

John Wheeler invented the terms “black hole”, “wormhole”, “quantum foam”, and “neutron moderator”, and made many important contributions to gravitational and nuclear physics. He is shown here at age 4.



Credit: AIP Emilio Segre Visual Archives, Wheeler Collection.

One would like a derivation of the black hole entropy from the counting of microstates, as inscribed on Ludwig Boltzmann's gravestone.

But so far there is no such general or convincing derivation of the extremely simple results of Bekenstein and Hawking:

$$S_{BH} = \frac{1}{4} \frac{A}{\ell_P^2}$$

$$T_H = \frac{\kappa}{2\pi}$$

Once again, it appears that some major principle has been missed.

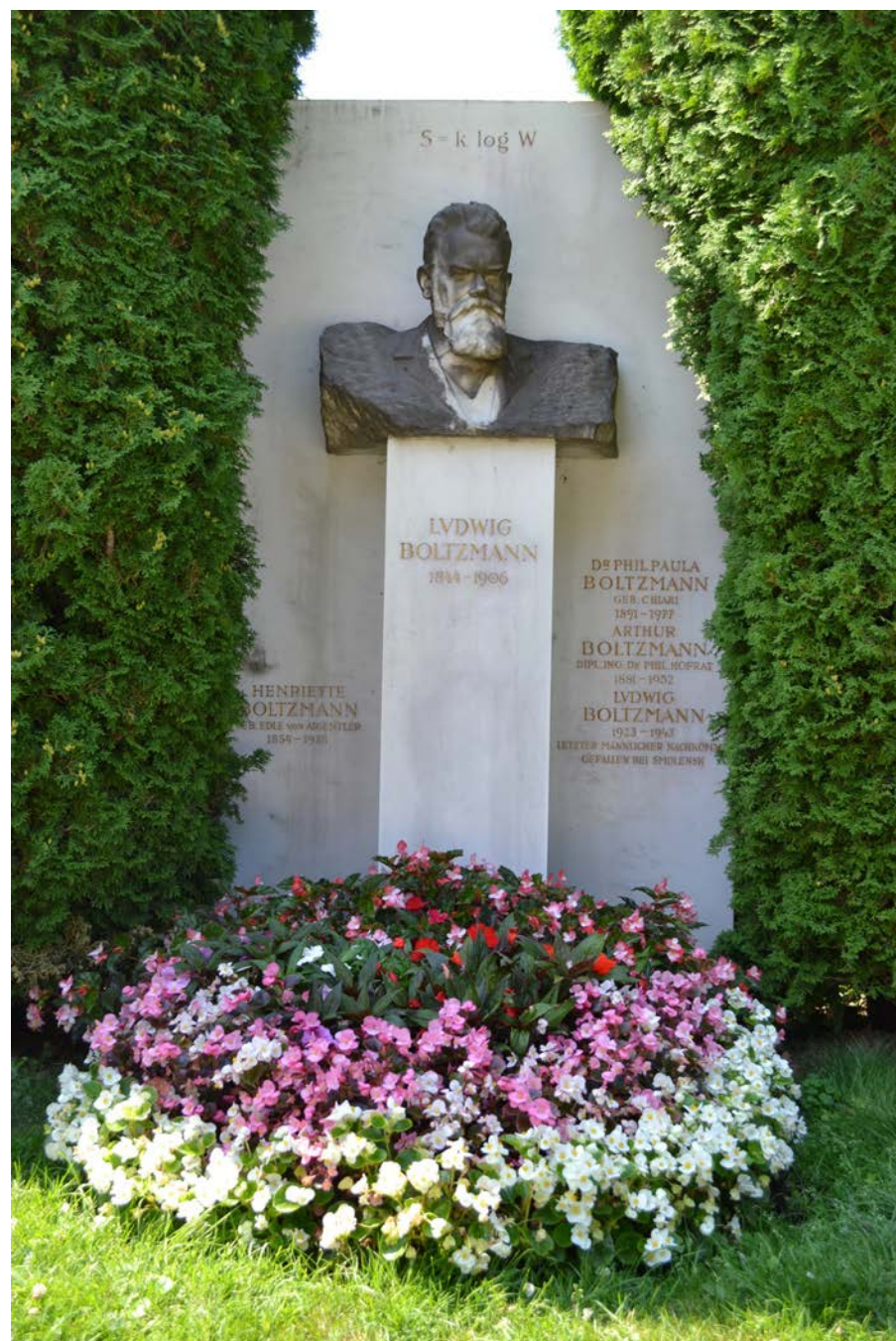

6. Did the universe pass through a period of inflation, and if so how and why?

Cosmic microwave background
Seen by ESA Planck
space-based observatory

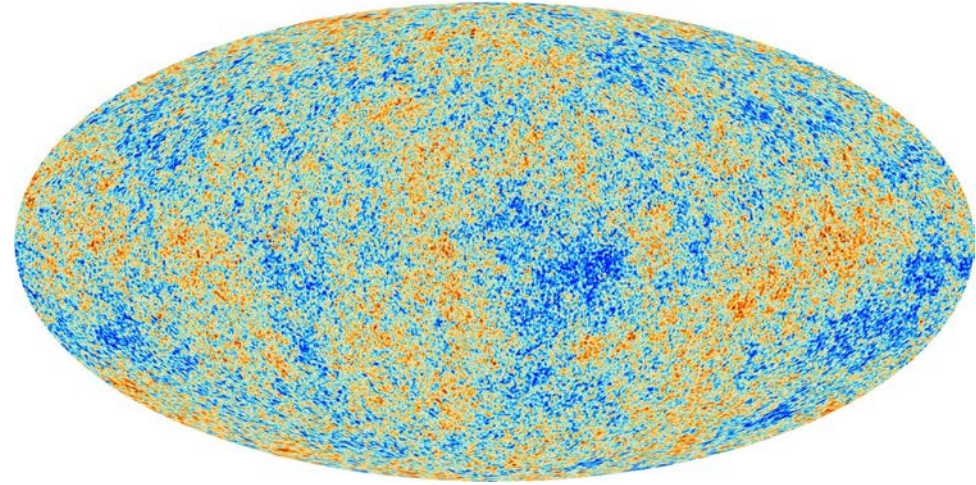

7. Why does matter still exist?

Among Andrei Sakharov's many contributions to applied and fundamental physics are the Sakharov criteria for baryogenesis, which are key to understanding how matter survived after the extreme conditions of the Big Bang.

But the origin of the required CP violation is still not understood, and requires new physics.

8. What is the dark matter?



Fritz Zwicky

Credit: <http://www.astro.caltech.edu/palomar/about/timeline.html>



Vera Rubin

Credit: Archives and Special Collections, Vassar College Library

Despite increasingly powerful attempts to detect dark matter, via **terrestrial collisions with atomic nuclei**, **emission of particles from extraterrestrial dark matter annihilations**, and **production of dark matter particles in accelerator laboratories**, the composition of dark matter is still unknown.

Who will solve these problems?



Twelve prizewinning Swedish school girls on a visit to the Institut Laue-Langevin in Grenoble. Their guide, centre front, was from Gabon. The girls' parents were born in Finland, Iran, Iraq, Poland and Sweden. During their visit they met or were accompanied by English, French, Icelandic, Italian, Russian, and Swedish scientists. (One of the authors, Suzy Lidström, is at the upper right, as the organizer of the program at Uppsala University.)

A new perspective on some current mysteries, including dark matter, dark energy, and black hole entropy

Roland E. Allen

Department of Physics and Astronomy, Texas A&M University

John Wheeler conjectured that physics is fundamentally based on bits and the act of observation. The present theory differs by starting with dits, which can assume any of d states, and which have physical reality apart from any observer. D of the states correspond to coordinates and the rest to fields.

After many nontrivial steps (and novel ideas), we regain all of standard physics, but with a resolution of some long-standing theoretical problems, and new features such as an extended Higgs sector that contains an ideal dark matter candidate.

This particle should be observable within the next few years in direct-detection experiments (XENONnT, LZ, and PandaX), and in ~ 15 years at the high-luminosity LHC. There is a strong case that it has already been detected in the gamma rays observed by Fermi-LAT and antiprotons observed by AMS-02.

The present theory addresses many fundamental issues, including the following:

origin of dark matter

origin of the Bekenstein-Hawking entropy of black holes

the relatively tiny size of the cosmological constant

why spacetime is 4-dimensional with one time coordinate

why gravitational singularities are acceptable

regularization of quantum gravity near the Planck scale

origin of gravitational and gauge interactions

action of fermionic and bosonic fields

action of gravitational and gauge fields

origin of quantum fields

origin of spacetime coordinates.

There is time to discuss only two of these here: **dark matter and **the Bekenstein-Hawking entropy of black holes**. **I will send the complete paper upon request, and discussions here and elsewhere are welcome.****

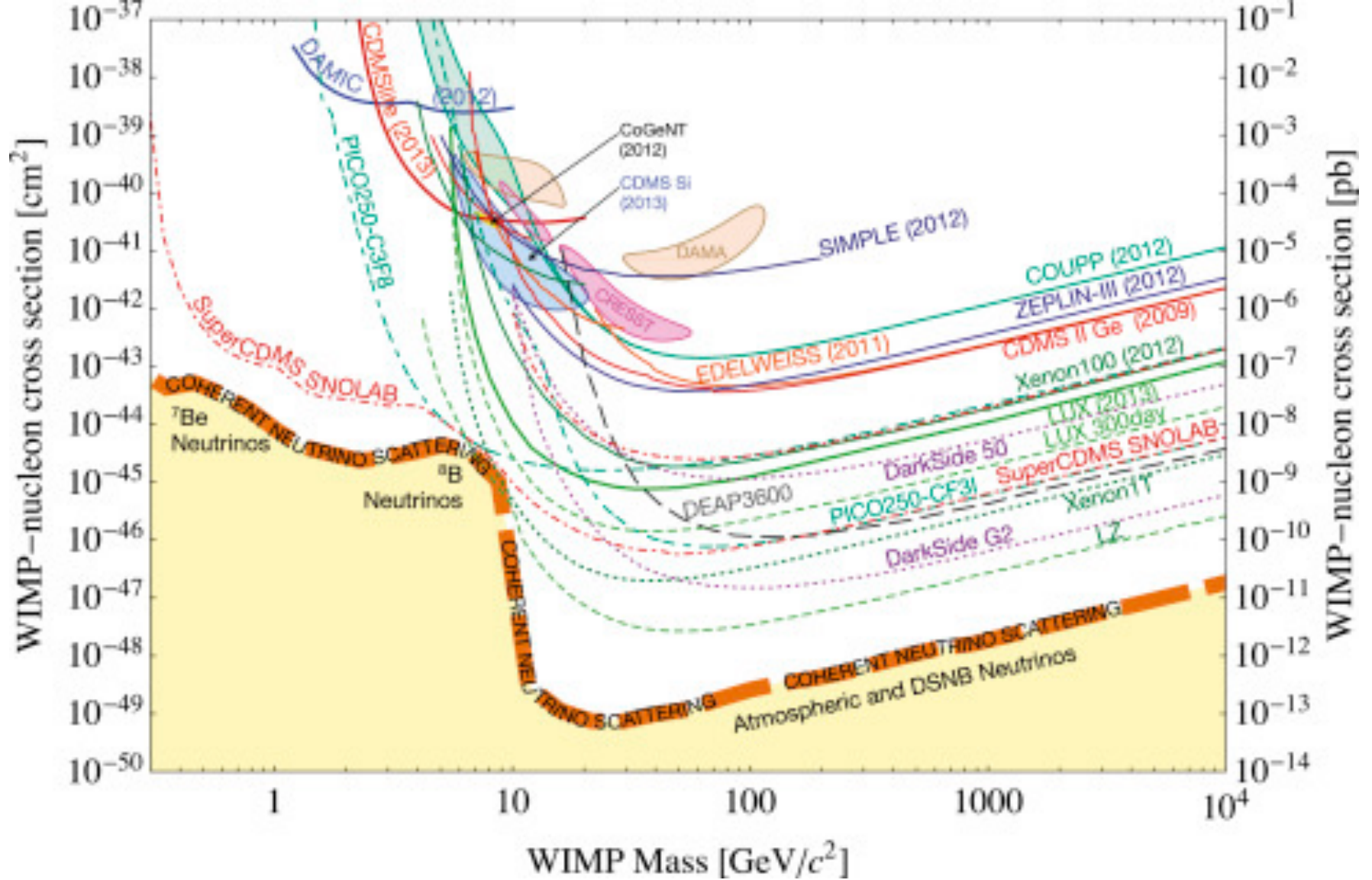

Our dark matter candidate has a cross-section for direct detection estimated to be slightly above 10^{-48} cm^2 , with a mass of about $70 \text{ GeV}/c^2$. It is therefore potentially detectable by LZ and Xenon nT, which have begun taking data and estimate a sensitivity $\sim 1.4 \times 10^{-48} \text{ cm}^2$.

Figure credit -- J. Billard, L. Strigari, E. Figueroa-Feliciano, Phys. Rev. D, 89, 023524 (2014), [arXiv:1307.5458](https://arxiv.org/abs/1307.5458).

The history of spin 1/2 fermions begins with the discovery of the electron in 1897 by J. J. Thomson.

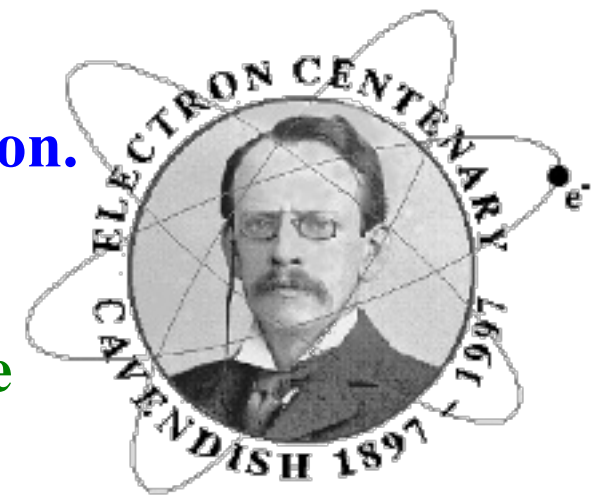

The history of spin 1 gauge bosons begins with the 1905 paper of Einstein which introduced the photon.

A spin 0 boson is something new (2012), and surprises may *again* lie ahead!

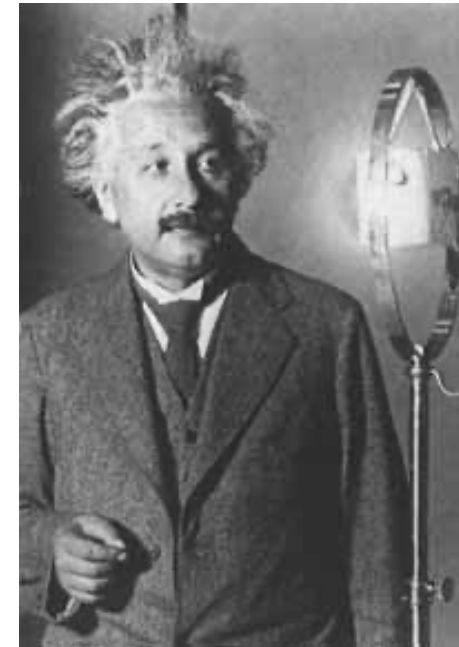

The present theory involves an extended Higgs sector.

In the present theory, there are two kinds of scalar boson fields that are formed by the combination of more primitive spin $\frac{1}{2}$ fields.

The scalar (spin 0) Higgs fields ϕ_R are formed from two primitive spin $\frac{1}{2}$ fields with the same quantum numbers and opposite spin:

$$\tilde{\Phi}_R = \begin{pmatrix} \tilde{\Phi}_r \\ \tilde{\Phi}_{r'} \end{pmatrix} = \phi_R(x) \xi_R \quad \text{with} \quad \xi_R^\dagger \xi_R = 1$$

[They are somewhat analogous to the Higgs/amplitude modes in superconductors: P. B. Littlewood and C. M. Varma, Phys. Rev. B. 26, 4883 (1982).]

The scalar higgson fields φ_i are formed from two primitive spin $\frac{1}{2}$ fields with opposite quantum numbers:

$$\Phi_S = \frac{1}{\sqrt{2}} \begin{pmatrix} \Phi_s \\ \Phi_s^c \end{pmatrix} \quad \text{with real parts} \quad \overline{\Phi}_s(x) = \varphi_s(x) \zeta_s, \quad \zeta_s^\dagger \zeta_s = 1.$$

Each Higgs field ϕ_R is complex and each higgson field φ_i is real. The excitations of these fields are Higgs bosons H and higgsons h .

Since the (one-component) fields associated with our dark matter candidate h^0 and related particles are derived from multicomponent Majorana-like bosonic fields with the form

$$\Phi_S = \frac{1}{\sqrt{2}} \begin{pmatrix} \Phi_s \\ \Phi_s^c \end{pmatrix}$$

they have only second-order gauge couplings [2,3]:

$$\overline{\mathcal{L}}_s^Z = -\frac{g_Z^2}{4} \varphi_s Z^\mu Z_\mu \varphi_s \quad , \quad \overline{\mathcal{L}}_s^W = -\frac{g^2}{2} \varphi_s W^{\mu+} W_\mu^- \varphi_s \quad .$$

This is why the present candidate (unlike e.g. those of natural supersymmetry) is consistent with the current limits from direct detection, indirect detection, and collider detection experiments, and with the observed relic abundance of dark matter.

[1] Reagan Thornberry, Maxwell Throm, John Killough, Dylan Blend, Michael Erickson, Brian Sun, Brett Bays, Gabriel Frohaug, and Roland E. Allen “Experimental signatures of a new dark matter WIMP”, EPL [European Physics Letters] 134, 49001 (2021), arXiv:2104.11715 [hep-ph].

[2] Caden LaFontaine, Bailey Tallman, Spencer Ellis, Trevor Croteau, Brandon Torres, Sabrina Hernandez, Diego Cristancho Guerrero, Jessica Jaksik, Drue Lubanski, and Roland E. Allen, “A Dark Matter WIMP That Can Be Detected and Definitively Identified with Currently Planned Experiments”, Universe 7, 270 (2021), arXiv:2107.14390 [hep-ph].

The concept of entropy — Clausius, Boltzmann, Gibbs, von Neumann, Bekenstein, Hawking, Gibbons, ...

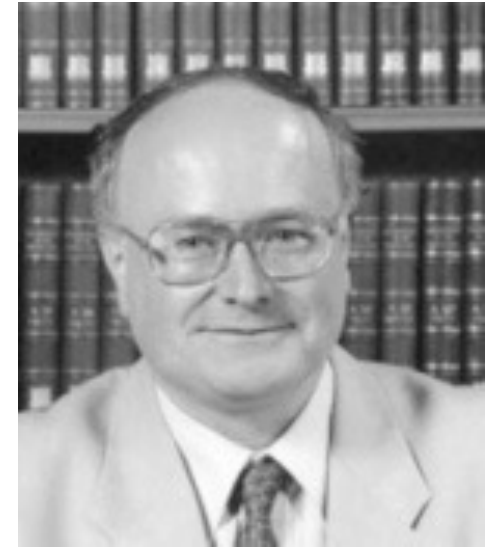
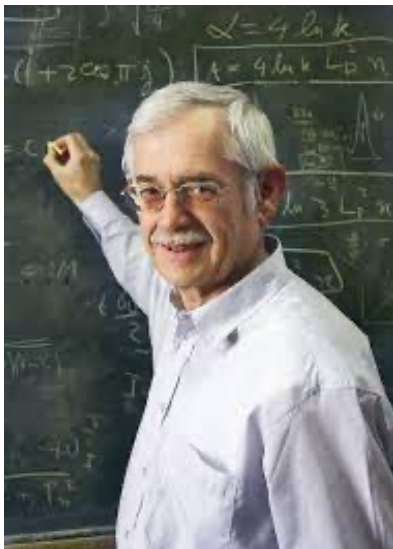
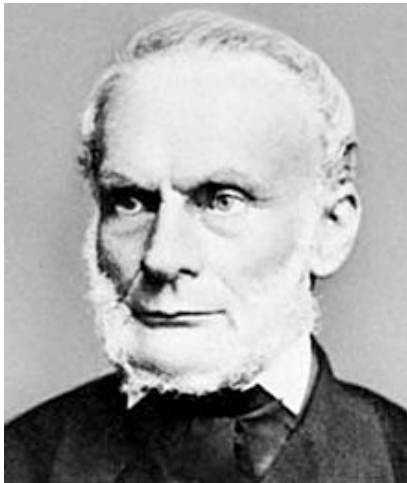

$S = k \log W$, W = number of available microstates

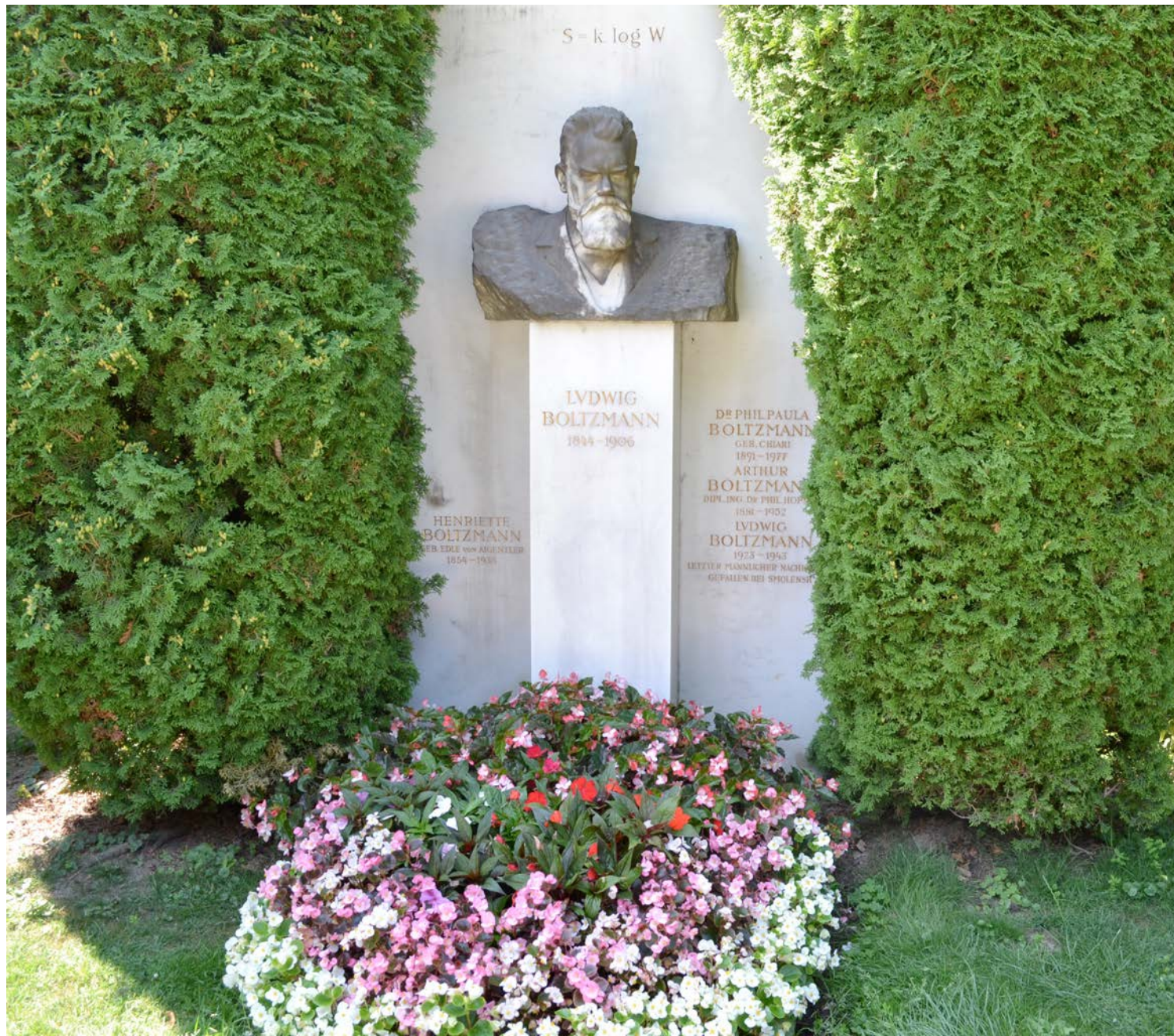

There have been many attempts to explain the Bekenstein-Hawking entropy of black holes in terms of microstates, principally with string theory, but also loop quantum gravity, etc.

None of these attempts are convincing.

The complicated arguments and unphysical results stand in remarkable contrast to the simplicity and generality of the Bekenstein-Hawking entropy and the related work of Hawking, Gibbons, Penrose, Wheeler, and others in the relativity community.

And there has still been no success for even the simplest case of a Schwarzschild black hole (or any realistic black hole).

Gibbons and Hawking obtained an expression for the Euclidean action of a black hole which is exactly the same as the Bekenstein-Hawking entropy needed to explain the Hawking radiation:

$$S = k \frac{A}{4\ell_P^2} \quad \text{where } \ell_P = \text{Planck length}$$

which yields the Hawking temperature $T_H = \frac{\kappa}{2\pi}$

where κ is the surface gravity (at the event horizon)

in natural units ($\hbar = c = G = k = 1$).

See G.W. Gibbons and S.W. Hawking, Physical Review D 15, 2752 (1977) and G.W. Gibbons, Physics Letters 61A, 3 (1977).

A fundamental mystery remains, however: Why should the Euclidean action be interpreted as an entropy?

In other words, what are the microstates which are presumably being counted?

In the present theory

$$S_L = -S$$

where S_L is the **Lorentzian action** of any field and S is the **entropy** of the fundamental objects that account for these fields – the dits.

The Lorentzian action has the form

$$S_L = \int dt (T - V)$$

and the Euclidean action the form

$$S_E = \int dt (T + V)$$

where T represents the terms with time derivatives. Then for a static system we have

$$\boxed{S_E = S}.$$

In the present theory, therefore, the Euclidean action S_E of any static system is an entropy, initially determined by counting the microstates of dits.

The action of a rotating black hole contains an additional contribution from the angular momentum, with the same expression for the entropy.

When this fact is combined with the result of Gibbons and Hawking, the Bekenstein-Hawking entropy and Hawking temperature are automatically explained for all black holes.

Essential points for the dark matter particle predicted by the present theory:

Our recently proposed dark matter WIMP with a mass of about $70 \text{ GeV}/c^2$ has only second-order couplings to gauge bosons and itself. As a result, it has small annihilation, scattering, and creation cross-sections, and is consequently consistent with all current experiments and the observed abundance of dark matter.

These cross-sections are, however, still sufficiently large to enable detection in experiments that are planned for the near future, and definitive identification in experiments proposed on a longer time scale.

The cross-section for annihilation is consistent with thermal production and freeze-out in the early universe, and with current evidence for dark matter annihilation in analyses of the observations of gamma rays by Fermi-LAT and antiprotons by AMS-02, as well as the constraints from Planck and Fermi-LAT.

The cross-section for direct detection via collision with xenon nuclei is estimated to be slightly above 10^{-48} cm^2 , which should be attainable by LZ and XENONnT (since they estimate a sensitivity of about $1.4 \times 10^{-48} \text{ cm}^2$ for a particle in this general mass range), and perhaps PandaX and other experiments.

The cross-section for collider detection via vector boson fusion is estimated to be roughly ~ 1 femtobarn, and may be ultimately attainable by the high-luminosity LHC. Definitive collider identification may require the more powerful facilities now being proposed.

Three of the space-based studies of astrophysical phenomena:

Fermi-LAT



AMS-02



Planck

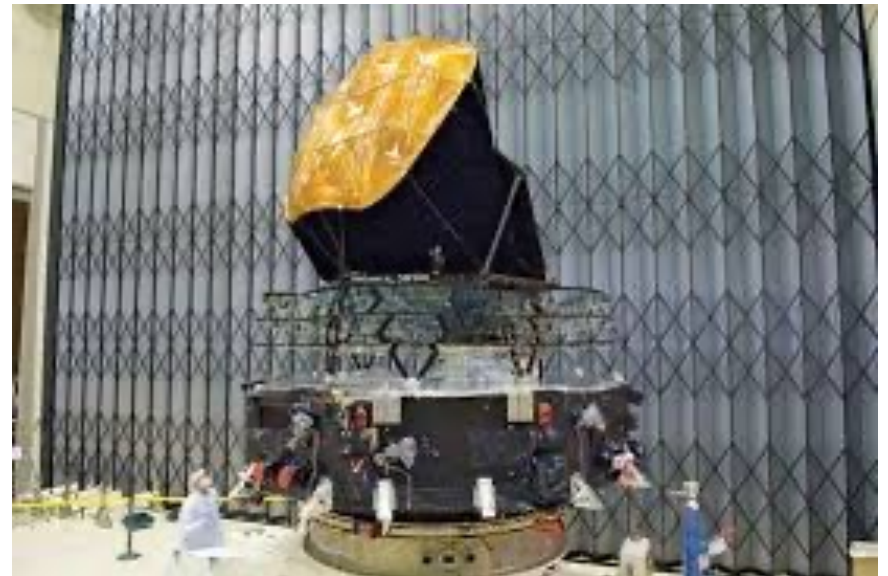

Christopher Karwin, Simona Murgia, Tim M. P. Tait, Troy A. Porter, and Philip Tanedo, Phys. Rev. D 95, 103005 (2017), arXiv:1612.05687 [hep-ph]:

“The center of the Milky Way is predicted to be the brightest region of γ -rays generated by self-annihilating dark matter particles. Excess emission about the Galactic center above predictions made for standard astrophysical processes has been observed in γ -ray data collected by the Fermi Large Area Telescope.

It is well described by the square of a Navarro, Frenk, and White dark matter density distribution. Although other interpretations for the excess are plausible, the possibility that it arises from annihilating dark matter is valid.”

“... its spectral characteristics favor a dark matter particle with a mass in the range approximately from 50 to 190 (10 to 90) GeV ... for pseudoscalar (vector) interactions.”

Rebecca K. Leane and Tracy R. Slatyer, “Revival of the Dark Matter Hypothesis for the Galactic Center Gamma-Ray Excess”, Phys. Rev. Lett. 123, 241101 (2019), arXiv:1904.08430 [astro-ph.HE]:

“... we conclude that dark matter may provide a dominant contribution to the GCE after all.”

Intriguing results from two careful analyses of AMS-02 observations of antiprotons and Fermi-LAT observations of gamma rays from the Galactic Center

Ilias Cholis, Tim Linden, and Dan Hooper, “A Robust Excess in the Cosmic-Ray Antiproton Spectrum: Implications for Annihilating Dark Matter”, Phys. Rev. D 99, 103026 (2019); arXiv:1903.02549 [astro-ph.HE]:

“This excess is well fit by annihilating dark matter particles, with a mass and cross section in the range of $m_\chi \approx 46\text{-}94$ GeV ...”

“... it is particularly intriguing that the range of dark matter models that can accommodate the antiproton excess is very similar to those which could generate the excess of GeV-scale gamma rays observed from the Galactic Center...”

Alessandro Cuoco, Jan Heisig, Lukas Klamt, Michael Korsmeier, and Michael Krämer, “Scrutinizing the evidence for dark matter in cosmic-ray antiprotons”, Phys. Rev. D 99, 103026 (2019); arXiv:1903.01472 [astro-ph.HE]:

“... strong limits on heavy DM have been derived from global CR fits. At the same time, the data have also revealed a tentative signal of DM, corresponding to a DM mass of around 40–130 GeV ...”

“This signal, if confirmed, is compatible with a DM interpretation of the Galactic center γ -ray excess ...”

The inferred masses and cross-sections in the analyses are consistent with those for the present dark matter candidate – e.g., a mass of 70 GeV/c².

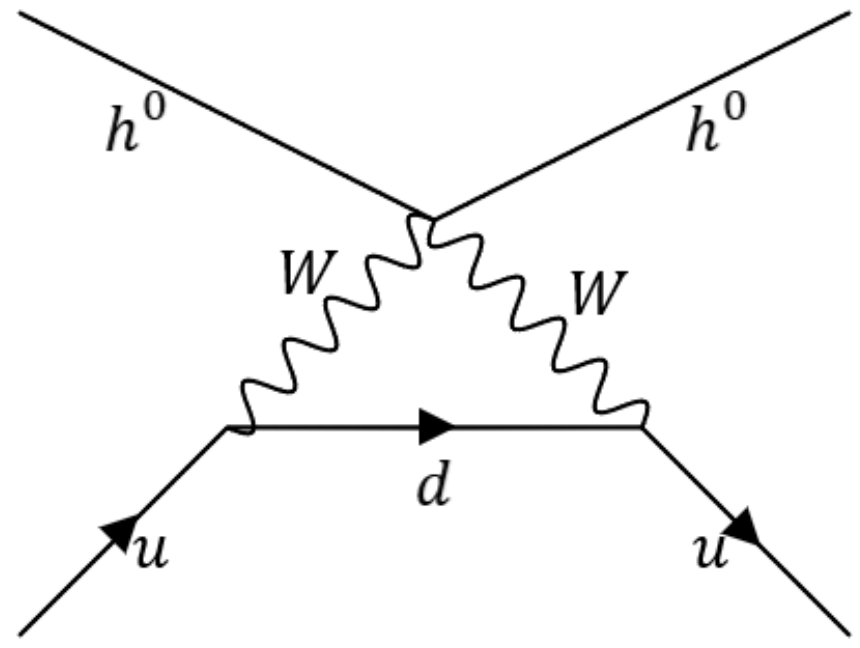
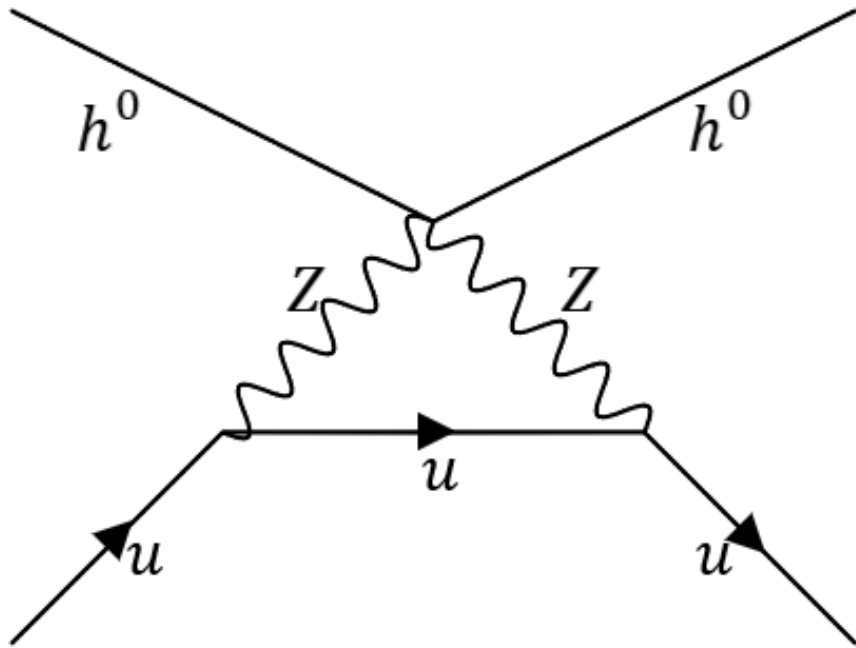

These gauge-mediated one-loop interactions appear to be the best prospect for direct detection, with a cross-section estimated to be slightly below 10^{-47} cm².

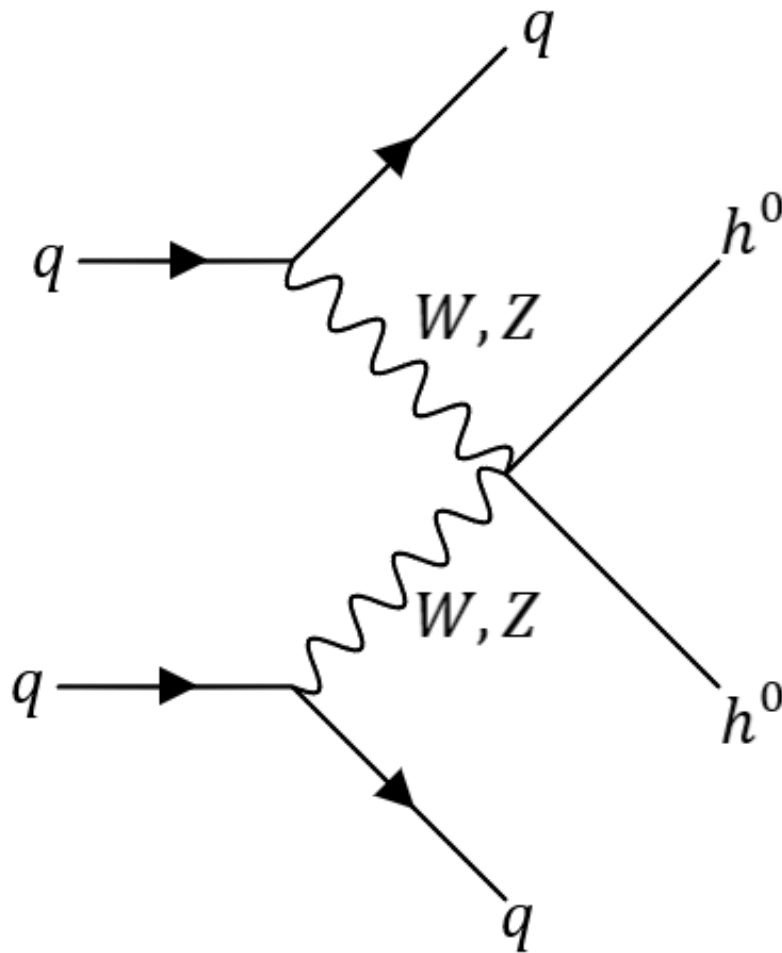

Vector boson fusion appears to be the best prospect for collider detection, with a cross-section estimated to be only ~ 1 fb, but possibly within reach of the high-luminosity LHC if it can attain 3000 fb^{-1} . The signature is ≥ 140 GeV of missing transverse energy accompanied by two jets, as shown above.

The dark matter WIMP proposed here has the following properties:

- (1) It will yield the observed dark matter abundance if its mass is about $70 \text{ GeV}/c^2$.**
- (2) The cross-section for nuclear scattering is consistent with direct-detection limits.**
- (3) The cross-section for collider production is consistent with limits from the LHC.**
- (4) The cross-section for annihilation is consistent with the limits from gamma-ray observations of dwarf spheroidal galaxies.**
- (5) The mass and annihilation cross-section are in agreement with analyses of the observations of gamma rays from the Galactic center by Fermi-LAT supporting WIMP annihilation.**
- (6) They are similarly in agreement with analyses of the antiprotons observed by AMS-02 supporting this same interpretation.**
- (7) The best hope for direct detection appears to be a one-loop process with exchange of two vector bosons, with a small but attainable cross-section.**
- (8) The most promising signature for collider detection appears to be missing transverse energy of $\geq 140 \text{ GeV}$, accompanied by two jets, following creation through vector boson fusion, with a small but ultimately attainable cross-section.**
- (9) The present dark matter particle and the lightest neutralino of supersymmetry (susy) can stably coexist in a multicomponent dark matter scenario.**

Thank you for your attention!